

Programmable Controller

**MELSEC iQ-F**  
series

## MELSEC iQ-F FX5 User's Manual (Application)

---

- FX5S CPU module
- FX5UJ CPU module
- FX5U CPU module
- FX5UC CPU module
- High-speed pulse input/output module
- Analog adapter







# SAFETY PRECAUTIONS

---

(Read these precautions before use.)

Before using this product, please read this manual and the relevant manuals introduced in this manual carefully and pay full attention to safety in order to handle the product correctly.

This manual classifies the safety precautions into two categories: [ WARNING] and [ CAUTION].

 <b>WARNING</b>	Indicates that incorrect handling may cause hazardous conditions, resulting in death or severe injury.
 <b>CAUTION</b>	Indicates that incorrect handling may cause hazardous conditions, resulting in minor or moderate injury or property damage.

Depending on the circumstances, procedures indicated by [ CAUTION] may also cause severe injury.

It is important to follow all precautions for personal safety.

Store this manual in a safe place so that it can be read whenever necessary. Always forward it to the end user.

## [DESIGN PRECAUTIONS]

---

### **WARNING**

- Make sure to set up the following safety circuits outside the PLC to ensure safe system operation even during external power supply problems or PLC failure. Otherwise, malfunctions may cause serious accidents.
    - Most importantly, set up the following: an emergency stop circuit, a protection circuit, an interlock circuit for opposite movements (such as normal vs. reverse rotation), and an interlock circuit (to prevent damage to the equipment at the upper and lower positioning limits).
    - Note that when the CPU module detects an error, such as a watchdog timer error, during self-diagnosis, all outputs are turned off. Also, when an error that cannot be detected by the CPU module occurs in an input/output control block, output control may be disabled. External circuits and mechanisms should be designed to ensure safe machinery operation in such a case.
    - Note that the output current of the 24 V DC service power supply varies depending on the model and the absence/presence of extension modules. If an overload occurs, the voltage automatically drops, inputs in the PLC are disabled, and all outputs are turned off. External circuits and mechanisms should be designed to ensure safe machinery operation in such a case.
    - Note that when an error occurs in a relay, triac or transistor of an output circuit, the output might stay on or off. For output signals that may lead to serious accidents, external circuits and mechanisms should be designed to ensure safe machinery operation in such a case.
  - Construct an interlock circuit in the program so that the whole system always operates on the safe side before executing the control (for data change) of the PLC in operation. Read the manual thoroughly and ensure complete safety before executing other controls (for program change, parameter change, forcible output and operation status change) to the PLC in operation. Otherwise, the machine may be damaged and accidents may occur due to erroneous operations.
  - In an output circuit, when a load current exceeding the current rating or an overcurrent caused by a load short-circuit flows for a long time, it may cause smoke and fire. To prevent this, configure an external safety circuit, such as a fuse.
  - For the operating status of each station after a communication failure of the network, refer to relevant manuals for the network. Incorrect output or malfunction may result in an accident.
  - At Forward/Reverse rotation limits, make sure to wire the contacts with NC, negative-logic. Wiring contacts with NO, positive-logic may cause serious accidents.
-

## [DESIGN PRECAUTIONS]

---

### CAUTION

---

- When an inductive load such as a lamp, heater, or solenoid valve is controlled, a large current (approximately ten times greater than normal) may flow when the output is turned from off to on. Take proper measures so that the flowing current does not exceed the value corresponding to the maximum load specification of the resistance load.
  - After the CPU module is powered on or is reset, the time taken to enter the RUN status varies depending on the system configuration, parameter settings, and/or program size. Design circuits so that the entire system will always operate safely, regardless of this variation in time.
  - Simultaneously turn on and off the power supplies of the CPU module and extension modules.
  - If a long-time power failure or an abnormal voltage drop occurs, the PLC stops, and output is turned off. When the power supply is restored, it will automatically restart (when the RUN/STOP/RESET switch is on the RUN side).
- 

## [SECURITY PRECAUTIONS]

---

### WARNING

---

- To maintain the security (confidentiality, integrity, and availability) of the programmable controller and the system against unauthorized access, denial-of-service (DoS) attacks, computer viruses, and other cyberattacks from unreliable networks and devices via network, take appropriate measures such as firewalls, virtual private networks (VPNs), and antivirus solutions.
- 

## [INSTALLATION PRECAUTIONS]

---

### WARNING

---

- Make sure to cut off all phases of the power supply externally before attempting installation or wiring work. Failure to do so may cause electric shock or damage to the product.
  - Use the product within the generic environment specifications described in the MELSEC iQ-F FX5S/FX5UJ/FX5U/FX5UC User's Manual (Hardware).  
Never use the product in areas with excessive dust, oily smoke, conductive dusts, corrosive gas (salt air, Cl<sub>2</sub>, H<sub>2</sub>S, SO<sub>2</sub> or NO<sub>2</sub>), flammable gas, vibration or impacts, or expose it to high temperature, condensation, or rain and wind.  
If the product is used in such conditions, electric shock, fire, malfunctions, deterioration or damage may occur.
-

## [INSTALLATION PRECAUTIONS]

---

### CAUTION

---

- Do not touch the conductive parts of the product directly. Doing so may cause device failures or malfunctions.
  - When drilling screw holes or wiring, make sure that cutting and wiring debris do not enter the ventilation slits of the PLC. Failure to do so may cause fire, equipment failures or malfunctions.
  - For the product supplied together with a dust proof sheet, the sheet should be affixed to the ventilation slits before the installation and wiring work to prevent foreign objects such as cutting and wiring debris.  
However, when the installation work is completed, make sure to remove the sheet to provide adequate ventilation. Failure to do so may cause fire, equipment failures or malfunctions.
  - Install the product on a flat surface. If the mounting surface is rough, excessive force will be applied to the PC board, thereby causing malfunction.
  - Install the product securely using a DIN rail or mounting screws.
  - Connect the expansion board and expansion adapter securely to their designated connectors. Loose connections may cause malfunctions.
  - Make sure to affix the expansion board with tapping screws. Tightening torque should follow the specifications in the MELSEC iQ-F FX5S/FX5UJ/FX5U/FX5UC User's Manual (Hardware). If the screws are tightened outside of the specified torque range, poor connections may cause malfunctions.
  - Work carefully when using a screwdriver such as installation of the product. Failure to do so may cause damage to the product or accidents.
  - Connect the extension cables, peripheral device cables, input/output cables and battery connecting cable securely to their designated connectors. Loose connections may cause malfunctions.
  - When using an SD memory card, insert it into the SD memory card slot. Check that it is inserted completely. Poor contact may cause malfunction.
  - Turn off the power to the PLC before attaching or detaching the following devices. Failure to do so may cause device failures or malfunctions.
    - Peripheral devices, expansion board, expansion adapter, and connector conversion adapter
    - Extension modules, bus conversion module, and connector conversion module
    - Battery
-

## [WIRING PRECAUTIONS]

---

### **WARNING**

- Make sure to cut off all phases of the power supply externally before attempting installation or wiring work. Failure to do so may cause electric shock or damage to the product.
  - Make sure to attach the terminal cover, provided as an accessory, before turning on the power or initiating operation after installation or wiring work. Failure to do so may cause electric shock.
  - The temperature rating of the cable should be 80°C or more.
  - Make sure to wire the screw terminal block in accordance with the following precautions. Failure to do so may cause electric shock, equipment failures, a short-circuit, wire breakage, malfunctions, or damage to the product.
    - The disposal size of the cable end should follow the dimensions described in the MELSEC iQ-F FX5S/FX5UJ/FX5U/FX5UC User's Manual (Hardware).
    - Tightening torque should follow the specifications in the MELSEC iQ-F FX5S/FX5UJ/FX5U/FX5UC User's Manual (Hardware).
    - Tighten the screws using a Phillips-head screwdriver No.2 (shaft diameter 6 mm or less). Make sure that the screwdriver does not touch the partition part of the terminal block.
  - Make sure to properly wire to the terminal block (European type) in accordance with the following precautions. Failure to do so may cause electric shock, equipment failures, a short-circuit, wire breakage, malfunctions, or damage to the product.
    - The disposal size of the cable end should follow the dimensions described in the MELSEC iQ-F FX5S/FX5UJ/FX5U/FX5UC User's Manual (Hardware).
    - Tightening torque should follow the specifications in the MELSEC iQ-F FX5S/FX5UJ/FX5U/FX5UC User's Manual (Hardware).
    - Twist the ends of stranded wires and make sure that there are no loose wires.
    - Do not solder-plate the electric wire ends.
    - Do not connect more than the specified number of wires or electric wires of unspecified size.
    - Fix the electric wires so that neither the terminal block nor the connected parts are directly stressed.
  - Make sure to properly wire to the spring clamp terminal block in accordance with the following precautions.

Failure to do so may cause electric shock, equipment failures, a short-circuit, wire breakage, malfunctions, or damage to the product.

    - The disposal size of the cable end should follow the dimensions described in the MELSEC iQ-F FX5S/FX5UJ/FX5U/FX5UC User's Manual (Hardware).
    - Twist the ends of stranded wires and make sure that there are no loose wires.
    - Do not solder-plate the electric wire ends.
    - Do not connect more than the specified number of wires or electric wires of unspecified size.
    - Fix the electric wires so that neither the terminal block nor the connected parts are directly stressed.
-

## [WIRING PRECAUTIONS]

---

### CAUTION

- Do not supply power externally to the [24+] and [24V] terminals (24VDC service power supply) on the CPU module or extension modules. Doing so may cause damage to the product. Note that power may be supplied even when an electronic load which equips with an internal bias power supply is connected.
  - Perform class D grounding (grounding resistance: 100Ω or less) to the grounding terminal on the CPU module and extension modules with a wire 2 mm<sup>2</sup> or thicker.  
Do not use common grounding with heavy electrical systems (refer to the MELSEC iQ-F FX5S/FX5UJ/FX5U/FX5UC User's Manual (Hardware)).
  - Connect the power supply to the dedicated terminals specified in the MELSEC iQ-F FX5S/FX5UJ/FX5U/FX5UC User's Manual (Hardware). If an AC power supply is connected to a DC input/output terminal or DC power supply terminal, the PLC will burn out.
  - Do not wire vacant terminals externally. Doing so may damage the product.
  - Install module so that excessive force will not be applied to terminal blocks, power connectors, I/O connectors, communication connectors, or communication cables. Failure to do so may result in wire damage/breakage or PLC failure.
  - Make sure to observe the following precautions in order to prevent any damage to the machinery or accidents due to malfunction of the PLC caused by abnormal data written to the PLC due to the effects of noise:
    - Do not bundle the power line, control line, input/output cables and communication cables together with or lay them close to the main circuit, high-voltage line, load line or power line. As a guideline, lay the power line, control line and connection cables at least 100 mm away from the main circuit, high-voltage line, load line or power line.
    - Ground the shield of the shield wire or shielded cable at one point on the PLC. However, do not use common grounding with heavy electrical systems.
    - Ground the shield of the analog input/output cable in accordance with the manuals of each model. However, do not use common grounding with heavy electrical systems.
-

## [STARTUP AND MAINTENANCE PRECAUTIONS]

---

### **WARNING**

- Do not touch any terminal while the PLC's power is on. Doing so may cause electric shock or malfunctions.
  - Before cleaning or retightening terminals, cut off all phases of the power supply externally. Failure to do so may cause electric shock.
  - Before modifying the program in operation, forcible output, running or stopping the PLC, read through this manual carefully, and ensure complete safety. An operation error may damage the machinery or cause accidents.
  - Do not change the program in the PLC from two or more peripheral equipment devices at the same time. (i.e. from an engineering tool and a GOT) Doing so may cause destruction or malfunction of the PLC program.
  - Use the battery for memory backup in conformance to the MELSEC iQ-F FX5S/FX5UJ/FX5U/FX5UC User's Manual (Hardware).
    - Use the battery for the specified purpose only.
    - Connect the battery correctly.
    - Do not charge, disassemble, heat, put in fire, short-circuit, connect reversely, weld, swallow or burn the battery, or apply excessive forces (vibration, impact, drop, etc.) to the battery.
    - Do not store or use the battery at high temperatures or expose to direct sunlight.
    - Do not expose to water, bring near fire or touch liquid leakage or other contents directly.Incorrect handling of the battery may cause heat excessive generation, bursting, ignition, liquid leakage or deformation, and lead to injury, fire or failures and malfunction of facilities and other equipment.
- 

## [STARTUP AND MAINTENANCE PRECAUTIONS]

---

### **CAUTION**

- Do not disassemble or modify the PLC. Doing so may cause fire, equipment failures, or malfunctions. For repair, contact your local Mitsubishi Electric representative.
  - Turn off the power to the PLC before connecting or disconnecting any extension cable. Failure to do so may cause equipment failures or malfunctions.
  - Turn off the power to the PLC before attaching or detaching the following devices. Failure to do so may cause equipment failures or malfunctions.
    - Peripheral devices, expansion board, expansion adapter, and connector conversion adapter
    - Extension modules, bus conversion module, and connector conversion module
    - Battery
  - Since there are risks such as burn injuries, please do not touch the surface of the equipment with bare hands when it is operating in an environment which exceeds ambient temperature of 50°C.
- 

## [OPERATION PRECAUTIONS]

---

### **CAUTION**

- Construct an interlock circuit in the program so that the whole system always operates on the safe side before executing the control (for data change) of the PLC in operation. Read the manual thoroughly and ensure complete safety before executing other controls (for program change, parameter change, forcible output and operation status change) to the PLC in operation. Otherwise, the machine may be damaged and accidents may occur by erroneous operations.
-



## [DISPOSAL PRECAUTIONS]

---

### CAUTION

- Please contact a certified electronic waste disposal company for the environmentally safe recycling and disposal of your device.
  - When disposing of batteries, separate them from other waste according to local regulations. (For details of the Battery Directive in EU countries, refer to the MELSEC iQ-F FX5S/FX5UJ/FX5U/FX5UC User's Manual (Hardware).)
- 

## [TRANSPORTATION PRECAUTIONS]

---

### CAUTION

- When transporting the PLC with the optional battery, turn on the PLC before shipment, confirm that the battery mode is set using a parameter and the BAT LED is OFF, and check the battery life. If the PLC is transported with the BAT LED ON or the battery exhausted, the battery-backed data may be unstable during transportation.
  - The PLC is a precision instrument. During transportation, avoid impacts larger than those specified in the general specifications of the MELSEC iQ-F FX5S/FX5UJ/FX5U/FX5UC User's Manual (Hardware) by using dedicated packaging boxes and shock-absorbing palettes. Failure to do so may cause failures in the PLC. After transportation, verify operation of the PLC and check for damage of the mounting part, etc.
  - When transporting lithium batteries, follow required transportation regulations. (For details on the regulated products, refer to the MELSEC iQ-F FX5S/FX5UJ/FX5U/FX5UC User's Manual (Hardware).)
  - When fumigants that contain halogen materials such as fluorine, chlorine, bromine, and iodine are used for disinfecting and protecting wooden packaging from insects, they cause malfunction when entering our products. Please take necessary precautions to ensure that remaining materials from fumigant do not enter our products, or treat packaging with methods other than fumigation (heat method). Additionally, disinfect and protect wood from insects before packing products.
-

# INTRODUCTION

This manual contains text, diagrams and explanations which will guide the reader in the correct installation, safe use and operation of the FX5 Programmable Controllers and should be read and understood before attempting to install or use the module.

Always forward it to the end user.

## Target modules

Item	Model
FX5S CPU module	FX5S-30MR/ES, FX5S-30MT/ES, FX5S-30MT/ESS, FX5S-40MR/ES, FX5S-40MT/ES, FX5S-40MT/ESS, FX5S-60MR/ES, FX5S-60MT/ES, FX5S-60MT/ESS, FX5S-80MR/ES <sup>*1</sup> , FX5S-80MT/ES <sup>*1</sup> , FX5S-80MT/ESS <sup>*1</sup>
FX5UJ CPU module	FX5UJ-24MR/ES, FX5UJ-24MT/ES, FX5UJ-24MT/ESS, FX5UJ-40MR/ES, FX5UJ-40MT/ES, FX5UJ-40MT/ESS, FX5UJ-60MR/ES, FX5UJ-60MT/ES, FX5UJ-60MT/ESS, FX5UJ-24MR/DS, FX5UJ-24MT/DS, FX5UJ-24MT/DSS, FX5UJ-40MR/DS, FX5UJ-40MT/DS, FX5UJ-40MT/DSS, FX5UJ-60MR/DS, FX5UJ-60MT/DS, FX5UJ-60MT/DSS
FX5U CPU module	FX5U-32MR/ES, FX5U-32MT/ES, FX5U-32MT/ESS, FX5U-64MR/ES, FX5U-64MT/ES, FX5U-64MT/ESS, FX5U-80MR/ES, FX5U-80MT/ES, FX5U-80MT/ESS, FX5U-32MR/DS, FX5U-32MT/DS, FX5U-32MT/DSS, FX5U-64MR/DS, FX5U-64MT/DS, FX5U-64MT/DSS, FX5U-80MR/DS, FX5U-80MT/DS, FX5U-80MT/DSS
FX5UC CPU module	FX5UC-32MT/D, FX5UC-32MT/DSS, FX5UC-32MT/DS-TS, FX5UC-32MT/DSS-TS, FX5UC-32MR/DS-TS, FX5UC-64MT/D, FX5UC-64MT/DSS, FX5UC-96MT/D, FX5UC-96MT/DSS
High-speed pulse input/output module	FX5-16ET/ES-H, FX5-16ET/ESS-H
Analog adapter	FX5-4A-ADP, FX5-4AD-ADP, FX5-4DA-ADP, FX5-4AD-PT-ADP, FX5-4AD-TC-ADP

\*1 Area-specific model

## Regarding use of this product

- This product has been manufactured as a general-purpose part for general industries, and has not been designed or manufactured to be incorporated in a device or system used in purposes related to human life.
- Before using the product for special purposes such as nuclear power, electric power, aerospace, medicine or passenger movement vehicles, consult Mitsubishi Electric.
- This product has been manufactured under strict quality control. However when installing the product where major accidents or losses could occur if the product fails, install appropriate backup or failsafe functions in the system.

## Note

- If in doubt at any stage during the installation of the product, always consult a professional electrical engineer who is qualified and trained in the local and national standards. If in doubt about the operation or use, please consult the nearest Mitsubishi Electric representative.
- Since the examples indicated by this manual, technical bulletin, catalog, etc. are used as a reference, please use it after confirming the function and safety of the equipment and system. Mitsubishi Electric will accept no responsibility for actual use of the product based on these illustrative examples.
- This manual content, specification etc. may be changed without a notice for improvement.
- The information in this manual has been carefully checked and is believed to be accurate; however, if you notice a doubtful point, an error, etc., please contact the nearest Mitsubishi Electric representative. When doing so, please provide the manual number given at the end of this manual.

# CONTENTS

SAFETY PRECAUTIONS .....	1
INTRODUCTION .....	8
RELEVANT MANUALS .....	23
TERMS .....	23
GENERIC TERMS AND ABBREVIATIONS .....	24

## PART 1 PROGRAMMING

<b>CHAPTER 1 PROGRAM EXECUTION</b> .....	<b>26</b>
<b>1.1 Scan Configuration</b> .....	<b>26</b>
Initial processing and initialization processing in RUN mode .....	26
I/O refresh .....	27
Program operations .....	27
END processing .....	27
<b>1.2 Scan Time</b> .....	<b>27</b>
Initial scan time .....	28
<b>1.3 Program Execution Sequence</b> .....	<b>28</b>
<b>1.4 Execution Type of Program</b> .....	<b>29</b>
Initial execution type program .....	29
Scan execution type program .....	30
Fixed scan execution type program .....	30
Event execution type program .....	34
Stand-by type program .....	37
<b>1.5 Program Type</b> .....	<b>38</b>
Subroutine program .....	38
Interrupt program .....	39
<b>CHAPTER 2 PROCESSING OF OPERATIONS ACCORDING TO CPU MODULE OPERATION STATUS</b> .....	<b>44</b>
<b>CHAPTER 3 CPU MODULE MEMORY CONFIGURATION</b> .....	<b>46</b>
<b>3.1 Memory Configuration</b> .....	<b>46</b>
Memory configuration .....	46
<b>3.2 Program Capacity Setting</b> .....	<b>49</b>
<b>3.3 Files</b> .....	<b>50</b>
File type and storage destination memory .....	50
Executable file operations .....	51
<b>3.4 Memory Operation</b> .....	<b>52</b>
Initialization and value clear .....	52
<b>CHAPTER 4 DEVICES</b> .....	<b>53</b>
<b>4.1 List of Devices</b> .....	<b>53</b>
<b>4.2 User Devices</b> .....	<b>54</b>
Input (X) .....	54
Output (Y) .....	54
Internal relay (M) .....	55
Latch relay (L) .....	55

Link relay (B) . . . . .	55
Annunciator (F) . . . . .	55
Link special relay (SB) . . . . .	57
Step relay (S) . . . . .	57
Timer (T/ST) . . . . .	57
Counter (C/LC) . . . . .	60
Data register (D) . . . . .	62
Link register (W) . . . . .	62
Link special register (SW) . . . . .	62
<b>4.3 System Devices . . . . .</b>	<b>62</b>
Special relay (SM) . . . . .	62
Special register (SD) . . . . .	63
<b>4.4 Module Access Device . . . . .</b>	<b>63</b>
Specification method . . . . .	63
Processing speed . . . . .	63
<b>4.5 Index Register (Z/LZ) . . . . .</b>	<b>64</b>
Types of index registers . . . . .	64
Device for which index modification can be performed . . . . .	64
Index register setting . . . . .	65
<b>4.6 File Register (R/ER) . . . . .</b>	<b>65</b>
Types of file register . . . . .	65
Extended file register (ER) function . . . . .	66
<b>4.7 Nesting (N) . . . . .</b>	<b>70</b>
<b>4.8 Pointer (P) . . . . .</b>	<b>70</b>
Global pointers . . . . .	71
Label assignment pointers . . . . .	71
<b>4.9 Interrupt Pointer (I) . . . . .</b>	<b>71</b>
Interrupt causes of the interrupt pointer numbers . . . . .	72
The priority for the interrupt pointer numbers and interrupt factors . . . . .	72
<b>4.10 SFC Devices . . . . .</b>	<b>73</b>
SFC block device (BL) . . . . .	73
SFC transition device (TR) . . . . .	73
<b>4.11 Indirect Specification . . . . .</b>	<b>73</b>
<b>4.12 Constant . . . . .</b>	<b>74</b>
Decimal constant (K) . . . . .	74
Hexadecimal constant (H) . . . . .	74
Real constant (E) . . . . .	74
Character string constant . . . . .	75
<b>4.13 Initial Device Value Setting . . . . .</b>	<b>75</b>
Setting initial device values . . . . .	76
<b>4.14 Applicable Devices . . . . .</b>	<b>76</b>

---

**CHAPTER 5 LABELS** **77**

---

**CHAPTER 6 CAPACITY SETTING OF EACH AREA IN DEVICE/LABEL MEMORY** **79**

<b>6.1 Default Capacity of Each Area . . . . .</b>	<b>79</b>
<b>6.2 The Setting Range of the Capacity of Each Area . . . . .</b>	<b>79</b>
<b>6.3 Device/Label Memory Area Setting . . . . .</b>	<b>80</b>
<b>6.4 Device Setting . . . . .</b>	<b>81</b>
Range of use of device points . . . . .	82

<b>CHAPTER 7</b>	<b>DEVICE/LABEL ACCESS SERVICE PROCESSING SETTING</b>	<b>83</b>
------------------	---	-----------

## **PART 2 CPU MODULE BUILT-IN FUNCTIONS**

<b>CHAPTER 8</b>	<b>FUNCTION LIST</b>	<b>87</b>
------------------	----------------------	-----------

<b>CHAPTER 9</b>	<b>FIRMWARE UPDATE FUNCTION</b>	<b>89</b>
------------------	---------------------------------	-----------

<b>9.1</b>	<b>Update Using an SD Memory Card</b> . . . . .	<b>89</b>
	CPU module firmware update . . . . .	90
<b>9.2</b>	<b>Update Using the Engineering Tool</b> . . . . .	<b>95</b>
	CPU module firmware update . . . . .	95
	Updating the firmware for the intelligent function module . . . . .	100

<b>CHAPTER 10</b>	<b>ONLINE CHANGE</b>	<b>106</b>
-------------------	----------------------	------------

<b>10.1</b>	<b>Online Ladder Block Change</b> . . . . .	<b>106</b>
	Editable contents . . . . .	106
	Range changeable in a single session . . . . .	106
	Online ladder block change during the boot operation . . . . .	106
	Precautions . . . . .	106

<b>CHAPTER 11</b>	<b>INTERRUPT FUNCTION</b>	<b>109</b>
-------------------	---------------------------	------------

<b>11.1</b>	<b>Multiple Interrupt Function</b> . . . . .	<b>109</b>
	Interrupt priority . . . . .	109
<b>11.2</b>	<b>Input Interrupt Delay Function</b> . . . . .	<b>111</b>
	Delay time setting . . . . .	111
	Delay execution of the interrupt program . . . . .	112

<b>CHAPTER 12</b>	<b>SCAN MONITORING FUNCTION</b>	<b>114</b>
-------------------	---------------------------------	------------

<b>12.1</b>	<b>Scan Time Monitoring Time Setting</b> . . . . .	<b>114</b>
<b>12.2</b>	<b>Resetting of the Watchdog Timer</b> . . . . .	<b>114</b>
<b>12.3</b>	<b>Precautions</b> . . . . .	<b>115</b>
	Watchdog timer reset when executing a program repeatedly . . . . .	115
	Scan time when the WDT instruction is used . . . . .	115

<b>CHAPTER 13</b>	<b>CONSTANT SCAN</b>	<b>116</b>
-------------------	----------------------	------------

<b>13.1</b>	<b>Constant Scan Settings</b> . . . . .	<b>116</b>
-------------	---	------------

<b>CHAPTER 14</b>	<b>REMOTE OPERATION</b>	<b>118</b>
-------------------	-------------------------	------------

<b>14.1</b>	<b>Remote RUN/STOP</b> . . . . .	<b>118</b>
	Applications of remote RUN/STOP . . . . .	118
	Operation during remote RUN/STOP . . . . .	118
	Method of execution of remote RUN/STOP . . . . .	118
<b>14.2</b>	<b>Remote PAUSE</b> . . . . .	<b>120</b>
	Application of remote PAUSE . . . . .	120
	Method of execution of remote PAUSE . . . . .	120
<b>14.3</b>	<b>Remote RESET</b> . . . . .	<b>121</b>
	Application of remote RESET . . . . .	121
	Enabling remote RESET . . . . .	121
	Method of execution of remote RESET . . . . .	121

14.4	Relationship Between Remote Operation and CPU Module .....	122
<b>CHAPTER 15 LATCH FUNCTION</b>		<b>123</b>
15.1	Types of Latch .....	123
15.2	Device/label that can be Latched .....	123
15.3	Latch Settings .....	124
	Latch settings .....	124
15.4	Clearing of Data of the Latch Range .....	126
15.5	Precautions .....	126
<b>CHAPTER 16 RAS FUNCTIONS</b>		<b>127</b>
16.1	Self-Diagnostics Function .....	127
	Self-diagnostics timing .....	127
	Check method of error .....	127
	CPU module operation upon error detection setting .....	128
	Error clear .....	129
16.2	Event History Function .....	130
	Event history settings .....	131
	Logging of the event history .....	131
	Viewing the event history .....	134
	Clearing the event history .....	134
	Precautions .....	134
<b>CHAPTER 17 EXTERNAL INPUT/OUTPUT FORCED ON/OFF FUNCTION</b>		<b>135</b>
<b>CHAPTER 18 CLOCK FUNCTION</b>		<b>141</b>
18.1	Time Setting .....	141
	Clock data .....	141
	Changing the clock data .....	141
	Reading clock data .....	142
	Precautions .....	142
18.2	Setting Time Zone .....	143
18.3	System Clock .....	144
	Special relay used for system clock .....	144
	Special register used for system clock .....	144
<b>CHAPTER 19 SECURITY FUNCTIONS</b>		<b>145</b>
<b>CHAPTER 20 DATA LOGGING FUNCTION</b>		<b>147</b>
20.1	Application Example .....	148
20.2	Specifications List .....	149
20.3	Procedure for Using .....	150
	Devices and software to be used .....	150
	Usage flow .....	150
	Setting example .....	151
	Programs example .....	153
	Operating procedure .....	153
20.4	Data Logging Execution by Special Relay .....	162
20.5	Details of Specifications .....	163
	Logging type .....	163

Data collection conditions . . . . .	165
Target data . . . . .	167
Trigger condition . . . . .	168
Data logging file . . . . .	169
Saving and file switching . . . . .	175
Data logging file transfer function (FTP server auto transfer) . . . . .	181
Setting the operation at the time of transition to RUN . . . . .	188
<b>20.6 Precautions . . . . .</b>	<b>189</b>
<b>20.7 SD Memory Card Life and Replacement . . . . .</b>	<b>194</b>
SD memory card life . . . . .	194
SD memory card replacement . . . . .	195
<b>CHAPTER 21 MEMORY DUMP FUNCTION . . . . .</b>	<b>197</b>
<hr/>	
<b>21.1 Object Data . . . . .</b>	<b>198</b>
Data to be collected . . . . .	198
<b>21.2 Trigger Condition . . . . .</b>	<b>198</b>
Device specification . . . . .	199
At the occurrence of an error . . . . .	199
Combining trigger conditions . . . . .	200
<b>21.3 Procedure for Memory Dump . . . . .</b>	<b>201</b>
<b>21.4 Flow of Data Collection . . . . .</b>	<b>201</b>
Effect on the scan time . . . . .	201
<b>21.5 Memory Dump File . . . . .</b>	<b>202</b>
Save file name . . . . .	202
<b>21.6 States of the Memory Dump Function . . . . .</b>	<b>202</b>
Memory dump status . . . . .	202
<b>21.7 Sizes of Files Used for the Memory Dump Function . . . . .</b>	<b>203</b>
Capacity of the memory dump setting file . . . . .	203
Capacity of the memory dump file . . . . .	203
<b>21.8 Special Relay and Special Register Used in the Memory Dump Function . . . . .</b>	<b>204</b>
<b>21.9 Precautions for the Memory Dump Function . . . . .</b>	<b>204</b>
<b>CHAPTER 22 INTERNAL BUFFER CAPACITY SETTING . . . . .</b>	<b>206</b>
<hr/>	
<b>CHAPTER 23 DATA BACKUP/RESTORATION FUNCTION . . . . .</b>	<b>208</b>
<hr/>	
<b>23.1 Backup Function . . . . .</b>	<b>212</b>
Backup processing triggered by turning on SM1351 (Normal mode) . . . . .	213
Backup processing triggered by turning on SM1351 (CPU module auto exchange function) . . . . .	214
Checking backup errors . . . . .	215
Precautions . . . . .	215
<b>23.2 Restoration Function . . . . .</b>	<b>217</b>
Restoration processing triggered by turning on SM1354 . . . . .	219
Automatic restoration using SD955 . . . . .	220
Restoration triggered by CPU module auto exchange . . . . .	221
Checking restoration errors . . . . .	221
Precautions . . . . .	222
<b>CHAPTER 24 REAL-TIME MONITOR FUNCTION . . . . .</b>	<b>226</b>
<hr/>	
<b>CHAPTER 25 MEMORY CARD FUNCTION . . . . .</b>	<b>228</b>
<hr/>	

25.1	SD Memory Card Forced Stop	228
25.2	Boot Operation	230

## **CHAPTER 26 HIGH-SPEED INPUT/OUTPUT FUNCTION** **232**

<b>26.1</b>	<b>High-speed Counter Function</b>	<b>232</b>
	High-speed counter function overview	232
	High-speed counter function execution procedure	234
	High-speed counter specifications	234
	Assignment for high-speed counters	238
	High-speed counter parameters	245
	High-speed counter (normal mode)	246
	High-speed counter (pulse density measurement mode)	249
	High-speed counter (rotational speed measurement mode)	251
	High-speed comparison table	254
	Multiple point output, high-speed comparison tables	257
	High-speed comparison match starts	260
	Special relay details	262
	Special register details	271
	Special relays/special registers capable of high-speed transfers with the HCMOV/DHCMOV instruction	280
	Precautions when using high-speed counters	283
<b>26.2</b>	<b>FX3-compatible High-speed Counter Function</b>	<b>288</b>
	FX3-compatible high-speed counter function overview	288
	How to start/stop the high-speed counter using the LC device	288
	The elements of the composition of the LC device	289
	The comparison between the UDCNTF instruction and HIOEN/DHIOEN instruction	289
	Assignment for FX3-compatible high-speed counters	291
	FX3-compatible high-speed counter setting	293
	FX3-compatible high-speed counter	293
	Special relays/LC devices capable of high-speed transfers with the HCMOV/DHCMOV instruction	295
	Precautions when using FX3-compatible high-speed counters	296
<b>26.3</b>	<b>Pulse Width Measurement Function</b>	<b>297</b>
	Pulse width measurement function overview	297
	Pulse width measurement specifications	297
	Pulse measurement function execution procedure	300
	Pulse width measurement parameters	300
	Details of special relays/special registers	301
	Cautions when using the pulse width measurement function	306
	Examples of program	306
<b>26.4</b>	<b>Pulse Catch Function</b>	<b>308</b>
	Outline of pulse catch function	308
	Specifications of pulse catch function	308
	Pulse catch function execution procedure	309
	Pulse catch parameters	309
	Operation of pulse catch function	311
	Cautions when using the pulse catch function	312
<b>26.5</b>	<b>FX3-compatible Pulse Catch Function</b>	<b>313</b>
	Outline of FX3-compatible pulse catch function	313
	Specifications of FX3-compatible pulse catch function	313
	FX3-compatible pulse catch function execution procedure	314
	FX3-compatible pulse catch parameters	314



	Operation of FX3-compatible pulse catch function . . . . .	315
	Cautions when using the FX3-compatible pulse catch function . . . . .	315
<b>26.6</b>	<b>General-purpose Input Functions . . . . .</b>	<b>316</b>
	Outline of general-purpose input functions . . . . .	316
	Specifications of general-purpose inputs . . . . .	316
	General-purpose input function parameters . . . . .	318
<b>26.7</b>	<b>PWM Function . . . . .</b>	<b>319</b>
	Outline of PWM output . . . . .	319
	PWM output specifications . . . . .	319
	PWM output function execution procedure . . . . .	322
	PWM output parameters . . . . .	322
	Details of special relays/special registers . . . . .	325
	Cautions when using the PWM function . . . . .	328
	Examples of program . . . . .	329

## PART 3 POSITIONING FUNCTIONS

<b>CHAPTER 27</b>	<b>OUTLINE . . . . .</b>	<b>332</b>
<b>27.1</b>	<b>Features . . . . .</b>	<b>332</b>
<b>27.2</b>	<b>Setup Procedure for Positioning Control . . . . .</b>	<b>333</b>
<b>CHAPTER 28</b>	<b>FUNCTION LIST . . . . .</b>	<b>334</b>
<b>CHAPTER 29</b>	<b>SPECIFICATIONS . . . . .</b>	<b>336</b>
<b>29.1</b>	<b>Performance Specifications . . . . .</b>	<b>336</b>
<b>29.2</b>	<b>Input Specifications . . . . .</b>	<b>338</b>
	Input assignment . . . . .	341
<b>29.3</b>	<b>Output Specifications . . . . .</b>	<b>343</b>
	Assignment of output numbers . . . . .	346
<b>CHAPTER 30</b>	<b>POSITIONING CONTROL FUNCTION . . . . .</b>	<b>348</b>
<b>30.1</b>	<b>List of Control Functions . . . . .</b>	<b>348</b>
<b>30.2</b>	<b>OPR Control . . . . .</b>	<b>349</b>
	Mechanical OPR . . . . .	349
	High-speed OPR . . . . .	349
<b>30.3</b>	<b>Positioning Control . . . . .</b>	<b>350</b>
	1-speed positioning . . . . .	350
	2-speed positioning . . . . .	350
	Multi-speed operation . . . . .	351
	Interrupt stop . . . . .	351
	Interrupt 1-speed positioning . . . . .	352
	Interrupt 2-speed positioning . . . . .	353
	Variable speed operation . . . . .	354
	Table operation . . . . .	354
	Simple linear interpolation operation (2-axis simultaneous start) . . . . .	355
<b>30.4</b>	<b>Auxiliary Function . . . . .</b>	<b>356</b>
	Dog search function . . . . .	356
	Dwell time . . . . .	358
	OPR zero signal count . . . . .	358
	Forward limit and reverse limit . . . . .	359

Positioning address change during positioning operation . . . . .	359
Command speed change during positioning operation . . . . .	360
Pulse decelerate and stop . . . . .	361
Remaining distance operation . . . . .	362
Multiple axes simultaneous activation . . . . .	363
Detection of absolute position . . . . .	363
All module reset when a stop error occurs . . . . .	363

---

## **CHAPTER 31 POSITIONING PARAMETER 364**

<b>31.1 Setting Method. . . . .</b>	<b>364</b>
Basic setting . . . . .	365
Input check . . . . .	368
Output check . . . . .	369
<b>31.2 Details of Parameters . . . . .</b>	<b>370</b>
Common item . . . . .	370
Items related to speed . . . . .	375
Items related to positioning address . . . . .	378
Items related to operating command . . . . .	381
Items related to pulse Y output instruction . . . . .	386
Items related to OPR . . . . .	387
Items related to table operation . . . . .	393
Items related to monitor . . . . .	398

---

## **CHAPTER 32 POSITIONING INSTRUCTION 402**

<b>32.1 Common Items. . . . .</b>	<b>402</b>
Operand specification method . . . . .	402
Start speed . . . . .	402
Pulse output stop . . . . .	404
Operation at an error or abnormal end . . . . .	405
Caution . . . . .	405
<b>32.2 Pulse Y Output . . . . .</b>	<b>405</b>
Related devices . . . . .	408
Outline of operation . . . . .	409
Program example . . . . .	411
<b>32.3 Mechanical OPR . . . . .</b>	<b>411</b>
Related devices . . . . .	413
Outline of operation . . . . .	416
Program example . . . . .	419
Caution . . . . .	420
<b>32.4 Relative Positioning . . . . .</b>	<b>421</b>
Related devices . . . . .	424
Outline of operation . . . . .	426
Program example . . . . .	429
<b>32.5 Absolute Positioning. . . . .</b>	<b>431</b>
Related devices . . . . .	434
Outline of operation . . . . .	436
Program example . . . . .	438
<b>32.6 Interrupt 1-Speed Positioning . . . . .</b>	<b>440</b>
Related devices . . . . .	442
Outline of operation . . . . .	444

Program example	447
Caution	449
<b>32.7 Variable Speed Operation</b>	<b>450</b>
Related devices	452
Outline of operation	454
Program example	457
Caution	458
<b>32.8 Single-table Operation</b>	<b>459</b>
Related devices	460
Outline of operation	461
Program example	462
<b>32.9 Multiple-table Operation</b>	<b>468</b>
Related devices	469
Outline of operation	470
Program example	471
<b>32.10 Multiple-axis Table Operation</b>	<b>476</b>
Related devices	477
Outline of operation	478
Program example	480
<b>32.11 Absolute Position Detection System</b>	<b>483</b>
Related devices	483
Outline of operation	484
Program example	485
Caution	486

## **CHAPTER 33 TABLE OPERATION** **487**

<b>33.1 How to Use the Positioning Table</b>	<b>487</b>
Table setting method	487
<b>33.2 Operations of Control Method</b>	<b>490</b>
No Positioning	490
1 Speed Positioning (Relative Address Specification)	491
1 Speed Positioning (Absolute Address Specification)	493
Interrupt 1 Speed Positioning	495
Variable Speed Operation	498
Table Transition Variable Speed Operation	500
Interrupt Stop (Relative Address Specification)	502
Interrupt Stop (Absolute Address Specification)	505
Condition Jump	507
Interpolation Operation (Relative Address Specification)	509
Interpolation Operation (Relative Address Specification Target Axis)	513
Interpolation Operation (Absolute Address Specification)	514
Interpolation Operation (Absolute Address Specification Target Axis)	518
<b>33.3 How to Execute Multiple Tables</b>	<b>519</b>
Stepping operation	519
Continuous operation	521

## **CHAPTER 34 PROGRAMMING** **524**

<b>34.1 Table Operation Instruction</b>	<b>524</b>
<b>34.2 Cautions for Program Creation</b>	<b>524</b>
<b>34.3 Program Example</b>	<b>529</b>

Input/output assignment .....	531
Parameter setting .....	532
Forward/reverse rotation program .....	533
<b>34.4 FX3 Compatible SM/SD .....</b>	<b>536</b>

---

## **CHAPTER 35 TROUBLESHOOTING** **537**

<b>35.1 LED Status During Pulse Output and Rotation Direction Output .....</b>	<b>537</b>
<b>35.2 Servo Motor, Stepping Motor .....</b>	<b>538</b>
<b>35.3 Stop Position .....</b>	<b>539</b>

---

# **PART 4 ANALOG FUNCTIONS**

---

## **CHAPTER 36 CPU MODULE BUILT-IN ANALOG FUNCTION** **542**

<b>36.1 Specifications .....</b>	<b>542</b>
Generic specifications .....	542
Performance specifications .....	542
Accuracy .....	544
<b>36.2 List of Functions .....</b>	<b>545</b>
<b>36.3 Functions (Analog Input) .....</b>	<b>546</b>
Processing of each function .....	546
A/D conversion enable/disable setting function .....	547
A/D conversion method .....	548
Over scale detection function .....	550
Digital clipping function .....	551
Scaling function .....	552
Shift function .....	553
Maximum value/minimum value hold function .....	554
Warning output function .....	555
Event history function .....	556
<b>36.4 Functions (Analog Output) .....</b>	<b>557</b>
Processing of each function .....	557
D/A conversion enable/disable function .....	558
D/A output enable/disable setting function .....	558
Analog output HOLD/CLEAR function .....	559
Analog output test when CPU module is in STOP status function .....	560
Scaling function .....	561
Shift function .....	562
Warning output function .....	562
Event history function .....	564
<b>36.5 Function (PID Control Via Instruction) .....</b>	<b>564</b>
Outline of function .....	564
Basic operation expressions in PID instruction .....	565
How to use PID instruction .....	566
Relationship between parameter setting and auto-tuning .....	567
Parameter .....	568
Details of parameters .....	569
Auto-tuning .....	580
Examples of program .....	585
Example of parameter adjustment and the effect on PID control operation .....	596
<b>36.6 Function (PID Control Via Parameter) .....</b>	<b>601</b>

Outline of function . . . . .	601
Specifications list . . . . .	602
Usage procedure . . . . .	603
Heating-cooling PID setting parameter . . . . .	609
Details of specifications . . . . .	611
Setting and program examples . . . . .	628
Troubleshooting . . . . .	641
Precautions . . . . .	642
<b>36.7 Procedure to Execute the Built-in Analog Function . . . . .</b>	<b>643</b>
<b>36.8 Wiring . . . . .</b>	<b>643</b>
<b>36.9 Parameter Setting . . . . .</b>	<b>644</b>
Basic settings (analog input) . . . . .	644
Application settings (analog input) . . . . .	645
Basic settings (analog output) . . . . .	646
Application settings (analog input) . . . . .	647
<b>36.10 How to Use Analog Inputs Built in CPU Module for Current Inputs . . . . .</b>	<b>648</b>
<b>CHAPTER 37 ANALOG ADAPTERS . . . . .</b>	<b>649</b>
<hr/>	
<b>37.1 System Configuration . . . . .</b>	<b>650</b>
<b>37.2 Specifications . . . . .</b>	<b>650</b>
Generic specifications . . . . .	650
Power supply specifications . . . . .	650
Performance specifications . . . . .	651
Input conversion characteristics . . . . .	653
Output conversion characteristics . . . . .	655
Accuracy . . . . .	657
<b>37.3 Procedure to Operate the System . . . . .</b>	<b>659</b>
<b>37.4 Wiring . . . . .</b>	<b>659</b>
<b>37.5 List of Functions . . . . .</b>	<b>660</b>
<b>37.6 Functions (Analog Input) . . . . .</b>	<b>666</b>
A/D conversion enable/disable setting function . . . . .	666
Range switching function . . . . .	667
A/D conversion method . . . . .	669
Disconnection detection function . . . . .	672
Over scale detection function . . . . .	674
Digital clipping function . . . . .	676
Scaling function . . . . .	678
Warning output function . . . . .	682
Shift function . . . . .	689
Convergence detection function . . . . .	691
Maximum value/minimum value hold function . . . . .	693
Deviation detection between channel function . . . . .	694
Offset/gain setting function . . . . .	697
Offset/gain initialization function . . . . .	702
<b>37.7 Functions (Analog Output) . . . . .</b>	<b>703</b>
D/A conversion enable/disable function . . . . .	703
Range switching function . . . . .	704
Shift function . . . . .	705
Warning output function . . . . .	707
Scaling function . . . . .	709

Analog output HOLD/CLEAR function . . . . .	711
D/A output enable/disable setting function . . . . .	712
Disconnection detection function . . . . .	713
External power supply disconnection detection function . . . . .	716
Offset/gain setting function . . . . .	716
Offset/gain initialization function . . . . .	721
Analog output test when CPU module is in STOP status function . . . . .	722
<b>37.8 Functions (Temperature Sensor Input) . . . . .</b>	<b>724</b>
Conversion enable/disable setting function . . . . .	724
Temperature resistance choice function . . . . .	725
Thermocouple type choice function . . . . .	727
Disconnection detection function . . . . .	730
Temperature conversion method . . . . .	733
Temperature unit choice function . . . . .	736
Maximum value/minimum value hold function . . . . .	737
Warning output function . . . . .	739
Offset/gain setting function . . . . .	746
Offset/gain initialization function . . . . .	752
<b>37.9 Other Functions . . . . .</b>	<b>754</b>
Event history function . . . . .	754
Changing the setting value while the CPU module is operating . . . . .	754
Starting/stopping the analog function in accordance with the CPU module status . . . . .	755
Alarm clear request . . . . .	756
<b>37.10 Parameter Setting . . . . .</b>	<b>758</b>
Basic settings (analog input) . . . . .	758
Application settings (analog input) . . . . .	760
Basic settings (analog output) . . . . .	762
Application settings (analog output) . . . . .	763
Basic settings (temperature sensor input) . . . . .	764
Application settings (temperature sensor input) . . . . .	766
<b>37.11 Troubleshooting . . . . .</b>	<b>767</b>
Troubleshooting with the LEDs . . . . .	767
Checking the state of the module . . . . .	767
Troubleshooting by Symptom . . . . .	768
<b>APPENDIX . . . . .</b>	<b>772</b>
<hr/>	
<b>Appendix 1 Special Relay List . . . . .</b>	<b>772</b>
Diagnostic information . . . . .	772
System information . . . . .	773
SFC information . . . . .	773
System clock . . . . .	774
Scan information . . . . .	775
Drive information . . . . .	775
Instruction related . . . . .	776
Firmware update function . . . . .	776
Latch area . . . . .	776
Data logging function . . . . .	777
Data backup/restoration function . . . . .	778
File transfer function (FTP client) . . . . .	778
Memory dump function . . . . .	778

CC-Link IE Field Network Basic function . . . . .	778
High-speed input/output function . . . . .	779
CPU module built-in analog function . . . . .	784
Analog adapter . . . . .	785
FX compatible area . . . . .	792
Serial communication function . . . . .	797
Extended file register function . . . . .	798
<b>Appendix 2 Special Register List . . . . .</b>	<b>799</b>
Diagnostic information . . . . .	799
System information . . . . .	803
SFC information . . . . .	804
System clock . . . . .	804
Scan information . . . . .	805
Drive information . . . . .	806
Instruction related . . . . .	807
Latch area . . . . .	807
Data logging function . . . . .	808
Data backup/restoration function . . . . .	809
Mask pattern of interrupt pointers . . . . .	809
Memory dump function . . . . .	810
Real-time monitor function . . . . .	810
External input/output forced on/off function . . . . .	810
CC-Link IE Field Network Basic function . . . . .	810
FX dedicated . . . . .	814
High-speed input/output function . . . . .	815
CPU module built-in analog function . . . . .	823
Analog adapter . . . . .	824
FX compatible area . . . . .	834
Serial communication function . . . . .	836
Built-in Ethernet function . . . . .	840
<b>Appendix 3 Error Code . . . . .</b>	<b>849</b>
Error code system . . . . .	849
Operation when an error occurs . . . . .	850
Error check . . . . .	850
How to clear errors . . . . .	851
List of error codes . . . . .	851
<b>Appendix 4 Alarm Code . . . . .</b>	<b>894</b>
<b>Appendix 5 Parameter List . . . . .</b>	<b>897</b>
System parameters . . . . .	897
CPU parameters . . . . .	897
Module parameters . . . . .	898
Memory card parameters . . . . .	906
<b>Appendix 6 Event List . . . . .</b>	<b>907</b>
How to read the event list . . . . .	907
Event list . . . . .	908
<b>Appendix 7 Processing Time . . . . .</b>	<b>909</b>
SFC program processing time . . . . .	909
Processing time until the file operation is completed . . . . .	911
<b>Appendix 8 How to Use CPU Module Logging Configuration Tool . . . . .</b>	<b>913</b>
Screen configuration . . . . .	915
Menu structure . . . . .	916

Setting data logging .....	927
<b>Appendix 9 Connection Example of Servo Amplifier .....</b>	<b>939</b>
MELSERVO-J5, MELSERVO-J4, MELSERVO-J3 series .....	940
MELSERVO-JN series .....	954
<b>Appendix 10 Substitute Functions .....</b>	<b>964</b>
File registers .....	964
Replacing PLSR/DPLSR instruction to DRV/DDRVI instruction .....	965
Replacing ZRN/DZRN instruction to DSZR/DDSZR instruction .....	965
<b>Appendix 11 Added and Enhanced Functions .....</b>	<b>966</b>
<b>INDEX .....</b>	<b>972</b>
<hr/>	
REVISIONS .....	975
WARRANTY .....	977
TRADEMARKS .....	978



# RELEVANT MANUALS

Manual name <manual number>	Description
MELSEC iQ-F FX5S/FX5UJ/FX5U/FX5UC User's Manual (Hardware) <SH-082452ENG>	Describes the details of hardware of the CPU module, including performance specifications, wiring, installation, and maintenance.
MELSEC iQ-F FX5 User's Manual (Application) <JY997D55401> (This manual)	Describes the basic knowledge required for program design, functions of the CPU module, devices/labels, and parameters.
MELSEC iQ-F FX5 Programming Manual (Program Design) <JY997D55701>	Describes the specifications of ladder, ST, FBD/LD, and SFC programs, and labels.
MELSEC iQ-F FX5 Programming Manual (Instructions, Standard Functions/ Function Blocks) <JY997D55801>	Describes the specifications of instructions and functions that can be used in programs.
MELSEC iQ-F FX5 User's Manual (Communication) <SH-082625ENG>	Describes the communication function of the CPU module built-in and the Ethernet module.
GX Works3 Operating Manual <SH-081215ENG>	Describes the system configuration, parameter settings, and online operations of GX Works3.

# TERMS

Unless otherwise specified, this manual uses the following terms.

Term	Description
Engineering tool	The product name of the software package for the MELSEC programmable controllers

# GENERIC TERMS AND ABBREVIATIONS

Unless otherwise specified, this manual uses the following generic terms and abbreviations.

Generic term/abbreviation	Description
Analog adapter	Generic term for FX5-4AD-ADP, FX5-4DA-ADP, FX5-4AD-PT-ADP, FX5-4AD-TC-ADP, and FX5-4A-ADP
Battery	Generic term for FX3U-32BL
Bus conversion module	Generic term for Bus conversion module (extension cable type) and Bus conversion module (extension connector type)
Communication adapter	Generic term for FX5-232ADP and FX5-485ADP
Communication board	Generic term for FX5-232-BD, FX5-485-BD, and FX5-422-BD-GOT
Complete flag	Generic term for user-specified complete flags and FX3 compatible device flags that are turned on at normal/ abnormal completion of the positioning instruction
Expansion adapter	Generic term for adapter for FX5 CPU module
Expansion board	Generic term for board for FX5S CPU module, FX5UJ CPU module, and FX5U CPU module
Extension module	Generic term for FX5 extension modules, FX3 extension modules, Extension modules (extension cable type) and Extension modules (extension connector type)
Extension power supply module	Generic term for FX5 extension power supply module and FX3 extension power supply module
FX3	Generic term for FX3S, FX3G, FX3GC, FX3U, and FX3UC programmable controllers
FX5 CPU module	Generic term for FX5S CPU module, FX5UJ CPU module, FX5U CPU module, and FX5UC CPU module
FX5S CPU module	Generic term for FX5S-30MR/ES, FX5S-30MT/ES, FX5S-30MT/ESS, FX5S-40MR/ES, FX5S-40MT/ES, FX5S-40MT/ESS, FX5S-60MR/ES, FX5S-60MT/ES, FX5S-60MT/ESS, FX5S-80MR/ES <sup>*1</sup> , FX5S-80MT/ES <sup>*1</sup> , and FX5S-80MT/ESS <sup>*1</sup>
FX5U CPU module	Generic term for FX5U-32MR/ES, FX5U-32MT/ES, FX5U-32MT/ESS, FX5U-64MR/ES, FX5U-64MT/ES, FX5U-64MT/ESS, FX5U-80MR/ES, FX5U-80MT/ES, FX5U-80MT/ESS, FX5U-32MR/DS, FX5U-32MT/DS, FX5U-32MT/DSS, FX5U-64MR/DS, FX5U-64MT/DS, FX5U-64MT/DSS, FX5U-80MR/DS, FX5U-80MT/DS, and FX5U-80MT/DSS
FX5UC CPU module	Generic term for FX5UC-32MT/D, FX5UC-32MT/DSS, FX5UC-64MT/D, FX5UC-64MT/DSS, FX5UC-96MT/D, FX5UC-96MT/DSS, FX5UC-32MT/DS-TS, FX5UC-32MT/DSS-TS, and FX5UC-32MR/DS-TS
FX5UJ CPU module	Generic term for FX5UJ-24MR/ES, FX5UJ-24MT/ES, FX5UJ-24MT/ESS, FX5UJ-40MR/ES, FX5UJ-40MT/ES, FX5UJ-40MT/ESS, FX5UJ-60MR/ES, FX5UJ-60MT/ES, FX5UJ-60MT/ESS, FX5UJ-24MR/DS, FX5UJ-24MT/DS, FX5UJ-24MT/DSS, FX5UJ-40MR/DS, FX5UJ-40MT/DS, FX5UJ-40MT/DSS, FX5UJ-60MR/DS, FX5UJ-60MT/DS, and FX5UJ-60MT/DSS
GX Works3	The product name of the software package, SWnDND-GXW3, for the MELSEC programmable controllers (The 'n' represents a version.)
High-speed pulse input/output module	Generic term for FX5-16ET/ES-H and FX5-16ET/ESS-H
I/O module	Generic term for Input modules, Output modules, Input/output modules, Powered input/output modules, and High-speed pulse input/output modules
Input module	Generic term for Input modules (extension cable type) and Input modules (extension connector type)
Input/output module	Generic term for Input/output modules (extension cable type) and Input/output modules (extension connector type)
Intelligent function module	Generic term for FX5 intelligent function modules and FX3 intelligent function modules
Output module	Generic term for Output modules (extension cable type) and Output modules (extension connector type)
Peripheral device	Generic term for engineering tools and GOTs
SD memory card	Generic term for NZ1MEM-2GBSD, NZ1MEM-4GBSD, NZ1MEM-8GBSD, NZ1MEM-16GBSD, L1MEM-2GBSD, and L1MEM-4GBSD SD memory cards Abbreviation for Secure Digital Memory Card. Device that stores data using flash memory.
Table operation instruction	Generic term for the table operation (TBL) instruction, the multiple-table operation (DRV TBL) instruction, and the multiple-axis table operation (DRVMUL) instruction

\*1 These models are offered for specific regions.

This part consists of the following chapters.

1 PROGRAM EXECUTION

---

2 PROCESSING OF OPERATIONS ACCORDING TO CPU MODULE OPERATION STATUS

---

3 CPU MODULE MEMORY CONFIGURATION

---

4 DEVICES

---

5 LABELS

---

6 CAPACITY SETTING OF EACH AREA IN DEVICE/LABEL MEMORY

---

7 DEVICE/LABEL ACCESS SERVICE PROCESSING SETTING

---

# 1 PROGRAM EXECUTION

## 1.1 Scan Configuration

The configuration of the scan of the CPU module is explained below.

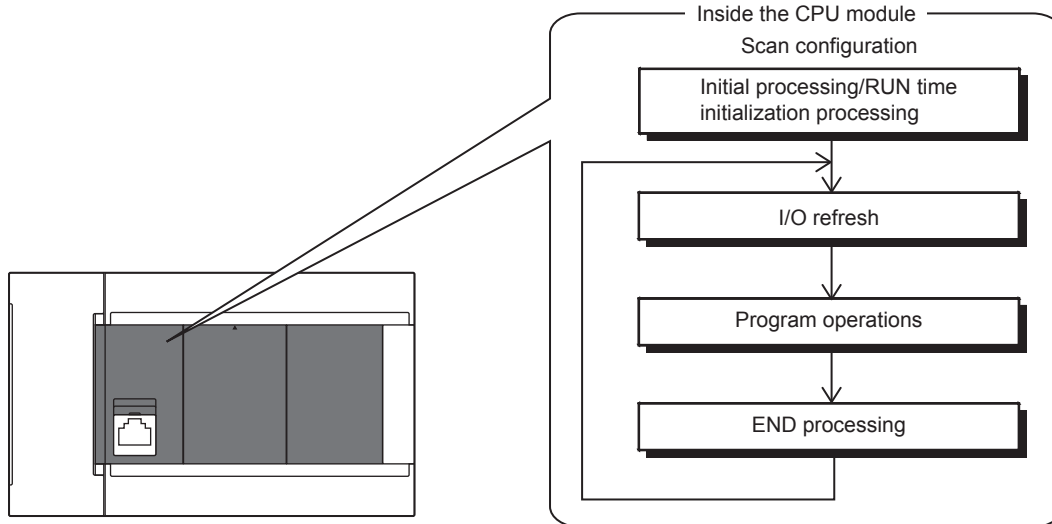

### Initial processing and initialization processing in RUN mode

Initial processing according to CPU module status and initialization processing in the RUN status are explained below.

○: Performed, ×: Not performed

Processing item	CPU module status			
	At power ON	At reset	STOP→RUN after write to PLC <sup>*1</sup>	At STOP→RUN
Initialization of input/output module	○	○	×	×
Boot from SD memory card	○	○	×	×
CPU parameter check	○	○	×	×
System parameter check	○	○	×	×
Initialization of device/label outside latch range (bit device: OFF, word device: 0)	○	○	×	×
Assignment of I/O numbers of input/output module	○	○	×	×
Setting of module parameters	○	○	×	×
Setting of device	○	○	○	○

\*1 Indicates an instance of power OFF→ON or setting to RUN status without a reset after modifying parameters or program in STOP status.

#### Point

At STOP→RUN after writing to the FX5U/FX5UC CPU module, the following operations are added in CPU module firmware version "1.015" or later. The FX5S/FX5UJ CPU modules support the following operations from the first released product.

- When stored in CPU module: Update program file, FB files, global label setting file, initial device value file
- When stored in SD memory card: Update initial device value file

However, if other parameters are changed, the above is not updated. To update, please perform power supply OFF→ON or reset.

## I/O refresh

Execute I/O refresh before starting program operations.

- Input ON/OFF data input from input module/intelligent function module to CPU module
- Output ON/OFF data input from CPU module to output module/intelligent function module

### Point

When executing constant scan, I/O refresh is executed after the constant scan waiting time ends.

## Program operations

Step 0 of each program up to the END/FEND instruction is executed according to program settings. This program is called the "main routine". Main routine programs can be divided into subroutines. (📄 Page 38 Subroutine program)

## END processing

END processing involves the following processes:

- Link refreshing of network modules
- Link refreshing of CC-Link IE Field Network Basic
- Refreshing of intelligent function modules
- Instruction termination processing
- Device/label access service processing
- Resetting of the watchdog timer
- Device collection by the data logging function
- Self-diagnostic processing
- Setting of values to special relays/special registers (set timing: when END processing is executed)

## 1.2 Scan Time

The CPU module repeats the following processing. The scan time is the sum total of each process and execution time.

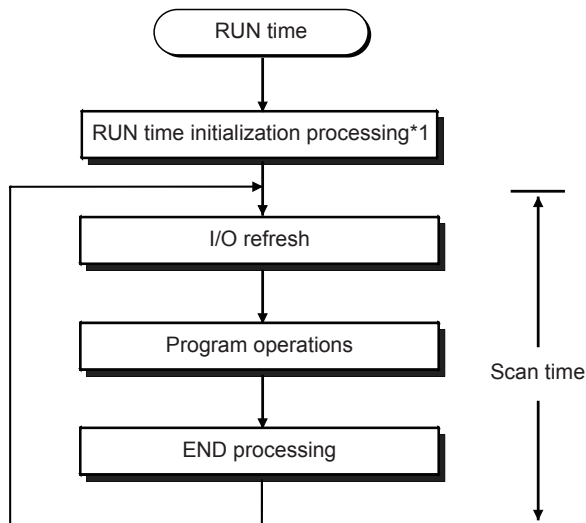

\*1 This process is included in the initial scan time.

# Initial scan time

This refers to the initial scan time when the CPU module is in the RUN mode.

## How to check the initial scan time

The initial scan time can be checked by the following information:

- Value stored in SD518 (initial scan time (ms)), SD519 (initial scan time (μs))
- Program list monitor (📖GX Works3 Operating Manual)

## Monitoring the initial scan time

The initial scan time is monitored by the initial scan time execution monitor time. (📖 Page 114 SCAN MONITORING FUNCTION)

### Initial scan time execution monitor time precautions

- Set an initial execution monitor time longer than the execution time of the initial scan time. An error occurs when the initial scan time exceeds the set initial execution monitor time.
- The measurement error margin of the initial scan execution monitor time is 10ms. For example, if the initial execution monitor time (t) is set to 100ms, an error occurs in the initial scan time in the range 100ms < t < 110ms range.

# 1.3 Program Execution Sequence

When the CPU module enters the RUN status, the programs are executed successively according to the execution type of the programs and execution order setting.

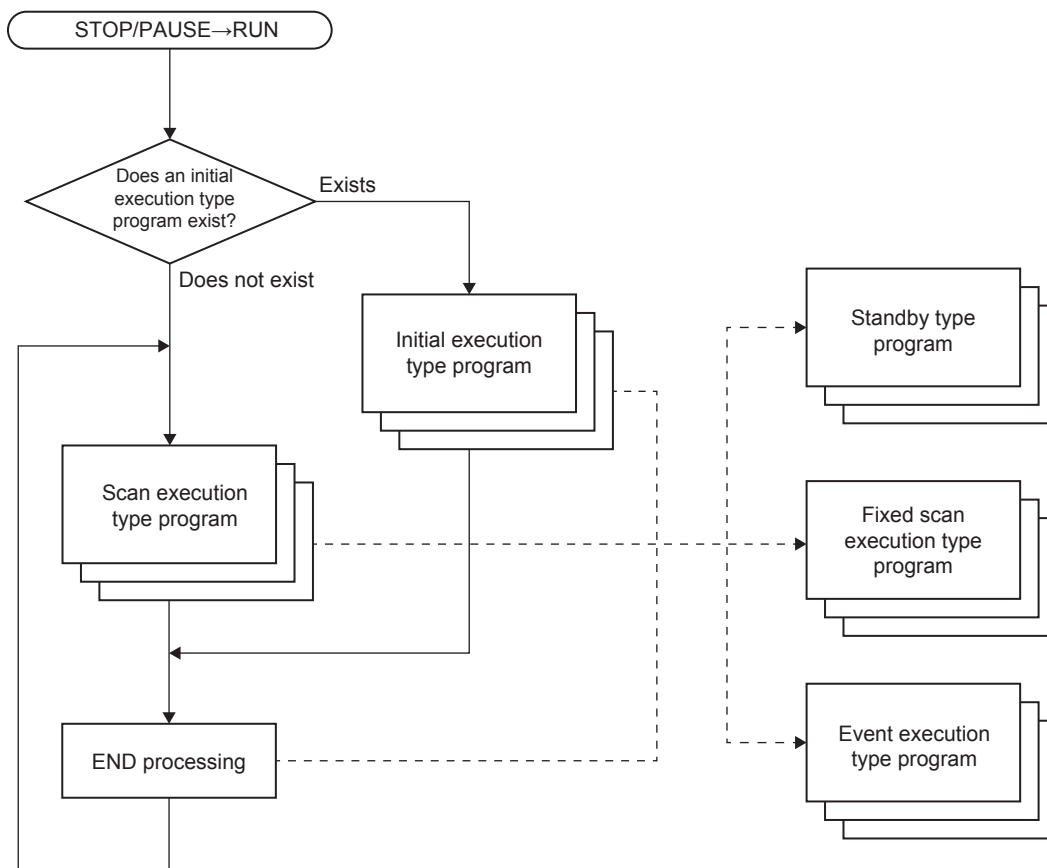

### Point

When the execution type of the programs is the same, the programs are executed in the order in which the execution order was set.

# 1.4 Execution Type of Program

Set the program execution conditions.

## Initial execution type program

This program type is executed only once when the CPU module changes from the STOP/PAUSE to the RUN status. This program type is used for programs, that do not need to be executed from the next scan once they are executed, like initial processing on an intelligent function module.

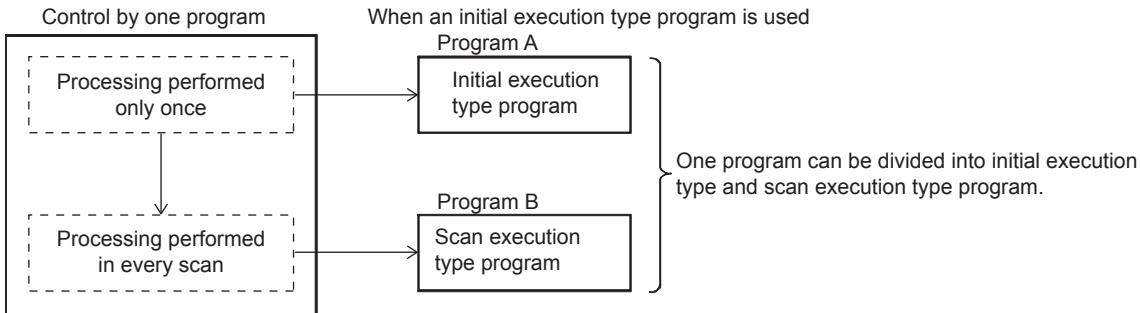

Also, the execution time of initial execution type programs is the same as the initial scan time.

When multiple initial execution type programs are executed, the execution time of the initial execution type programs becomes the time until execution of all initial execution type programs is completed.

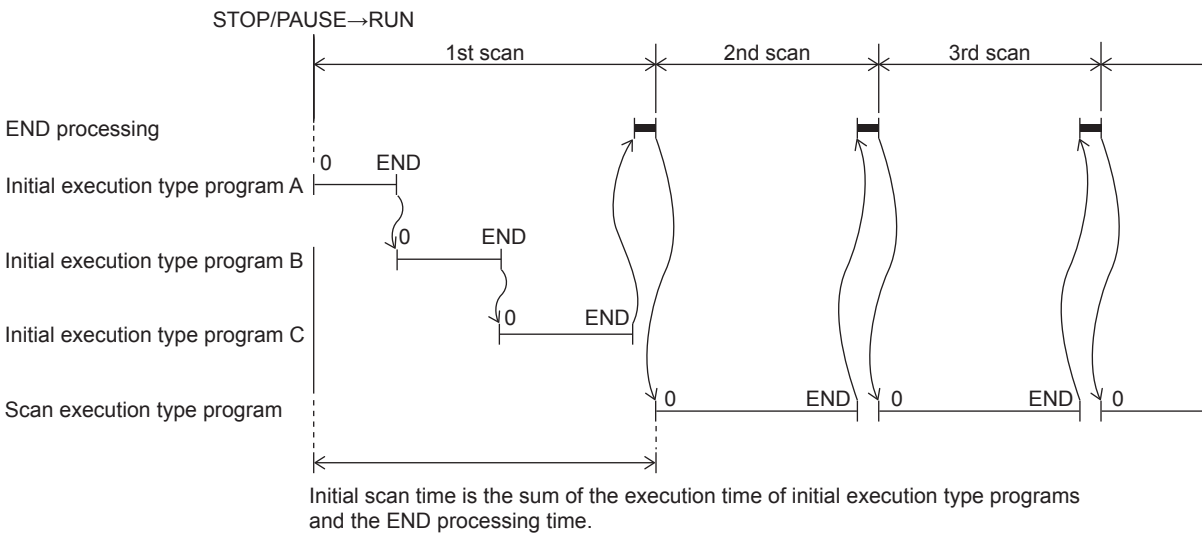

### Precautions

The precautions for initial execution type programs are explained below.

#### ■Restrictions in programming

With initial execution type programs, do not use instructions that require several scans to complete execution (instructions for which completion devices exist).

**Ex.**

e.g. RBFM and WBFM instructions

# Scan execution type program

This program type is executed only once per scan from the scan following the scan where an initial execution type program was executed.

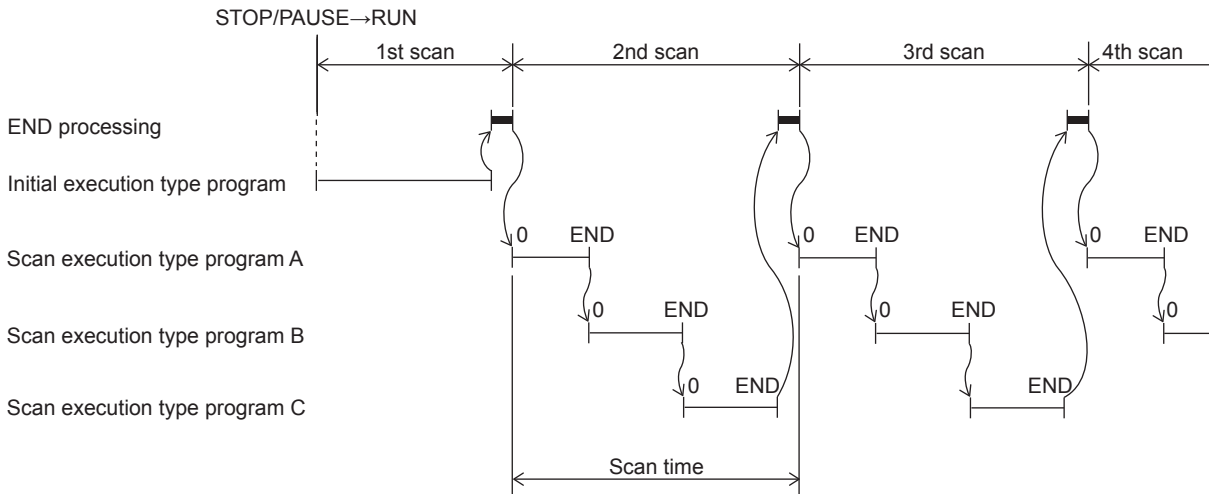

When multiple scan execution type programs are executed, the execution time of the scan execution type programs becomes the time until execution of all scan execution type programs is completed. Note, however, that when a program/event execution type program is executed before a scan execution type program is completed, the execution time of these programs is included in the scan time.

**Point**

- For the SFC program, only the scan execution type program can be specified.
- For SM402 (After RUN, ON for one scan only) and SM8002 (Initial pulse NO contact) in the scan execution type program, the action differs depending on the following.
  - When there is not an initial execution type program: SM402 and SM8002 are executed.
  - When there is an initial execution type program: SM402 and SM8002 are not executed.

# Fixed scan execution type program

An interrupt program which is executed at a specified time interval. Different from the normal interrupt program, this type of program does not require interrupt pointer (I) and IRET instruction to be written (pointer is assigned by parameter). Execution is performed by program file basis.

You can use 4 files of fixed scan execution type programs at the maximum.

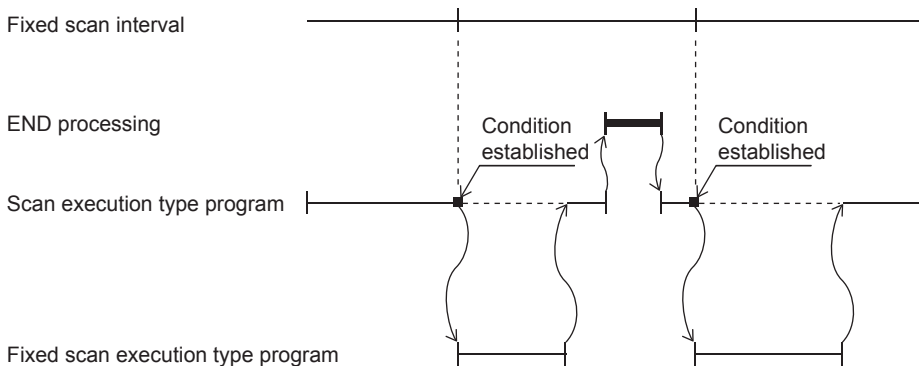

**Point**

To execute a fixed scan execution type program, the EI instruction must be used to enable interrupts.



Make the following settings for fixed scan execution type program in CPU parameter.

- Interrupt pointer setting (Interrupt from internal timer: I28 to I31)
- Fixed scan interval setting

## Interrupt pointer setting

The interrupt pointer (Interrupt from internal timer: I28 to I31) assigned to a fixed scan execution type program is set up.

Navigation window ⇒ [Parameter] ⇒ [Module model name] ⇒ [CPU Parameter] ⇒ "Program Setting" ⇒ "Program Setting" ⇒ "Detailed Setting" ⇒ "Detailed Setting Information"

1. Open the program setting window.
2. Set type as fixed scan.
3. Specify interrupt pointer.

### Window

Execute Order	Program Name	Execution Type	
		Type	Detailed Setting Information
1	MAIN	Scan	
2	MAIN1	Fixed Scan	Interrupt:I31:10 ms
3			
4			
5			

### Displayed items

Item	Description	Setting range	Default
Interrupt Pointer	Set the interrupt pointer which is assigned to fixed scan execution type program.	<ul style="list-style-type: none"> <li>• I28</li> <li>• I29</li> <li>• I30</li> <li>• I31</li> </ul>	I31
Specified Time Intervals	Fixed scan interval setting value is displayed. Setup is performed on another window. (Page 31 Fixed scan interval setting)	—	—

## Fixed scan interval setting

Sets the fixed scan interval setting of the fixed scan execution type program. (It is the same as setting for interrupt from internal timer.)

Navigation window ⇒ [Parameter] ⇒ [Module model name] ⇒ [CPU Parameter] ⇒ "Interrupt Settings" ⇒ "Fixed Scan Interval Setting"

### Window

Item	Setting
<b>Fixed Scan Interval Setting</b>	
Interrupt Setting from Internal Timer	
I28	100 ms
I29	40 ms
I30	20 ms
I31	10 ms

### Displayed items

Item	Description	Setting range	Default	
Interrupt Setting from Internal Timer	I28	Sets the execution interval of I28.	1 to 60000ms (1ms units)	100ms
	I29	Sets the execution interval of I29.	1 to 60000ms (1ms units)	40ms
	I30	Sets the execution interval of I30.	1 to 60000ms (1ms units)	20ms
	I31	Sets the execution interval of I31.	1 to 60000ms (1ms units)	10ms

## Action when the execution condition is satisfied

Performs the following action.

### ■If the execution condition is satisfied before the interrupt is enabled by the EI instruction

The program enters the waiting status and is executed when the interrupt is enabled. Note that if the execution condition for this fixed scan execution type program is satisfied more than once during the waiting status, the program is executed only once when the interrupt is enabled.

### ■When there are two or more fixed scan execution type programs

When the specified time intervals expire in the same timing, the programs are executed in order according to the priority (I31 > I30 > I29 > I28) of the periodic interrupt pointer.

### ■If another or the same execution condition is satisfied while the fixed scan execution type program is being executed

Operates according to the fixed scan execution mode setting.

### ■If the execution condition is satisfied while the interrupt is disabled by the system

Operates according to the fixed scan execution mode setting.

### ■If an interrupt factor occurs during link refresh

Suspends link refresh and executes the fixed scan execution type program. Even while station unit block guarantee is enabled for cyclic data during refresh of such links as CC-Link IE Field Network, if the fixed scan execution type program uses a device specified as the refresh target, station unit block guarantee for cyclic data is not available.

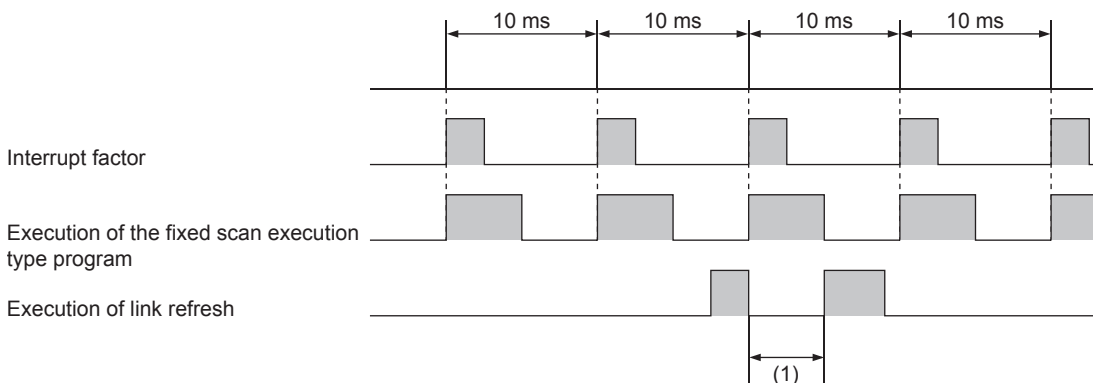

(1) Suspends link refresh and executes the fixed scan execution type program.

### ■When an interrupt is generated during a standby while executing constant scan

Executes the fixed scan execution type program.

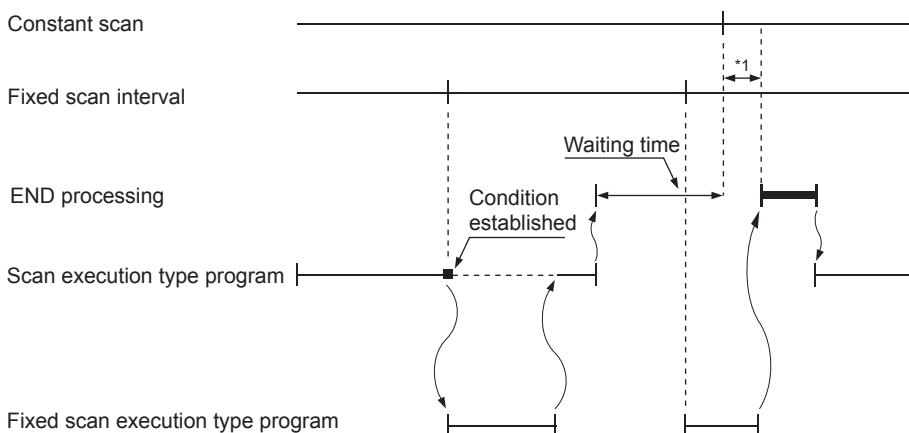

\*1 If processing does not finish during the waiting time, the scan time is extended.

### ■If another interrupt occurs while the fixed scan execution type program is being executed

If an interrupt program is triggered while the fixed scan execution type program is being executed, the program operates in accordance with the interrupt priority.

## Processing when the fixed scan execution type program starts

The same processing as when the interrupt program starts. (Page 43 Processing at startup of interrupt program)

### Fixed scan execution mode

If execution condition for a fixed scan execution type program and fixed cycle interrupt (I28 to I31) based on the internal timer of the CPU module is satisfied while interruption is disabled, the operation of the program execution after interruption becomes allowed is specified. However, if execution condition is satisfied while interruption is set to be disabled because of a DI instruction or the like, this is out of the scope of the fixed scan execution mode.

#### Point

"Interrupts disabled" refers to the following:

- A program having an interrupt priority higher than or the same as the corresponding program is currently being executed.
- The corresponding program is currently being executed.
- Program execution is currently at a part in which interrupts are disabled by the system.

### Operation in the fixed scan execution mode

This section describes the operation which can be performed in the fixed scan execution mode.

#### • Execution Count Takes Priority

The program is executed for all the pending number of executions so that it can be executed the same number of times as execution condition was satisfied.

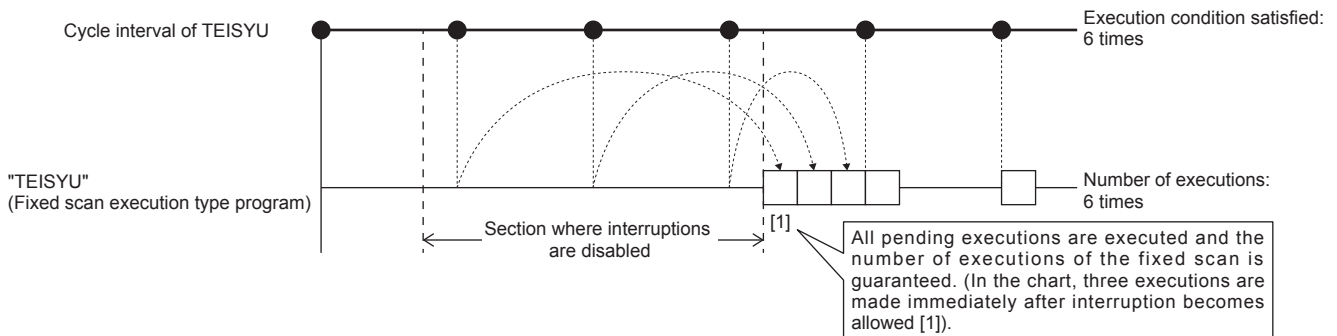

#### • Precede Fixed Scan

When the waiting for execution, one execution is made when interrupt becomes allowed. Even if execution condition was satisfied twice or more, only one execution is performed.

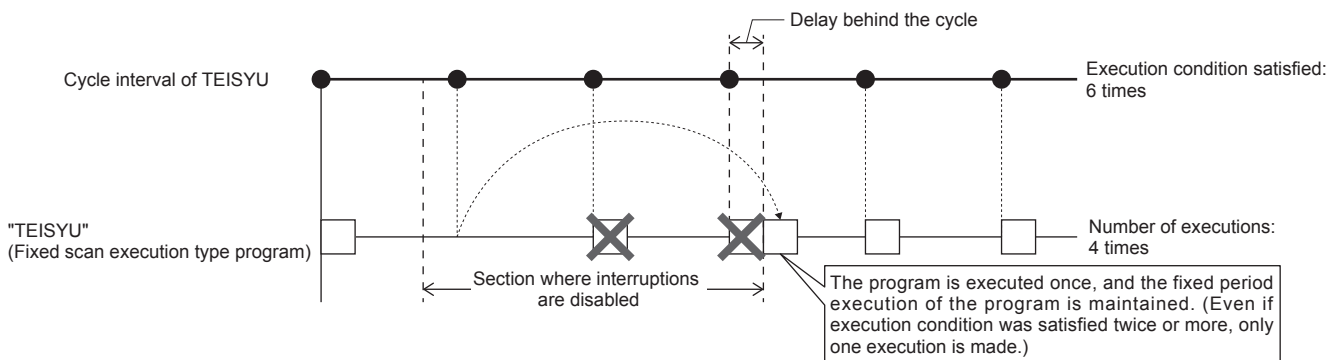

## ■ Fixed scan execution mode setting

Use the fixed scan execution mode setting.

Navigation window ⇒ [Parameter] ⇒ [Module model name] ⇒ [CPU Parameter] ⇒ "Interrupt Settings" ⇒ "Fixed Scan Execution Mode Setting"

### Window

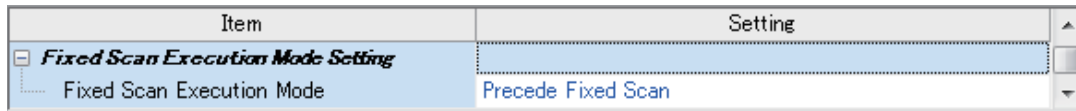

### Displayed items

Item	Description	Setting range	Default
Fixed Scan Execution Mode	For Precede Fixed Scan, the periodicity of the program is maintained. For Execution Count Takes Priority, the program is executed for all pending number of executions.	<ul style="list-style-type: none"> <li>Precede Fixed Scan</li> <li>Execution Count Takes Priority</li> </ul>	Precede Fixed Scan

## Event execution type program

Execution of this program type is triggered by a user-specified event. (Page 34 Trigger type)

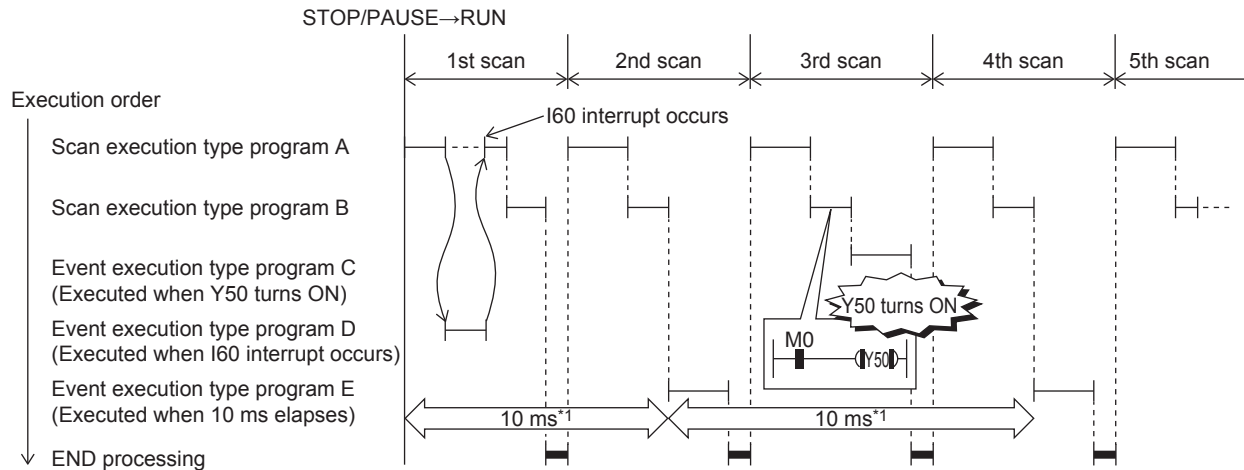

\*1 Measurement of elapsed time is 10ms or more because it is determined depending on the scan time.

### Trigger type

Triggers for event execution type programs are explained below. (Page 36 Trigger setting)

### ■ Generation of interrupt by interrupt pointer (I)

The program is executed once, immediately, when a specified interrupt cause is generated. An interrupt pointer label can be appended by adding the FEND instruction to a different program, and the program description partitioned by the IRET instruction can be turned into an exclusive program.

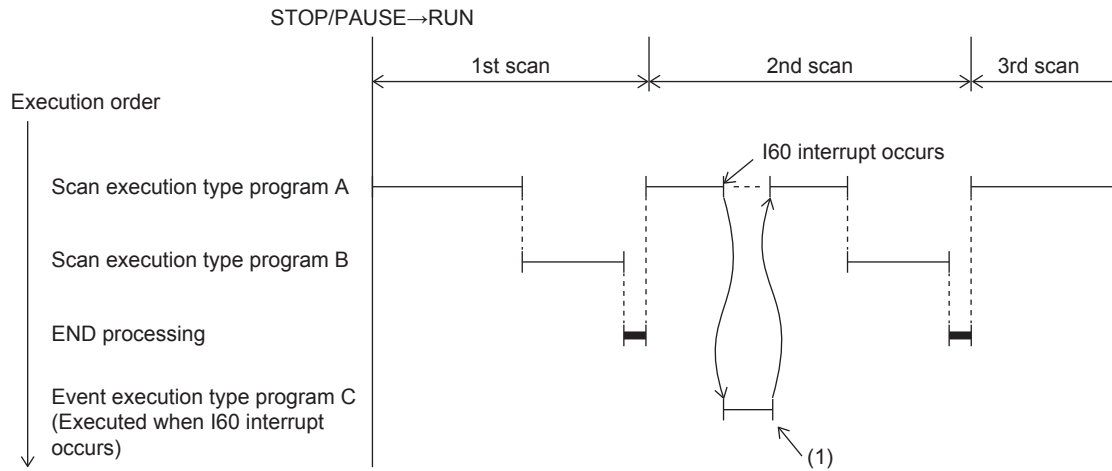

(1) Event execution type program C is executed immediately when the specified event is generated.

#### • Specifiable interrupt pointer (I)

Specifiable interrupt pointers are I0 to I15, I16 to I23, and I50 to I177.

#### Point

Execution conditions for the event execution type program which is triggered by interrupt occurred by the interrupt pointer (I) are the same as those for general interrupt programs. (Page 40 Operation when an interrupt is generated)

### ■ Bit data ON (TRUE)

When it is the turn of the corresponding program to be executed, the program is executed if the specified bit data is ON. This eliminates the need for creating a program for monitoring triggers in a separate program. After the specified bit data changes from ON (TRUE) to OFF (FALSE) and it is the turn of the corresponding event execution type program to be executed, output (Y) currently used in the corresponding program and the current values of timer (T) can be cleared.

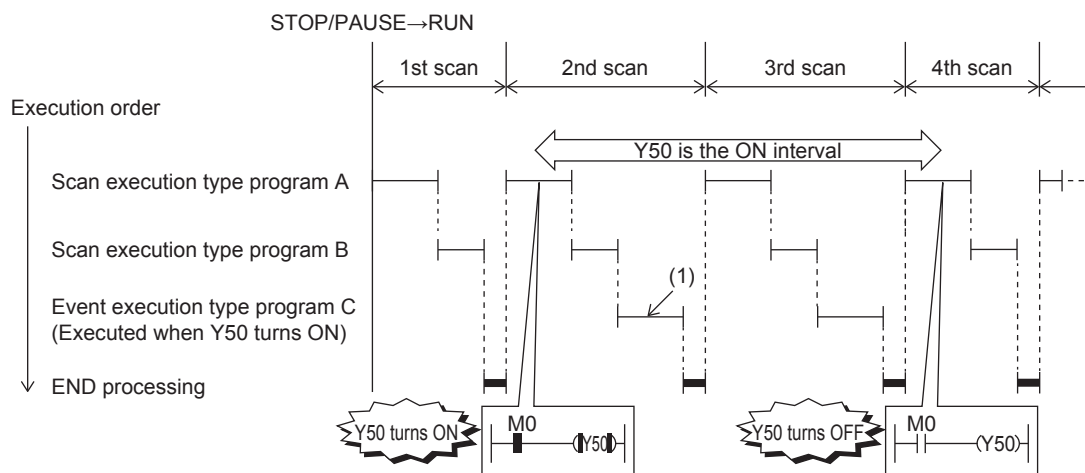

(1) The program is executed if Y50 is ON when it is the turn of event execution type program C to be executed.

Applicable devices are as follows.

Item	Description	
Device*1	Bit device	X (DX), Y, M, L, F, SM, B, SB
	Bit specification in word device	D, SD, W, SW, R, U□\G□

\*1 Indexed devices cannot be specified.

## ■Elapsed time

The program is executed once when it is the turn of the corresponding program to be executed first after the CPU module is run and the specified time has elapsed. For second execution onwards, the time is re-calculated from the start of the previous event execution type program. When it is the turn of the corresponding program to be executed first after specified time has elapsed, program execution is repeated. Output (Y) currently used in the corresponding program and the current values of timer (T) can be cleared at the next scan following execution of the corresponding program. This will not be always executing an interrupt at a constant cycle but can be used when executing a specified program after a specified time has elapsed.

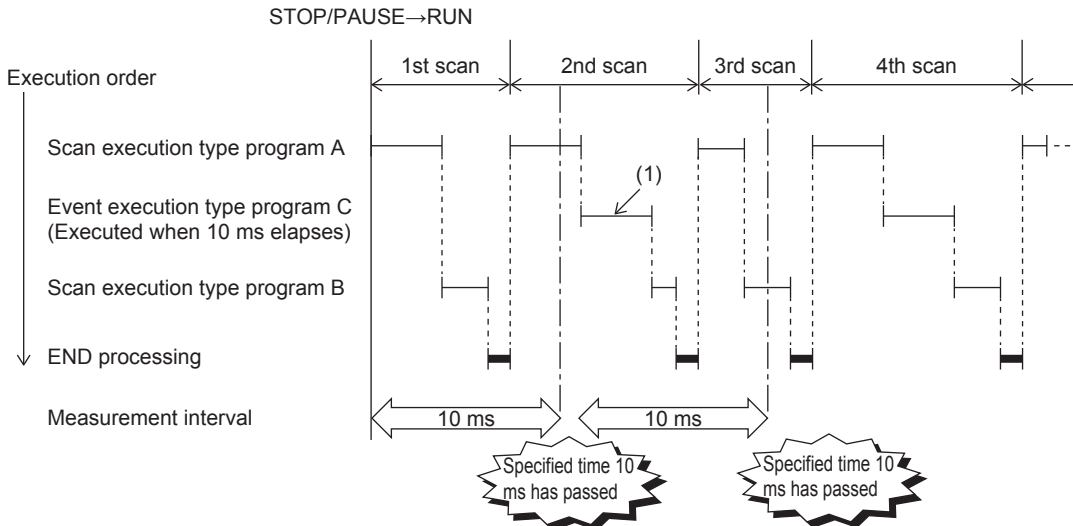

(1) When it is the turn of the first execution after the specified time has elapsed, event execution type program C is executed.

### Point

Output and timer current values are not cleared even when the program is set so that output and timer current values are cleared, if the scan time is longer than the elapsed time set value.

## Trigger setting

Use the event execution type detail setting.

Navigation window ⇒ [Parameter] ⇒ [Module model name] ⇒ [CPU Parameter] ⇒ "Program Setting"

### Operating procedure

"Program Setting" window

Item	Setting
Program Setting	<Detailed Setting>

"Detailed Setting" window

Execute Order	Program Name	Execution Type	
		Type	Detailed Setting Information
1	MAIN	Event	Bit ON/Do Not Clear
2			

"Event Execution Type Detailed Setting" window

Item	Setting
Trigger Type	ON of Bit Data (TRUE)
- Interruption Occurrence	
- ON of Bit Data (TRUE)	
- Clear Output and Current Value of Timer	Do Not Clear
- Passing Time	
- Unit	ms
- Clear Output and Current Value of Timer	Do Not Clear

1. Click "Detailed Setting" on the Program Setting.
2. Select the program name and set the execution type to "Event".
3. Click "Detailed Setting Information".
4. Set the trigger type to execute the event execution type program.

## Displayed items

Item	Description	Setting range	Default
Interruption Occurrence	Sets the interrupt pointer used as the trigger.	I0 to I23, I50 to I177	—
ON of Bit Data (TRUE)	Sets the device used as the trigger.	☞ Page 35 Bit data ON (TRUE)	—
Clear Output and Current Value of Timer	Sets that the current values of the output (Y), and timer (T) used in this program are cleared at the execution turn of the event execution type program that comes after the specified bit data is OFF.	<ul style="list-style-type: none"> <li>• Do Not Clear</li> <li>• Clear</li> </ul>	Do Not Clear
Passing Time	Unit	Sets the time passed.	—
	Clear Output and Current Value of Timer	Sets that the current values of the output (Y), and timer (T) used in this program are cleared at the execution turn of the event execution type program that comes after the specified time passes.	<ul style="list-style-type: none"> <li>• Do Not Clear</li> <li>• Clear</li> </ul>

### Point

When "Clear Output and Current Value of Timer" is enabled together with "ON of Bit Data (TRUE)" or "Passing Time", the current values of the output (Y) and timer (T) of this program can be cleared at the first execution turn of this program that comes after the trigger turns OFF.

## Stand-by type program

This program is executed only when there is an execution request.

### Saving programs in library

Subroutine programs or interrupt programs are saved as standby type programs so that they can be used when controlled separately from the main routine program. Multiple subroutine programs and interrupt programs can be created in one standby type program.

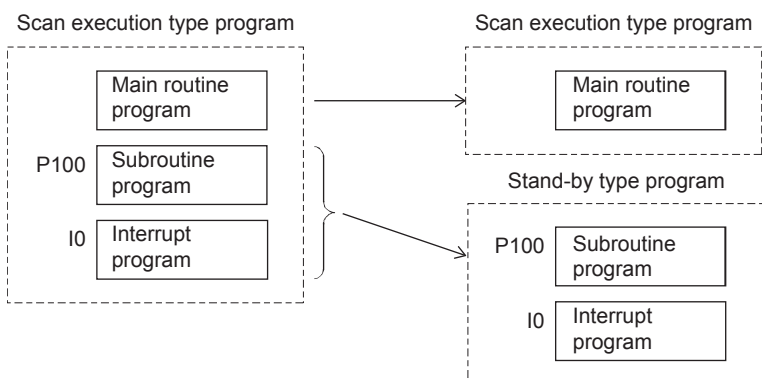

### How to execute

Execute standby type programs as follows.

- Create sub-routine programs and interrupt programs in the standby type program which is called up by a pointer, etc. or when an interrupt is generated.

# 1.5 Program Type

Programs that use pointers (P) or interrupt pointers (I) are explained below.

## Subroutine program

This is the program from pointer (P) up to the RET instruction. Subroutine programs are executed only when they are called by the CALL instruction. Pointer type labels also can be used instead of pointers (P). The applications of subroutine programs are as follows:

- By grouping programs that are executed multiple times in one scan into a single subroutine program, the number of steps in the entire program can be reduced.
- A program that is executed only under certain conditions can be saved as a subroutine program which shortens the scan time proportionately.

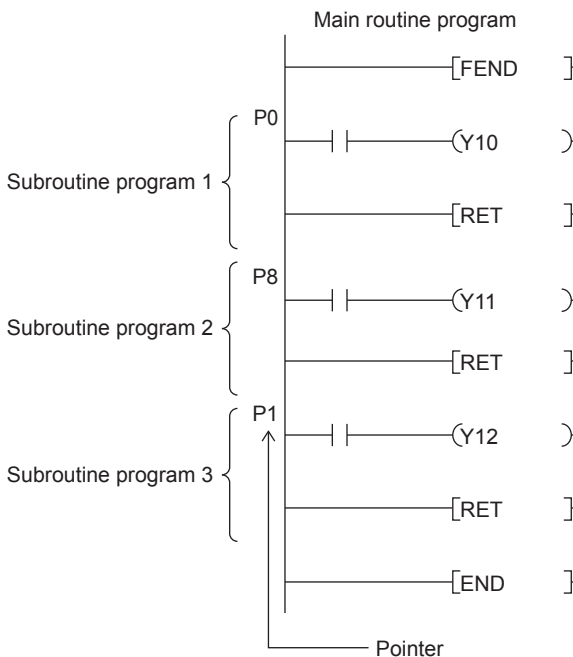

### Point

- Subroutine programs can also be managed as separate programs by turning them into standby type programs. (Page 37 Stand-by type program)
- Pointers need not be programmed starting with the smallest number.

## Precautions

The precautions when using subroutine programs are explained below.

- Do not use timers (T, ST). Note, however, that timers can be used when a timer coil (OUT T□ instruction) is always executed only once in one scan.
- An error occurs when program execution returns to the call source program and the program is terminated without using the RET instruction.
- An error occurs when there is no pointer (P) or pointer type global label in FB or FUN.
- When the CALL instruction is used in the operation output of the step of the SFC program, even though the transition condition is established and the step is deactivated, the output of the call destination is not turned OFF. When turning OFF the output of the call destination, use the XCALL instruction.



# Interrupt program

This is the program from interrupt pointer (I) up to the IRET instruction.

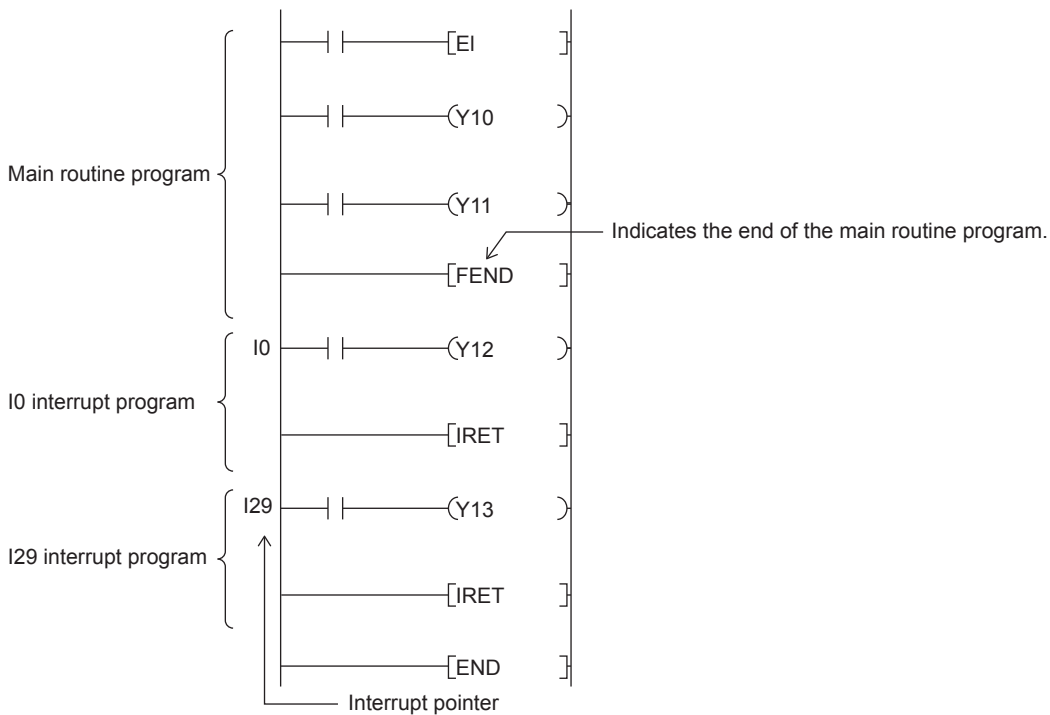

When an interrupt is generated, the interrupt program corresponding to that interrupt pointer number is executed. Note, however, that interrupt enabled status must be set with the EI instruction before executing the interrupt program.

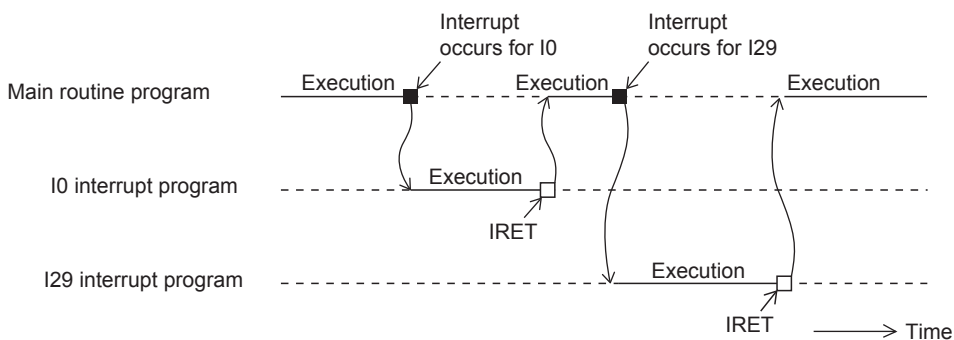

## Point

- Only one interrupt program can be created with one interrupt pointer number.
- Interrupt pointers need not be programmed starting with the smallest number.
- Interrupt programs can also be managed as separate programs by turning them into standby type programs. ( [Page 37 Stand-by type program](#) )

## Operation when an interrupt is generated

Operation when an interrupt is generated is explained below.

### ■If an interrupt cause occurs when interrupt is disabled (DI)

The interrupt that was generated is stored, and the stored interrupt program is executed the moment that the status changes to interrupt enabled. An interrupt is stored only once even if the same interrupt is generated multiple times. Note, however, that all interrupts cause are discarded when interrupt disable is specified by the IMASK and SIMASK instructions.

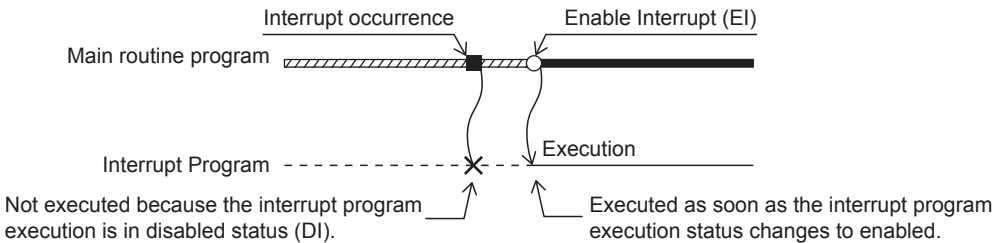

### ■When an interrupt cause is generated by a PAUSE status

The interrupt program is executed the moment that the CPU module changes to the RUN status and the status changes to interrupt enabled. An interrupt is stored only once when the same interrupt is generated multiple times before the CPU module changes to the RUN status.

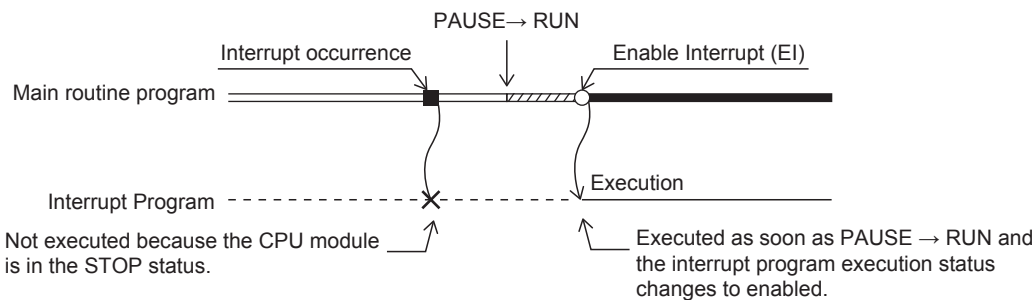

### ■If an interrupt factor occurs during link refresh

Suspends link refresh and executes the interrupt program. Even though station unit block guarantee is enabled for cyclic data during refresh of such links as CC-Link IE Field Network, if the interrupt program uses a device specified as the refresh target, station unit block guarantee for cyclic data is not available.

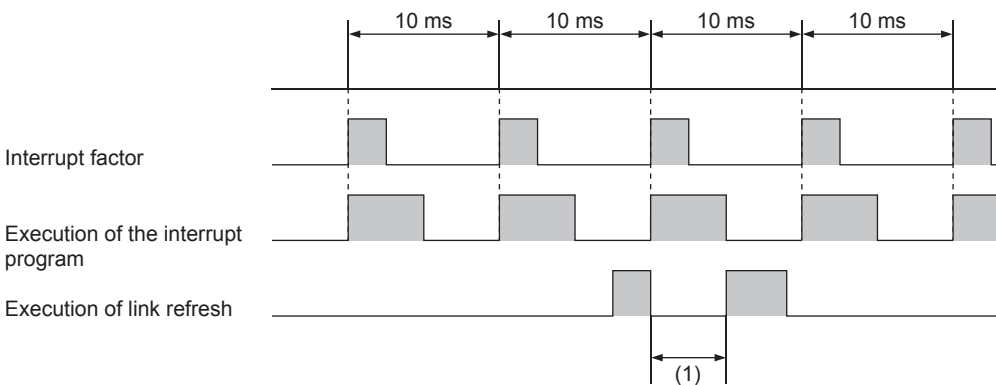

(1) Suspends link refresh and executes the interrupt program.

**When multiple interrupts are generated at the same time while in an interrupt enabled status**

Interrupt programs are executed in order starting from program having the highest priority. Interrupt programs also run in order of priority rank when multiple interrupt programs having the same priority are generated simultaneously.

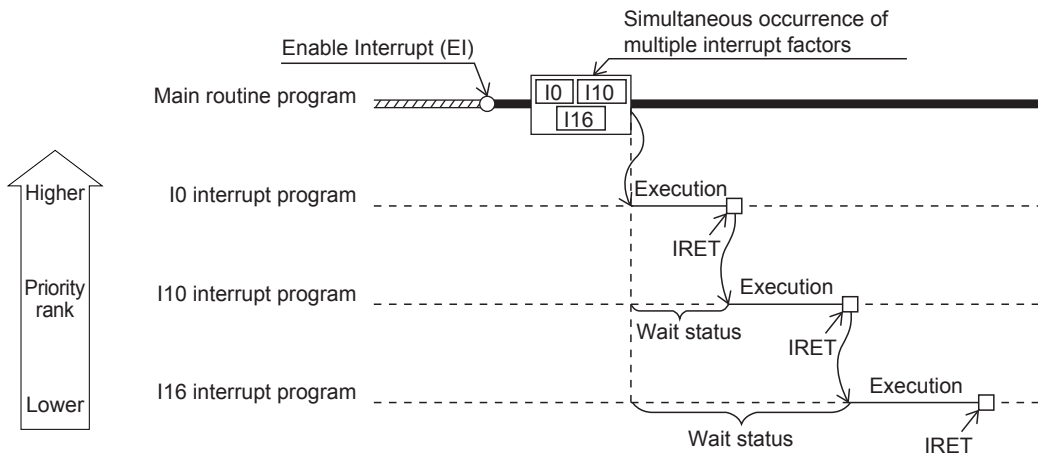

**When an interrupt is generated during a standby while executing constant scan**

The interrupt program for that interrupt is executed.

**When another interrupt is generated during execution of the interrupt program**

If an interrupt such as a fixed scan execution type program (including an interrupt which triggers the event execution type program) is triggered while an interrupt program is being executed, the program operates in accordance with the interrupt priority.

**If an interrupt cause with the same or a lower priority occurs while the interrupt program is being executed**

- For I0 to I23 and I50 to I177

The interrupt cause that occurred is memorized, and the interrupt program corresponding to the cause will be executed after the running interrupt program finishes. An interrupt is stored only once even if the same interrupt is generated multiple times.

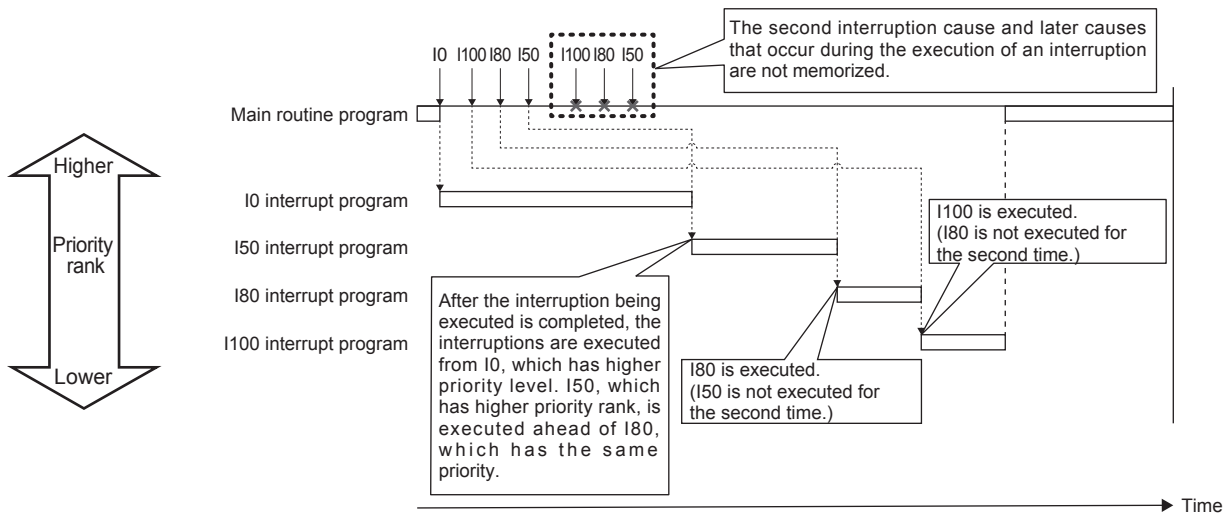

- For I28 to I31

The interrupt cause that occurred is memorized, and the interrupt program corresponding to the cause will be executed after the running interrupt program finishes. If the same interrupt cause occurs multiple times, it will be memorized once but operation at the second and later occurrences depends on setting of the fixed scan execution mode. (Page 33 Fixed scan execution mode)

When "Execution Count Takes Priority" is enabled, the interrupt program corresponding to the memorized interrupt causes will be executed after the running interrupt program finishes. When "Precede Fixed Scan" is enabled, the second and later occurrences will not be memorized.

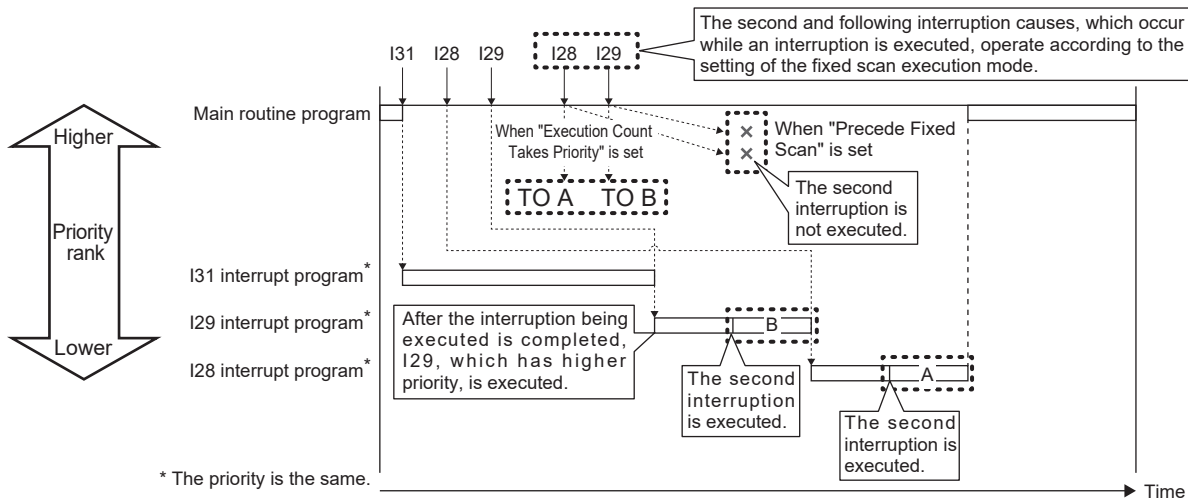

**■ If the same interrupt cause occurs while the interrupt program is being executed**

- For I0 to I23 and I50 to I177

The interrupt cause that occurred is memorized, and the interrupt program corresponding to the cause will be executed after the running interrupt program finishes. An interrupt is stored only once even if the same interrupt is generated multiple times.

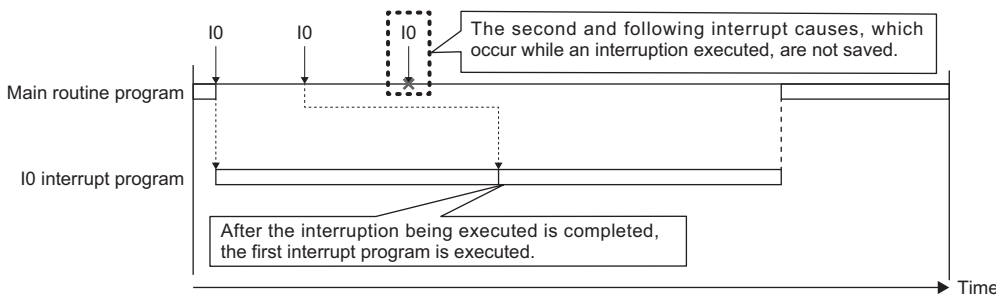

- For I28 to I31

The interrupt cause that occurred is memorized, and the interrupt program corresponding to the cause will be executed after the running interrupt program finishes. If the same interrupt cause occurs multiple times, it will be memorized once but operation at the second and later occurrences depends on setting of the fixed scan execution mode. (Page 33 Fixed scan execution mode)

When "Execution Count Takes Priority" is enabled, the interrupt program corresponding to the memorized interrupt cause will be executed after the running interrupt program finishes. When "Precede Fixed Scan" is enabled, the second and later occurrences will not be memorized.

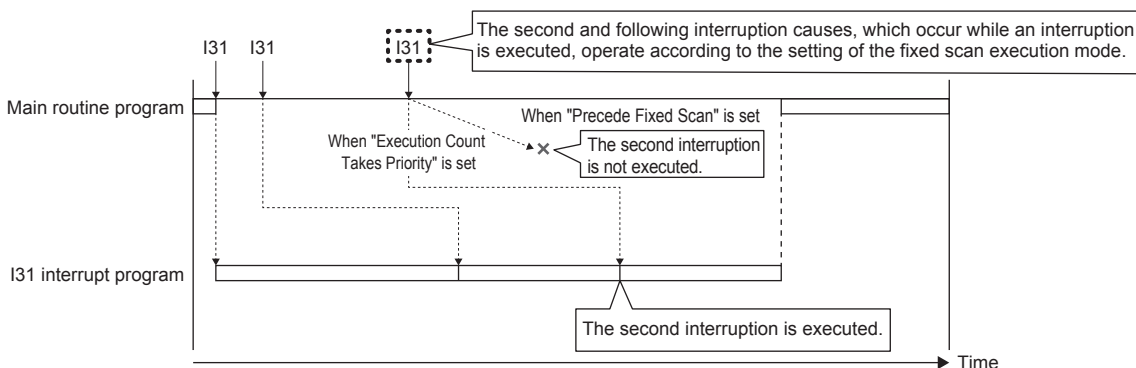

## Setting the interrupt cycle

Set the interrupt cycle of interrupts I28 to I31 using the internal timer of the interrupt pointer.

Navigation window ⇒ [Parameter] ⇒ [Module model name] ⇒ [CPU Parameter] ⇒ "Interrupt Settings" ⇒ "Fixed Scan Interval Setting"

### Window

Item	Setting
<b>Fixed Scan Interval Setting</b>	
Interrupt Setting from Internal Timer	
I28	100 ms
I29	40 ms
I30	20 ms
I31	10 ms

### Displayed items

Item	Description	Setting range	Default	
Interrupt Setting from Internal Timer	I28	Sets the execution interval of I28.	1 to 60000ms (1ms units)	100ms
	I29	Sets the execution interval of I29.	1 to 60000ms (1ms units)	40ms
	I30	Sets the execution interval of I30.	1 to 60000ms (1ms units)	20ms
	I31	Sets the execution interval of I31.	1 to 60000ms (1ms units)	10ms

## Processing at startup of interrupt program

Processing is as follows when an interrupt program is started up.

- Purge/restore of index registers (Z, LZ)

### ■Purge/restore of index registers (Z, LZ)

When an interrupt program is started up, the values of the index registers (Z, LZ) in the currently executing program are purged, and those values are handed over to the interrupt program. Then, when an interrupt program is terminated, the purged values are restored to the currently executing program.

## Precautions

The precautions for interrupt programs are explained below.

### ■Restrictions in programming

- The PLS/PLF instructions execute OFF processing at the scan following instruction execution. ON devices remain ON until the interrupt program runs again and the instruction is executed.
- Only a routine timer can be used in an interrupt program. Timers (T, ST) cannot be used.

### ■Splitting of data

Processing may be interrupted during instruction execution and an interrupt programs can be executed. Accordingly, splitting of data might occur if the same devices are used by both the interrupt program and the program that is aborted by the interrupt. Implement the following preventive measure.

- Set instructions that will result in inconsistencies if interrupted to "interrupt disabled" using the DI instruction.
- When using bit data, ensure that the same bit data is not used by both the interrupt program and the program that is aborted by the interrupt.

### ■Interrupt precision is not improved

If interrupt precision is not improved, this might be remedied by implementing the following:

- Give higher priority to the interrupt that needs higher precision.
- Use an interrupt pointer with high interrupt priority order.
- Recheck the section of interruption disabled.

# 2 PROCESSING OF OPERATIONS ACCORDING TO CPU MODULE OPERATION STATUS

The CPU module has three operation statuses as follows:

- RUN status
- STOP status
- PAUSE status

Processing of operations on the CPU module in each status is explained below.

## Processing of operations in RUN status

In the RUN mode, operations in the sequence program are executed repeatedly in order step 0→END (FEND) instruction→step 0.

### ■Output when CPU module enters RUN mode

Operation results are output after the sequence program is executed for the duration of one scan.

The device memory other than the output (Y) holds the state immediately before the RUN state. However, if device initial value is set up, this initial value is set.

### ■Processing time until start of operation

The processing time from the CPU module switching from STOP→RUN up to start of execution of operations in the sequence program fluctuates according to the system configuration and parameter settings. (Normally, this time is within one second.)

## Processing of operations in STOP status

In the STOP status, execution of operations in the sequence program is stopped by the RUN/STOP/RESET switch or a remote stop. The CPU module also enters the STOP status when a stop error occurs.

### ■Output when CPU module enters STOP status

When the CPU module enters the STOP status, all output points (Y) turn OFF. For device memory other than outputs (Y), non-latch devices are cleared and latch devices are held.

However, when SM8033 is on and CPU module switches RUN→STOP, it is possible to hold an output state and the current value of a device.

## Precautions

When the SM8033 is ON, PC write with an engineering tool cannot be performed.

## Processing of operations in paused status

In a paused status, execution of operations in the sequence program is stopped after one scan execution but with outputs and device memory states held, by a remote pause.

## Processing of operations by the CPU module during switch operations

Processing of operations by the CPU module is as follows according to the RUN or STOP mode.

RUN/STOP status	Processing of operations by CPU module			
	Processing of operations in sequence program	External output	Device memory	
			Other than Y	Y
RUN→STOP	The program is executed up to the END instruction and then stops.	All output points turn OFF.	Latch devices are held, and non-latch devices are cleared.	All output points turn OFF.
STOP→RUN	Program execution starts from step 0.	Operation results are output after the PLC is run for the duration of one scan.	The states of device memories immediately before the CPU module entered the RUN mode are held. Note, however, that when device initial values are set, the device initial values are set.	Operation results are output after the PLC is run for the duration of one scan.

2

### Point

The CPU module performs the following processing regardless of RUN or STOP status or PAUSE status.

- Refreshing of input/output modules
- Automatic refreshing of intelligent function modules
- Self-diagnostic processing
- Device/label access service processing
- Setting of values to special relays/special registers (set timing: when END processing is executed)

For this reason, the following operations can be performed even in the STOP status or paused status:

- Monitoring of I/O or test operations by the engineering tool
- Reading/writing from external device using SLMP
- N:N Network
- MODBUS RTU slave

# 3 CPU MODULE MEMORY CONFIGURATION

## 3.1 Memory Configuration

CPU module memory is explained below.

### Memory configuration

The configuration of CPU module memory is explained below.

Memory type		Application
CPU built-in memory	Data memory	The following files are stored in this memory: <ul style="list-style-type: none"> <li>• Program files, FB files</li> <li>• Restored information files</li> <li>• Parameter files</li> <li>• Files that contain device comments, etc.</li> </ul>
	Device/label memory	Data areas for internal devices/labels, etc. are located in this memory.
	Signal flow memory	This memory is used to memorize the execution status of the instruction in the last scan.
	Temporary area	This memory is used temporarily by the system during the scan process. It is used as the label defined by the function or the instruction operand added by the system.
SD memory card		This is for storing files that contain device comments, etc. and folders and files that are created by SD memory card functions.

### Data memory

The following files are stored in data memory.

Category	File type	Max. number of files	Storage area size	Remarks
Program	Program file	32	1 Mbytes	—
	FB files	16 (Up to 15 for user)		—
Restored information	Restored information files	48	1 Mbytes	—
Parameters	Parameter files common to system	1	1 Mbytes	—
	CPU parameter file	1		—
	Module parameter file	1		—
	Module extension parameter	18		—
	Remote password	1		—
	Device data storage file	1		—
	Global label setting file	1		—
	Data logging setting file	4		—
	Memory dump setting file	1		—
	Device initial values file	1		—
	Device station parameter file <sup>*1</sup>	80 <sup>*2</sup>		—
Firmware update prohibited file	1	—		
Comments	Device comment file	1	2 Mbytes	—

\*1 Only FX5U/FX5UC CPU module is supported.

\*2 When the firmware version of the FX5U/FX5UC CPU module is "1.230" or earlier, the maximum number of the files is 60.



## Device/label memory

Device/label memory has the following areas.

Area	Storage area size	Application
Device/label memory (standard)	48 K words	<ul style="list-style-type: none"> <li>■FX5S/FX5UJ CPU module</li> <li>• R, W, SW, labels, and latch labels are fixed in the memory.</li> </ul>
	63 K words	<ul style="list-style-type: none"> <li>■FX5U/FX5UC CPU module</li> <li>• R, W, SW, labels, and latch labels can be placed in this memory in variable lengths.</li> <li>• R and W can be backed up in the event of a power interruption only when the optional battery is installed. Also, latch label capacity can be increased when the battery is installed.</li> </ul>
Device/label memory (fast)	12 K words	<ul style="list-style-type: none"> <li>■FX5S/FX5U/FX5UC CPU module</li> <li>• Bit devices, T, ST, C, LC, D, Z, and LZ are fixed in the memory.</li> <li>■FX5U/FX5UC CPU module</li> <li>• Bit devices, T, ST, C, LC, D, Z, LZ, labels, and latch labels can be placed in this memory in variable lengths.</li> </ul>

## Signal flow memory

This memory is used to memorize the execution status of the instruction in the last scan. The CPU module judges whether to execute a rising/falling edge execution instruction by referring to the signal flow memory.

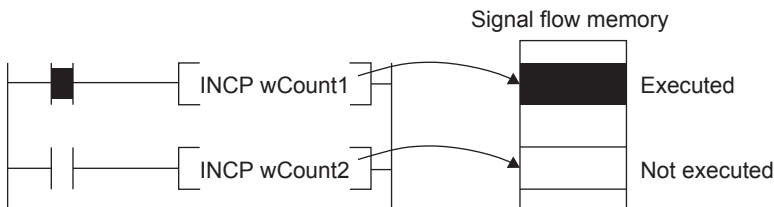

The execution status of the last instruction is stored in the signal flow memory in two ways: executed or not executed. The instructions that refer to the signal flow memory judge whether to execute a rising/falling edge execution instruction depending on the input condition of the instruction and the execution status of the last instruction stored in the signal flow memory.

- For a program, the same number of areas as steps of the program are assigned to the signal flow memory (for program).
- For a function, the signal flow memory is not assigned since the instructions that refer to the last execution status of the signal flow memory cannot be used in the function.
- For a subroutine-type function block, the same number of areas as the function block steps are assigned to the signal flow memory (for FB). Different areas are assigned to each instance. When the macro type function block is called from the subroutine type function block, the areas including the ones used for the macro type function block are assigned.
- For a macro type function block, the same number of areas as the number of steps of the macro type function block are assigned to the signal flow memory (for program).

For instances of the function block, refer to the following.

📖 MELSEC iQ-F FX5 Programming Manual (Program Design)

### Point

The signal flow unit is 1 bit.

[FX5S/FX5UJ CPU module]

The program capacity is fixed at 48000 steps, and the capacity of the signal flow memory is as follows.

- Signal flow memory (for program): 48000 step (6000 byte)
- Signal flow memory (for FB): 131072 step (16K byte)

[FX5U/FX5UC CPU module]

The capacity of the signal flow memory varies according to the program capacity setting.

- Signal flow memory (for program)
  - 64000 step...64000 step (8000 byte)
  - 128000 step...128000 step (16000 byte)
- Signal flow memory (for FB)
  - 64000 step...131072 step (16K byte)
  - 128000 step...262144 step (32K byte)

## Temporary area

This area is used temporarily by the system during the scan process. It is used as the label defined by the function or the instruction operand added by the system.

Part of the temporary area is occupied when execution of the function or instruction is started. The area is released when the execution is completed.

Examples of changes in the state of temporary area when executing a function are shown below.

### Program example

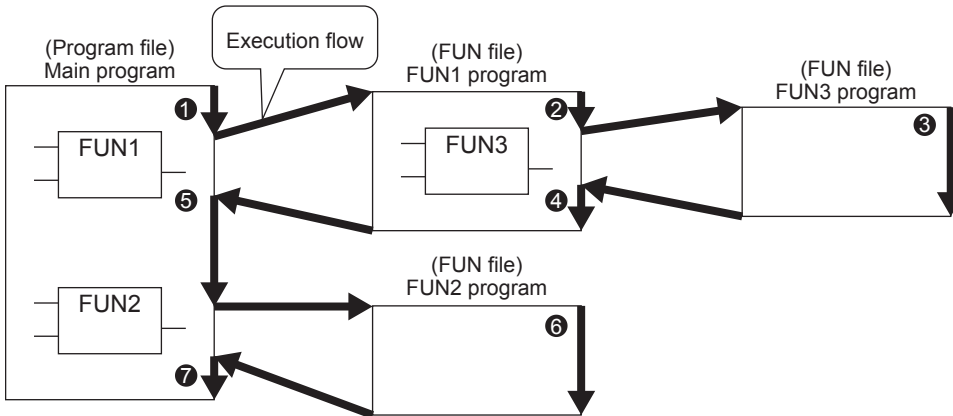

### Changes in the state of temporary area

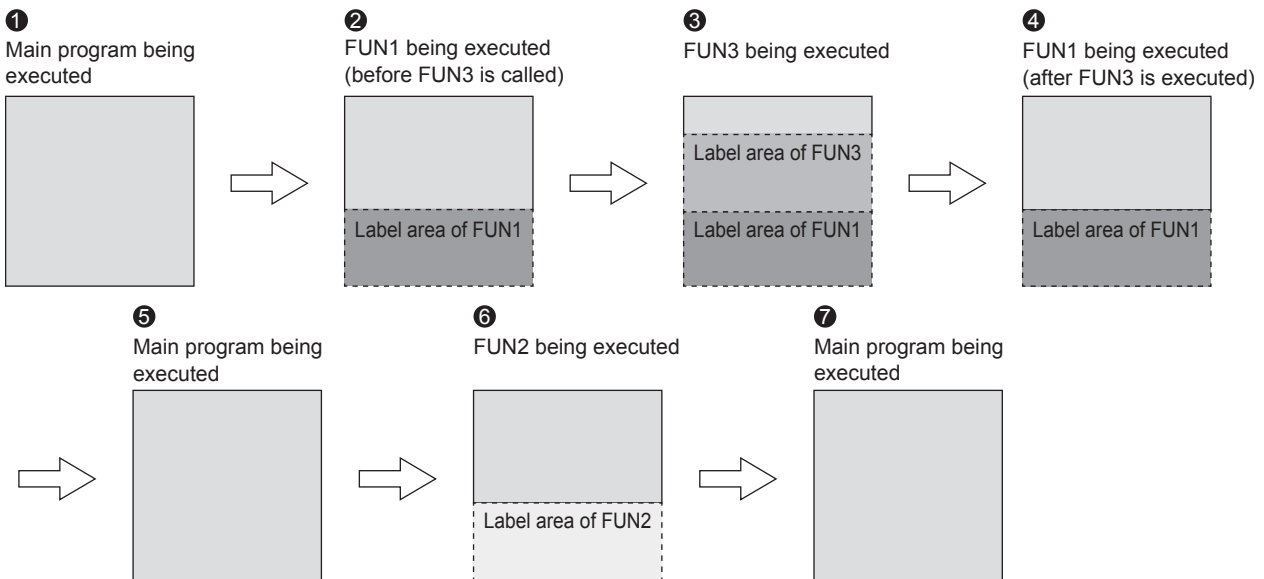

#### Point

[FX5S/FX5UJ CPU module]

The capacity of temporary area is 32767 word.

[FX5U/FX5UC CPU module]

The capacity of the temporary area varies according to the program capacity setting.

- 64000 step...700 word
- 128000 step...32767 word

## SD memory card

The following files are stored in SD memory card.

Category	File type	Max. number of files	Remarks
Program	Program file	32	—
	FB files	16 (Up to 15 for user)	—
Parameters	Parameter files common to system	1	—
	CPU parameter file	1	—
	Module parameter file	1	—
	Module extension parameter	18	—
	Memory card parameter	1	—
	Remote password	1	—
	Global label setting file	1	—
	Data logging setting file	4	—
	Initial device value file	1	—
	Device station parameter file <sup>*1</sup>	80 <sup>*2</sup>	—
Comments	Device comment file	1	—
Extended file register	Extended file register file	1	—

\*1 Only FX5U/FX5UC CPU module is supported.

\*2 When the firmware version of the FX5U/FX5UC CPU module is "1.230" or earlier, the maximum number of the files is 60.

## 3.2 Program Capacity Setting

Set to change program capacity.

Only FX5U/FX5UC CPU module is supported. For supported version of program capacity setting, refer to  Page 966 Added and Enhanced Functions.

 Navigation window ⇒ [Parameter] ⇒ [FX5UCPU] ⇒ [CPU Parameter] ⇒ "Program Setting" ⇒ "Program Capacity Setting"

### Window

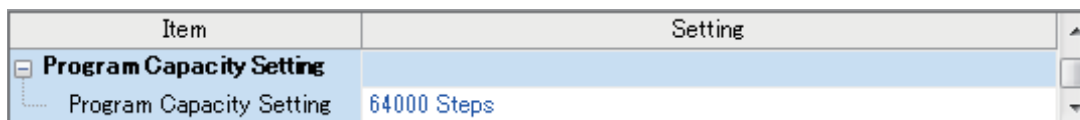

Item	Setting
Program Capacity Setting	64000 Steps

### Displayed items

Item	Description	Setting range	Default
Program Capacity Setting	Set to change program capacity.	<ul style="list-style-type: none"> <li>• 64000 Steps</li> <li>• 128000 Steps</li> </ul>	64000 Steps

### Precautions

If 128000 steps is selected, the operation is changed as follows.

- Signal flow<sup>\*1</sup> area for FB is expanded from 16K bytes to 32K bytes.
- Temporary area capacity is expanded from 700 words to 32767 words.
- Execution time for each instruction is prolonged.

Do not write a program with more than 64000 steps to the CPU module firmware version earlier than "1.100". The program does not operate normally.

\*1 Signal flow: The execution status that the last time an operation of a program or an FB is executed in each step

## 3.3 Files

The CPU module files are explained below.

### File type and storage destination memory

File types and their storage destination memory are explained below.

○: Can be stored, ×: Cannot be stored

File type	CPU built-in memory	SD memory card	File name (extension)
	Data memory		
	Drive No.4	Drive No.2	
Program	○	○	ANY_STRING.PRG
FB files	○	○	ANY_STRING.PFB
CPU parameters	○	○	CPU.PRM
System parameters	○	○	SYSTEM.PRM
Module parameters	○	○	UNIT.PRM
Module extension parameter (for intelligent function module)	○	○	UEXmmmnn.PRM <sup>*2</sup>
Memory card parameter	×	○	MEMCARD.PRM
Device comments	○	○	ANY_STRING.DCM
Device initial values	○	○	ANY_STRING.DID
Event history	○	○	EVENT.LOG
Device data storage file	○	○ <sup>*1</sup>	DEVSTORE.QST
Global label setting file	○	○	GLBLINF.IFG
General-purpose data	×	○	ANY_STRING. (CSV/BIN)
Data logging setting file	○	○	LOGnn.LIS <sup>*3</sup>
Memory dump setting file	○	×	MEMDUMP.DPS
Remote password	○	○	00000001.SYP
Module extension parameter (for protocol setting)	○	○	UEX3FF01.PPR <sup>*4</sup> UEX3FF00.PPR <sup>*5</sup>
Firmware update	×	○	<ul style="list-style-type: none"> <li>■FX5S CPU module</li> <li>• F5Snvvv.SYF<sup>*6</sup></li> <li>■FX5UJ CPU module</li> <li>• F5Jnvvv.SYF<sup>*6</sup></li> <li>■FX5U/FX5UC CPU module</li> <li>• F50nvvv.SYF<sup>*6</sup></li> <li>■Intelligent function module</li> <li>• F5mmvvv.SYF<sup>*7</sup></li> </ul>
Firmware update prohibited	○	○ <sup>*1</sup>	FWUPDP.SYU
System file for backing up CPU module data	×	○	\$BKUP_CPU_INF.BSC
Device/label data file for backing up CPU module data	×	○	BKUP_CPU_DEVLAB.BKD
System file for CPU module auto exchange function	×	○	\$BKUP_CPU_EXCHANGE.DAT
Extended file register file	×	○	EXFILER.ERD
Device station parameter file	○	○	SLAVEmmnnnoooo.NSP <sup>*8,9</sup>
Web server binary file	×	○	F5WebFilexxxxx.HVF <sup>*10</sup>

\*1 Can be stored but cannot operate as a function.

\*2 mmm indicates the module number (3-digit hexadecimal). nn is the serial number (2-digit hexadecimal) for each module.

\*3 nn corresponds to the setting number and is 01 through 04.

\*4 For serial communications file.

\*5 For Ethernet file.

\*6 n is 0 through F.

vvvv is the version information. (4-digit decimal)

\*7 mm is the intelligent function module information.

vvvv is the version information. (4-digit decimal)

\*8 mmm is the module number, nnn is the number of modules, and oooo is the serial number.

\*9 Only FX5U/FX5UC CPU module is supported.

\*10 xxxxxx is the version information.

# Executable file operations

File operations that can be executed on each file are explained below. This operation is possible only when the operation status of the CPU module is the STOP status.

○: Can be executed, —: No corresponding operation

File type	Operation with engineering tool			Operation with FTP server function <sup>*1</sup>			Operation via instruction <sup>*3</sup>	
	Write	Read	Delete	Write <sup>*2</sup>	Read	Delete	Write	Read
Program	○	○	○	○	○	○ <sup>*5</sup>	—	—
FB files	○	○	○	○	○	○ <sup>*5</sup>	—	—
Parameters	○	○	○	○	○	○ <sup>*5</sup>	—	—
Device comments	○	○	○	○	○	○ <sup>*5</sup>	—	—
Device initial values	○	○	○	○	○	○ <sup>*5</sup>	—	—
Global label setting file	○	○	○	○	○	○ <sup>*5</sup>	—	—
Device data storage file	—	—	—	○ <sup>*5</sup>	○	○ <sup>*5</sup>	○	○
General-purpose data	○	○	○	○	○	○	○	○
Data logging setting file	○ <sup>*6</sup>	○ <sup>*6</sup>	○ <sup>*6</sup>	○	○	○	—	—
Memory dump setting file	○	○	○	×	×	×	—	—
Remote password	○	○	○	○	○	○ <sup>*5</sup>	—	—
Firmware update prohibited file	○	○	○	○	○	○	—	—
System file for backing up CPU module data	—	—	—	○	○	○ <sup>*5</sup>	—	—
Device/label data file for backing up CPU module data	—	—	—	○	○	○ <sup>*5</sup>	—	—
System file for CPU module auto exchange function	—	—	—	○	○	○ <sup>*5</sup>	—	—
Extended file register file	○	○	— <sup>*7</sup>	○	○	○ <sup>*5</sup>	○ <sup>*8</sup>	○
Device station parameter file <sup>*4</sup>	○	○	○	○	○	○ <sup>*5</sup>	—	—

\*1 Only files stored on the SD memory card (drive No. 2) are the target.

\*2 Writing is possible when the "Allow Online Change" is set to "Enable" with the FTP server settings.

\*3 Modification of data in files, such as execution of the ERREAD/ERWRITE/ERINIT instruction or SP.FWRITE/SP.FREAD instruction.

\*4 Only FX5U/FX5UC CPU module is supported.

\*5 Available only when the CPU module operation status is STOP. A communication error occurs when operated in the RUN state.

\*6 Operation on CPU Module Logging Configuration Tool.

All the file operation of the target memory unlike memory during data logging execution is possible.

\*7 The extended file registers (ER) can be initialized at once.

\*8 The extended file registers (ER) can be initialized at once by the ERINIT instruction.

# 3.4 Memory Operation

## Initialization and value clear

Each memory can be initialized and cleared to zero by using the engineering tool. For details on the operation method, refer to the following.

 GX Works3 Operating Manual

Items to be specified in the engineering tool		Target
Initialization	Data memory	Deletes all the folders and files in the program memory and data memory.
	SD memory card	Deletes all the folders and files in the SD memory card.
Clear value (when CPU built-in memory is selected)	Device, Label	Zero clear Excluding devices and labels with latch specified, clears the following to zero: X, Y, M, L, B, F, SB, S, T, ST, C, LC, D, W, SW, Z, LZ, R, and all labels (including module labels).
		Zero clear (including Latches (1) and (2)) Including devices and labels with latch specified, clears the following to zero: X, Y, M, L, B, F, SB, S, T, ST, C, LC, D, W, SW, Z, LZ, R, and all labels (including module labels).
Clear value (when SD memory card is selected)		Initializes all extended file registers (ER) with FFFFH.

**Point** 

If the power goes off during initialization or zero clear, the memory is left in the state of that point, and it is necessary to re-execute the memory operation.

### Memory initialization during execution of another function

No memory can be initialized during execution of the following function. Check that the following function is not being executed and then initialize the memory.

- CPU module data backup/restoration function

### Clearing values during execution of another function

#### ■ CPU module data backup/restoration function

During execution of the CPU module data backup/restoration function, devices, labels, and latch areas cannot be cleared to zero. Check that the CPU module data backup/restoration function is not being executed and then clear devices, labels, and latch areas to zero.

# 4 DEVICES

This chapter explains devices.

## 4.1 List of Devices

A list of devices is provided below.

Division	Type	Device name	Symbol	Notation
User device	Bit	Input	X	Octal
	Bit	Output	Y	Octal
	Bit	Internal relay	M	Decimal
	Bit	Latch relay	L	Decimal
	Bit	Link relay	B	Hexadecimal
	Bit	Annunciator	F	Decimal
	Bit	Link special relay	SB	Hexadecimal
	Bit	Step relay	S	Decimal
	Bit/word	Timer	T (Contact: TS, Coil: TC, Current value: TN)	Decimal
	Bit/word	Retentive timer	ST (Contact: STS, Coil: STC, Current value: STN)	Decimal
	Bit/word	Counter	C (Contact: CS, Coil: CC, Current value: CN)	Decimal
	Bit/Double word	Long counter	LC (Contact: LCS, Coil: LCC, Current value: LCN)	Decimal
	Word	Data register	D	Decimal
	Word	Link register	W	Hexadecimal
	Word	Link special register	SW	Hexadecimal
System device	Bit	Special relay	SM	Decimal
	Word	Special register	SD	Decimal
Module access device (U□\G□) <sup>*1</sup>	Word	Module access device	G	Decimal
Index register	Word	Index register	Z	Decimal
	Double word	Long index register	LZ	Decimal
File registers	Word	File registers	R	Decimal
	Word	Extended file register	ER	Decimal
Nesting	—	Nesting	N	Decimal
Pointer	—	Pointer	P	Decimal
	—	Interrupt pointer	I	Decimal
SFC	—	SFC block device	BL	Decimal
	—	SFC transition device	TR	Decimal
Constant	—	Decimal constant	K	Decimal
	—	Hexadecimal constant	H	Hexadecimal
	—	Real constant	E	—
	—	Character string constant	—	—

\*1 The FX5S CPU module is not supported.



Specify code of timer/retentive timer/counter/long counter by T/ST/C/LC if type is determined like instruction when specifying device. If type is not determined, specify by code from among contact, coil or current value according to type. Current value can however also be specified by T/ST/C/LC.

# 4.2 User Devices

This section explains user devices.

## Input (X)

Provides the CPU module with commands and data by external devices such as push buttons, selector switches, limit switches, digital switches, etc.

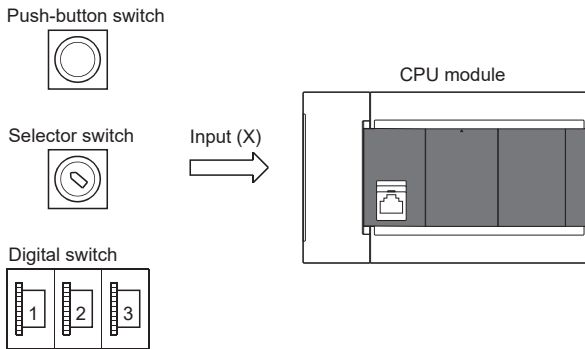

### Concept of input

You can think each input point as having a virtual relay  $X_n$  built into a single CPU module. The program uses NO/NC contact of  $X_n$ .

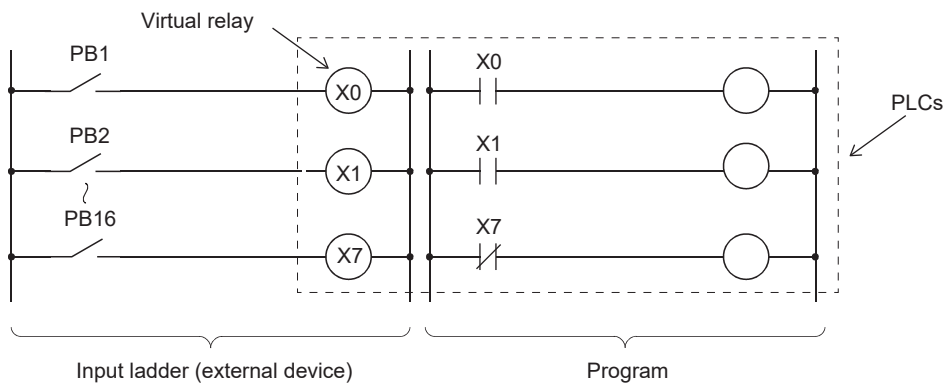

## Output (Y)

Outputs program control results to devices such as external signal lamps, digital indicators, contactors, and solenoids.

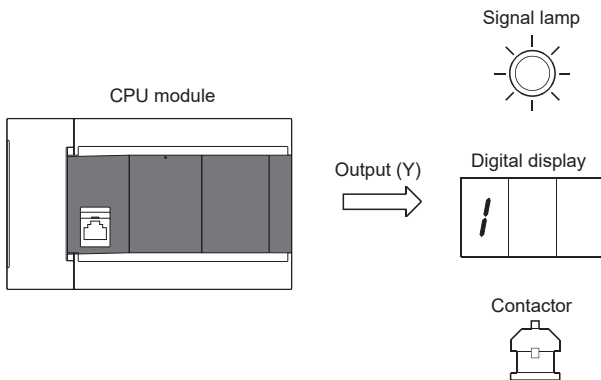



## Internal relay (M)

Device intended to be used as an auxiliary relay inside the CPU module. All internal relays with latch disabled are turned off by the following operation.

- CPU module power OFF→ON
- Reset

All internal relays are turned OFF by the following operation.

- Latch clear

## Latch relay (L)

Auxiliary relay that can latch (backup by battery) in the CPU module. Computation results (ON/OFF information) are latched even when performing the following operations.

- CPU module power OFF→ON
- Reset

## Link relay (B)

Device intended to be used as a CPU side device when refreshing bit data between CPU module and network module.

### Refreshing network module that uses link relay (B)

Sends/receives data mutually between network module link relays (LB) and link relay (B) in the CPU module. Set refresh range by parameters of the network module. Link relays not used for refresh can be used for other purposes.

## Annunciator (F)

Internal relay used for program for detecting equipment errors/faults created by the user. When the annunciator (F) is turned ON, SM62 (Annunciator (F) Detection) turns ON, and the number of annunciator devices that are ON and their numbers are stored from SD62 (Annunciator (F) Detection No.) to SD79 (Annunciator (F) Detection No. Table).

Fault detection program

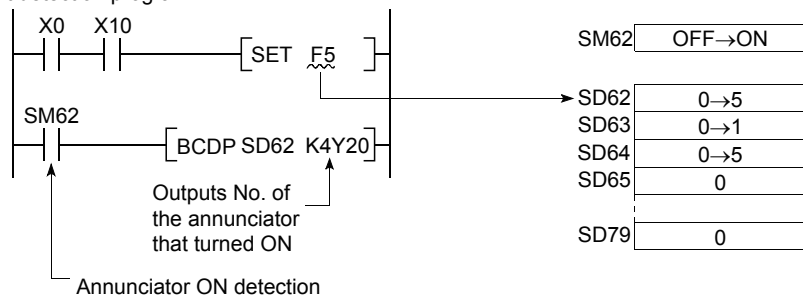

### How to turn annunciator (F) ON

Use SET F□ instruction. The annunciator (F) turns ON only during the rise time of input conditions (OFF→ON); the annunciator (F) remains ON even if the input condition is OFF.

#### Point

- The annunciator (F) can also be turned ON by OUT F□ instruction, but because it is processed every scan, scan time is slower than when using SET F□ instruction.
- If it is turned ON by means other than SET F□ instruction or OUT F□ instruction (e.g. MOV instruction), operation is the same as for internal relay. Thus, in SM62 does not turn ON, and annunciator (F) numbers are not stored in SD62 and SD64 (Annunciator (F) Detection No. table) to SD79.

### ■ Processing when annunciator (F) is ON

Data stored in the special register becomes as follows.

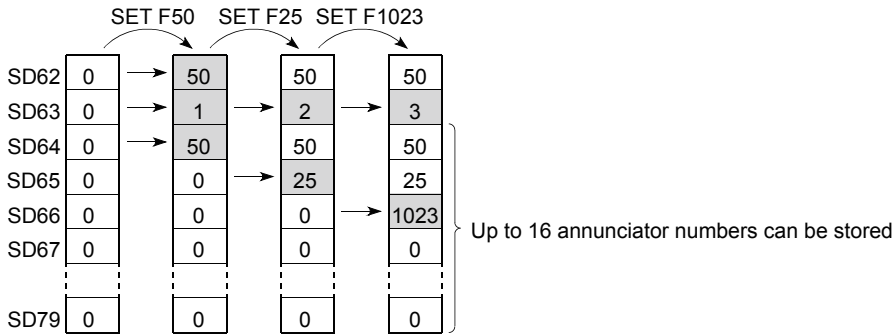

1. Annunciator (F) numbers that are ON are stored in SD64 to SD79 in sequence.
2. Annunciator (F) numbers that are stored in SD64 are stored in SD62.
3. Increments contents of SD63 (Annunciator (F) Detection Number) by +1.

#### Point

If 17 or more annunciators are ON, the numbers are not stored in SD64 to SD79.

### How to turn annunciator (F) OFF

Annunciators (F) are turned OFF by the following instruction.

Instruction	Application
RST F□ instruction	Used to turn OFF annunciator (F) number set by SET F□ instruction.
BKRST instruction	Used to turn a specified range of annunciator (F) numbers OFF in a batch.

#### Point

You can turn OFF by OUT F□ as well, but "Processing when annunciator (F) is OFF" described below is not carried out even if annunciator numbers are turned OFF by OUT F□ instruction. If annunciator (F) numbers are turned OFF by OUT F□ instruction, you must execute the RST F□/BKRST instruction given above.

### ■ Processing when annunciator (F) is OFF

Data stored in the special register becomes as follows.

- Data stored in SD62 to SD79 when RST F□ instruction or BKRST instruction is executed

1. Annunciator (F) numbers specified in the RST F□ instruction or the BKRST instruction are erased, and annunciator (F) numbers stored subsequent to those erased are moved up.
2. If annunciator (F) numbers stored in SD64 are turned OFF, new annunciator (F) numbers stored in SD64 are stored in SD62.
3. Decrements contents of SD63 by -1. If SD63 is "0", SM62 is turned OFF.

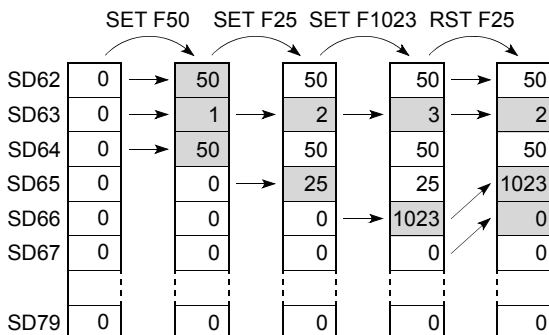

## Link special relay (SB)

Communication and error detection status of network modules are output to link special relays within the network. Link special relays (SB) are devices intended to be used as a refresh destination for link special relays within the network. Link special relays not used for refresh can be used for other purposes.

## Step relay (S)

Device to perform process stepping control. Purposes are as follows. Device which is not used can be used for purposes such as auxiliary relay.

- Step ladder (MELSEC iQ-F FX5 Programming Manual (Instructions, Standard Functions/Function Blocks))
- SFC program (MELSEC iQ-F FX5 Programming Manual (Program Design))
- Specifies a step.
- SFC control instruction
- Specifies a step No. to check the SFC program (monitor and change of the current value) by the engineering tool.

## Timer (T/ST)

Device whereby measurement starts when the timer coil is turned ON, time up occurs when current value reaches the setting value, and the contact is turned ON. The timer is an addition type counter. When time is up, the current value and setting value are the same value.

### Types of timers

There are timers (T) for which current value is maintained in 16 bits, and retentive timers (ST) that maintain the current value even when the coil is turned off.\* 1

\*1 Current value of timers (T) becomes "0" when the coil is turned OFF.

#### ■Timer (T)

Measurement starts when the timer's coil is turned ON. Time up occurs when the current value of the timer matches the setting value and the timer's contact is turned ON. When the timer's coil is turned OFF, the current value becomes "0" and the timer's contact is turned OFF.

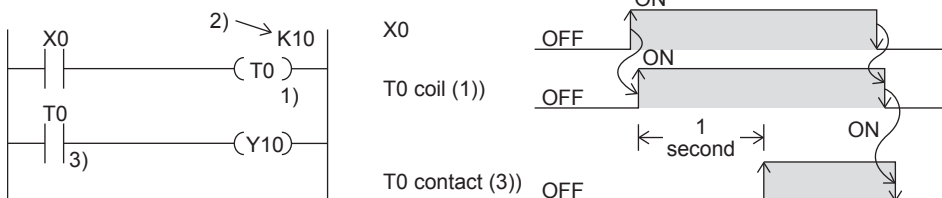

## ■Retentive timer (ST)

Measures time for which the coil is ON. Measurement starts when the retentive timer's coil is turned ON, and when the current value matches the setting value (time up), the retentive timer's contact is turned ON. The current value and ON/OFF status of the contact are maintained even if the retentive timer's coil is turned OFF. When the coil is turned back ON, measurement resumes from the current value maintained. The current value is cleared and the retentive timer is turned OFF by the RST ST□ instruction.

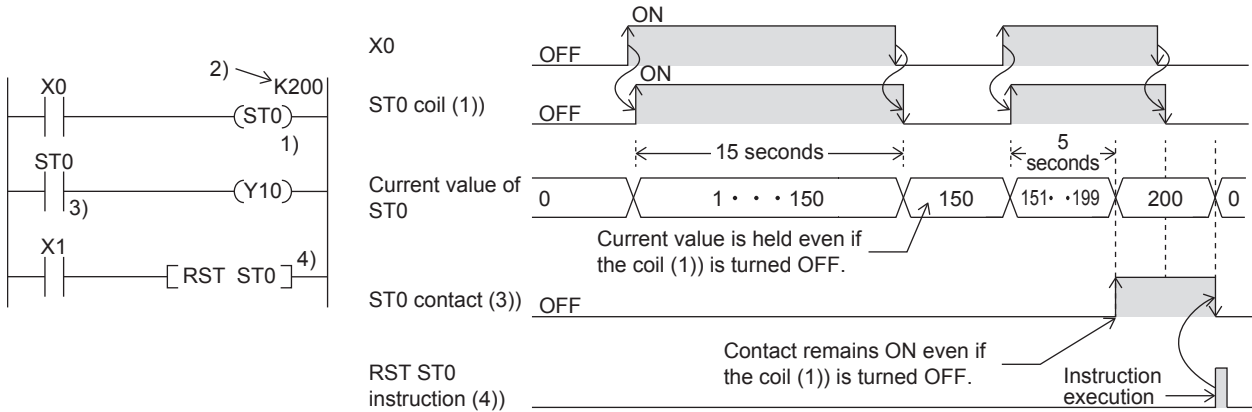

## ■Low-speed timer/Timer/High-speed timer (T/ST)

Low-speed timers, timers and high-speed timers are the same device. The timer is specified (by instruction) as a low-speed timer, timer, or high-speed timer. If for example, you specify "OUT T0," the timer is a low-speed timer (100 ms); if you specify "OUTH T0," it is a timer (10 ms); if you specify "OUTHHS T0," it is a high-speed timer (1 ms). The same goes for retentive timers.

## ■Routine timer (T)

The routine timer is a timer (100ms) that can operate even with a program that is not necessarily executed with every scan. Eight timers can be used at the maximum. This timer counts when the OUT T□ instruction, the ANS instruction, or the END instruction is executed.

To use a routine timer, it is necessary to set the parameter. (☞ Page 60 Routine timer setting)

## Current value and measurement range of timer

### ■Timer

The current value range is 0 to 32767.

### Timer processing method

The timer's coil is turned ON/OFF, the current value is updated and the contact is turned ON/OFF when timer's coil (OUT T□ instruction) is executed.

## Details on timer operation and timer accuracy

A timer (T/ST) starts counting when a coil is driven, and its output contact turns on when the first coil instruction is executed after the timer has reached timeout.

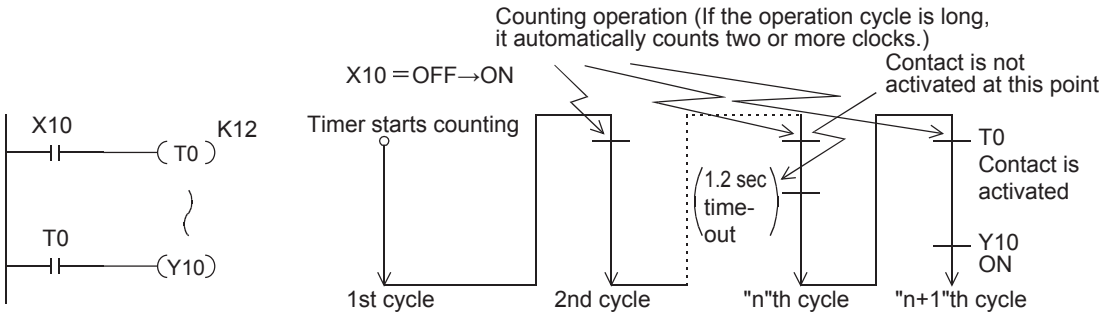

As shown in the above operation diagram, the accuracy of operation of the timer contact after the coil is driven until the contact turns on is shown in the following outline:

$$T \begin{matrix} +T_0 \\ -\alpha \end{matrix}$$

T : Timer set value (sec)  
 T<sub>0</sub> : Operation cycle (sec)  
 α : 0.001 sec (timer for 1 ms), 0.01 sec (timer for 10 ms) or 0.1 sec (timer for 100 ms)

If the contact is programmed before the timer coil, "+2T<sub>0</sub>" is obtained in the worst case.

When the timer set value is "0", the output contact turns on when a coil instruction is executed in the next cycle.

Setting the timer to a small value increases the variability of the time taken for the timer contact to activate. If such a case causes a problem, please consider using the high-speed timer.

## The difference between a timer and a routine timer

Described below is the difference between a timer and a routine timer.

Item	Timer	Routine timer
Resolution	100 ms/10 ms /1 ms	100 ms
The timing of counting (count up)	When the OUT T□ instruction or the ANS instruction is executed	<ul style="list-style-type: none"> <li>When the OUT T instruction or the ANS instruction is executed</li> <li>If the OUT T instruction or the ANS instruction is not executed, the counting starts when the END instruction is executed.</li> </ul>
The timing of time up (the operation at the output contact)	When the OUT T□ instruction or the ANS instruction is executed	<ul style="list-style-type: none"> <li>When the OUT T instruction or the ANS instruction is executed</li> <li>When the END instruction is executed</li> </ul>
Device	T, ST	T

## Precautions when using timers

Precautions when using timers are as follows.

- Do not specify the same timer coil (OUT T□ instruction) more than once per scan. If you do, the current value of the timer is updated when each respective timer coil is executed, so measurement cannot be performed normally.
- When timer is not used for data collection for each scan: While the coil on a timer (e.g. T1) is turned on, the timer coil (the OUT T□ instruction) cannot be skipped by the instructions such as the CJ. If a timer's coil is skipped, the timer's current value is not updated, so measurement cannot be performed normally. In addition, when the timer exists in a subroutine program, be sure to execute a subroutine call including T1 coil only once for each scanning operation while the coil of the timer (e.g. T1) is turned on. If not executed, measurement cannot be performed normally.
- The timer cannot be used in the initial execution type program, fixed scan execution type program, or event execution type program. The timer can be used in standby type programs if the coil of timer (OUT T□ instruction) is executed one time for one scan using a subroutine program.
- The timer cannot be used in interrupt programs. The timer can be used in subroutine programs or FB programs if the coil of timer (OUT T□ instruction) is executed one time for one scan.
- If setting value is "0": The output contact operates when the coil instruction of the next cycle is executed.
- If setting value is modified after time up: The timer remains in time up status and does not operate even if the setting value is raised higher than the current value after time up.

## Routine timer setting

The setting of the routine timer is made.

Navigation window ⇒ [Parameter] ⇒ [Module model name] ⇒ [CPU Parameter] ⇒ "Memory/Device Setting" ⇒ "Device/Label Memory Area Setting"

### Window

Item	Setting
Device/Label Memory Area Detailed Setting	
Device (high speed) Setting	<Detailed Setting>
Device (Standard) Setting	<Detailed Setting>
Latch type setting of the latch relay (L)	Latch (1)
Latch Label Latch Type	Latch (1)
Latch area of the latch label	Standard Latch Area
To use or not to use the routine timer of timer (T)	Not Use
Start device No. of routine timer of timer (T)	0

### Displayed items

Item	Description	Setting range	Default
To use or not to use the routine timer of timer (T)	Whether the routine timer is used is set.	<ul style="list-style-type: none"><li>• Not use</li><li>• Use</li></ul>	Not use
Start device No. of routine timer of timer (T)	The initial device of the routine timer is set.	<ul style="list-style-type: none"><li>■FX5S/FX5U/FX5UC CPU module</li><li>• 0 to 511</li><li>■FX5U/FX5UC CPU module</li><li>• 0 to 1023</li></ul>	0

## Counter (C/LC)

Device that counts number of rises of input conditions in the program. Counters are addition type counters; they count up when the count value matches the setting value, and the contact is turned ON.

For FX3-compatible high-speed counters, refer to Page 288 FX3-compatible High-speed Counter Function.

### Counter type

There is counter (C) that maintains the counter value in 16 bits and the long counter (LC) that maintains the counter value in 32 bits. Counter (C) and long counter (LC) are separate devices. You can set number of device points for each. However, for FX5UJ CPU module, the number of device points is fixed.

#### ■Counter (C)

Uses 1 word as 1 point. The counting range is from 0 to 65535.

#### ■Long counter (LC)

Uses 2 words as 1 point. The counting range is from 0 to 4294967295.

## Count processing

Count processing is as follows when counter's coil is executed.

### ■When the OUT C□ instruction/OUT LC□ instruction is executed

The counter's coil is turned ON/OFF, the current value is updated (count value +1) and contact ON/OFF processing is executed.

### ■Current value update (count value +1)

Current value is updated (count value +1) when counter coil input rises (OFF→ON). Current value is not updated when coil input is OFF, ON, or turned ON→OFF.

[Ladder example]



[Current value update timing]

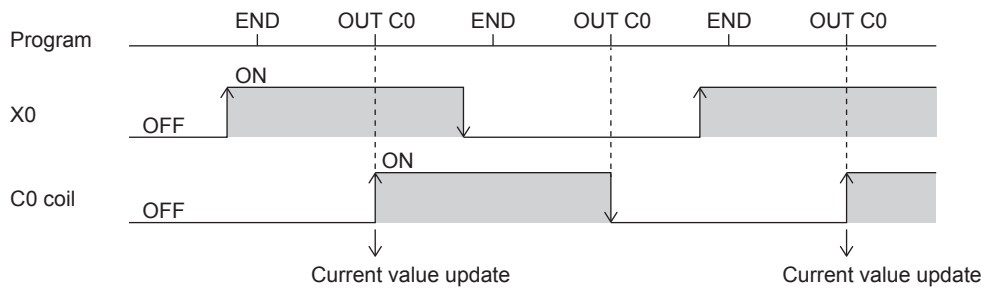

## Counter reset

Current value of counters is not cleared even if its coil input is turned OFF. To clear (reset) the current value of the counter and turn the contact OFF, use the RST C□ instruction/RST LC□ instruction. The counter value is cleared and the contact is turned OFF as soon as the RST C□ instruction is executed.

[Ladder example]

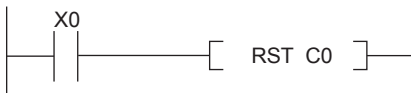

[Counter reset timing]

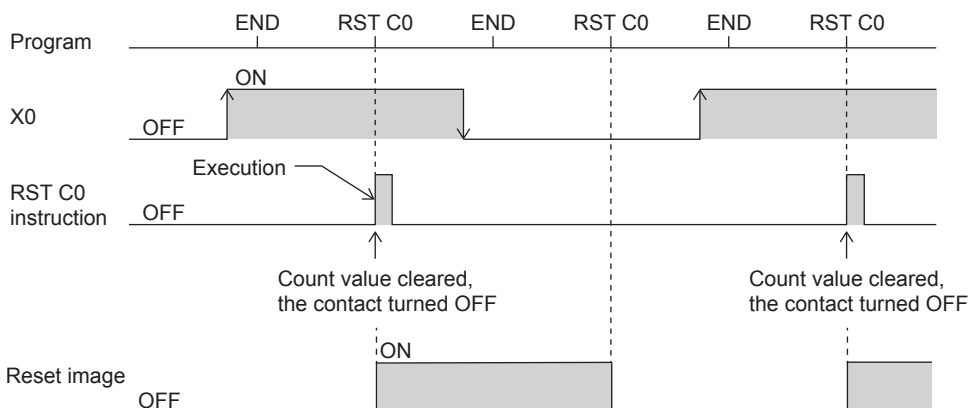

## Precautions when performing counter reset

- When a counter is reset by the RST instruction, it cannot count until the RST instruction is set to OFF.

[Program example]

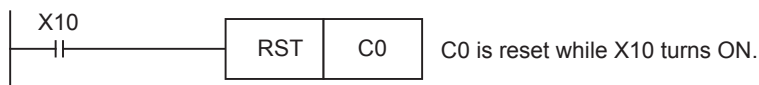

[Timing chart]

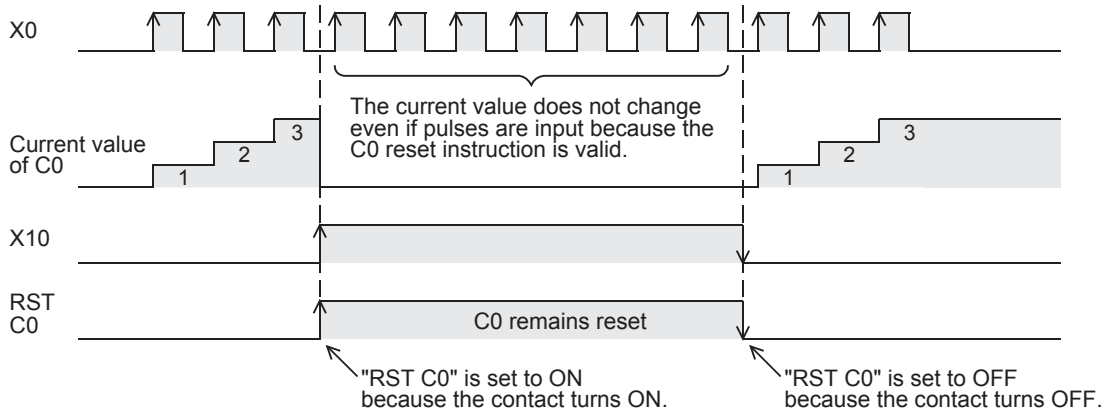

- When the counter is set as a latch device, the current value of a counter, output contact operation, and the reset image are latched.
- If the ZRST instruction is used, the RST image of a counter is reset.

## Data register (D)

Device capable of storing numerical data.

## Link register (W)

Device intended to be used as a CPU side device when refreshing word data between CPU module and network module.

### Refreshing network module that uses link register (W)

Sends/receives data mutually between link registers (LW) in network module and link register (W) in the CPU module. Set refresh range by parameters of the network module. Link registers not used for refresh can be used for other purposes.

## Link special register (SW)

Word data such as communication and error detection status information of network modules is output to link special relays within the network. Link special registers (SW) are devices intended to be used as a refresh destination for link special registers within the network. Link special registers not used for refresh can be used for other purposes.

## 4.3 System Devices

System devices are devices for the system. Assignment/capacity are fixed and cannot be changed by the user.

### Special relay (SM)

The PLC contains internal relays with fixed specifications, so it cannot be used in the program like a conventional internal relay. It can however be turned ON/OFF to control the CPU module as needed. (Page 772 Special Relay List)



## Special register (SD)

The PLC contains internal register with fixed specifications, so it cannot be used in the program like a conventional internal register. Data, however, can be written to control the CPU module as needed. (  Page 799 Special Register List)

## 4.4 Module Access Device

Device that allows you to directly access the buffer memory of intelligent function modules connected to the CPU module from the CPU module.

The FX5S CPU module is not supported.

### Specification method

Specified by U [module number of intelligent function modules]\[buffer memory address].

(Example: U5\G11)

### Processing speed

Processing speed of reading/writing by module access device is faster than using FROM/TO instruction. (Example: MOV U2\G11 D0) When reading the buffer memory of a module access device and executing another process by 1 instruction, the processing speed would be approximately the total of processing speed of FROM/TO instruction and processing speed of instruction. (Example: +U2\G11 D0 D10)

#### Point

If reading/writing data of the buffer memory using module access device at least 2 times in the program, you can speed up processing time by reading/writing at a single place in the program using a FROM/TO instruction.

- Writing using multiple module access devices

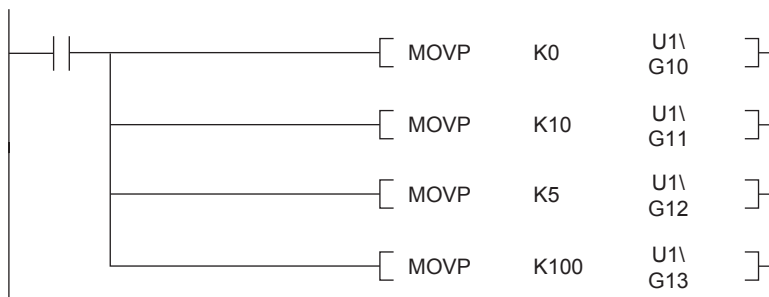

- Writing at single place in program using TO instruction

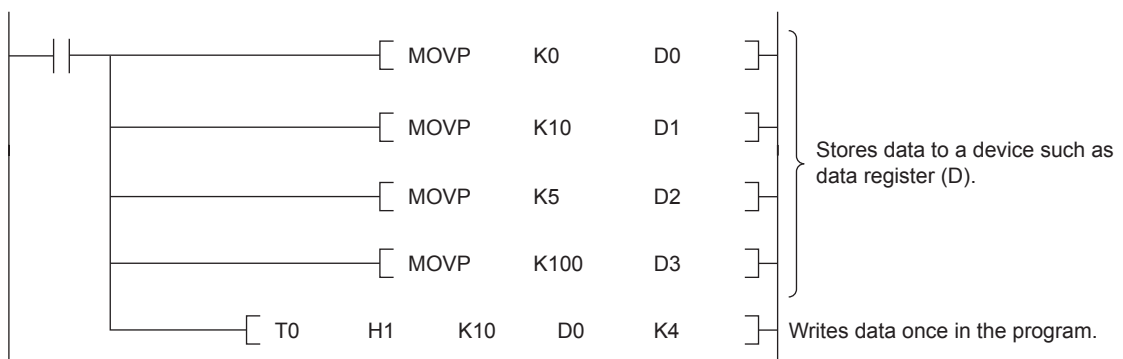

## Precautions

- If module access device is used in an interrupt program with the priority 1, operation error (3580H) occurs. Module access device operates in an interrupt program with the priority 2 or 3.
- When FROM/TO instruction is executed in an interrupt program to an FX3 intelligent function module that is connected to the bus conversion module or later, operation error (3580H) occurs.

# 4.5 Index Register (Z/LZ)

Device used for indexing of devices.

## Types of index registers

There are 2 types: the index register (Z) and long index register (LZ)

### Index register (Z)

Used for 16-bit index modification.

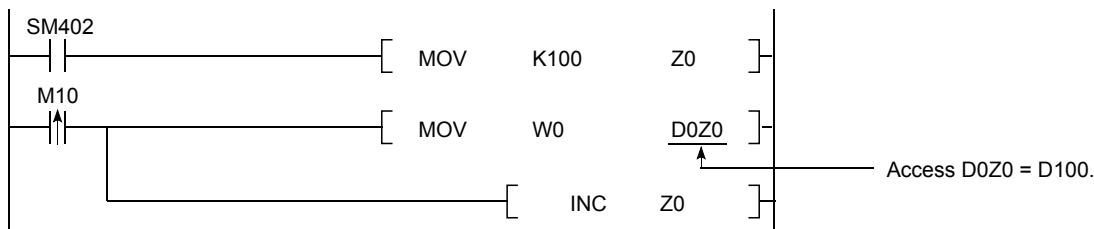

### Long index register (LZ)

Used for 32-bit index modification.

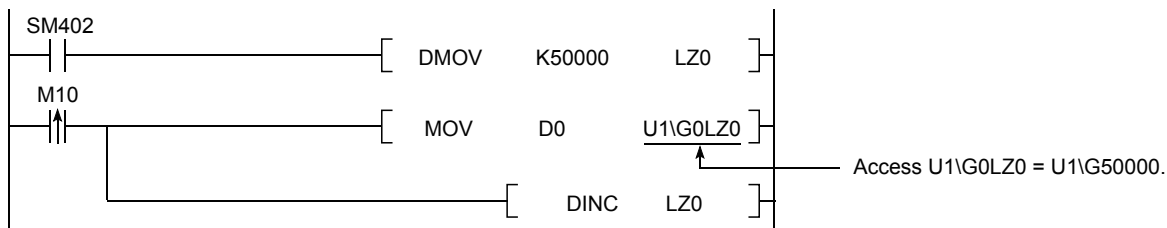

## Device for which index modification can be performed

The following table lists the devices that can be targeted for index modification.

Item	Description
Index modification by the index register (Z)	All devices
Index modification by the long index register (LZ)	U□\G, K, H

## Index register setting

A total of 24 words can be used for index register (Z) and long index register (LZ). The FX5S/FX5U/FX5UC CPU modules can change the number of points by parameter.

Navigation window ⇒ [Parameter] ⇒ [Module model name] ⇒ [CPU Parameter] ⇒ "Memory/Device Setting" ⇒ "Index Register Setting"

### Window

Item	Setting
Index Register Setting	
Points Setting	
Total Points	24 Word
Index Register (Z)	20 Points
Long Index Register (LZ)	2 Points

### Displayed items

Item	Description	Setting range	Default
Total Points	Show the total number of points for index register and long index register.	—	—
Index Register (Z)	Set the number of points for index registers.	■FX5S/FX5U/FX5UC CPU module • 0 to 24 points (2 point unit) ■FX5UJ CPU module • 20 points (fixed)	20 points
Long Index Register (LZ)	Set the number of points for long index registers.	■FX5S/FX5U/FX5UC CPU module • 0 to 12 points (1 point unit) ■FX5UJ CPU module • 2 points (fixed)	2 points

## 4.6 File Register (R/ER)

Device capable of storing numerical data.

### Types of file register

There are 2 types: the file register (R) and extended file register (ER)

#### File register (R)

The device held in the CPU built-in memory.

#### Extended file register (ER)

The device held only in the SD memory card. The extended file register (ER) function can be used with the programs (dedicated instructions) or GX Works3.

#### Point

- For supported version of extended file register (ER), refer to  Page 966 Added and Enhanced Functions.
- Extended file register (ER) can be used only when the SD memory card is inserted to the CPU module.

## Extended file register (ER) function

### Function to use the program (dedicated instructions)

Extended file register (ER) functions that can be used by applied instructions are shown below.

- ERREAD instruction: Reading function of extended file register (ER)
- ERWRITE instruction: Writing (transfer) function of extended file register (ER)
- ERINIT instruction: Batch initialization function of extended file register (ER)

For each applied instruction, refer to  MELSEC iQ-F FX5 Programming Manual (Instructions, Standard Functions/Function Blocks).

#### Point

Extended file register (ER) function is not applicable to the file register (R) stored into the SD memory card by the memory dump function.

### ■ Reading function of extended file register (ER)

The current value of the extended file register (ER) stored into the SD memory card can be read from the file register (R) in the CPU built-in memory by using ERREAD instruction.

The device number of data transfer source and data transfer destination is the same number. (When ER0 to 100 are read, the values are stored to R0 to 100.) In using the ERREAD instruction, the maximum number of device points which can be read from the extended file register (ER) is 32768.

### ■ Writing (transfer) function of extended file register (ER)

The current value of the file register (R) in the CPU built-in memory can be written (transferred) to the extended file register (ER) in the SD memory card by using ERWRITE instruction.

The device number of data transfer source and data transfer destination is the same number. (When R0 to 100 are written, the values are stored to ER0 to 100.) In using the ERWRITE instruction, the maximum number of device points which can be written to the extended file register (ER) is 32768.

### ■ Batch initialization function of extended file register (ER)

All the points of the extended file register (ER) in the SD memory card can be initialized in a batch by using ERINIT instruction.

If all the points of the file register (R) in the CPU built-in memory are initialized, you must write K0 by FMOV instruction, etc.

### Function to use the GX Works3

Extended file register (ER) functions that can be used by GX Works3 are shown below.

- Data batch reading function
- Data batch writing function
- Data batch initialization (clearing values) function
- Data batch initialization (memory initialization) function

For operation of GX Works3, refer to  GX Works3 Operating Manual.

#### Point

- Extended file register (ER) function by GX Works3 cannot specify the target device points; instead, all of the device points become the target.
- The device memory in the project of GX Works3, and the file register (R) in the CPU built-in memory and SD memory card will not be updated by these functions.

## ■Data batch reading function

All the current values of the extended file register (ER) stored into the SD memory card can be read from the device memory in the project of GX Works3 (extended file register (ER)) in a batch.

 [Online] ⇨ [Read from PLC]

### Window

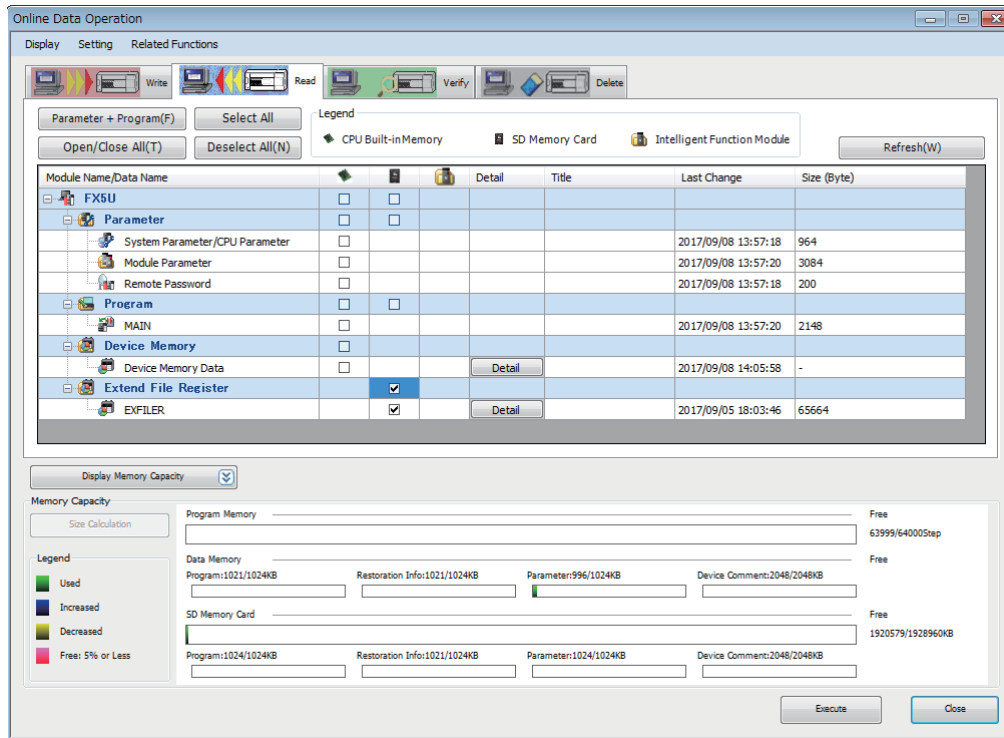

Check the "Extended File Register" box under SD memory card, execute read, and the current value of the extended file register (ER) in the SD memory card will be stored to the device memory in the project of GX Works3 (extended file register (ER)).

All the points (32768 points) of the extended file register (ER) in the SD memory card are read from the device memory in the project of GX Works3 without depending on the user's device point setting of the file register (R). ( Page 81 Device Setting)

## ■Data batch writing function

All the value registered to the device memory in the project of GX Works3 (extended file register (ER)) can be written to the extended file register (ER) in the SD memory card in a batch.

 [Online] ⇄ [Write to PLC]

### Window

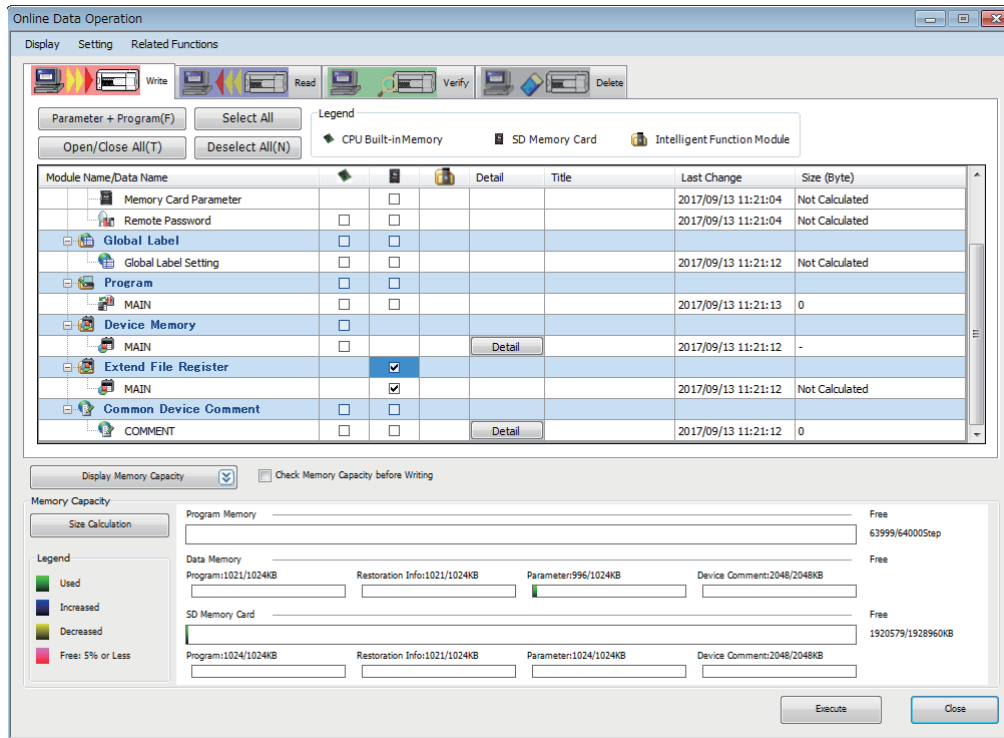

Check the "Extended File Register" box under SD memory card, execute write, and the value of the device memory in the project of GX Works3 (extended file register (ER)) will be stored to the extended file register (ER) in the SD memory card. All the points (32768 points) of the device memory in the project of GX Works3 are written to the extended file register (ER) in the SD memory card without depending on the user's device point setting of the file register (R). ( Page 81 Device Setting)

### ■Data batch initialization (clearing values) function

All of the extended file register (ER) in the SD memory card can be cleared from GX Works3 in a batch.

 [Online] ⇒ [CPU Memory Operation]

#### Window

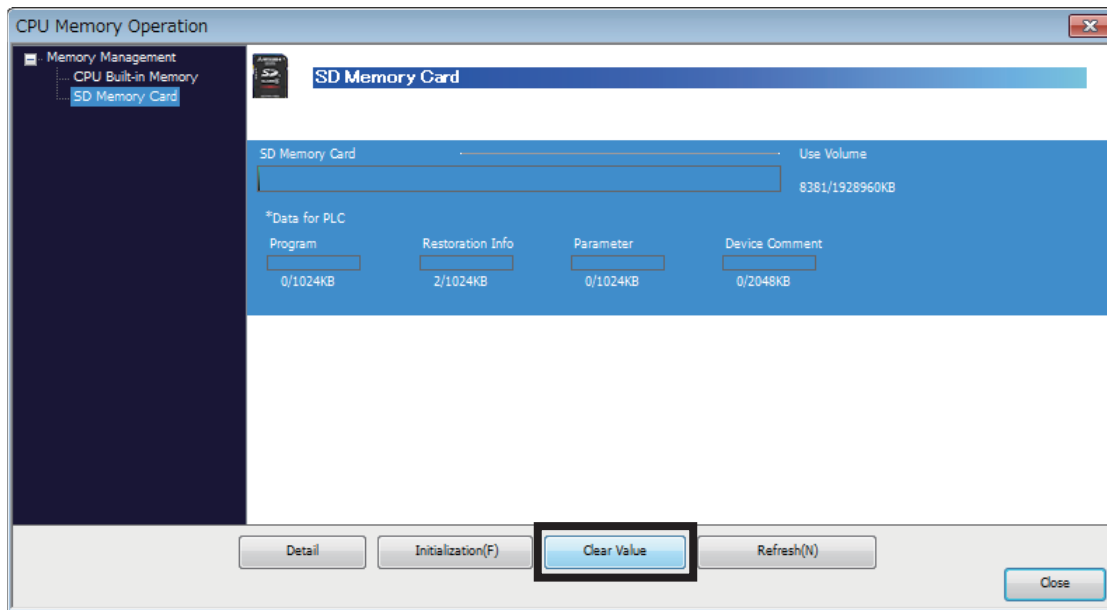

Switch the screen to the memory operation screen of the SD memory card, select [Clear Value], and the extended file register (ER) in the SD memory card is initialized.

### ■Data batch initialization (memory initialization) function

The extended file register (ER) in the SD memory card can be initialized (formatted) from GX Works3. However, in addition to the extended file register (ER), all of the folders and files in the SD memory card are formatted.

 [Online] ⇒ [CPU Memory Operation]

#### Window

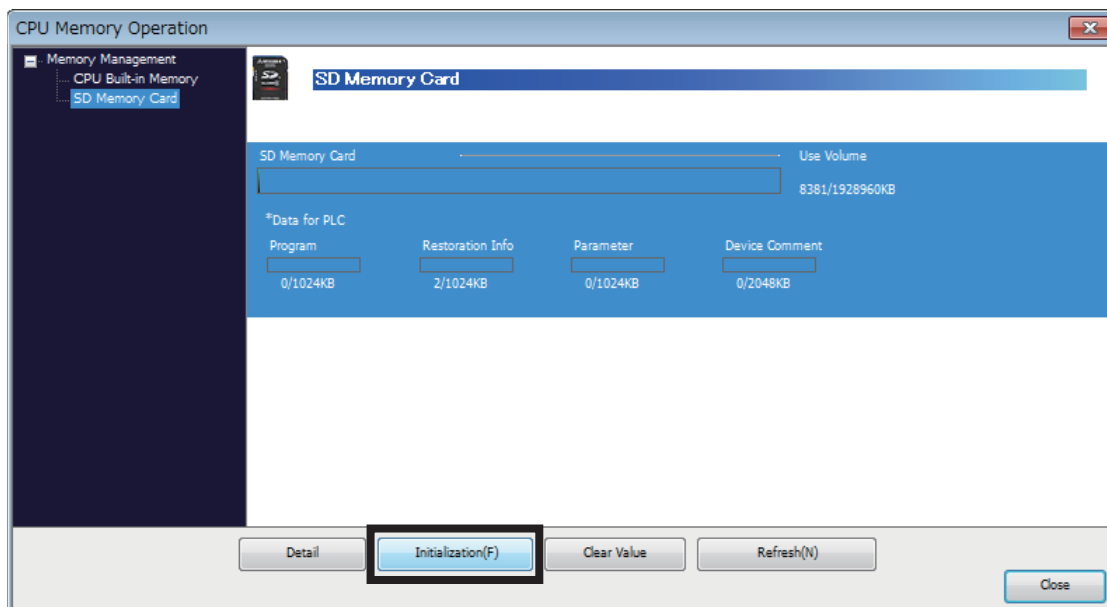

Switch the screen to the memory operation screen of the SD memory card, select [Initialization], and all of the data in the SD memory card including the extended file register (ER) is initialized.

## 4.7 Nesting (N)

Device for programming operating conditions by nesting using master control instructions (MC/MCR instruction)<sup>\*1</sup>. Operation conditions are specified in ascending order (N0 to N14) from outside the nesting.

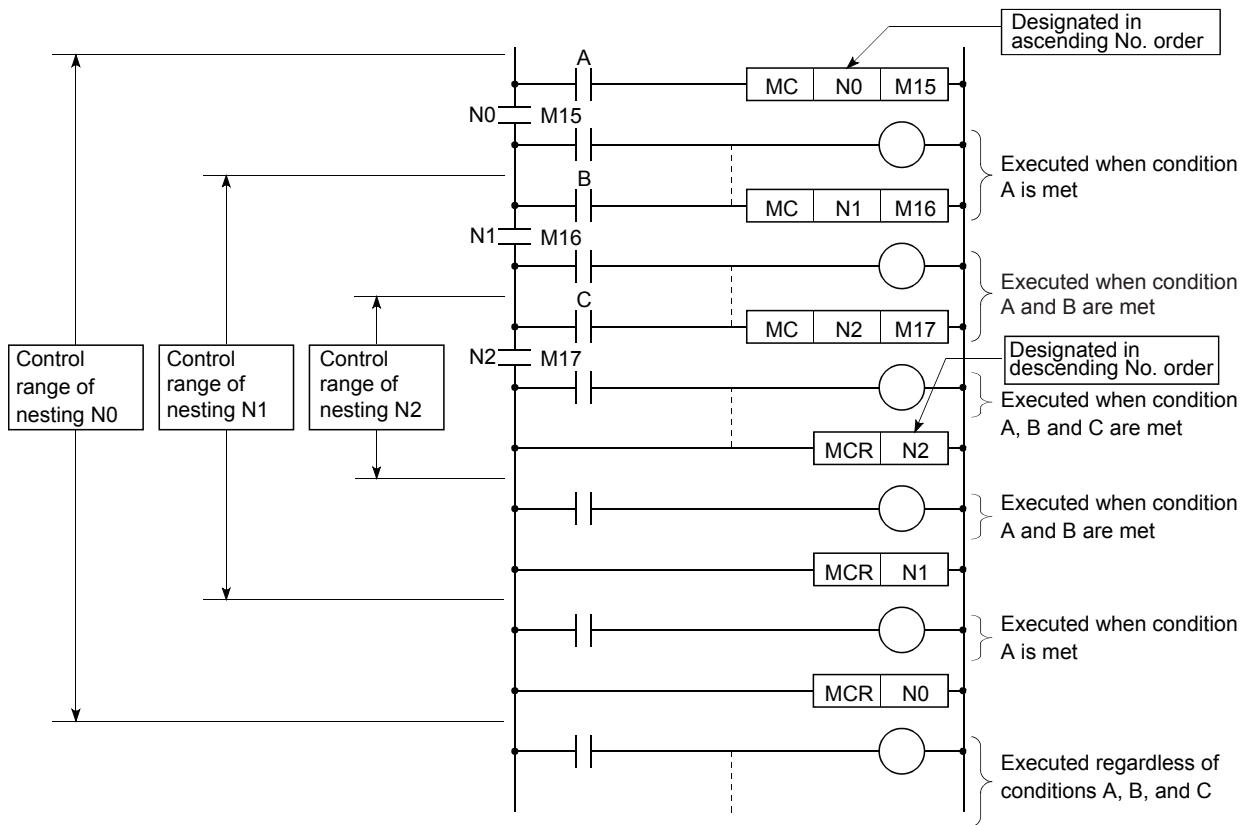

\*1 Instruction for creating an efficient circuit switching program by switching common bus of the circuit.

## 4.8 Pointer (P)

Device used by instructions such as jump instruction (CJ instruction) and subroutine program call instruction (CALL instruction, etc.). Types of pointers are as follows.

Pointer	Description
Global pointers	Pointers that can be referred to from all programs.
Label assignment pointers	Pointers used by assignment to labels. Pointer numbers assigned to labels are automatically determined by engineering tool; the user cannot specify pointer numbers to be assigned.

Pointers are used for the following purposes.

- Specifies label and where to jump to for jump instruction (CJ instruction).
- Specifies label (top of subroutine program) and call destination of subroutine instruction (CALL instruction, etc.).



# Global pointers

Pointer for calling subroutine from all programs being run.

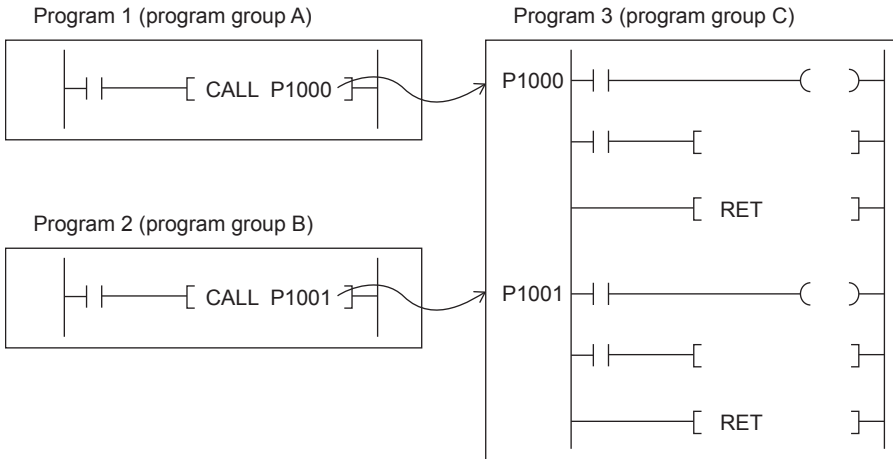

## Precautions when using global pointers

- A global pointer of the same pointer number cannot be set as a label for more than one location.
- The initial pointer number for global pointers is fixed to "0".

## Label assignment pointers

Pointer assigned to pointer type labels. Pointer for label assignment are automatically assigned to pointer type labels by engineering tool. Pointer numbers of pointers for label assignment cannot be directly specified. By defining pointer type labels, you can specify destination for jump instruction or subroutine program by label instead of pointer such as P0.

# 4.9 Interrupt Pointer (I)

Device used as label at top of interrupt program. Can be used by all running programs.

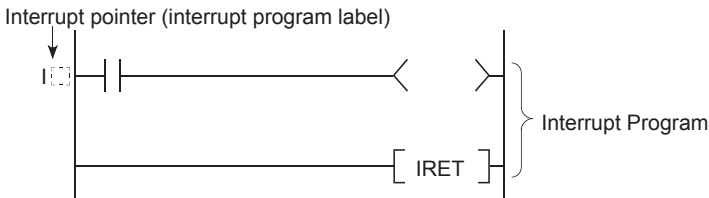

### Point

- Setting the execution type of program to the event execution type eliminates the need to write (I□) the interrupt pointer. (☞ Page 35 Generation of interrupt by interrupt pointer (I))
- If the interrupt pointer numbers are I0 to I15 and a pattern program is created at the beginning of the program, it operates as an input interrupt delay function. (☞ Page 111 Input Interrupt Delay Function)

## Interrupt causes of the interrupt pointer numbers

A list of interrupts is provided below.

Interrupt	Interrupt pointer number	Description
Input interrupt	I0 to I15	Interrupt pointer used for input interrupt of CPU module (with/without delay). Up to 8 points can be used.
High-speed comparison match interrupt	I16 to I23	Interrupt pointer used for high-speed comparison match interrupt of CPU module.
Interrupt by internal timer	I28 to I31	Interrupt pointer used for fixed cycle interrupt by internal timer.
Interrupt from module	I50 to I177	Interrupt pointer used for a module that has interrupt function.

## The priority for the interrupt pointer numbers and interrupt factors

The priority for the interrupt pointer numbers and interrupt factors are indicated.

Interrupt pointer number	Interruption cause	Interrupt priority	Interrupt priority order	Remarks
I0	Input interrupt (Input terminal: X0 to X17)	1 to 3	1	<ul style="list-style-type: none"> <li>The default value for priority is "2".</li> <li>X0 to X17 are assigned as I0 to I15.</li> <li>The priority of the input interrupt delay function is 2 to 3. If 1 is set, it operates without delay time.</li> </ul>
I1			2	
I2			3	
I3			4	
I4			5	
I5			6	
I6			7	
I7			8	
I8			9	
I9			10	
I10			11	
I11			12	
I12			13	
I13			14	
I14			15	
I15			16	
I16	High-speed comparison match interrupt	1 to 3	17	The default value for priority is "2".
I17			18	
I18			19	
I19			20	
I20			21	
I21			22	
I22			23	
I23			24	
I28	Interrupt by internal timer	1 to 3	28	The default value for priority is "2".
I29			27	
I30			26	
I31			25	
I50 to I177	Interrupt from module	2 to 3	29 to 156	<ul style="list-style-type: none"> <li>The default value for priority is "2".</li> <li>The highest priority rank is I50 and the lowest is I177.</li> </ul>

### Point

- The interrupt priority is the order which is executed at the time of the multiple interrupt. The lower the numerical value, the higher the interrupt priority.
- The interrupt priority order is the order which is executed when the interrupt factor with the same interrupt priority is generated.

## 4.10 SFC Devices

These are the devices used by the SFC function.

### SFC block device (BL)

This device is used when specifying SFC program blocks. This device is also used when specifying step No. through such methods as verifying (monitor, current value changes) SFC programs with SFC control instructions or the engineering tool.

( MELSEC iQ-F FX5 Programming Manual (Program Design))

#### Point

To start the SFC block device for the SFC program while ON/OFF information of the SFC block device (BL) are maintained (continuation start), an option battery is required.

4

### SFC transition device (TR)

This device is used when specifying SFC program transition conditions. This device can only be used for device comments for transition conditions. ( MELSEC iQ-F FX5 Programming Manual (Program Design))

## 4.11 Indirect Specification

Specify the device using the indirect address of device. Store the indirect address of device to be specified into the device for indirect specification, and write as "@ + Device for indirect specification".

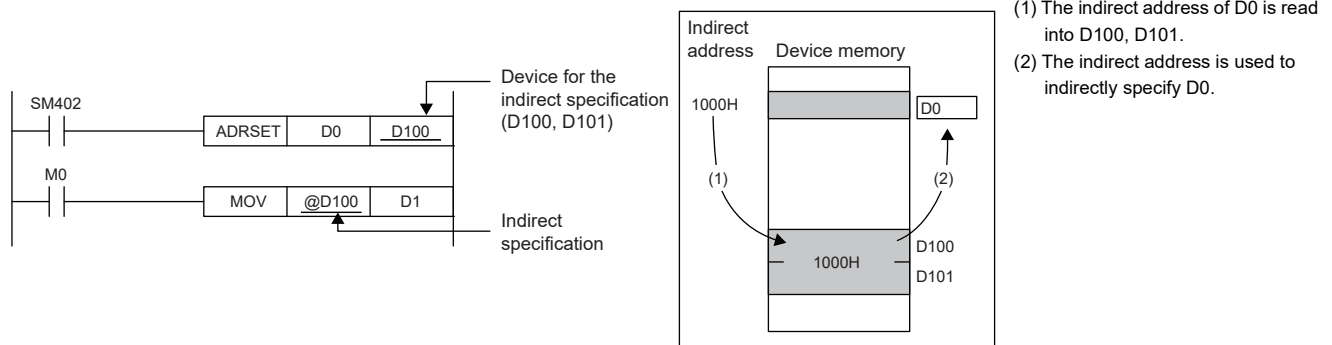

- (1) The indirect address of D0 is read into D100, D101.
- (2) The indirect address is used to indirectly specify D0.

The indirect specification can be used in the device/label memory.

### Indirect address of device

To specify, use the 32-bit data, and to hold the value, use the device of two words. The indirect address of the device can be obtained with the ADRSET instruction. The ADRSET instruction specifies the indirect address of the device using instructions that handle 32-bit data. For the ADRSET instruction, refer to the following.

( MELSEC iQ-F FX5 Programming Manual (Instructions, Standard Functions/Function Blocks))

### Devices that can allow indirect specification

This section lists devices that can allow indirect specification.

Type	Device <sup>*1</sup>
Devices that can allow indirect specification where @ is added	D, W, SW, SD, U□V, R
Device that can acquire the indirect address through the ADRSET instruction	D, W, SW, SD, R

\*1 Devices that cannot be used as operands of instructions cannot be used even when they are indirectly specified.

# 4.12 Constant

This section explains constants.

## Decimal constant (K)

Device that specifies decimal data for the program. Specified by K□. (e.g. K1234).

The specification range is determined by type of argument data of instruction using a decimal constant.

Argument data type of instruction		Specification range of decimal constants
Data size	Data type name	
16 bits	Word (signed)	K-32768 to K32767
	Word (unsigned)/Bit string (16-bit)	K0 to K65535
32 bits	Double word (signed)	K-2147483648 to K2147483647
	Double word (unsigned)/Bit string (32-bit)	K0 to K4294967295

## Hexadecimal constant (H)

Device that specifies hexadecimal data for the program. Specified by H□. (e.g. H1234)

When specifying BCD data, specify each digit of hexadecimal number in 0 to 9. The specification range is determined by type of argument data of instruction using a hexadecimal constant. If data size is 16 bits, H0 to HFFFF; if 32 bits, H0 to HFFFFFFFF.

## Real constant (E)

Device that specifies real numbers for the program. Specified by E□. (e.g. E1.234)

### Setting range of real numbers

The setting range of real numbers is explained below.

$$-2^{128} \leq \text{Device} \leq -2^{-126}, 0, 2^{-126} \leq \text{Device} \leq 2^{128}$$

(E-3.40282347+38 to E-1.17549435-38, 0, E1.17549435-38 to E3.40282347+38)

### Operation during calculation

#### ■ Operation at overflow and underflow

Operation is as follows if overflow or underflow occurs during calculation.

- When overflow occurs: An error is returned.
- When underflow occurs: 0 is returned (no error occurs).

#### ■ Operation when special value\*1 is input

If calculation is performed when input data is a special value, an error occurs. If "-0" occurs during calculation, it is treated as "+0"; the calculation result does not become "-0".

\*1 Special values are -0, denormalized numbers, non-numbers, ±∞.

### Programming expressions

Real numbers can be specified by the following expressions.

- Normal expression: Specify a numeric value as is. (Example: E10.2345 in the case of 10.2345)
- Scientific notation: Specify a numeric value in the format "numeric value" ×10<sup>n</sup>. (Example: E1.234+3 in the case of 1234. "+3" represents "10<sup>3</sup>".)

# Character string constant

The character string can be specified by enclosing it with single quotation marks ( ' ') or double quotation marks ( " "). (Example: "ABCDE") Note that the NULL character\*1 becomes the termination character.

- \*1 Character string: 00H  
Unicode character string: 0000H



For details on character string data, refer to the following.

MELSEC iQ-F FX5 Programming Manual (Instructions, Standard Functions/Function Blocks)

## 4.13 Initial Device Value Setting

Directly sets the initial value of a device used by the program (i.e., not via the program).

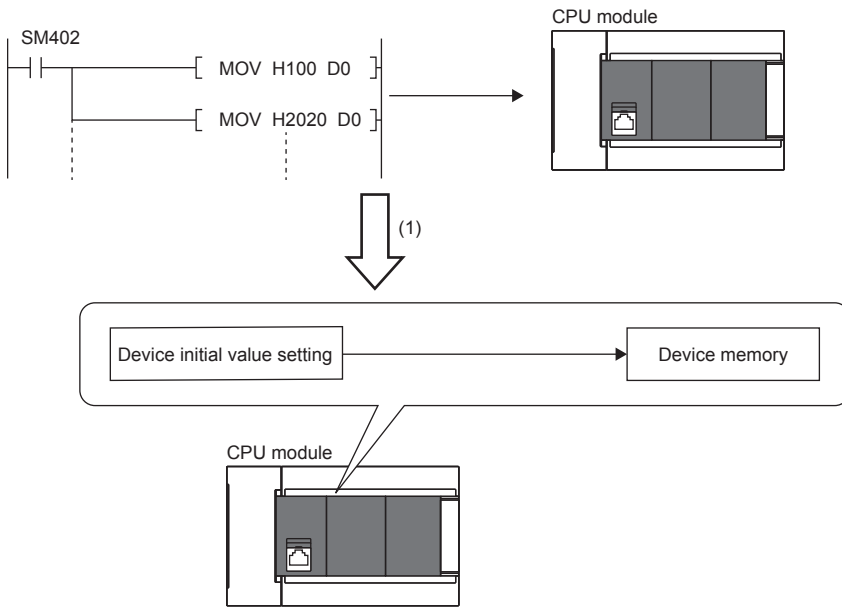





(1) If initial device values are used, a program to set data to the devices becomes unnecessary.

# Setting initial device values

This section describes the settings of initial device values.

## Setting procedure

The procedure for using initial device values is as follows.

1. First, the user must create an initial device value file. To set initial values to a global device, create an initial device value file (with any name) which sets these initial values, and specify the range of the values.
2. On the device memory, set up initial device value data within the range specified in the initial device value file.  
 GX Works3 Operating Manual
3. In the "Device Memory Register Diversion", select the device memory which was set up in Step 2. Setting "Device Memory Register Diversion" enables data set up on the device memory to be used as initial device values for the device which is specified in the initial device value file.  
 GX Works3 Operating Manual
4. Configure CPU parameters. ( Page 76 Initial value setting)
5. Write the set initial device value file and the CPU parameters to the CPU module.  
 GX Works3 Operating Manual
6. The data in the specified initial device value file is automatically set to the specified device when the CPU module is powered off and on, reset, or the status changes from STOP to RUN.

## Initial value setting

Configure the initial value setting.

 Navigation window ⇒ [Parameter] ⇒ [Module model name] ⇒ [CPU Parameter] ⇒ "File Setting" ⇒ "Initial Value Setting"

### Window

Item	Setting
<input type="checkbox"/> <b>Initial Value Setting</b>	
<input type="checkbox"/> Setting of Device Initial Value Use Or Not	Not Use
<input type="checkbox"/> Target Memory	Data Memory
<input type="checkbox"/> Global Device Initial Value File Name	

### Displayed items

Item	Description	Setting range	Default
Setting of Device Initial Value Use Or Not	Sets whether or not to use initial device values.	<ul style="list-style-type: none"> <li>• Not use</li> <li>• Use</li> </ul>	Not use
Target Memory	Sets the storage memory for the initial device value file.	<ul style="list-style-type: none"> <li>• Memory card</li> <li>• Data memory</li> </ul>	Data memory
Global Device Initial Value File Name	Sets the name of the initial global device value file.*1	60 characters or less	—

\*1 If nothing is specified, initial global device values are not applied.

## Number of initial device value settings and maximum range of one range

Up to 1000 ranges can be set in one initial device value file. Up to 8000 data points can be set in one range.

# 4.14 Applicable Devices

For details on devices to which initial device/label values can be set, refer to the following.

 GX Works3 Operating Manual

# 5 LABELS

---

Label is identifier (character string) that specifies a character string in I/O data or internal processing. When a label is used in programming, a program can be created without being conscious about the device No. \* 1

\*1 Label and device can be used in mixed manner.

---

## **Point**

For details on label, refer to the following.

 MELSEC iQ-F FX5 Programming Manual (Program Design)

---

# MEMO

---



# 6 CAPACITY SETTING OF EACH AREA IN DEVICE/LABEL MEMORY

The capacity of each area in device/label memory can be specified.

For FX5UJ CPU module, the setting cannot be changed but the content can be checked.

Item	Symbol	Device		Latch (1)	Latch (2)
		Points	Range		
Input	X	1024	0 to 1777		
Output	Y	1024	0 to 1777		
Internal Relay	M	7680	0 to 7679	500 to 7679	No Setting
Link Relay	B	256	0 to FF	No Setting	No Setting
Link Special Relays	SB	512	0 to 1FF		
Annunciator	F	128	0 to 127	No Setting	No Setting
Step Relay	S	4096	0 to 4095	500 to 4095	
Timer	T	512	0 to 511	No Setting	No Setting
Retentive Timer	ST	16	0 to 15	0 to 15	No Setting
Counter	C	256	0 to 255	100 to 199	No Setting
Long Counter	LC	64	0 to 63	20 to 63	No Setting
Data Register	D	8000	0 to 7999	200 to 7999	No Setting
Latch Relay	L	7680	0 to 7679		
Area Capacity			12.0K Word		11.0K Word
Total Device			11.2K Word		9.6K Word
Total Word Device			10.2K Word		8.1K Word
Total Bit Device			15.9K Bit		25.1K Bit

- (1) The capacity of each area can be changed. (Page 80 Device/Label Memory Area Setting)
- (2) The number of points of user devices can be changed. (Page 81 Device Setting)

## 6.1 Default Capacity of Each Area

The default capacity of each area is as follows.

Item	Capacity
Device (high speed) Area Capacity	12 K words
Device (standard) Area Capacity	35 K words
Label Area Capacity	12 K words
Latch Label Area Capacity	1 K words

## 6.2 The Setting Range of the Capacity of Each Area

The setting range of the capacity of each area on the device/label memory is as follows.

Item	Setting range of capacity of each area
Device (high speed) Area Capacity	0 to 12 K words
Device (standard) Area Capacity	<ul style="list-style-type: none"> <li>■FX5S CPU module 0 to 48 K words</li> <li>■FX5U/FX5UC CPU module 0 to 63 K<sup>*1</sup> words</li> </ul>
Label Area Capacity	0 to 63 K <sup>*1</sup> words
Latch Label Area Capacity	<ul style="list-style-type: none"> <li>■FX5S CPU module 0 to 5K words</li> <li>■FX5U/FX5UC CPU module 0 to 63 K<sup>*1</sup> words</li> </ul>

\*1 For supported version, refer to Page 966 Added and Enhanced Functions.

### Restriction of a label/latch label area capacity

#### ■When device area setting using by label/latch label is standard area

Label Area Capacity + Latch Label Area Capacity + Device (standard) Area Capacity ≤ 63 K<sup>\*1</sup> Word (1 K word unit)

#### ■When device area setting using by label/latch label is high speed area

Label Area Capacity + Latch Label Area Capacity + Device (high speed) Area Capacity ≤ 12 K Word (1 K word unit)

## ■When FB is used

When using FB, the reserved area for adding labels other than the labels defined for FB will be used.

The following capacities are consumed per FB instance.

Label area: 48 words

Latch area: 16 words

\*1 For supported version, refer to  Page 966 Added and Enhanced Functions.

# 6.3 Device/Label Memory Area Setting

The capacity of each data area allocated within the device/label memory can be changed.

 Navigation window ⇒ [Parameter] ⇒ [Module model name] ⇒ [CPU Parameter] ⇒ "Memory/Device Setting" ⇒ "Detailed Setting" ⇒ "Device/Label Memory Area Setting" window

## Operating procedure

"Device/Label Memory Area Setting" window

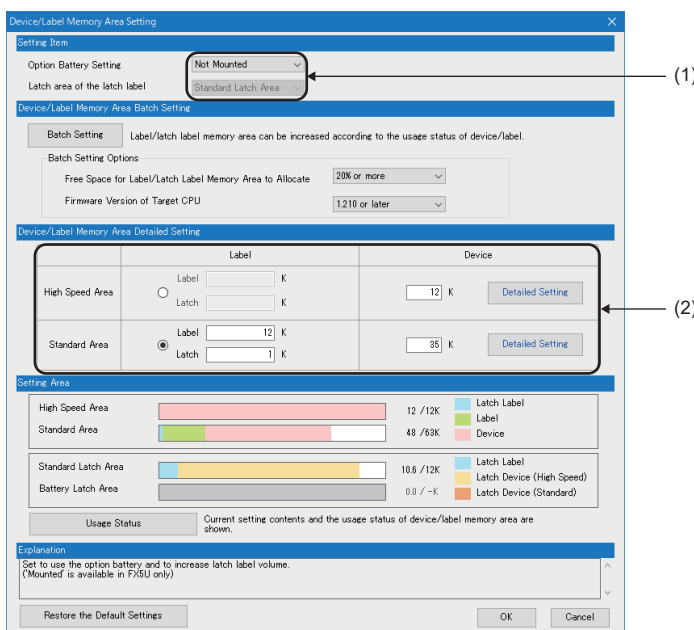

1. In "Option Battery Setting", select whether or not to use a option battery. (Only when the option battery is used)
2. In "Device/Label Memory Area Setting" window, set the capacity of each area.

## Displayed items

(1) Whether or not to use an option battery, and latch area setting for the latch type label can be changed.

Only FX5U/FX5UC CPU module is supported.

Items	Description	Setting range	Default
Option Battery Setting	Set when using option battery. The points which can be held can be increased by this setup.	<ul style="list-style-type: none"> <li>• Not Mounted</li> <li>• Mounted</li> </ul>	Not Mounted
Latch area of the latch label	The latch device of standard area can be held with a battery. The latch area of latch label can be changed to battery latch area from standard latch area (nonvolatile memory).	<ul style="list-style-type: none"> <li>• Standard Latch Area</li> <li>• Battery Latch Area</li> </ul>	Standard Latch Area

(2) The device/label memory area capacity can be set.

Items	Label	Device
High-speed Area	Label:	Set the capacity of device (standard) area. The number of device points in the detail settings, and the latch settings can be changed. For details, refer to  Page 81 Device Setting.
Standard Area	Set label area capacity used in the global label, local label. <sup>*1</sup> Latch: Set the latch label area capacity used for the latch type label. <sup>*1</sup>	

\*1 For details on the setting range for each area capacity, refer to  Page 79 The Setting Range of the Capacity of Each Area.

High-speed area: Area which can be accessed at high speed. Latch is always held by nonvolatile memory.  
 Standard area: Area which can be held when option battery is used. In addition, about a latched type label, when a latch area is set as a standard latch area, latch type label is held by nonvolatile memory.

## 6.4 Device Setting

The number of points of each user device can be changed.

 Navigation window ⇒ [Parameter] ⇒ [Module model name] ⇒ [CPU Parameter] ⇒ "Memory/Device Setting" ⇒ "Device/Label Memory Area Setting" ⇒ "Device/Label Memory Area Detailed Setting" ⇒ "Device (high speed) Setting/Device (standard) Setting" ⇒ "Detailed Setting"

### Window

"Device (high speed) Setting" details window

Item	Symbol	Device		Latch (1)	Latch (2)
		Points	Range		
Input	X	1024	0 to 1777		
Output	Y	1024	0 to 1777		
Internal Relay	M	7680	0 to 7679	Setting	No Setting
Link Relay	B	256	0 to FF	No Setting	No Setting
Link Special Relay	SB	512	0 to 1FF		
Annunciator	F	128	0 to 127	No Setting	No Setting
Step Relay	S	4096	0 to 4095	Setting	
Timer	T	512	0 to 511	No Setting	No Setting
Retentive Timer	ST	16	0 to 15	Setting	No Setting
Counter	C	256	0 to 255	Setting	No Setting
Long Counter	LC	64	0 to 63	Setting	No Setting
Data Register	D	8000	0 to 7999	Setting	No Setting
Latch Relay	L	7680	0 to 7679		
Area Capacity			12.0K Word		11.0K Word
Total Device			11.9K Word		9.6K Word
Total Word Device			10.2K Word		8.1K Word
Total Bit Device			27.9K Bit		25.1K Bit

"Device (standard) Setting" details window

Item	Symbol	Device		Latch (1)	Latch (2)
		Points	Range		
File Register	R	32768	0 to 32767	No Setting	No Setting
Link Register	W	512	0 to 1FF	No Setting	No Setting
Link Special Register	SW	512	0 to 1FF		
Area Capacity			35.0K Word		----
Total Device			33.0K Word		0.0K Word
Total Word Device			33.0K Word		0.0K Word
Total Bit Device			0.0K Bit		0.0K Bit

Specify each item so that the total number of points for each user device does not exceed the capacity of the device area. ( Page 80 Device/Label Memory Area Setting)

## Range of use of device points

The following table lists the range of use of device points to be set in the device setting.

### Device (high speed) Setting

Type	Device name	Symbol	Range of use		Increment of setting	
			FX5S/FX5U/FX5UC CPU module	FX5UJ CPU module	FX5S/FX5U/FX5UC CPU module	FX5UJ CPU module
Bit	Input	X	X0 to X1777	X0 to X1777	—	—
Bit	Output	Y	Y0 to Y1777	Y0 to Y1777	—	—
Bit	Internal relay	M	M0 to M32767	M0 to M7679	64 points	—
Bit	Link relay	B	B0 to B7FFF	B0 to B7FF	64 points	—
Bit	Link special relay	SB	SB0 to SB7FFF	SB0 to SB7FF	64 points	—
Bit	Annunciator	F	F0 to F32767	F0 to F127	64 points	—
Bit	Step relay	S	S0 to S4095	S0 to S4095	—	—
Word	Timer	T	T0 to T1023	T0 to T511	16 points	—
Word	Retentive timer	ST	ST0 to ST1023	ST0 to ST15	16 points	—
Word	Counter	C	C0 to C1023	C0 to C255	16 points	—
Word	Long counter	LC	LC0 to LC1023	LC0 to LC63	16 points	—
Word	Data register	D	D0 to D7999	D0 to D7999	4 points	—
Bit	Latch relay	L	L0 to L32767	L0 to L7679	64 points	—

### Device (standard) Setting

Type	Device name	Symbol	Range of use		Increment of setting	
			FX5S/FX5U/FX5UC CPU module	FX5UJ CPU module	FX5S/FX5U/FX5UC CPU module	FX5UJ CPU module
Word	File registers	R	R0 to R32767	R0 to R32767	4 points	—
Word	Link register	W	W0 to W7FFF	W0 to W3FF	4 points	—
Word	Link special register	SW	SW0 to SW7FFF	SW0 to SW3FF	4 points	—

#### Point

Extended file register (ER) is the device held only in the SD memory card. The device setting is not required for an extended file register (ER), and range of use is ER0 to ER32767.

# 7 DEVICE/LABEL ACCESS SERVICE PROCESSING SETTING

This is a function to optionally designate the frequency of execution of the service process that is carried out by the END process in the parameter.

Improvement of communication response with peripheral equipment and extension of scan time by the service process can be controlled by service process setting function. With this, building an optimal service process environment on the system is possible.

## About device/label access service processing

Device/label access service processing is a response process for the request statement from peripheral equipment that occurs asynchronously with the scan process. (A process of "Interpretation of Request statement→Internal processing based on the request→Creating response statement" for 1 request statement)

The execution timing of the service process is during the END process.

### Point

When every request statement from all connected peripheral equipment is executed in each END process, depending on the number of request statements arriving during 1 scan, the impact on scan time (delay, scattering) may be big. Therefore, by setting the frequency (number of ports) of device/label access service processing to be executed in 1 END processing and regulating the frequency of device/label access service processing according to the system built, ensuring balance between scan time and response time to the peripheral equipment can be achieved.

7

## Compatibility of service process setting

The compatibility of service process setting is described below.

○: Target, —: Not applicable

Communication type	Function	Compatible CPU module		
		FX5S	FX5UJ	FX5U/FX5UC
Serial communication	MELSOFT connection	○	○	○
	MC protocol communication	○	○	○
	MODBUS communication (slave)	○	○	○
	N:N Network	—	—	—
	MODBUS communication (master)	—	—	—
	Non-protocol communication	—	—	—
	Inverter communication	—	—	—
	Predefined protocol support	—	—	—
	Parallel link	—	—	—
Ethernet communication	MELSOFT connection	○	○	○
	SLMP communication	○	○	○
	Simple CPU communication (server)	○	○	○
	Socket communication	—	—	—
	Predefined protocol support	—	—	—
	Simple CPU communication (client)	—	—	—
USB communication	MELSOFT connection	○	○	—

## Operation details of service process

The operation details of service process are described below.

The following table shows the methods for service process with their respective features.

Device/label access service processing setting	Scan performance		Service process performance		Device splitting <sup>*5</sup>	Features
	Extension <sup>*1</sup>	Stability <sup>*2</sup>	Response time <sup>*3</sup>	Stability <sup>*4</sup>		
None	Large	Medium	Fast	High	None	Effective when service process is given precedence.
Set the frequency of service process	Medium	High	Medium	Medium	None	Effective when scan process is given precedence.

\*1 Shows the maximum a scan time is extended by the service process.

\*2 Shows the extent of fluctuation of scan time or the degree of scattering by the service process.

\*3 Shows the time between receiving a service process request from the peripheral equipment to returning a response.

\*4 Shows the extent of fluctuation of time until returning the response or the degree of scattering due to the contents of service process request from the peripheral equipment.

\*5 Shows if device splitting will occur.

### ■Device/label access service processing setting "No Setting"

Since all service processes can be executed normally for every scan time, steady communication is possible even on a system that uses multiple peripheral equipment.



Wait for request process will not be executed when there is no request data.

### ■Device/label access service processing setting "Set Processing Counts"

Because a frequency of service process executed in 1 scan time can be set, the scan time is stabilized even on a system that uses multiple peripheral equipment.

## Operation during STOP/PAUSE

Regardless of the service process settings during STOP/PAUSE, execute all requests in scan 1.

However, a request from the identical port will be processed only 1 time in 1 scan.

For example, after serial communication CH1 process, even if serial communication CH1 receives a new command request again when Ethernet connection 1 is in process, the 2nd request is not executed in this scan and will be carried over to the next scan.

## Setting method

The device/label access service processing can be configured as follows.

Navigation window ⇒ [Parameter] ⇒ [Module model name] ⇒ [CPU Parameter] ⇒ "Service Processing Setting" ⇒ "Device/Label Access Service Processing Setting"

### Window

Item	Setting
Device/Label Access Service Processing Setting	
Specifying Method	No Setting
Counts	1 Times

### Displayed items

Item	Description	Setting range	Default
Specifying Method	Set the method of device/label access service processing.	<ul style="list-style-type: none"> <li>Set Processing Counts</li> <li>No Setting</li> </ul>	No Setting
Counts	Set the number of executions of device/label access service processing.	1 to 10 [Time] (1 time Unit)	—

## Precautions

If "Set Processing Counts" is selected and many service process frequencies are set, when multiple requests are received at the same time, scan time may be prolonged to a large extent, so please exercise caution.

This part consists of the following chapters.

8 FUNCTION LIST

---

9 FIRMWARE UPDATE FUNCTION

---

10 ONLINE CHANGE

---

11 INTERRUPT FUNCTION

---

12 SCAN MONITORING FUNCTION

---

13 CONSTANT SCAN

---

14 REMOTE OPERATION

---

15 LATCH FUNCTION

---

16 RAS FUNCTIONS

---

17 EXTERNAL INPUT/OUTPUT FORCED ON/OFF FUNCTION

---

18 CLOCK FUNCTION

---

19 SECURITY FUNCTIONS

---

20 DATA LOGGING FUNCTION

---

21 MEMORY DUMP FUNCTION

---

22 INTERNAL BUFFER CAPACITY SETTING

---

23 DATA BACKUP/RESTORATION FUNCTION

---

24 REAL-TIME MONITOR FUNCTION

---

25 MEMORY CARD FUNCTION

---





# 8 FUNCTION LIST

The following table lists the functions of the CPU module.

○: Supported, △: Limitedly supported, ×: Not supported

Function		Description	Compatible CPU module			Reference
			FX5S	FX5UJ	FX5U/ FX5UC	
Program capacity setting		Set to change program capacity.	×	×	○	Page 49
Initial device value setting		Sets the initial values of devices used in the program directly (not via the program) to the devices.	○	○	○	Page 75
Device/label memory area setting		Sets the capacity of each area in the device/label memory.	○	×	○	Page 79
Device/label access service processing setting		Sets the number of execution times of the device/label access service processing executed by END processing, with parameter.	○	○	○	Page 83
Firmware update function		Updates the firmware of the module.	○	○	○	Page 89
Online change	Changing ladder blocks while online	Writes the part of a program edited on the ladder editor using the engineering tool to the CPU module in units of ladder blocks. Edited contents spanning multiple portions can be written to the CPU module at once.	○	○	○	Page 106
Interrupt function	Multiple interrupt function	When an interrupt occurs while an interrupt program triggered by another cause is running, stops the program if its priority is lower than that of the new interrupt, and runs the higher-priority program whenever its execution condition is satisfied.	○	○	○	Page 109
	Input interrupt delay function	Execution of the interrupt program can be delayed in units of 1 ms.	○	○	○	Page 111
Scan monitoring function (Watchdog timer setting)		Detects an error in the hardware and program of the CPU module by monitoring the scan time.	○	○	○	Page 114
Constant scan		Keeps the scan time constant and executes program repeatedly.	○	○	○	Page 116
Remote operation	Remote RUN/STOP	Changes the CPU module status to the RUN/STOP/PAUSE status externally while the RUN/STOP/RESET switch of the CPU module is in RUN status.	○	○	○	Page 118
	Remote PAUSE					
	Remote RESET	Resets the CPU module externally while the CPU module is in the STOP status.	○	○	○	
Latch function		Holds the contents of the device and label of the CPU module when the power is turned ON etc.	○	○	○	Page 123
RAS function	Self-diagnostics function	Self-diagnoses the CPU module to see whether an error exist or not.	○	○	○	Page 127
	Error clear	Batch-clears all the continuation errors being detected.	○	○	○	
	Event history function	Collects operations executed and errors detected from the modules, and saves them in the CPU module, expansion board, expansion adapter, and intelligent module. The saved logs can be checked in chronological order.	○	○	○	
External input/output forced on/off function		Forcibly turns on/off the external input/output from the engineering tool.	○	○	○	Page 135
Clock function		This function is used for the time management in the function which the system operates such as the date of the event history function, and data logging function.	○	○	○	Page 141
Security function		Protects resources stored in PCs and resources in the units in the system of the FX5 from illegal access by a third party such as theft, alteration, accidental operation and unauthorized execution.	○	○	○	Page 145 GX Works3 Operating Manual
Data logging function		Collects data at the specified interval or any desired timing, and stores them as a file on the SD memory card.	△ <sup>*1</sup>	○	○	Page 147
Memory dump function		Saves the data in the devices of the CPU module at a desired timing.	△ <sup>*1</sup>	○	○	Page 197

Function		Description	Compatible CPU module			Reference
			FX5S	FX5UJ	FX5U/ FX5UC	
Internal buffer capacity setting		Sets the capacity of the area (internal buffer) used by the system to temporarily store the results of data logging and memory dump processing.	○	○	○	Page 206
Data backup/restoration function		Backs up program files, parameter files, and device/label data files in a CPU module to an SD memory card. The backup data can be restored as needed.	△*1	○	○	Page 208
Real-time monitor function		Monitors the data in the specified device of the CPU module at a specified interval or at a desired timing in real time.	○	○	○	Page 226
Memory card function	SD memory card forced stop	Makes the SD memory card unavailable without turning OFF the power even when the function accessing the SD memory card is executed.	△*1	○	○	Page 228
	Boot operation	Transfers the file stored in the SD memory card to the transfer destination memory judged automatically by the CPU module when the power is turned ON or is reset.	△*1	○	○	
High-speed input/output function	High-speed counter function	Performs high-speed counter, pulse width measurement, input interruption, etc. by using the input of the CPU module or high-speed pulse input/output module.	○	○	○	Page 232
	Pulse width measurement function					Page 297
	Input interrupt function					Page 71
	PWM output function	Executes a PWM output by using the transistor output of the CPU module or high-speed pulse input/output module.	○	○	○	Page 319
Positioning function		Executes positioning operation by using the transistor output of the CPU module or high-speed pulse input/output module.	○	○	○	Page 331
Analog function		Uses the analog input function and analog output so that voltage input/voltage output can be performed.	○	○	○	Page 541
PID control via instruction function		Performs PID control by the PID instruction.	○	○	○	Page 564
PID control via parameter function		Performs PID control (standard PID control, heating-cooling PID control) by using GX Works3 parameters.	×	×	○	Page 601
IP filter function		Identifies the IP address of external devices over Ethernet, and blocks access from an invalid IP address.	○	○	○	MELSEC iQ-F FX5 User's Manual (Communication)
Built-in Ethernet function		An Ethernet related function such as connection to MELSOFT products and GOTs, socket communication, file transfer function (FTP server, FTP client), Web server (HTTP), SNMP client, and simple CPU communication function.	○	○	○	MELSEC iQ-F FX5 User's Manual (Communication)
CC-Link IE Field Network Basic function		Exchanges data between the master station and remote station using general-purpose Ethernet.	○	○	○	CC-Link IE Field Network Basic Reference Manual
Serial communication function		A function related to the serial communication such as N:N Network, parallel link, MC protocol, inverter communication function and non-protocol communication.	○	○	○	MELSEC iQ-F FX5 User's Manual (Communication)
MODBUS communication function		Connection with the products which support MODBUS RTU/TCP is available. The master and slave functions can be used.	○	○	○	MELSEC iQ-F FX5 User's Manual (Communication)
SFC function		Executes programs written in sequential function chart (SFC).	○	○	○	MELSEC iQ-F FX5 Programming Manual (Program Design)

\*1 An SD memory card module is required.

# 9 FIRMWARE UPDATE FUNCTION

This function is used when the user obtains the firmware update file from the Mitsubishi Electric FA website, and updates the firmware version.

The firmware can be updated by the following methods.

Method	Description
Update using an SD memory card	The CPU module firmware can be updated only with an SD memory card without using any special tool.
Update using the engineering tool	The CPU module/intelligent function module firmware can be updated by using the engineering tool.

For supported version of firmware update function, refer to  Page 966 Added and Enhanced Functions.

## 9.1 Update Using an SD Memory Card

The CPU module firmware can be updated by using an SD memory card. The firmware can be updated only with an SD memory card without using special software.

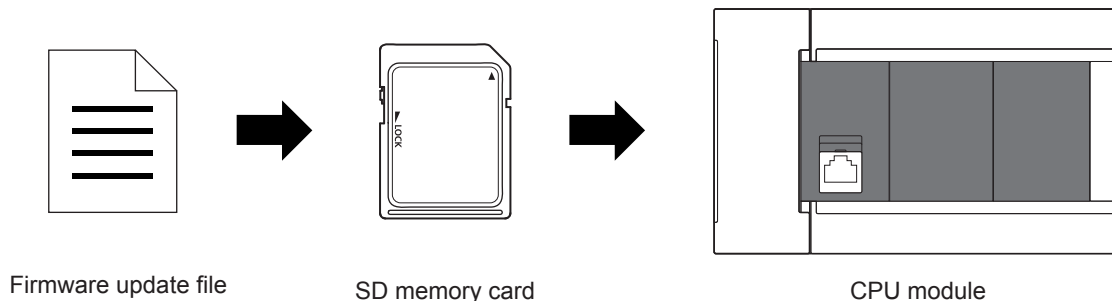

- Point** 
- In system configurations where the CPU module (system) for which the firmware to be updated is connected to a network, etc., an error may occur when the firmware update is executed. Therefore, confirm the system's safety before executing the firmware update.
  - Back up the various data such as the programs and parameters before executing the firmware update.

### Target models

The target models are listed below.

Product name	Model name
FX5S CPU module	FX5S-30MR/ES, FX5S-30MT/ES, FX5S-30MT/ESS, FX5S-40MR/ES, FX5S-40MT/ES, FX5S-40MT/ESS, FX5S-60MR/ES, FX5S-60MT/ES, FX5S-60MT/ESS, FX5S-80MR/ES <sup>*1</sup> , FX5S-80MT/ES <sup>*1</sup> , FX5S-80MT/ESS <sup>*1</sup>
FX5UJ CPU module	FX5UJ-24MR/ES, FX5UJ-24MT/ES, FX5UJ-24MT/ESS, FX5UJ-40MR/ES, FX5UJ-40MT/ES, FX5UJ-40MT/ESS, FX5UJ-60MR/ES, FX5UJ-60MT/ES, FX5UJ-60MT/ESS, FX5UJ-24MR/DS, FX5UJ-24MT/DS, FX5UJ-24MT/DSS, FX5UJ-40MR/DS, FX5UJ-40MT/DS, FX5UJ-40MT/DSS, FX5UJ-60MR/DS, FX5UJ-60MT/DS, FX5UJ-60MT/DSS
FX5U CPU module	FX5U-32MR/ES, FX5U-32MT/ES, FX5U-32MT/ESS, FX5U-64MR/ES, FX5U-64MT/ES, FX5U-64MT/ESS, FX5U-80MR/ES, FX5U-80MT/ES, FX5U-80MT/ESS, FX5U-32MR/DS, FX5U-32MT/DS, FX5U-32MT/DSS, FX5U-64MR/DS, FX5U-64MT/DS, FX5U-64MT/DSS, FX5U-80MR/DS, FX5U-80MT/DS, and FX5U-80MT/DSS
FX5UC CPU module	FX5UC-32MT/D, FX5UC-64MT/D, FX5UC-96MT/D, FX5UC-32MR/DS-TS, FX5UC-32MT/DS-TS, FX5UC-32MT/DSS, FX5UC-32MT/DSS-TS, FX5UC-64MT/DSS, FX5UC-96MT/DSS

\*1 These models are offered for specific regions.

# CPU module firmware update

## Firmware update method

### ■Preliminary preparations

1. Download the firmware update information for the model to be updated from the Mitsubishi Electric FA website.
2. Decompress the firmware update information (ZIP file).
3. Store the "\$MELPRJ\$" containing the firmware update file and Web page update file<sup>\*1</sup> into the root folder of the SD memory card using a personal computer. When another "\$MELPRJ\$" is already stored in the SD memory card, delete the "\$MELPRJ\$" and then store the "\$MELPRJ\$" containing the firmware update file.

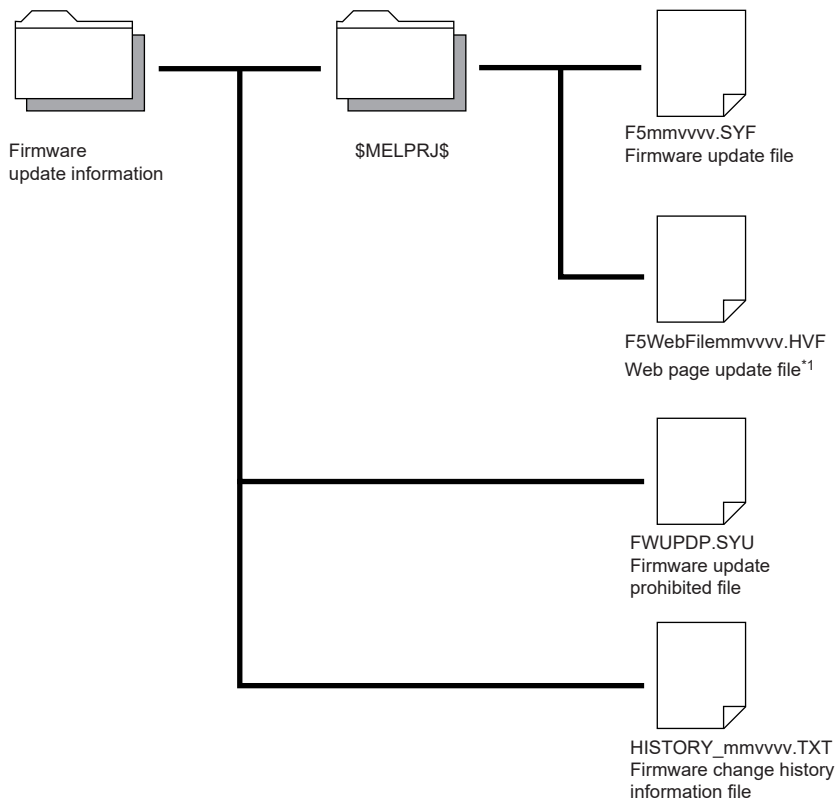

### Restriction

When updating the firmware to version "1.060" and later on the FX5U/FX5UC CPU module, store the firmware update file and Web page update file in the same firmware update information (ZIP file) into the \$MELPRJ\$ folder. If the files which are not compatible with each other are stored into the \$MELPRJ\$ folder, the update will not be completed.

4. If updating of the firmware is prohibited, cancel the prohibit setting. (☞ Page 94 Canceling the firmware update prohibited setting)

### Restriction

Store the "\$MELPRJ\$" folder into the SD memory card using a personal computer. The "\$MELPRJ\$" folder cannot be written into the SD memory card with the engineering tool.

5. Before executing the firmware update, back up the various data such as the programs and parameters stored in the CPU module by using the engineering tool. Also, use the backup/restoration function to hold latch devices. (☞ Page 208 DATA BACKUP/RESTORATION FUNCTION)

\*1 The file attached to the firmware update information (ZIP file) of FX5U/FX5UC CPU module with firmware version "1.060" and later. The file is required when updating the firmware version "1.060" and later. For the FX5S/FX5UJ CPU modules, the file is required from the first released product.

## ■ Operation

1. Execute RUN→STOP and turn the CPU module power OFF, and insert the SD memory card into the CPU module.
2. When the CPU module power turns on and the firmware update starts, the CARD LED blinks.
3. Wait until the RUN LED and ERR LED blink.\*<sup>1</sup> When the LEDs do not blink, refer to step 1 of Page 95 Troubleshooting.
4. Confirm that the RUN LED and ERR LED blink, and then restart or reset the CPU module.



5. The RUN LED and ERR LED blink. Wait until the LEDs turn off.\*<sup>2</sup> If the LEDs do not turn off, refer to step 2 of Page 95 Troubleshooting.
6. Confirm that the RUN LED and ERR LED turn off, and then restart or reset the CPU module.



7. The RUN LED and ERR LED blink. Wait until the LEDs turn off.\*<sup>3\*4</sup> When the firmware update is completed, the RUN LED and ERR LED stop blinking.



8. After the PWR LED turns on, check the engineering tool's "Module Diagnosis (CPU Diagnosis)", and check that the firmware version has been updated.

[Diagnostics] ⇨ [Module Diagnostics(CPU Diagnostics)]

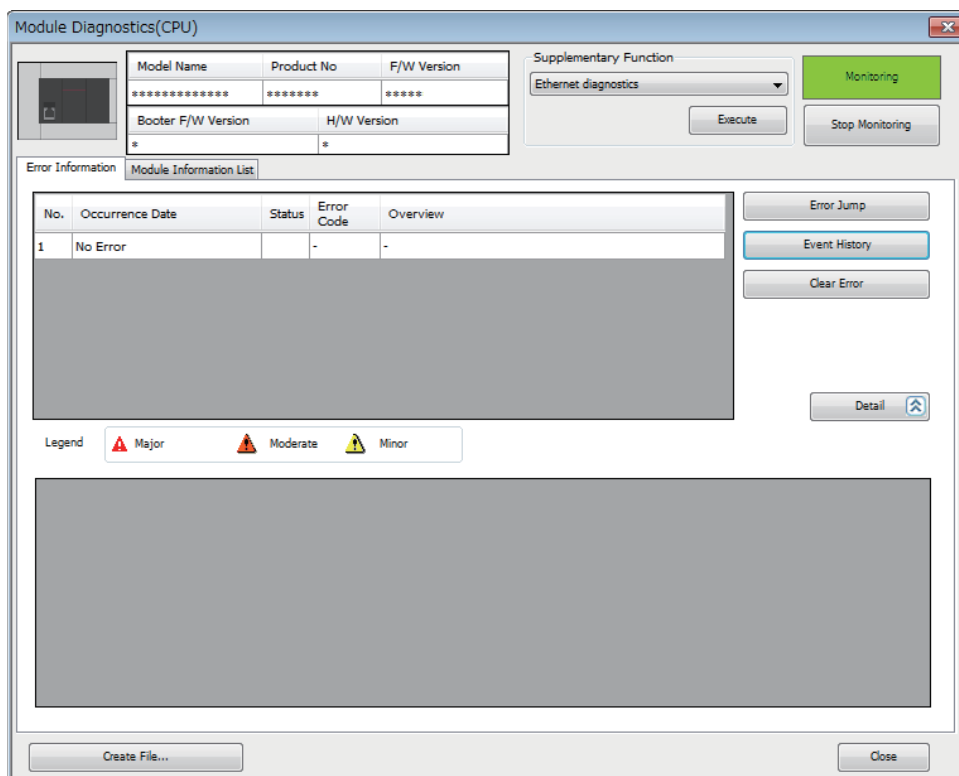

**9.** Turn the CPU module power OFF and remove the SD memory card. Delete the firmware update file from the removed SD memory card.

\*1 The waiting time is as follows.

- FX5S CPU module: Up to 70 seconds
- FX5UJ CPU module: Up to 120 seconds
- FX5U/FX5UC CPU module: Up to 90 seconds

\*2 The waiting time is as follows.

- FX5S CPU module: Up to 60 seconds
- FX5UJ/FX5U/FX5UC CPU module: Up to 45 seconds

\*3 The waiting time is as follows.

- FX5S CPU module: Up to 30 seconds
- FX5UJ CPU module: Up to 90 seconds
- FX5U/FX5UC CPU module: Up to 90 seconds

\*4 For the FX5U/FX5UC CPU modules, this operation is required when the firmware version is "1.045" and later.

**Point**

- Communication with other modules and communication with the engineering tool or external devices is not possible while the firmware update is being executed.
- During firmware update, the data memory will be backed up<sup>\*5</sup> to the SD memory card.<sup>\*7</sup>
- If the firmware is updated correctly, the data memory will be restored<sup>\*5</sup> from the SD memory card to the CPU built-in memory.<sup>\*7</sup> After the data memory is restored, the data memory backup file in the SD memory card will be deleted.
- If the data memory fails to be restored, restart or reset the CPU module, and a recovery retry<sup>\*6</sup> will be executed.<sup>\*7</sup> While the data memory is being restored by recovery retry, the RUN LED and ERR LED blink slowly (five seconds or more). The LED will turn OFF when the file is correctly recovered. If the recovery fails again, the ERR LED will blink.
- The firmware version can also be confirmed with the special register (SD8001).
- After the firmware is updated, if a firmware update file that differs from the CPU module's firmware version is stored in the "\$MELPRJ\$" folder of the SD memory card, the firmware will be updated.

\*5 Refer to  Page 966 Added and Enhanced Functions for the versions that support data memory save/recovery of FX5U/FX5UC CPU module.

\*6 Refer to  Page 966 Added and Enhanced Functions for the versions that support data memory recovery retry of FX5U/FX5UC CPU module.

\*7 For the FX5S CPU module, the firmware update can be executed without save/recovery, no save/recovery is executed.

## Firmware update prohibited setting

Updating of the firmware can be prohibited by writing the firmware update prohibited file into the CPU module.

- Using the engineering tool, select the folder containing the firmware update prohibited file (FWUPDP.SYU) as the write target file, and select the CPU built-in memory for the write target. The firmware update prohibited file is stored in the firmware update information downloaded during the preliminary preparations. (  Page 90 Firmware update method)

 [Online] ⇒ [User Data] ⇒ [Write]

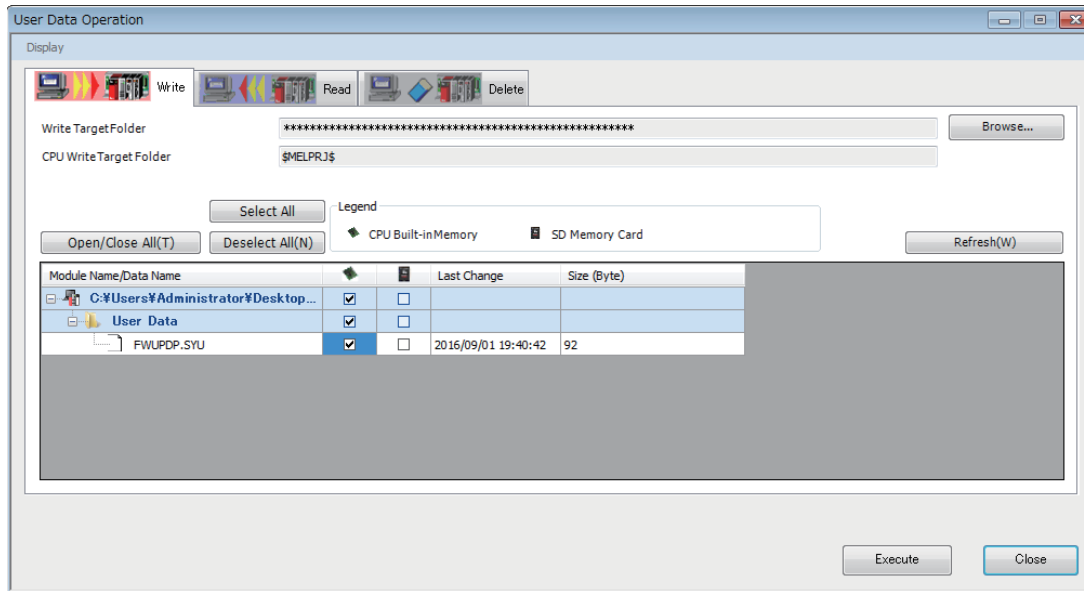

- Using the engineering tool, set a file password for the firmware update prohibited file. \* 1

 [Project] ⇒ [Security] ⇒ [File Password Setting]

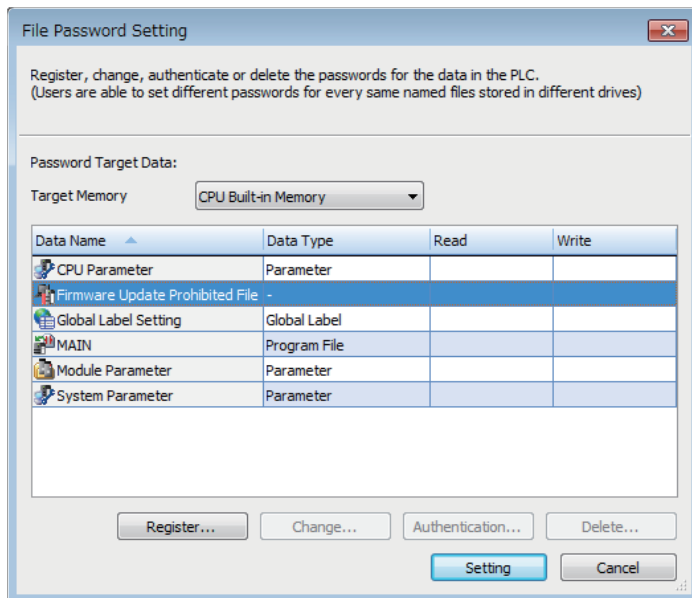

For details on operation, refer to the following.

 GX Works3 Operating Manual

\*1 Refer to  Page 966 Added and Enhanced Functions for the versions that support file password setting for the firmware update prohibited file.

### Point

The firmware update permit/prohibit state can be confirmed with the special relay (SM912).

## Canceling the firmware update prohibited setting

When executing the firmware update, cancel the prohibit setting with the engineering tool.

1. Delete the file password for the firmware update prohibited file.

 [Project] ⇒ [Security] ⇒ [File Password Setting]

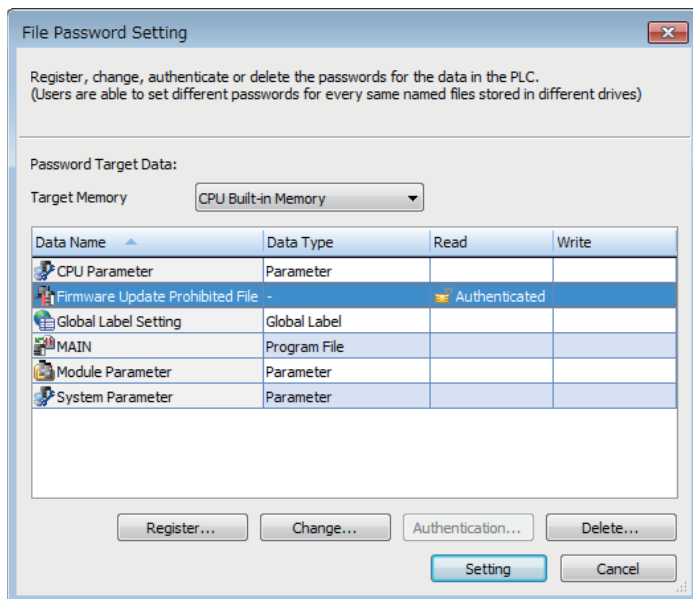

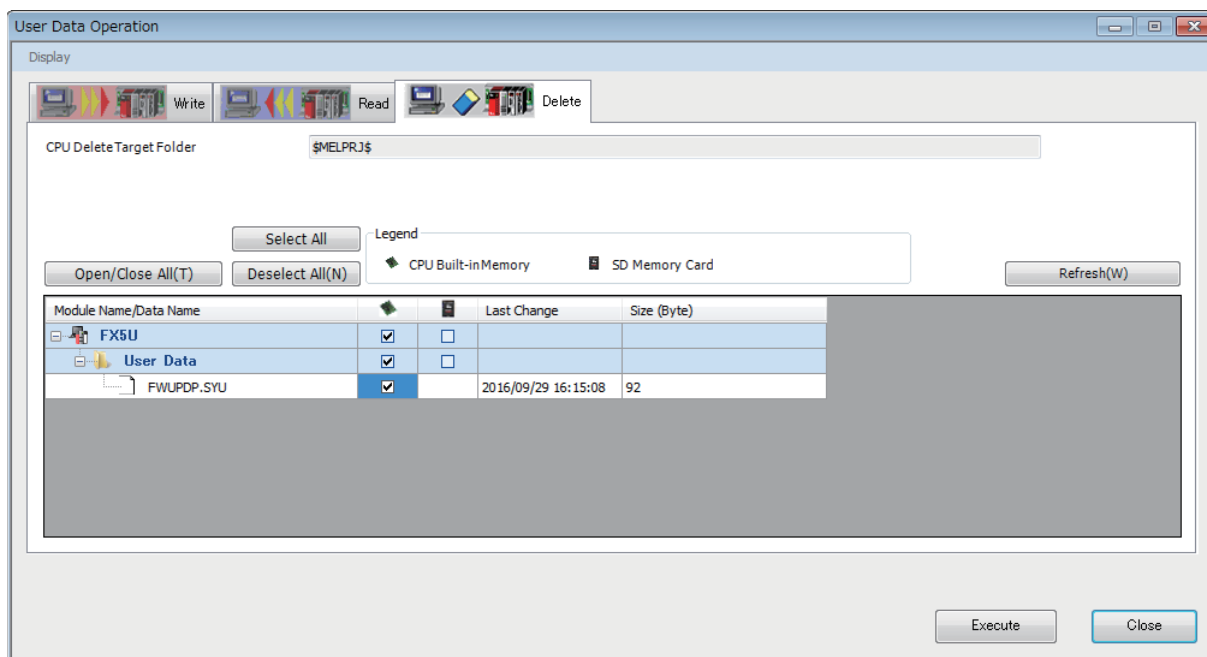

2. Delete the firmware update prohibited file from the CPU built-in memory.

 [Online] ⇒ [User Data] ⇒ [Delete]



### Point

The firmware update prohibited file can also be deleted with the following method. Note that the program, etc., will also be deleted.

- Memory operation (initialization) ( GX Works3 Operating Manual)
- Clearing the CPU built-in memory before booting with boot operation ( Page 230 Boot Operation)



## Precautions

- Back up the various data such as the programs and parameters before executing the firmware update.
- Check the target model, and download the correct firmware update file from the Mitsubishi Electric FA website. The firmware will not be updated if the target model does not match.
- Do not change the data (folder and file name) downloaded from the Mitsubishi Electric FA website.
- Do not turn the power OFF or reset the CPU module while the firmware update is in progress. Doing so may cause programs to be deleted.
- Do not remove the SD memory card while the firmware update is in progress. If the SD memory card is removed before the firmware update finishes, the process may end with an error.
- When the firmware version of the CPU module is updated by the firmware update function, some functions have restrictions depending on the serial No. For details on operation, refer to  Page 966 Added and Enhanced Functions.
- To update the firmware of the CPU module to version "1.100" or later, use the CPU module with serial No. as follows.
  - FX5UC-32MT/DS-TS and FX5UC-32MT/DSS-TS: Serial No.178\*\*\*\*
  - FX5U/FX5UC CPU module other than the above: Serial No.17X\*\*\*\*
- For the FX5U/FX5UC CPU module with the serial No. 2114001 or later, downgrading to previous firmware version "1.220" or earlier cannot be performed. Update error (3040H) will occur and the firmware will not be updated.
- For the FX5UJ CPU module with the serial No. 2154001 or later, downgrading to previous firmware version "1.010" or earlier cannot be performed. Update error (3040H) will occur and the firmware will not be updated.
- For the FX5UJ-□MT/D□ and the FX5UJ-□MR/D□, downgrading to previous firmware version "1.050" or earlier cannot be performed. Update error (3040H) will occur and the firmware will not be updated.

## Troubleshooting

If an error occurs, take corrective action according to the error code. ( Page 851 List of error codes)

If the error cannot be judged by the error code, check the following items and troubleshoot the situation.

Procedure	Error details	Action
1	The LED turns off and does not blink.	<ul style="list-style-type: none"> <li>• Check that the SD memory card is inserted.</li> <li>• If the FX5S CPU module is used, check that the SD memory card module is mounted.</li> <li>• Check whether the folder name and file name to be stored in the SD memory card are correct.</li> <li>• Check whether the same firmware version has already been written in.</li> <li>• Obtain the firmware update file from the Mitsubishi Electric FA website, and update the file in the SD memory card.</li> </ul>
2	The RUN LED turns off and the ERR LED is blinking.	Reset the CPU module. If the same situation occurs again, the hardware of the CPU module may be malfunctioning. Consult your local Mitsubishi Electric representative.

# 9.2 Update Using the Engineering Tool

## CPU module firmware update

The CPU module firmware can be updated by using the engineering tool. This function enables the firmware to be updated without using an SD memory card.

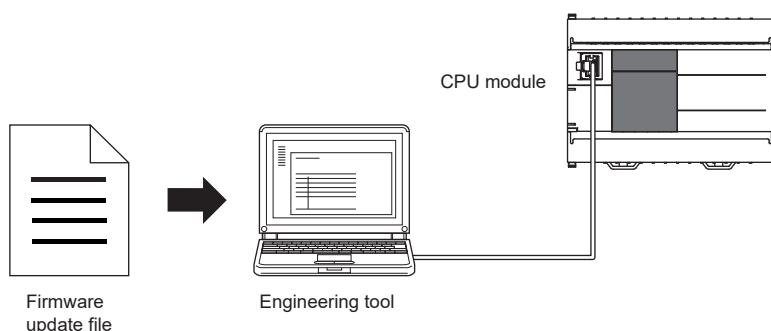

## Target models

The target models are listed below.

Product name	Model name
FX5S CPU module	FX5S-30MR/ES, FX5S-30MT/ES, FX5S-30MT/ESS, FX5S-40MR/ES, FX5S-40MT/ES, FX5S-40MT/ESS, FX5S-60MR/ES, FX5S-60MT/ES, FX5S-60MT/ESS, FX5S-80MR/ES*1, FX5S-80MT/ES*1, FX5S-80MT/ESS*1

\*1 These models are offered for specific regions.

## Supported engineering tool

The engineering tool supporting the firmware update function is shown below.

Engineering tool	Software version
GX Works3	"1.080J" or later

## Communication route

The communication routes between the engineering tool supporting the firmware update function and the CPU module are shown below. For details, refer to the following.

📖 MELSEC iQ-F FX5 User's Manual (Communication)

### ■ Direct connection to an Ethernet port

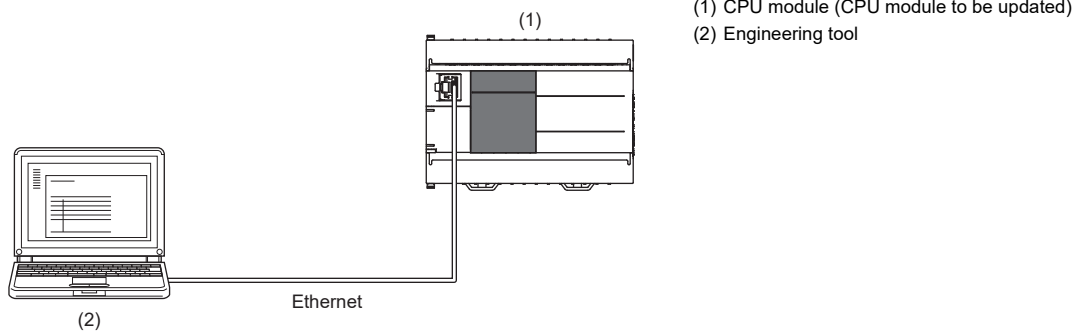

### ■ Connection via hub

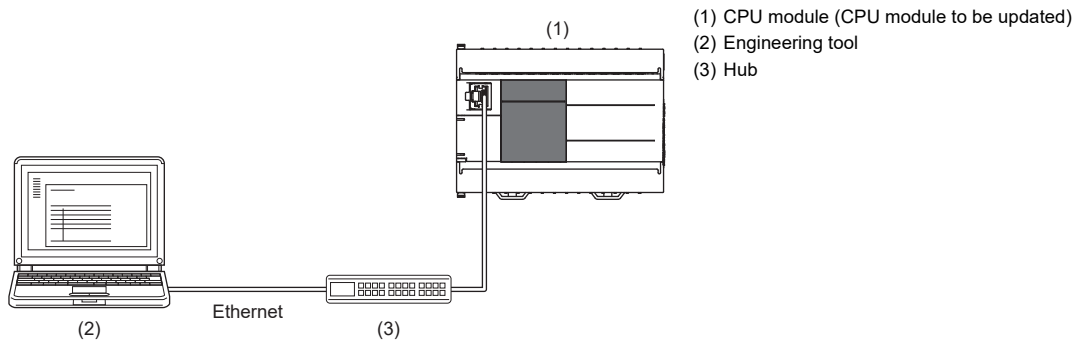

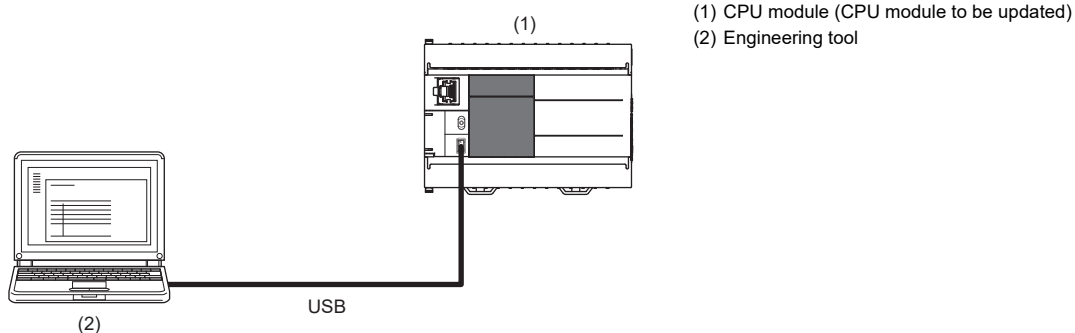

### ■ USB connection



## Firmware update method

### ■Preliminary preparations

1. Download the firmware update information for the model to be updated from the Mitsubishi Electric FA website.
2. Decompress the firmware update information (ZIP file).
3. Store the "\$MELPRJ\$" folder containing the firmware update file and Web page update file into a desired folder.
4. Connect the engineering tool to the CPU module.
5. Stop the CPU module and system for which the firmware update function is to be executed. Turn off the power to other systems and devices connected to the CPU module. If the power cannot be turned off, disconnect communication cables.
6. Check that no other function is executed on the CPU module.
7. Check that no file operations such as writing to the programmable controller, online change, and file transfer function are executed. (If the update is started with a file operation being executed, the operated file may be damaged.)
8. If updating of the firmware is prohibited, cancel the prohibit setting. (  Page 94 Canceling the firmware update prohibited setting)
9. Check that no stop errors have occurred on the CPU module.
10. Before executing the firmware update, back up the various data such as the programs and parameters stored in the CPU module by using the engineering tool. Also, use the backup/restoration function to hold latch devices. (  Page 208 DATA BACKUP/RESTORATION FUNCTION)

### ■Operation

1. Turn the CPU module power ON.
2. Display the firmware update screen of the engineering tool.

 [Tool] ⇒ [Update Firmware]

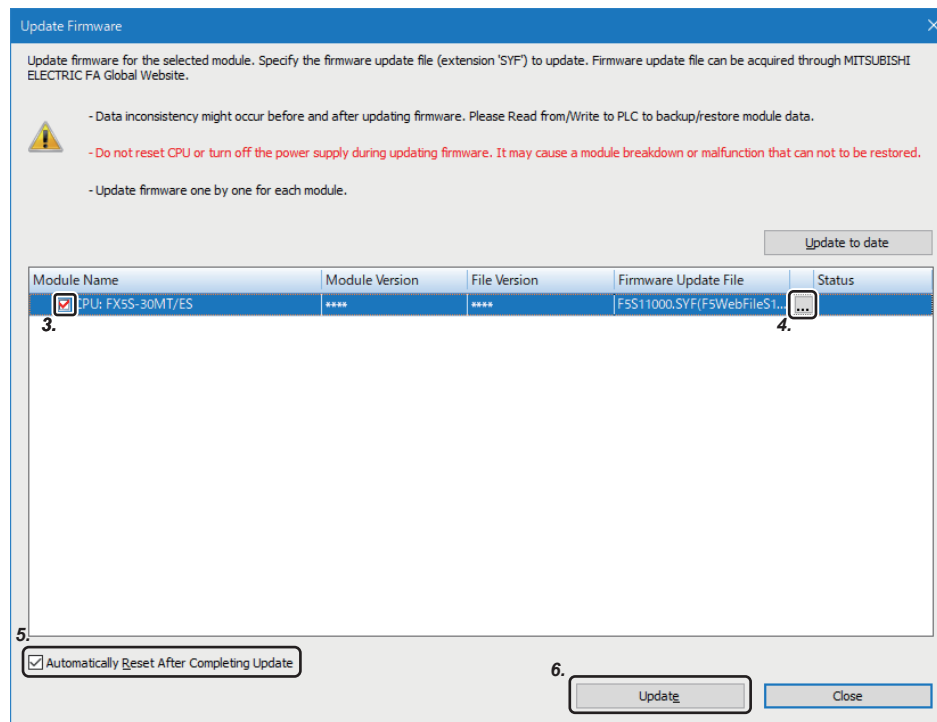

3. Select the CPU module whose firmware will be updated.
4. Click [...], and select the firmware update file.
5. The CPU module is automatically reset. To prevent the CPU module from being automatically reset, deselect it. If it is deselected, the module will wait until it is manually reset after the completion of the firmware update.
6. Click [Update] to update the firmware. It takes about 2 minutes to complete the update. After the firmware update is started, the update status can be checked in the "Status" column.
7. If you did not check the box in 5 (Not automatically reset), turn the system power OFF and ON after the completion of the firmware update.
8. On the module diagnosis screen of the engineering tool, check that the firmware version has been updated.

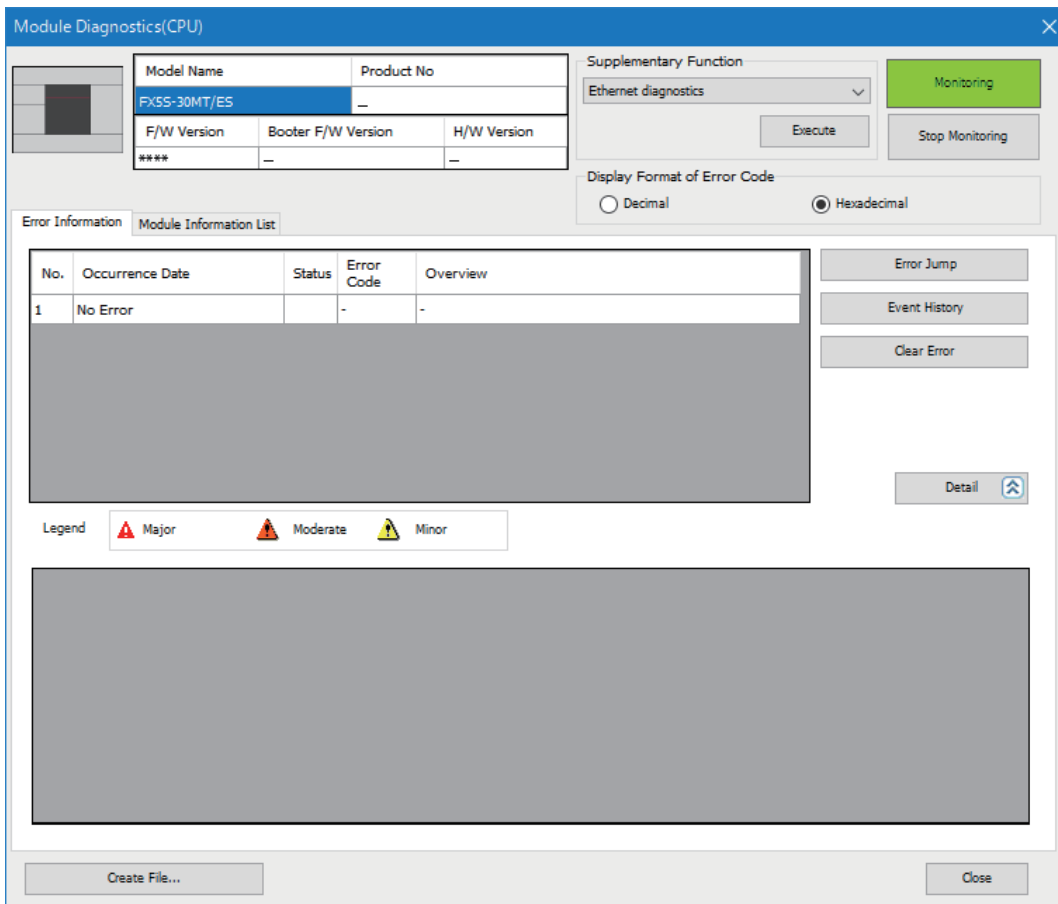

## Firmware update prohibited setting

For the firmware update prohibited setting, refer to the following.

- ☞ Page 93 Firmware update prohibited setting
- ☞ Page 94 Canceling the firmware update prohibited setting

## Precautions

- Check the target model, and download the correct firmware update file from the Mitsubishi Electric FA website. The firmware will not be updated if the target model does not match.
- Do not change the data (folder and file name) downloaded from the Mitsubishi Electric FA website.
- If the CPU module to be updated cannot be selected in the engineering tool, update the engineering tool version.
- After checking that the CPU module to be updated is normally running, update the firmware.
- After checking that other functions have stopped, update the firmware.
- Update the firmware after checking that other systems connected on the network have stopped.
- Do not update the firmware while a function that accesses the SD memory card such as the file transfer function is in operation.
- Back up the various data such as the programs and parameters before executing the firmware update.
- Do not turn the power OFF or reset the CPU module while the firmware update is in progress.
- If the firmware update is interrupted due to reasons such as the cable between the CPU module and the engineering tool being disconnected or the engineering tool being terminated, the update may be completed with an error. For the recovery, check that the LED indication for the CPU module does not show that data is being written and reset the CPU module manually. When updating the firmware from a remote location, check that the CPU module can be reset manually before doing so.
- If the firmware update is completed with an error and "To Use or Not to Use DNS Server Settings" is set to "Use" in the web server settings, an error may occur. In this case, update the firmware again.
- If any of the following operations is performed during the period from the start to the end of the firmware update, the firmware update may complete with an error, or the module may be damaged.
  - Turning off the power to the system under firmware update, or resetting the system
  - Remotely operating from the engineering tool, or changing the operation status with the CPU module switch
  - Operating the system under firmware update from an external device
  - Connecting/disconnecting the communication cable connecting the CPU module and engineering tool
  - Operating the engineering tool to start the firmware update
  - Stopping the engineering tool

# Updating the firmware for the intelligent function module

The intelligent function module firmware can be updated by using the engineering tool.

Write the firmware update information from the engineering tool to the CPU module. The firmware of the target module can be updated by the CPU module writing the firmware information to the target module to be updated. (Hereinafter, the CPU module that writes the firmware update information is referred to as the update writing CPU module.)

An SD card must have been installed in the update writing CPU module in advance.

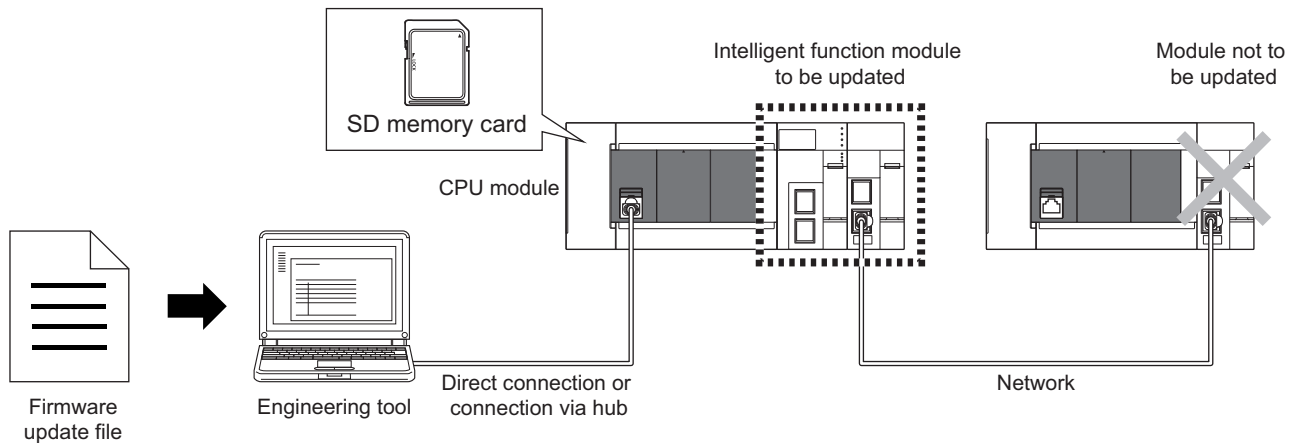

## Point

- In other system configurations where the intelligent function module (system) for which the firmware to be updated is connected with a network, etc., an error may occur when the firmware update is executed. Therefore, confirm the system's safety before executing the firmware update.
- Back up the various data such as the programs in the CPU module and parameters before executing the firmware update.
- Only one intelligent function module can be updated by executing the function once.
- The intelligent function modules connected on the network are excluded from the firmware update.

## Target models

The target modules to be updated, and the models and versions compatible with the update writing CPU module are shown below.

### ■Update writing CPU module

The CPU modules that can write the firmware update file to the intelligent function modules via the engineering tool are shown below.

- FX5UJ CPU module
- FX5U CPU module
- FX5UC CPU module

### Target modules to be updated

The firmware of the following models can be updated.

Target modules to be updated				Firmware version of the update writing CPU module	Version of the engineering tool
Product	Model	Firmware version	Serial No.		
Intelligent function module	FX5-ENET	"1.003" and above	209**** and above	<ul style="list-style-type: none"> <li>FX5UJ CPU module "1.030" and above</li> <li>FX5U/FX5UC CPU module "1.240" and above</li> </ul>	"1.075D" and above
	FX5-ENET/IP	"1.003" and above	209**** and above		
	FX5-CCLIEF	"1.005" and above	20X**** and above		
	FX5-CCLGN-MS	Initial product and above	Initial product and above		
	FX5-OPC	Initial product and above	Initial product and above		
	FX5-40SSC-G	Initial product and above	Initial product and above		
	FX5-80SSC-G	Initial product and above	Initial product and above		

**Point**

If the CPU module is not compatible, update the CPU module via an SD memory card. (Page 89 Update Using an SD Memory Card)

### Communication route

The communication routes between the engineering tool supporting the firmware update function and the CPU module are shown below. For details, refer to the following.

MELSEC iQ-F FX5 User's Manual (Communication)

#### Direct Connection

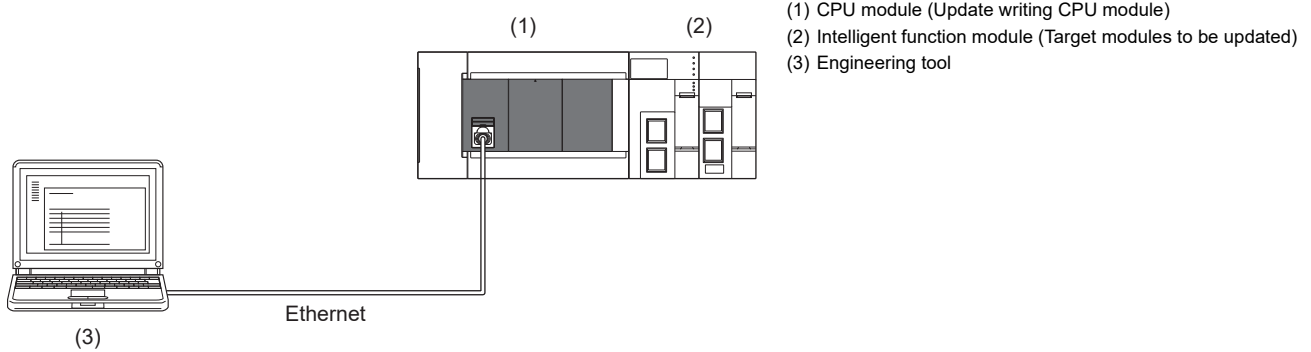

#### Connection via hub

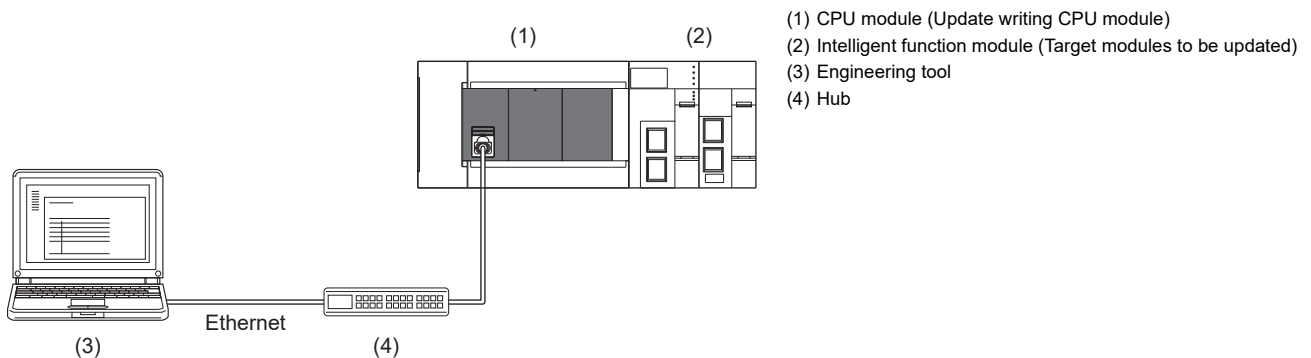

**Restriction**

Connection via GOT Transparent is not supported.

## Firmware update method

### ■Preliminary preparations

1. Download the firmware update information for the model to be updated from the Mitsubishi Electric FA website.  
(Firmware update file: F5mmvvv.SYF)
2. If updating of the firmware is prohibited, cancel the prohibit setting. (☞ Page 94 Canceling the firmware update prohibited setting)
3. Before executing the firmware update, back up the various data such as the programs and parameters stored in the CPU module by using the engineering tool. Also, use the backup/restoration function to hold latch devices. (☞ Page 208 DATA BACKUP/RESTORATION FUNCTION)
4. Enable remote RESET. (☞ Page 121 Enabling remote RESET)
5. Execute RUN→STOP and turn the CPU module power OFF, and insert the SD memory card into the CPU module.

### Restriction

If the SD memory card contains the firmware update files of the CPU module and intelligent function module, the firmware cannot be updated. Delete the firmware update files of the CPU module and intelligent function module from the SD memory card before starting the update.

### ■Operation

1. Turn the CPU module power ON.
2. Display the firmware update screen of the engineering tool.

☞ [Tool] ⇒ [Update Firmware]

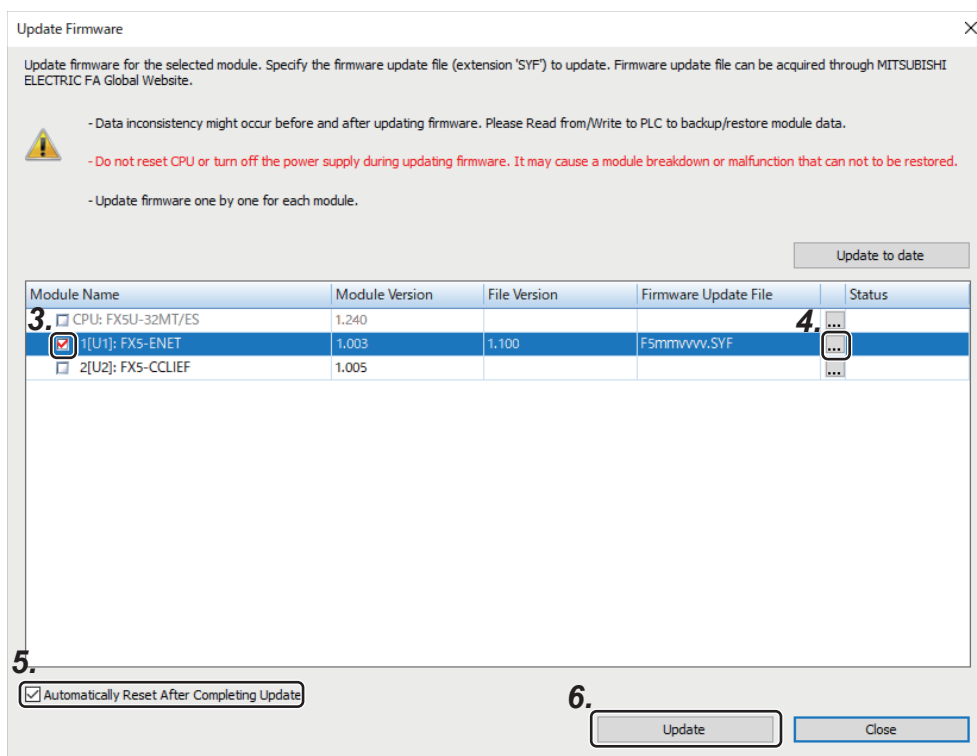



3. Select the intelligent function module whose firmware will be updated.
4. Click [...], and select the firmware update file.
5. The CPU module is automatically reset. To prevent the CPU module from being automatically reset, deselect it. If it is deselected, the module will wait until it is manually reset after the completion of the firmware update.
6. Click [Update] to update the firmware. It takes about 10 minutes to complete the update. After the firmware update is started, the update status can be checked in the "Status" column.
7. If you did not check the box in 5 (Not automatically reset), turn the system power OFF and ON after the completion of the firmware update.
8. To prohibit the remote RESET, disable remote RESET. (☞ Page 121 Enabling remote RESET)
9. On the "Module diagnosis (intelligent module)" window of the engineering tool, confirm that the firmware has been updated to the latest version.

☞ [Diagnostics] ⇒ [System Monitor] ⇒ [Target module (intelligent function module)]

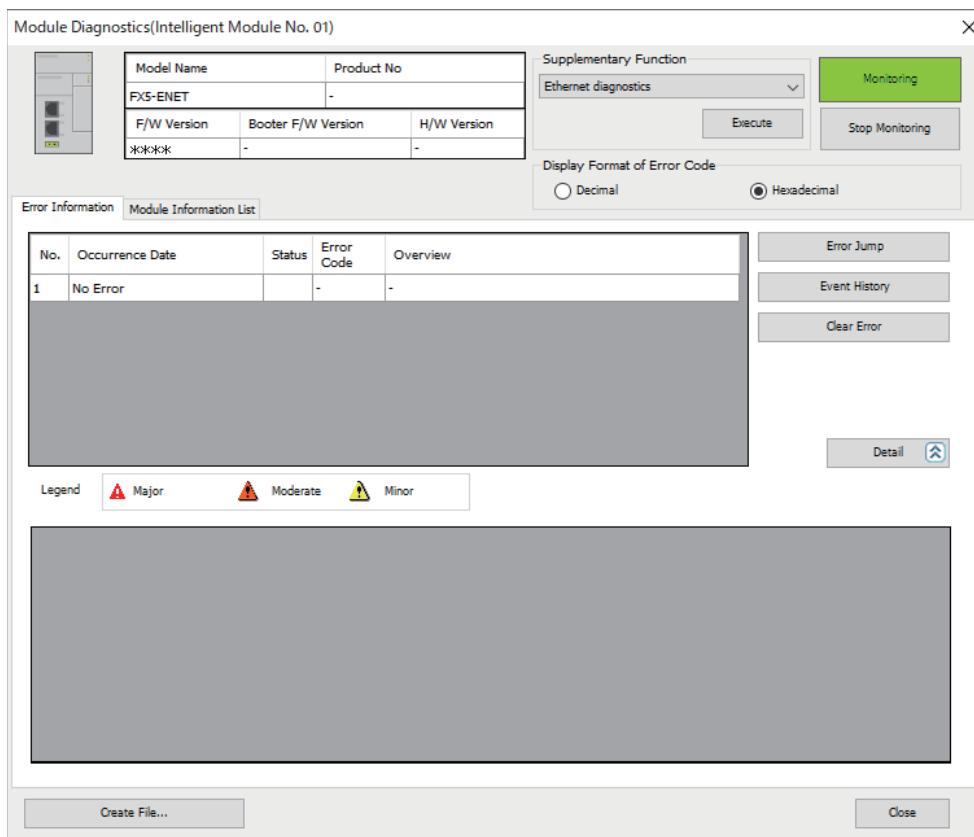

## Firmware update prohibited setting

For the firmware update prohibited setting, refer to the following.

- ☞ Page 93 Firmware update prohibited setting
- ☞ Page 94 Canceling the firmware update prohibited setting

## Precautions

- Check the target model, and download the correct firmware update file from the Mitsubishi Electric FA website. The firmware will not be updated if the target model does not match.
- Do not change the data (folder and file name) downloaded from the Mitsubishi Electric FA website.
- Before executing the firmware update, enable the CPU module reset setting. (  Page 121 Enabling remote RESET) If the update without enabling the reset setting was performed, do not turn the CPU module power OFF and ON or reset the module, and re-execute the update after enabling the reset setting.
- Update the firmware after confirming that the intelligent function module to be updated is normally running.
- Update the firmware after confirming that the function using the intelligent function module and SD memory card has stopped.
- Update the firmware after confirming that other systems connected on the network have stopped. Communication with other systems may be stopped.
- Back up the various data such as the programs and parameters before executing the firmware update.
- Do not turn the power OFF or reset the CPU module while the firmware update is in progress.
- Do not remove the SD memory card while the firmware update is in progress. If the SD memory card is removed before the firmware update finishes, the process may end with an error.
- If the automatic reset is disabled, manually turn the power OFF and ON after the completion of the update.
- If the system malfunctions after the completion of the firmware update, downgrade the firmware to the previous version. If your version is not found on the Mitsubishi Electric FA website, please consult your local Mitsubishi representative.
- If any of the following operations is performed during the period from the start to the end of the firmware update, the firmware update may complete with an error, or the module may be damaged.
  - Turning OFF the power to the system under firmware update, or resetting the system
  - Remotely operating from the engineering tool, or changing the operation status with the CPU module switch
  - Removing the SD memory card
  - Operating the system under firmware update from an external device
  - Connecting/disconnecting the communication cable connecting the CPU module and engineering tool
  - Connecting/disconnecting the module under firmware update
  - Operating the engineering tool to start the firmware update
  - Stopping the engineering tool

## Troubleshooting





If an error occurs, take corrective action according to the error code. (☞ Page 851 List of error codes)

If the error cannot be judged by the error code, check the following items and troubleshoot the situation.

Error details	Action
The firmware update function screen is not displayed.	<ul style="list-style-type: none"> <li>• Check that the communication route is connected to the built-in port of the CPU module (Ethernet (Ethernet port direct connection/connection via hub)), and re-execute the update.</li> <li>• Check whether the firmware version of the CPU module is compatible with the update using the engineering tool. If the CPU module is not compatible, update the CPU module via an SD memory card.</li> </ul>
The update file cannot be set.	Check that the firmware update file downloaded from the Mitsubishi Electric FA website has been selected, and re-execute the update.
The update is not performed even when [Update] is pressed, and an error message dialog is displayed.	<ul style="list-style-type: none"> <li>• Check that the firmware update is not prohibited, and re-execute the update.</li> <li>• Check whether or not the firmware update file of the CPU module or any intelligent function module remains in the "\$MELPRJ\$" folder in the SD memory card. If there is an unnecessary firmware update file, delete the file.</li> <li>• Check that the SD memory card is inserted in the CPU module.</li> <li>• Check that the version of the firmware update file is not the same as the firmware version of the module to be updated.</li> <li>• Check that the remote reset setting is "Enable", and re-execute the update.</li> <li>• Check that the firmware update file downloaded from the Mitsubishi Electric FA website has been selected, and re-execute the update.</li> </ul>
An SD memory card error occurs during execution of the firmware update.	<ul style="list-style-type: none"> <li>• Re-insert the SD memory card, and re-execute the update.</li> <li>• Check that the SD memory card is not write-protected, and re-execute the update.</li> <li>• Format the SD memory card, and re-execute the update.</li> </ul> <p>If the same error still occurs after the above actions are taken, the SD memory card may have a hardware error. Replace the SD memory card.</p>
The error code 1910H occurs during execution of the firmware update.	<ul style="list-style-type: none"> <li>• Check whether or not the firmware update file of the CPU module or any intelligent function module not to be updated remains in the "\$MELPRJ\$" folder in the SD memory card. If there is an unnecessary firmware update file, delete the file.</li> <li>• Format the SD memory card, and re-execute the update.</li> </ul>
The error code 1911H occurs during execution of the firmware update.	Check that the specified intelligent function module is correctly inserted, and re-execute the update.
The error code 3040H occurs during execution of the firmware update.	<ul style="list-style-type: none"> <li>• To execute the firmware update, an intelligent function module compatible with the new version is required. Please consult your local Mitsubishi representative.</li> <li>• Check that the selected firmware update file matches the model of the module to be updated.</li> </ul>
The error code 3041H or 3042H occurs during execution of the firmware update.	Check that the firmware update file downloaded from the Mitsubishi Electric FA website has been selected, and re-execute the update.
A communication timeout occurs during execution of the firmware update.	<p>A communication timeout or a cable trouble may have occurred, or the PLC power is OFF or reset. Execute the following operations.</p> <ol style="list-style-type: none"> <li>(1) Turn the CPU module power OFF and ON, and wait until the ERR LED and RUN LED flash. If the LEDs do not flash after 60 seconds, re-execute the firmware update.</li> <li>(2) Turn the CPU module power OFF and ON again, and wait until the ERR LED and RUN LED turn off. After this, turn the CPU module power OFF and ON again. Then, the firmware update will be completed, and the module will start normally. If the ERR LED flashes and the RUN LED turns off, turn the CPU module power OFF and ON again.</li> </ol> <p>In the following cases, the intelligent function module may have a hardware error. Please consult your local Mitsubishi representative.</p> <ul style="list-style-type: none"> <li>• When the ERR LED flashes and the RUN LED turns off in (2), even after the CPU module power is turned OFF and ON twice, if the ERR LED flashes and the RUN LED turns off</li> <li>• When the RUN LED does not turn off after 60 seconds in (2)</li> </ul>
The firmware update is completed abnormally.	<ol style="list-style-type: none"> <li>(1) Turn the CPU module power OFF and ON, and wait until the ERR LED and RUN LED turn off. If the LEDs do not flash, re-execute the firmware update.</li> <li>(2) Turn the CPU module power OFF and ON again. Then, the firmware update will be completed, and the module will start normally. If the ERR LED flashes and the RUN LED turns off, turn the CPU module power OFF and ON again.</li> </ol> <p>In the following cases, the intelligent function module may have a hardware error. Please consult your local Mitsubishi representative.</p> <ul style="list-style-type: none"> <li>• When the ERR LED flashes and the RUN LED turns off in (2), even after the CPU module power is turned OFF and ON twice, if the ERR LED flashes and the RUN LED turns off</li> <li>• When the RUN LED does not turn off after 60 seconds in (2)</li> </ul>

# 10 ONLINE CHANGE

This chapter describes online change.  
Types of online change are as follows.

Type	Description	Reference
Online ladder block change	Changes only part of the program or data during online change.	 Page 106 Online Ladder Block Change  GX Works3 Operating Manual
Online change (SFC block)	Changes, adds, or deletes SFC blocks during online.	 MELSEC iQ-F FX5 Programming Manual (Program Design)  GX Works3 Operating Manual

## 10.1 Online Ladder Block Change

Writes the portion edited on the ladder edit window of the engineering tool to the CPU module in increments of ladders. Edited contents spanning multiple files or multiple portions can be written to the CPU module at once.

### Point

For details on the operating procedure of online ladder block change on engineering tools, refer to the following.  
 GX Works3 Operating Manual

### Editable contents

Within a program block, instructions and pointers (P, I) can be added, changed, or deleted. Also, as POU unit, program blocks can be added, changed, or deleted. However, when the program/FB file is not in agreement between engineering tool and a CPU module, it cannot be added, changed, or deleted.

### Range changeable in a single session

The following shows the number of steps and number of ladder blocks which can be changed in a single session.

- Number of ladder blocks in a file: 64 blocks or less (32767 steps or less)
- The total of the changed circuit block count in all files: 256 blocks or less
- The total capacity of the program file and the FB file after a change: 1 M bytes or less
- The total capacity of the target data for online change: 192 K bytes or less

### Online ladder block change during the boot operation

If online change of ladder block is executed from the SD memory card during boot operation, the corresponding file in the SD memory card, which is the boot source, can be changed as well.

### Precautions

This section describes the precautions on using online ladder block change.

#### Online change to SFC program

Online change to the SFC program cannot be performed. However, online change to the other programs which coexist with the SFC program (such as the ladder program) can be performed.

#### When deleting OUT instruction which is on

When deleting an OUT instruction (coil) which is not necessary for control, be sure to check that the OUT instruction is off before deleting it. If the OUT instruction is deleted without turning it off in advance, the output will be retained.

#### Program file not registered in program setting

A program file which is not registered in parameter setting cannot be written.

## The cautions at the time of repeatedly performing online change

When online change is performed repeatedly, RUN writing may not be able to be carried out due to insufficient memory in the CPU module. Please set the CPU module to STOP and write the program.

## The size of the target data at online change

When the size of the target data of online change exceeds 192 K bytes, online change fails and an error message is displayed on the engineering tool. The target data size may exceed 192 K bytes in the following cases:

- When the capacity of the edited program file exceeds 192 K byte
- When the total capacity of multiple edited program files exceeds 192 K byte

In the above mentioned cases, divide the program file in advance to reduce each file size, avoid performing online change to multiple program files all at one time (perform online changes to a few files at a time), or take other actions.\*1

\*1 Usually, online change is performed to only edited files. However, in the following cases, online change is performed to a file other than the edited file.

- When a global label or structure is changed, the program using the changed global label and structure is a target of online change.
- When FB or FUN is changed, the program using the changed FB and FUN is a target of online change.

For confirmation of the target file for online change and the file capacity, refer to the following.

 GX Works3 Operating Manual

## Separate writing of a program and program restoration information

- It may take time to write data when writing a program and program restoration information separately.
- A project is automatically saved with the data writing. Therefore, it is necessary to register the project history in advance.
- If a project is not saved automatically, the data will also not be written to a CPU module.
- When writing fails, reset or cycle the power of the CPU module. Then, write the data to the CPU module in the STOP state.

When writing data to a CPU module by using the online program change function, a program and program restoration information can separately be written by setting "Yes" for the following option.

 [Tool] ⇒ [Options] ⇒ "Convert" ⇒ "Online Program Change" ⇒ "Operational Setting" ⇒ "Divide to Write a Program and Program Restore Information"

### Point

By writing a program and program restoration information separately, an error that occurs when the capacity of data to be written to a CPU module exceeds the maximum writable capacity may be cleared.

For supported version of separate writing of a program and program restoration information, refer to  Page 966 Added and Enhanced Functions.

## When the online change (ladder block) is used

### ■ Prohibited operation at online ladder block change

When an online change of ladder block, if the power is turned OFF or a reset is made, the process does not end normally. Such operation is made, execute rewriting to the PLC.

### ■ Initializing the last execution if the ladder at online ladder block change has an FB call

- If a subroutine type FB is called in a FB definition, the execution information of the previous time in the FB definition of the subroutine type FB is not initialized.
- If a macro type FB is called in the FB definition of a subroutine type, the execution information of the previous time in the part equivalent to the macro type FB is not initialized either.

## ■Instructions not compatible with online ladder block change

Do not execute online change to ladder block including the following instruction.

DSZR/DDSZR instruction, DVIT/DDVIT instruction, TBL instruction, DRVTBL instruction, PLSV/DPLSV instruction, DRVII/DDRVI instruction, DRVA/DDRVA instruction, DRVMUL instruction, PLSY/DPLSY instruction, PWM/DPWM instruction, SPD/DSPD instruction, HIOEN/DHIOEN instruction, UDCNTF instruction, DABS instruction, ADPRW instruction, IVCK instruction, IVDR instruction, IVRD instruction, IVWR instruction, IVBWR instruction, IVMC instruction, S(P).CPRTCL instruction, RS2 instruction, SP.SOCOPEN instruction, SP.SOCCLOSE instruction, SP.SOCSND instruction, SP.SOCRCV instruction, SP.ECPRTCL instruction, RBFM instruction, WBFM instruction

## ■The operation when a pulse type instruction is included in the range of an online ladder block change

The operation when a pulse related instruction is included in the range of an online ladder block change is as follows.

Pulse type instruction	Description
Rising instruction (PLS and □P instructions)	When a rising instruction exists within the range to be changed, the rising instruction will not be executed even if the execution condition (OFF to ON) is fulfilled at completion of online program change.
Falling instruction (PLF and □F instructions)	When a falling instruction exists within the range to be changed, the falling instruction will not be executed even if the execution condition (ON to OFF) is fulfilled at completion of online program change.

Rising instruction	Falling instruction
<p>When a rising instruction exists within the range to be changed, the rising instruction will not be executed even if the execution condition (OFF to ON) is fulfilled at online change (ladder block).</p> <p>(1) The rising instruction will not be executed even if the execution condition is OFF to ON.</p>	<p>When a falling instruction exists within the range to be changed, the falling instruction will not be executed even if the execution condition (ON to OFF) is fulfilled at online change (ladder block).</p> <p>(1) The falling instruction will not be executed even if the execution condition is OFF to OFF.  (2) If online program change and transition of ON to OFF occur simultaneously, the falling instruction will not be executed.</p>

## Online change (ladder block) when another function is performed

Online ladder block change cannot be executed while executing the backup/restoration function. (☞ Page 208 DATA BACKUP/RESTORATION FUNCTION) Confirm that the backup/restoration function is not being executed before executing the online ladder block change.

# 11 INTERRUPT FUNCTION

This chapter describes the interrupt function.

## 11.1 Multiple Interrupt Function

When an interrupt occurs while an interrupt program triggered by another cause is running, stops the program if its priority is lower than that of the new interrupt, and runs the higher-priority program whenever its execution condition is satisfied.

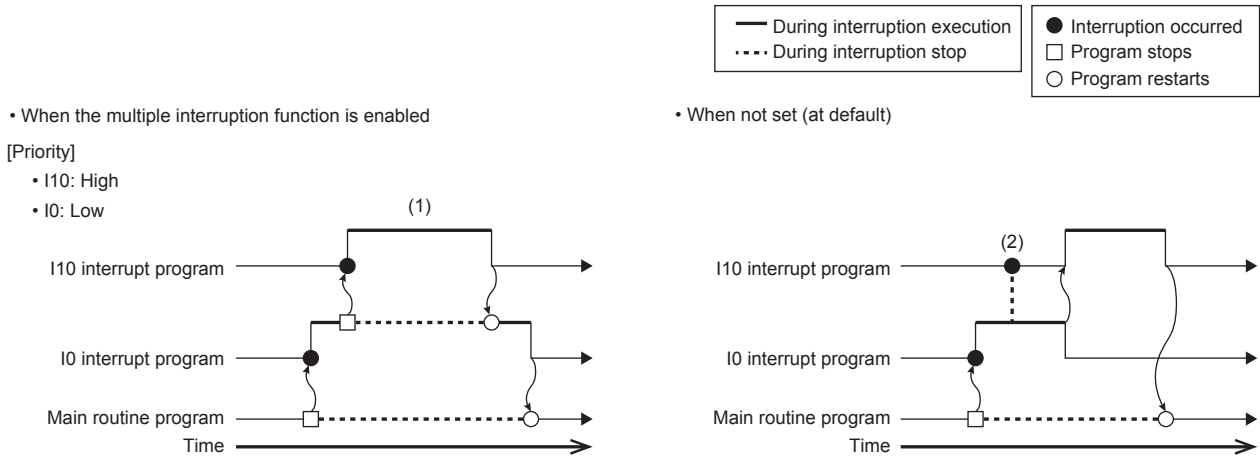

### Precautions

A watchdog timer error may occur under the following conditions.

- When the interrupt frequency is high
- When the interrupt program execution time is long

When a watchdog timer error occurs, review the call frequency and execution time of the interrupt program.

### Interrupt priority

If the interrupt priority of a program for which its execution condition has been satisfied is higher than that of the running program, the programs are executed in accordance with their interrupt priority. If the interrupt priority of the new program is the same or lower, it enters the waiting status until the running program finishes. (Page 72 The priority for the interrupt pointer numbers and interrupt factors)

## Interrupt priority setting

The interrupt priority (1 to 3) of interruptions from modules can be changed.

Navigation window ⇒ [Parameter] ⇒ [Module model name] ⇒ [CPU Parameter] ⇒ "Interrupt Settings" ⇒ "Interrupt Priority Setting from Module"

### Operating procedure

"Interrupt Settings" window

Item	Setting
Interrupt Priority Setting from Module	
Multiple Interrupt	Enable
Interrupt Priority	<Detailed Setting>

"Detailed Setting" window

Interrupt Pointer	Priority
I0	2
I1	2
I2	2
I3	2
I4	2
I5	2
I6	2
I7	2
I8	2
I9	2
I10	2
I11	2
I12	2
I13	2
I14	2
I15	2

1. Set Multiple Interrupt to "Enable" on the "Interrupt Settings" window, and click "Detailed Setting".
2. Change the priority of each interrupt pointer.

### Displayed items

Item	Description	Setting range	Default
Multiple Interrupt	Sets whether or not to enable multiple interrupt.	<ul style="list-style-type: none"> <li>• Disable</li> <li>• Enable</li> </ul>	Disable
Interrupt Priority	Detailed Setting	Sets the priority of the interrupt pointers I0 to I23, I28 to I31, and I50 to I177.	1 to 3 <sup>*1</sup>

\*1 The lower the numerical value, the higher the interrupt priority.

## Disabling/enabling interrupts with a specified or lower priority

Interrupts with a priority equal or lower than that specified by the DI or EI instruction can be disabled or enabled even when multiple interrupts are present.

For details, refer to [IMELSEC iQ-F FX5 Programming Manual \(Instructions, Standard Functions/Function Blocks\)](#).

### Point

Disabled interrupt priorities and the current interrupt priority can be checked in SD758 (Interrupt disabling for each priority setting value) and SD757 (Current interrupt priority) respectively.



# 11.2 Input Interrupt Delay Function

The input interrupt delay function can delay the execution of the interrupt program in units of 1 ms.

By delaying the execution of the interrupt program, the installation position of the sensor used for the input interrupt can be adjusted by program without shifting the actual installation position.

The input interrupt delay function has the following specifications.

☞ Page 111 Delay time setting

☞ Page 112 Delay execution of the interrupt program

### Point

- If this function is used for Interrupt (Rising) + Pulse Catch, pulse catch will not be delayed.
- For versions that support the input interrupt delay function, refer to the following.

☞ Page 966 Added and Enhanced Functions

## Delay time setting

The delay time can be set in units of ms (1 to 32767) for the I0 to I15 interrupt pointers using the pattern program.

### Setting method

The delay time is set by the pattern program.

After the delay time specified by the pattern program has elapsed, the interrupt program is executed.

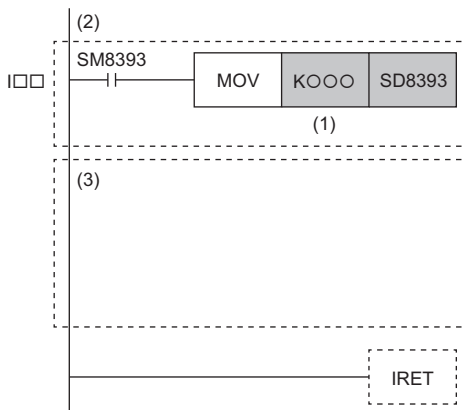

(1) Delay time (unit: ms)

(2) Contact for setting delay time

(3) Programs to be processed by input interrupts

- Always describe the delay time setting program at the top of the interrupt program, and change only the delay time (1). If it is not described at the top of the interrupt program, it will not be recognized as a pattern program and the delay time will not be set.
- Describe the pattern program in the interrupt pointers I0 to I15. If it is described in an interrupt pointer other than I0 to I15, it will not be recognized as a pattern program and the delay time will not be set.
- Only constants (K, H) or data register (D) can be used for this time setting. If any other device is used, the delay time setting becomes invalid and operates as a normal input interrupt. If the set data register (D) is 0 or less, the delay time setting becomes invalid and operates as a normal input interrupt.

### Point

- The pattern programs written for each I-pointer number all use the same SM8393 (delay time setting contact) and SD8393 (delay time). However, different delay times can be set and operated for each I-pointer number.
- If the data register (D) is specified for the delay time setting of the pattern program, the delay time can be changed by changing the value of the data register (D) even while the CPU module is running. In that case, the value stored when the interrupt is generated becomes the delay time. However, if the value at that time is outside the range that can be specified as the delay time, the interrupt program is executed immediately without delay.

# Delay execution of the interrupt program

When an interrupt is generated, the execution of the interrupt program is delayed for the preset delay time.

## Interrupt priorities that can be used

The interrupt priorities that can be used with the input interrupt delay function are shown below.

Interrupt priority	Availability	Remarks
1	×	If it is set, the program operates with no delay time.
2	○	—
3	○	—

## Operation during delay

The following shows the relationship between delay time measurement and interrupt program execution when the status of the CPU module changes during the delay.

### ■If the same interrupt is generated

The interrupt generation timing and interrupt enable/disable patterns are shown below. If the interrupt is disabled, the delay time is not measured and the interrupt program is not executed.

Interrupt generation timing	Interrupt	
During delay	Disabled	
Not during delay	Interrupt program running	Enabled
	Interrupt program not running	Enabled

- Operation when the same interrupt is generated

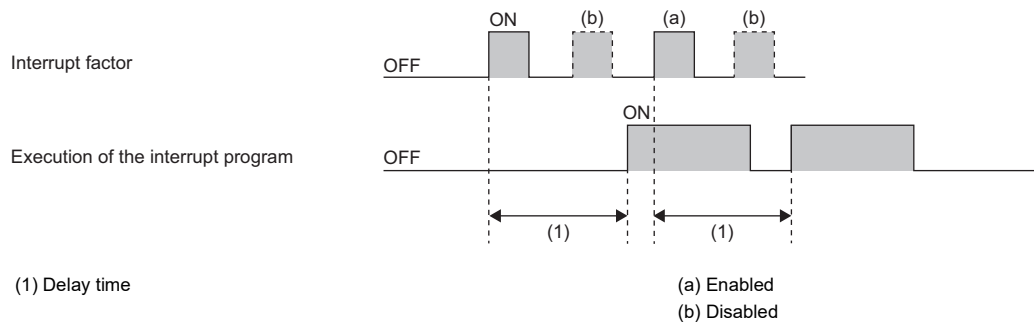

If an interrupt is generated even when interrupt is disabled (DI), it will be delayed. After the delay time has elapsed, the interrupt program is executed as soon as interrupt is enabled (EI).

### ■If the input interrupt delay function operates in the PAUSE state

Even if the CPU module is in the PAUSE state, the delay time is measured when an interrupt is generated. Also, the delay time measurement continues even if the PAUSE state occurs during delay. If the delay time has elapsed during PAUSE, the interrupt program is executed when interrupt is enabled (EI) after RUN. If the same interrupt is generated multiple times during PAUSE, the first interrupt is stored only once.

### ■If the input interrupt delay function operates while interrupt is disabled (DI)

The input interrupt delay function measures the delay time even if interrupt is disabled (DI) for the CPU module when an interrupt is generated.

If interrupt is disabled (DI) after the delay time has elapsed, the interrupt that was generated is stored, and the stored interrupt program is executed when interrupt is enabled (EI). If the same interrupt is generated multiple times, the first interrupt is stored only once. However, note that all interrupt causes are discarded when interrupt disable is specified by the IMASK and SIMASK instructions.

## Precautions

If online change is performed during the delay, the interrupt program will be executed after the delay time has elapsed. However, depending on the timing at which online change is performed, the delay time confirmation operation will not be executed, nor will the interrupt program that is executed after the delay elapses.

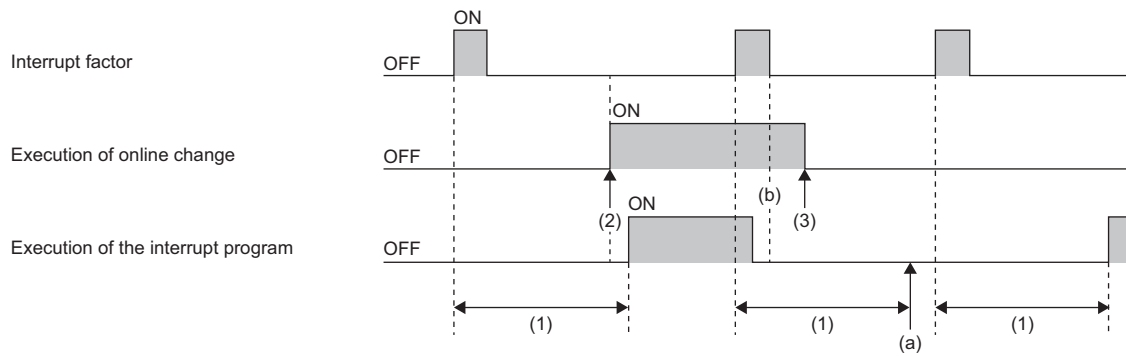

- (1) Delay time
- (2) Online change starts
- (3) Online change disabled

- (a) The interrupt program is not executed.
- (b) Binary modification: The delay time measurement is discarded. Therefore, after the delay time has elapsed, the interrupt program is also not executed.

# 12 SCAN MONITORING FUNCTION

This function detects CPU module hardware or program errors by monitoring the scan time. Using the watchdog timer, which is an internal timer in the CPU module, the following scans are monitored.

- Initial scan (1st scan)
- 2nd scan and after

## 12.1 Scan Time Monitoring Time Setting

Sets the scan time monitoring time.

Navigation window ⇒ [Parameter] ⇒ [Module model name] ⇒ [CPU Parameter] ⇒ "RAS Setting" ⇒ "Scan Time Monitoring Time (WDT) Setting"

### Window

Item	Setting
<b>Scan Time Monitoring Time (WDT) Setting</b>	
Initial Scan	2000 ms
After 2nd Scan	200 ms

### Displayed items

Item	Description	Setting range	Default
Initial Scan	Sets the scan-time monitoring time (WDT) for the initial scan (first scan).	10 to 2000ms (10ms units)	2000 ms
After 2nd Scan	Sets the scan-time monitoring time (WDT) for the second and later scans.	10 to 2000ms (10ms units)	■FX5S CPU module 500ms ■FX5U/FX5UC CPU module 200 ms

## 12.2 Resetting of the Watchdog Timer

Resets the watchdog timer when the END/FEND instruction is executed. When the CPU module operates normally and executes the END/FEND instruction within the watchdog timer setting, the time of the watchdog timer will not time up. If the END/FEND instruction cannot be executed within the watchdog timer setting due to increased program execution as a result of hardware error or interrupt in the CPU module, the time of the watchdog timer will time up.

# 12.3 Precautions

The following precautions relate to the scan monitoring function.

## Watchdog timer reset when executing a program repeatedly

The watchdog timer can be reset by executing the WDT instruction in a program. If the time of the watchdog timer is up while executing a program repeatedly by the FOR instruction and NEXT instruction, use the WDT instruction to reset the watchdog timer.

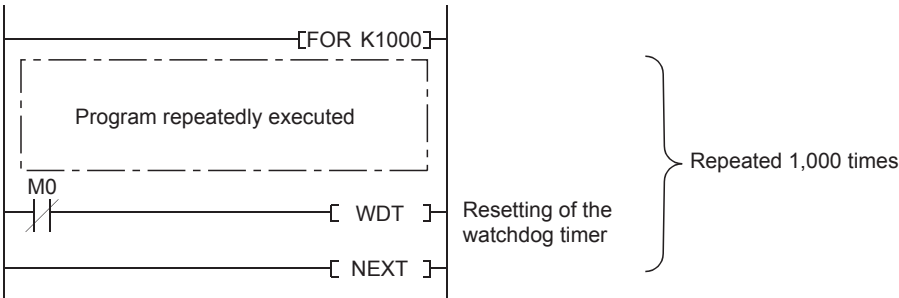

## Scan time when the WDT instruction is used

Even though the watchdog timer is reset using the WDT instruction, the scan time value is not reset. The scan timer value is the value measured up to the END instruction.

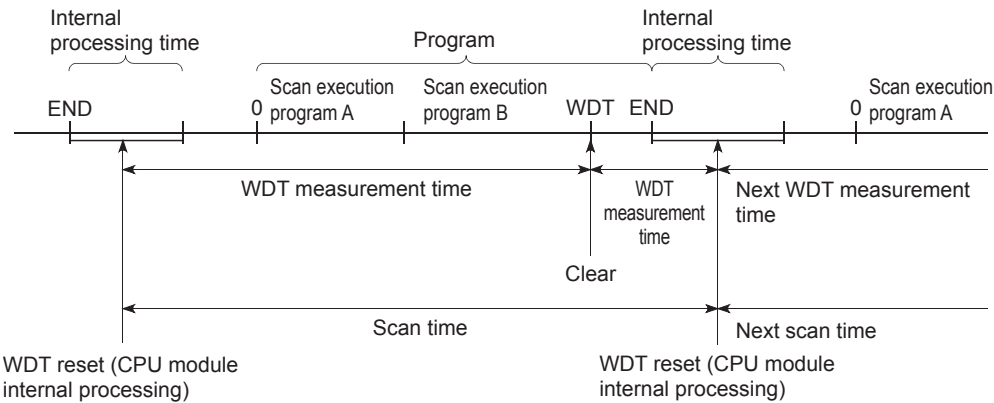

# 13 CONSTANT SCAN

Since the processing time differs as per the execution/non-execution of command used in the program, the scan timer changes with every scan. By setting the constant scan, because a program can be repeatedly executed while keeping scan time at a specified amount of time, even when the execution time of the program changes, the I/O refresh interval can be constant.

- When constant scan is set (Settings value=10 ms)

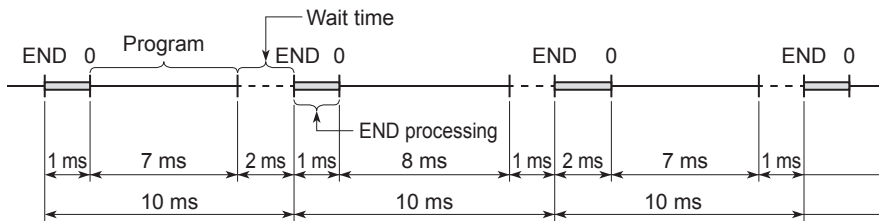

- When constant scan time is not set

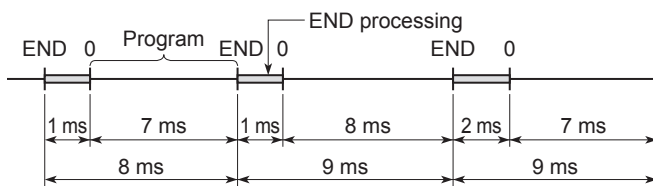

## 13.1 Constant Scan Settings

Sets the constant scan setting.

Navigation window ⇒ [Parameter] ⇒ [Module model name] ⇒ [CPU Parameter] ⇒ "RAS Setting" ⇒ "Constant Scan Setting"

### Window

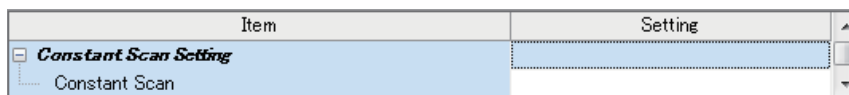

### Displayed items

Item	Description	Setting range	Default
Constant Scan	Sets the constant scan time.	<ul style="list-style-type: none"> <li>■FX5S/FX5UJ CPU module           <ul style="list-style-type: none"> <li>• 0.5 to 2000ms (0.1ms units)</li> </ul> </li> <li>■FX5U/FX5UC CPU module           <ul style="list-style-type: none"> <li>• 0.2 to 2000ms (0.1ms units)</li> </ul> </li> </ul>	—

## Conditions of setting time

Set a value that meets the following relational equation for the setting time of the constant scan.

"WDT setting time" > "Constant scan setting time" > "Maximum scan time of the program"

When the maximum scan time of the program is longer than the setting time of the constant scan, it results in error. The constant scan time is ignored and it is executed with the scan time of the program.

**Ex.**

When the constant scan time is set to 4 ms

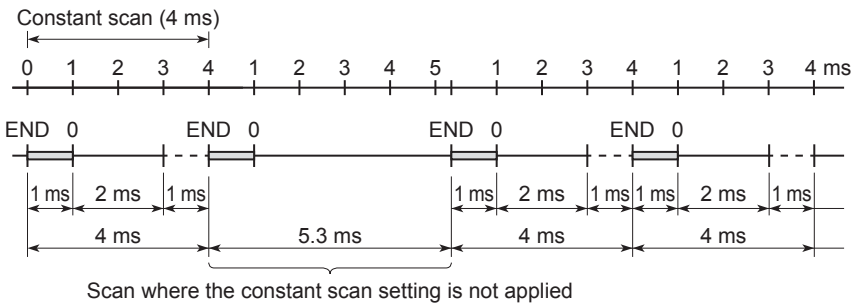

## Wait time from the execution of END process until the beginning of the next scan

When there is a processing mentioned below requested during wait time, the processing of the program is interrupted and the corresponding process is carried out.

- Interrupt program
- Fixed scan execution type program
- Event execution type program which triggers the generation of interruption
- Device/label access service processing

# 14 REMOTE OPERATION

A remote operation is an operation to externally change the operation status of the CPU module with the RUN/STOP/RESET switch of the CPU module set to the RUN position.

The following items show the types of remote operation.

- Remote RUN/STOP
- Remote PAUSE
- Remote RESET

## 14.1 Remote RUN/STOP

This operation externally changes the CPU module to RUN/STOP status with the RUN/STOP/RESET switch of the CPU module set to the RUN position. It is used to reach a CPU module in an inaccessible place or in case of changing the status of the CPU module in the control box to RUN/STOP status with an external signal.

### Applications of remote RUN/STOP

It is usable in the following cases.

- When the CPU module is in an inaccessible place
- When changing the status of the CPU module in the control box to RUN/STOP from outside

### Operation during remote RUN/STOP

In case of remote RUN/STOP, the operation of the program is as shown below.

#### At remote STOP

A program is executed up-to END instruction and changes to STOP status.

#### At remote RUN

When remote RUN is executed in the STOP status, once again the CPU module turns to RUN status and the program is executed from step 0.

### Method of execution of remote RUN/STOP

The following are the methods of execution of remote RUN/STOP.

#### Contact method

Set the RUN contact in the parameter. The allowable device range is X0 to X17.

Execute remote RUN/STOP by contact ON/OFF. Set the correspondence of ON/OFF and RUN/STOP operation of the contact in CPU parameters.

- When set to RUN at contacts ON

When contact is set to OFF, the CPU module is in the STOP status.

When contact is set to ON, the CPU module is in the RUN status.

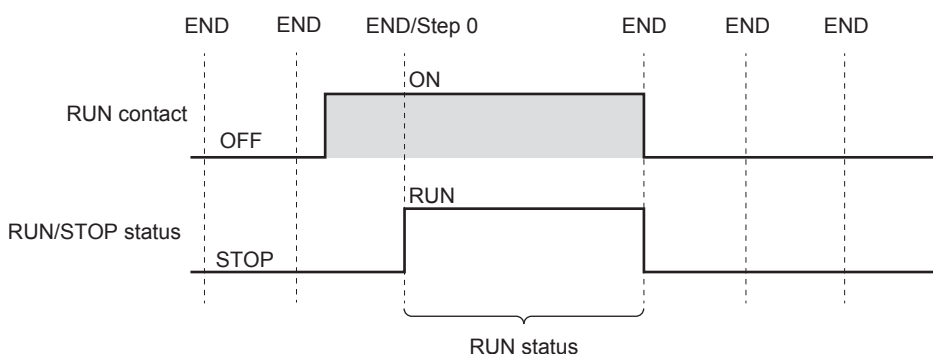



- When set to RUN at contacts OFF

When contact is set to OFF, the CPU module is in the RUN status.

When contact is set to ON, the CPU module is in the STOP status.

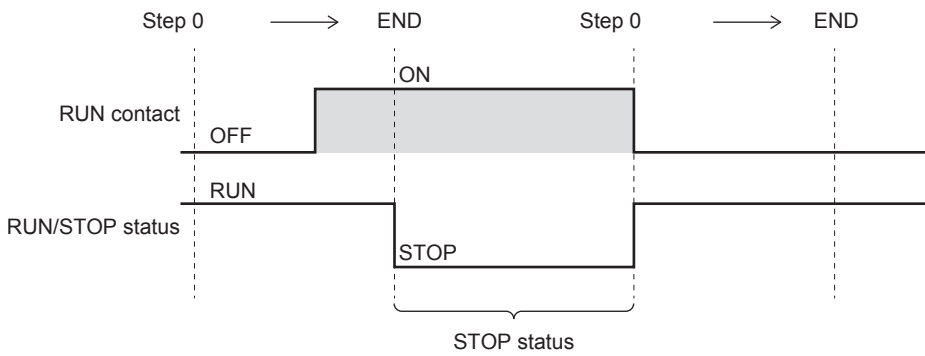

## Engineering tool method

Refer to the following.

📖 GX Works3 Operating Manual

## Method using external devices that use SLMP or MC protocol

Execute by SLMP or MC protocol 1C/3C/4C frame command. For details on commands, refer to the following manual.

📖 MELSEC iQ-F FX5 User's Manual (Communication)

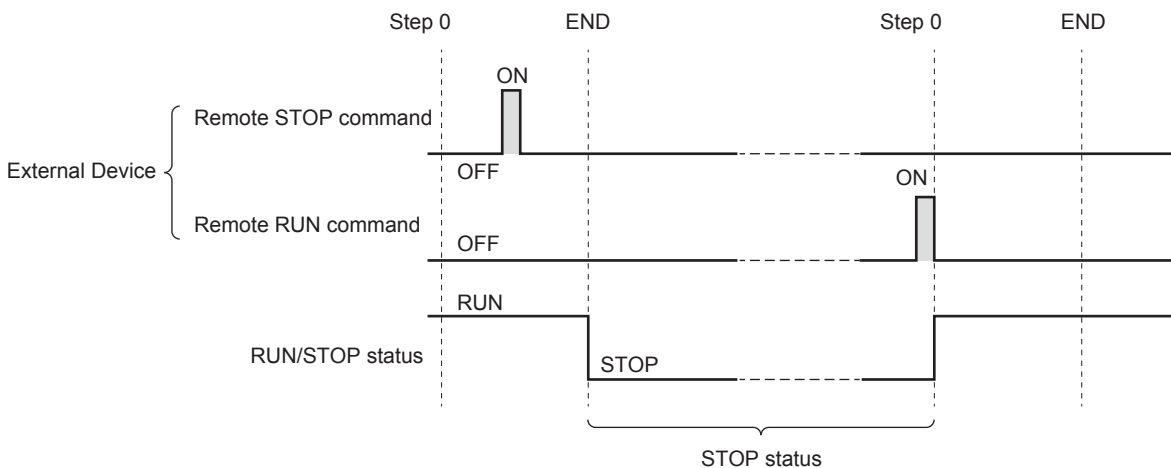

## Precautions

Describes the precautions on using remote RUN/STOP.

- When remote RUN is performed during execution of the data logging function, it may fail. In that case, wait for a while and retry remote RUN. If remote RUN still cannot be executed, check whether remote RUN is acceptable and retry remote RUN. (📖 Page 192 About remote operation)
- When remote STOP to RUN operation of the RUN contact during execution of the data logging function, it may take time to return to the RUN state.

## 14.2 Remote PAUSE

With the RUN/STOP/RESET switch set to the RUN position of the CPU module, the operation status is changed to PAUSE status from outside. The PAUSE status is a status in which operation of the CPU module is stopped by holding the ON/OFF status of all output (Y).

### Application of remote PAUSE

Remote PAUSE can be used to hold the output (Y) turned ON when the CPU module is in the RUN status, in the same ON status, even when the CPU module is changed to STOP status.

### Method of execution of remote PAUSE

The following are the methods of execution of remote PAUSE.

#### Engineering tool method

Refer to the following.

📖 GX Works3 Operating Manual

#### Method using external devices that use SLMP or MC protocol

Execute by SLMP or MC protocol 3C/4C frame command. For details on commands, refer to the following manual.

📖 MELSEC iQ-F FX5 User's Manual (Communication)

- Turns ON the PAUSE contact (SM204) when executing the END process of the scan that has received the remote PAUSE command. When a PAUSE contact is turned ON and the next scan is executed up-to the END process, the CPU module enters the PAUSE status and operation is stopped.
- When a remote RUN command is received, once again an operation of the sequence program is executed from step 0.

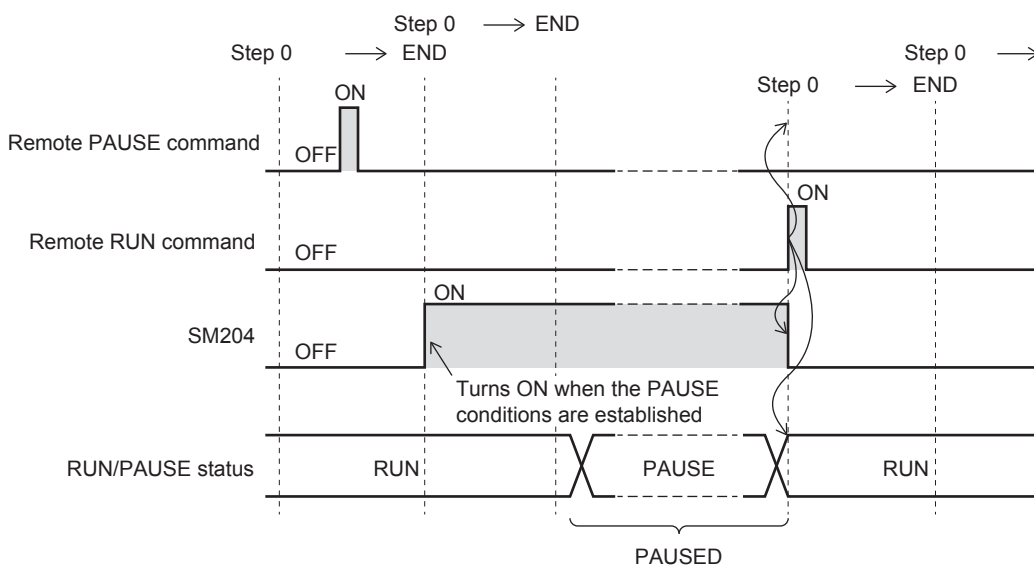

## Precautions

### ■When keeping in forced ON or OFF status in advance

When keeping in forced ON or OFF status in advance, interlock using the PAUSE contact (SM204).

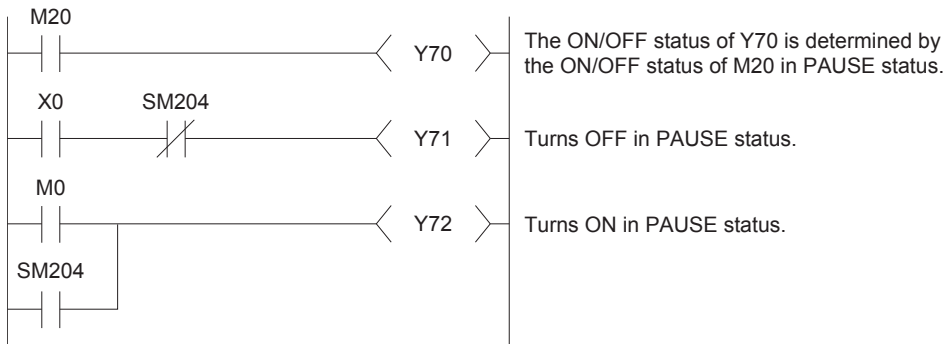

## 14.3 Remote RESET

This is an operation to reset the CPU module by an external operation when the CPU module is in the STOP status. In addition, even if the RUN/STOP/RESET switch of the CPU module is set to RUN position, reset is possible when the CPU module has stopped due to occurrence of an error that can be detected by self-diagnosis function.

14

### Application of remote RESET

When a CPU module is in an inaccessible place and an error has occurred, CPU module can be reset by a remote operation.

### Enabling remote RESET

To remotely RESET, remote RESET must be enabled.

Navigation window ⇒ [Parameter] ⇒ [Module model name] ⇒ [CPU Parameter] ⇒ "Operation Related Setting" ⇒ "Remote Reset Setting"

#### Window

Item	Setting
<b>Remote Reset Setting</b>	
Remote Reset	Disable

#### Displayed items

Item	Description	Setting range	Default
Remote Reset	Set whether or not to enable remote RESET.	<ul style="list-style-type: none"> <li>Disable</li> <li>Enable</li> </ul>	Disable

### Method of execution of remote RESET

The following are the methods of execution of remote RESET.

#### Engineering tool method

Refer to the following.

📖 GX Works3 Operating Manual

## Method using external devices that use SLMP or MC protocol

Execute by SLMP or MC protocol 3C/4C frame command. For details on commands, refer to the following manual.

 MELSEC iQ-F FX5 User's Manual (Communication)

### Point

When executing remote RESET, the settings that allow the remote reset of the CPU parameter must be written to CPU module beforehand. In the case that they are not set, remote RESET will not be possible.

## Precautions

### ■ Remote RESET in RUN status

When the CPU module is in RUN status, it cannot be reset by remote RESET. Change the CPU module to STOP status by operations like remote STOP and then execute remote RESET.

### ■ State after completion of the reset process

When the reset process is completed on a CPU module on which remote RESET was executed, the CPU module will change to an operation status set by the RUN/STOP/RESET switch. Setting the RUN/STOP/RESET switch to the STOP position, will change the status to STOP and setting the switch to the RUN position will change the status to RUN.

### Point

- Note that if a remote RESET is executed when the CPU module has stopped due to an error, the CPU module will change to an operation status set by the RUN/STOP/RESET switch, by reset process completion.
- If status of CPU module does not change even after executing remote RESET by engineering tool, check the remote reset settings in the CPU parameter. If it is not set, even after completion of the remote process of engineering tool, reset process of the CPU module will not be carried out.

### ■ When an error occurs due to noise

When an error occurs in the CPU module due to noise, exercise caution as there is a possibility that the CPU module cannot be reset by remote RESET. When reset by remote RESET is not possible, either execute reset by RUN/STOP/RESET switch or once again start up the power of CPU module.

# 14.4 Relationship Between Remote Operation and CPU Module

## Relationship between remote operation and RUN/STOP status of the CPU module

The following table shows operation status of the CPU module by the combination of remote operation and RUN/STOP status of the CPU module.

Switch RUN/STOP status	Remote operation			
	RUN <sup>*1</sup>	STOP	PAUSE	RESET <sup>*2</sup>
RUN	RUN	STOP	PAUSE	Operation not possible <sup>*3</sup>
STOP	STOP	STOP	STOP	RESET <sup>*4</sup>

\*1 When executing by the RUN contact, setting of RUN contact is required in the CPU parameter.

\*2 Remote reset setting is required in the CPU parameter.

\*3 When a CPU module is changed to STOP status by a remote operation, remote reset is possible.

\*4 Includes even the cases where CPU module has stopped due to an error.

# 15 LATCH FUNCTION

The contents of each device/label of the CPU module is cleared in the cases described below and changed to its default value.

- At power OFF→ON of the CPU module
- At reset
- A power failure that exceeded allowable momentary power interruption

The contents of each device/label with latch setting will be maintained in case of power failure even in the above-mentioned cases. Therefore, when the data is managed by continuous control, even if power of the CPU is turned OFF or there is a power failure that exceeds the allowable momentary power interruption, all data can be maintained and control can be continued.

## 15.1 Types of Latch

There are two types of latches, latch (1) and latch (2).

Latch clear range can be set by selecting latch (1) or latch (2).

For latch clearing, refer to  Page 126 Clearing of Data of the Latch Range.

## 15.2 Device/label that can be Latched

The devices and labels that can be latched are described below.

### The devices that can be latched

The devices that can be latched are described below.

#### ■FX5S CPU module

Device	Specification Method	Applicable latch type
Internal relay (M)	Specify the latch range	Latch (1) or Latch (2)
Latch relay (L)	Specify the number of points	Latch (1) or Latch (2)
Link relay (B)	Specify the latch range	Latch (1) or Latch (2)
Annunciator (F)	Specify the latch range	Latch (1) or Latch (2)
Step relay (S)	Specify the latch range	Latch (1) only
Timer (T)/Accumulation timer (ST)	Specify the latch range	Latch (1) or Latch (2)
Accumulation timer (ST)	Specify the latch range	Latch (1) or Latch (2)
Counter (C)/Long counter (LC)	Specify the latch range	Latch (1) or Latch (2)
Data register (D)	Specify the latch range	Latch (1) or Latch (2)
Extended file register (ER)	The latch setting is not required because extended file register (ER) is the device held only in the SD memory card. (All latch points fixed)	—

#### ■FX5UJ CPU module

Device	Specification Method	Applicable latch type
Internal relay (M)	The latch range is fixed. The latch range cannot be changed.	Latch (1) only
Latch relay (L)	The latch range is fixed. The latch range cannot be changed.	Latch (1) only
Annunciator (F)	The latch range is fixed. The latch range cannot be changed.	Latch (1) only
Step relay (S)	The latch range is fixed. The latch range cannot be changed.	Latch (1) only
Accumulation timer (ST)	The latch range is fixed. The latch range cannot be changed.	Latch (1) only
Counter (C)/Long counter (LC)	The latch range is fixed. The latch range cannot be changed.	Latch (1) only
Data register (D)	The latch range is fixed. The latch range cannot be changed.	Latch (1) only
Extended file register (ER)	The latch setting is not required because extended file register (ER) is the device held only in the SD memory card. (All latch points fixed)	—

## ■FX5U/FX5UC CPU module

Device	Specification Method	Applicable latch type
Internal relay (M)	Specify the latch range	Latch (1) or Latch (2)
Latch relay (L)	Specify the number of points	Latch (1) or Latch (2)
Link relay (B)	Specify the latch range	Latch (1) or Latch (2)
Annunciator (F)	Specify the latch range	Latch (1) or Latch (2)
Step relay (S)	Specify the latch range	Latch (1) only
Timer (T)/Accumulation timer (ST)	Specify the latch range	Latch (1) or Latch (2)
Counter (C)/Long counter (LC)	Specify the latch range	Latch (1) or Latch (2)
Data register (D)	Specify the latch range	Latch (1) or Latch (2)
Link register (W) <sup>*1</sup>	Specify the latch range	Latch (1) or Latch (2)
File register (R) <sup>*1</sup>	Specify the latch range	Latch (1) or Latch (2)
Extended file register (ER)	The latch setting is not required because extended file register (ER) is the device held only in the SD memory card. (All latch points fixed)	—

\*1 Link register (W) and file register (R) can be latched only when an optional battery is used.

### Labels that can be latched

The labels that can be latched are described below.

Label	Type	Attribute	Data type
Global label	VAR_GLOBAL	RETAIN	Basic data type, array, structure
Local label of the program block	VAR		
Local label of the Function Block	VAR		
	VAR_OUTPUT		
	VAR_PUBLIC		

## 15.3 Latch Settings

### Latch settings

This subsection describes the latch setting.

This format is supported by the FX5S and FX5U/FX5UC CPU modules.

#### Setting latch on devices

A range of multiple latches can be set for 1 type of device. Two latch ranges, latch (1) and latch (2), can be set. However, make sure that the range of latch (1) and latch (2) is not overlapping.

## ■ Latch range setting

Set the device to latch, its range, and the latch type.

### Operating procedure

"Device Setting" window

Item	Symbol	Device		Latch (1)	Latch (2)
		Points	Range		
Input	X	1024	0 to 1777		
Output	Y	1024	0 to 1777		
Internal Relay	M	7680	0 to 7679	Setting	No Setting
Link Relay	B	256	0 to FF	No Setting	No Setting
Special Link Rela	SB	256	0 to FF		
Annunciator	F	128	0 to 127	No Setting	No Setting
Step Relay	S	4096	0 to 4095	Setting	
Timer	T	512	0 to 511	No Setting	No Setting
Retentive Timer	ST	16	0 to 15	Setting	No Setting
Counter	C	256	0 to 255	Setting	No Setting
Long Counter	LC	64	0 to 63	Setting	No Setting
Data Register	D	8000	0 to 7999	Setting	No Setting
Latch Relay	L	7680	0 to 7679		
Total Device			11.1K Word		9.6K Word
Total Word Device			10.2K Word		8.1K Word
Total Bit Device			15.7K Bit		25.1K Bit

"Latch Range Setting" window

Latch (1)		Latch (2)				
No.	Device	Points (Decimal)	Start	End		
1	M	7180	500	7679		
2	S	3596	500	4095		
3	ST	16	0	15		
4	C	100	100	199		
5	LC	44	20	63		
6	D	7800	200	7999		
7						
8						
9						
10						
11						
12						
13						

1. Click "Detailed Setting" on the "Device Setting" window.
2. In the "Device Setting" window, select the type of latch for the target device. The "Latch Range Setting" window is displayed.

Navigation window ⇒ [Parameter] ⇒ [Module model name] ⇒ [CPU Parameter] ⇒ "Memory/Device Setting" ⇒ "Device/Label Memory Area Detailed Setting" ⇒ "Device Setting" ⇒ "Detailed Setting"

3. Check the tab for the latch type, select the device to set and set the latch range (Start, End).

15

## Setting latch on labels

This subsection describes latch setting on labels.

### Operating procedure

Label edit window

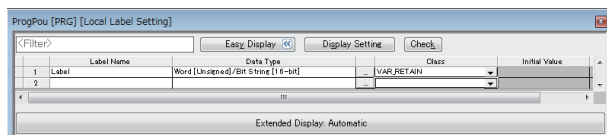

"Device/Label Memory Area Detailed Setting" window

Item	Setting
<b>Device/Label Memory Area Detailed Setting</b>	
Device (high speed) Setting	<Detailed Setting>
Device (Standard) Setting	<Detailed Setting>
Latch type setting of the latch relay (L)	Latch (1)
Latch Label Latch Type	Latch (1)
Latch area of the latch label	Standard Latch Area

1. In the label edit window, specify "RETAIN" for label attribute.

2. There are two types of latch for labels: latch (1) and latch (2). Select one. The selected latch type is applied to all labels of with latch attribute.

Navigation window ⇒ [Parameter] ⇒ [Module model name] ⇒ [CPU Parameter] ⇒ "Memory/Device Setting" ⇒ "Device/Label Memory Area Detailed Setting" ⇒ "Latch Label Latch Type"

# 15.4 Clearing of Data of the Latch Range

The data of the latch range can be cleared by the following ways.

## Method of latch clearing

By using engineering tools. (📖GX Works3 Operating Manual)

🔗 [Online] ⇔ [CPU memory operation]

The range cleared can be selected by performing CPU memory operation.

- Clear the devices outside the latch range.
- Clear the devices outside the latch range and the devices within the range of latch (1).
- Clear the devices outside the latch range, the devices within the range of latch (1) and the devices within the range of latch (2).

## Method of clearing by program

### ■Clearing by program

Execute an RST command to a latched device or clear by sending K0 in MOV/FMOV instructions.

### ■Clearing by special relay (SM8031 or SM8032)

- SM8031: Clear the devices outside the latch range.
- SM8032: Clear the range of latch (1) and the range of latch (2).

# 15.5 Precautions

The precaution to be taken when using a latch function is described below.

- When latch range and device no. of points are changed in the parameter, the latching for devices other than link register (W) and latch label will be the same as the latch settings before the change. Also, if the latch range setting parameter at the time of previous operation is different from that at the time of the current operation after the CPU module is powered OFF and ON or reset, the latch data is recovered only in the overlapping part of the latch ranges.
- When latch range and the number of devices are changed in the parameter, all latch labels are cleared to "0".
- When the CPU parameter, program file, FB file, and global label setting file are changed, all latch labels are cleared to "0". However, when SM9353 (clear/keep of latch labels during PC write) is ON, even if the program file, FB file, and global label setting file are changed, latch labels are not cleared.\*<sup>1</sup>
- Special relays and special registers are not cleared even by performing CPU memory operation or special relay clearing.
- Extended file register (ER) cannot be cleared by special relays (SM8031, SM8032). Use ERINIT instruction, and data batch initialization (clearing values/memory initialization) function of GX Works3 when you clear an extended file register (ER). (📖 Page 66 Extended file register (ER) function)

\*1 To keep the data of latch label, turn on SM9353 before changing the files. Note that SM9353 can back up the setting in the event of a power interruption, and the setting can be backed up once SM9353 is turned on.  
For supported version of SM9353 (clear/keep of latch labels during PC write), refer to 📖 Page 966 Added and Enhanced Functions.



# 16 RAS FUNCTIONS

## 16.1 Self-Diagnostics Function

Checks if a problem exists with the CPU module.

### Self-diagnostics timing

If an error occurs when the CPU module is powered on or while it is in the RUN/STOP state, the CPU module detects, and displays it, and stops operation. However, depending on the error occurrence status or the instruction to execute, the CPU module may not be able to detect the error. Configure safety circuits external to the PLC to ensure that the entire system operates safely even in such a case.

### Check method of error

This section describes the check methods when error occurs.

#### Check method using special relay and special register

When the CPU module detects an error, it turns SM0 (Latest Self-diagnostics error (annunciator on included)) and SM1 (Latest Self-diagnostics error (annunciator on not included)) on and stores the error code corresponding to the error definition in SD0 (diagnostics error). If multiple errors are detected, the latest error code is stored in SD0. Use SM0, SM1, and SD0 on the program for the CPU module or mechanical interlock. Besides, the error code up to 16 pieces for the error contents being currently generated will be stored into SD10 (Self-diagnostics error code) to SD25 (Self-diagnostics error code). (The error code for the error content of 17th piece on and after will not be stored.)

#### Check method using LED

The error occurrence conditions can be checked through the lighting conditions of ERR LED. For details, refer to the following manual.

 MELSEC iQ-F FX5S/FX5UJ/FX5U/FX5UC User's Manual (Hardware)

#### Check method using the engineering tool

The error or event history being currently generated can be checked in the Module diagnostics window. ( GX Works3 Operating Manual)

#### ■Existing errors

Up to 16 errors (description of errors) currently existing in the CPU module can be displayed. However, even when an additional error occurs after a stop error, the error information is not refreshed.

#### Point

The maximum number of displayable errors is 15 for continuation errors and 1 for stop errors. When 15 continuation errors are displayed and another one occurs, description of the new error is not displayed. Also, when an error with the same code has already been displayed, the date and time of occurrence and detailed information of the relevant error are not updated.

#### ■Error history

Occurred errors is logged in the event history ( Page 130 Event History Function)

The event history is updated only when a battery error occurs, independent of the operating status of the CPU module. Also, when a battery error is detected after the occurrence of a stop error, the information on existing errors is not refreshed, and only the event history is updated.

# CPU module operation upon error detection setting

Configure each CPU Module Operation setting when an error is detected.

## Error detection setting

Sets whether or not to detect errors.

Navigation window ⇒ [Parameter] ⇒ [Module model name] ⇒ [CPU Parameter] ⇒ "RAS Setting" ⇒ "Error Detections Setting"

### Window

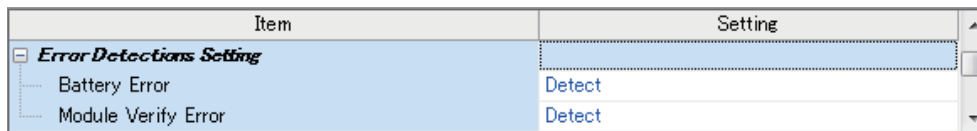

### Displayed items

Item	Description	Setting range	Default
Battery Error <sup>*1</sup>	Sets whether or not to detect the battery error.	<ul style="list-style-type: none"> <li>• Detect</li> <li>• Not Detected</li> </ul>	Detect
Module Verify Error	Sets whether or not to detect the module verification error.	<ul style="list-style-type: none"> <li>• Detect</li> <li>• Not Detected</li> </ul>	Detect <sup>*2</sup>

\*1 Only FX5U/FX5UC CPU module is supported.

\*2 For the FX5S CPU module, fixed to "Detect".

## CPU module operation upon error detection setting

Sets the CPU module operation upon error detection.

Navigation window ⇒ [Parameter] ⇒ [Module model name] ⇒ [CPU Parameter] ⇒ "RAS Setting" ⇒ "CPU Module Operation Setting at Error Detected"

### Window

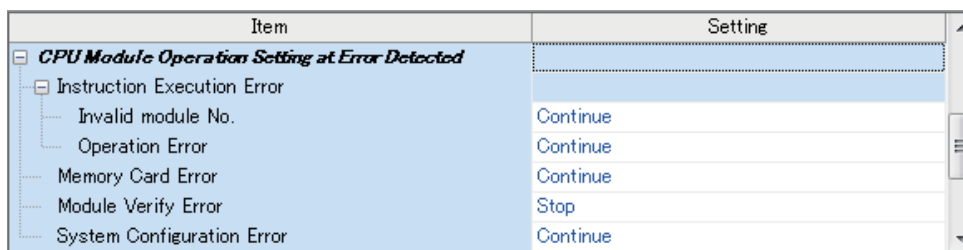

### Displayed items

Item	Description	Setting range	Default	
Instruction Execution Error	Invalid module No.	Sets the CPU module operation upon detection of an incorrect module No.	<ul style="list-style-type: none"> <li>• Continue</li> <li>• Stop</li> </ul>	Continue
	Operation Error	Sets the CPU module operation upon operation error.	<ul style="list-style-type: none"> <li>• Continue</li> <li>• Stop</li> </ul>	Continue
Memory Card Error	Sets the CPU module operation upon a memory card error.	<ul style="list-style-type: none"> <li>• Continue</li> <li>• Stop</li> </ul>	Continue	
Module Verify Error	Sets the CPU module operation upon a module verification error.	<ul style="list-style-type: none"> <li>• Continue</li> <li>• Stop</li> </ul>	Stop <sup>*1</sup>	
System Configuration Error	Sets the CPU module operation upon a system configuration error.	<ul style="list-style-type: none"> <li>• Continue</li> <li>• Stop</li> </ul>	Continue	

\*1 For the FX5S CPU module, fixed to "Stop".

## LED display setting

Set whether or not to display the ERROR LED and BATTERY LED.

Navigation window ⇒ [Parameter] ⇒ [Module model name] ⇒ [CPU Parameter] ⇒ "RAS Setting" ⇒ "LED Indication Setting"

### Window

Item	Setting
LED Display Setting	
ERROR LED	
Minor Error (Continue Error)	Display
BATTERY LED	
Battery Error	Display

### Displayed items

Item	Description	Setting range	Default	
ERROR LED	Minor Error (Continue Error)	Sets whether or not the ERROR LED is displayed when a minor error occurs.	• Display • Do Not Display	Display
BATTERY LED <sup>*1</sup>	Battery Error	Sets whether or not the BATTERY LED is displayed when a battery error occurs.	• Display • Do Not Display	Display

\*1 Only FX5U/FX5UC CPU module is supported.

## Error clear

This function clears all the existing continuation errors at once.

### Errors that can be cleared

Error code	Error name
1080H	ROM write count error
1090H	Battery error
1120H	SNTP clock setting error
1200H	Module moderate error detected
1800H	Annunciator ON
1810H, 1811H	Operation error
1900H	Constant scan time error
1920H	IP address setting error
1921H	IP address writing/clear request simultaneous detection
1FE0H to 1FE6H, 2008H	Module configuration error
2120H, 2121H	Memory card error
2400H	Module verification error
2440H, 2441H	Module major error
2450H	Module major error detected
2522H	Invalid interrupt
2801H	Module specification error
2820H, 2821H, 2822H, 2823H	Device specification error
2840H	File name specification error
3360H to 3362H	Nesting depth error
3380H	Pointer execution error
3400H to 3406H, 3420H, 3500H, 3502H to 3506H, 350AH, 350CH to 350FH, 3510H to 351EH, 3580H, 3581H, 3583H to 3588H, 3600H, 3611H to 361CH, 3621H to 362CH, 3631H to 363CH, 3641H to 364CH, 3651H to 365CH, 3661H to 366CH, 3671H to 367CH, 3681H to 368CH, 3691H to 369CH, 36A1H to 36ACH, 36B1H to 36BCH, 36F0H	Operation error
3780H	High-speed comparison table maximum excess error
3781H	Preset value range outside error

## How to clear errors

Errors can be cleared in two ways:

### ■Using the engineering tool

Clear errors with the module diagnostics function of engineering tool. (📖GX Works3 Operating Manual)

### ■Using SM/SD

Clear errors by operating SM/SD.

1. Check SD0 (Latest self-diagnostics error code) to identify what errors are detected.
2. Clear the cause of each of the currently detected continuation errors.
3. Turn off and on SM50 (error reset).

#### Point 🔍

When clearing the error with the error code (2400H), set "Continue" to "Module Verification Error" in "CPU Module Operation Setting at Error Detected". (👉 Page 128 CPU module operation upon error detection setting) However, SM61 (I/O module verify error) which is turned ON when the error code (2400H) occurs is not turned OFF. To turn OFF SM61, the CPU module must be turned ON or reset.

## Precautions

This section describes some precautions to take when using the error clear function:

- Since the function clears all of the currently detected continuation errors at once, errors that should not yet be cleared may be cleared.
- Use the RST instruction to reset each annunciator individually.

# 16.2 Event History Function

Information including errors detected in the CPU module, expansion board, expansion adapter and intelligent module, and errors that occur in the network is collected and saved by the CPU module. Once errors are stored, they can be checked chronologically. This function can be used to pinpoint the cause of faults that occur in the system or device.

For supported version of event history function, refer to 👉 Page 966 Added and Enhanced Functions.

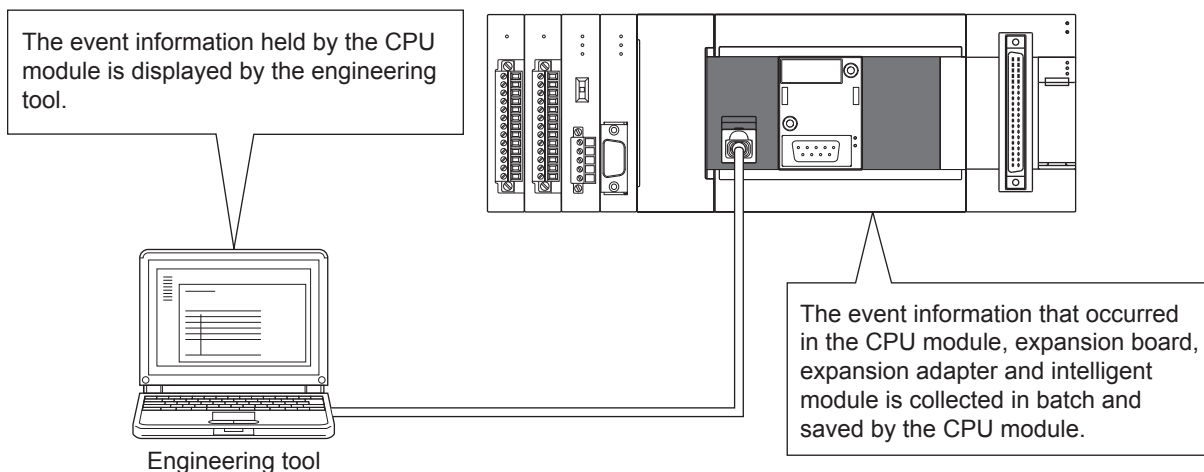

#### Point 🔍

The event history information is constantly collected regardless of the operating state of the CPU module. There are occasions, however, when the event history information cannot be collected due to a major error in a module, a cable failure, or some other cause.

# Event history settings

Under normal circumstances, the event history function can be used with its default settings and need not be manually configured. The storage memory and size settings for event history files can be changed as needed. (📖 Page 132 Event history file)

🔗 Navigation window ⇒ [Parameter] ⇒ [Module model name] ⇒ [CPU Parameter] ⇒ "RAS Setting" ⇒ "Event History Setting"

## Window

Item	Setting
Event History Setting	
Save Destination	Data Memory
Storage Capacity Setting per File	1.5 K Byte

## Displayed items

Item	Description	Setting range	Default
Save Destination	Specify the storage location of event history files.	<ul style="list-style-type: none"> <li>Memory Card</li> <li>Data Memory</li> <li>Built-in RAM Battery Keeping<sup>*1</sup></li> </ul>	Data Memory
Storage Capacity Setting per File	Specify the storage capacity per event history file.	<ul style="list-style-type: none"> <li>1 to 2048K bytes (Save Destination: Memory Card)<sup>*2</sup></li> <li>1.5K bytes (fixed) (Save Destination: Data Memory)</li> <li>1 to 64K bytes (Save Destination: Built-in RAM Battery Keeping)<sup>*1</sup></li> </ul> Unit: 1K bytes	1.5 K Byte

\*1 Only FX5U/FX5UC CPU module is supported.  
 \*2 For the FX5S/FX5UJ CPU modules, fixed to 2048K bytes.

### Point

An optional battery is required to use the built-in RAM battery keeping. For details, refer to the following.  
 📖 MELSEC iQ-F FX5S/FX5UJ/FX5U/FX5UC User's Manual (Hardware)

# Logging of the event history

This section describes events saving for the event history.

## Which event history information is collected

### ■Target modules

The events collected for the event history are those that occur in the CPU module and in the expansion board, expansion adapter and intelligent module connected to the CPU module.

### Point

The bus access errors that occur in the CPU module when the intelligent function module is connected are also collected to the event history.

### ■Target networks

Collection of event history for devices on a network supports only the built-in Ethernet port communication for the CPU module or intelligent function module. The communication status is a target for the event history.

## Events logged by the CPU module

Information logged in the event history includes errors initiator and other detailed information for troubleshooting purposes. For events that are logged in the event history on the CPU module, refer to 📖 Page 907 Event List.

## Event history file

The storage memory and file size for event history files can be changed in event history setting. (  Page 131 Event history settings)

### ■Storage memory

The following storage memory can be used.

- Data memory
- Built-in RAM battery keeping \*1
- Memory card (SD memory card)

\*1 Only FX5U/FX5UC CPU module is supported.

#### Point

For a system where the communication conditions are unstable and frequently change, the event history file size should be made large enough to accommodate a greater number of events. If this is the case, the SD memory card is highly recommended as the storage memory.

### Precautions

- If the storage memory is the built-in RAM battery keep: when the battery is not loaded or the battery voltage is low, if an operation such as power is turned OFF → ON or RESET operation is made, the generated error will not be stored into the event history.
- If the storage memory is a memory card (SD memory card), the event history will not be stored when the SD memory card's write protect switch is enabled. (The event history file in the SD memory card can be read with the engineering tool.) Thus, if the SD memory card's write protect switch is changed from disabled to enabled during operation, and an event that saves to the event history occurs, a write to SD memory card error will occur. (Immediately after the error occurs, it can be checked with the engineering tool's module diagnosis. However, the occurring error will not be saved in the event history after the power has been turned OFF and ON or the module reset, etc.)
- If the storage memory is the memory card (SD memory card): when the SD memory card is not loaded, after power is turned OFF → ON or after resetting operation, errors will not be stored into the event history.

### ■File size

The size for event history files can be changed in event history setting (  Page 131 Event history settings). If the storage size exceeds the specified size, records are deleted in order from the oldest one and the latest one is stored. An event history file size is obtained from the following calculation formula.

Event history file size = File header size + Event history management information size + (Number of records × Size per event history record)

Element	Size
File header size	20 bytes
Event history management information size	12 bytes
Size per event history record*1	40 to 1112 bytes (variable)

\*1 Because the contents of detailed information may differ depending on the event to be saved or the detailed information may include a variable-length file name, the size per event history record is variable.

The number of events to be saved in the event history file differs depending on the event type to be saved.

### ■When files are created

An event history file is created when:

- The CPU module is turned off and on (if there is no event history file or after the event history settings are changed).
- The CPU module is reset (if there is no event history file or after the event history settings are changed).
- Initialization of the SD memory card (when no event history file exists)<sup>\*1</sup>

\*1 When a parameter is stored in the data memory, the event history file is created on the SD memory card, according to the event history setting.

The following table shows how the event history is treated depending on operation.

Operation	Operation for the event history
Memory initialization	When this event occurs, the event history is stored into the internal memory. If the internal memory reaches the maximum number of event history records it can store, all subsequent events are lost (☞ Page 133 Loss of event history information)
Event history creation	The event history, which has been stored in the internal memory during absence of the event history file, is stored into the data memory or the SD memory card (If any event was lost, it is logged as "**HST.LOSS**").

Indicates the operation of the event history for the SD memory which was removed and mounted in the case that the save destination memory is the memory card (SD memory card).

Operation	Operation for the event history
Removal of the SD memory card	When this event occurs, the event history is stored into the internal memory. If the internal memory reaches the maximum number of event history records it can store, all subsequent events are lost (☞ Page 133 Loss of event history information)
Installation of the SD memory card	The event history, which have been stored in the internal memory during absence of the SD memory card, is stored to the SD memory card. If the re-inserted SD memory card contains an event history file of the same file size, the CPU module continues to store the event history information. If the file size is different, the CPU module removes the existing event history file and creates a new event history file.

### ■When parameters take effect

Any changed parameters take effect when:

- The CPU module is powered on
- The CPU module is reset

#### Point

Any changed parameters written in the storage memory with the CPU module in the STOP state does not take effect when the CPU module operating state is changed from STOP to RUN. In this case, the changed parameters will take effect the next time when the CPU module is turned off and on or reset.

### Loss of event history information

If events are detected frequently, some events may be lost without being collected. When event loss occurs, "\*\*HST.LOSS\*\*" appears in the "Event Code" field of the engineering tool.

## Viewing the event history

---

The event history can be viewed using the menus of the engineering tool. For operating procedures and how to interpret the displayed information, refer to the following:

 GX Works3 Operating Manual

## Clearing the event history

---

The event history can be cleared using the event history window. Once the event history is cleared, the CPU module deletes all the event history information stored in the specified storage memory. For operating procedures and other details, refer to the following:

 GX Works3 Operating Manual

## Precautions

---

### Clearing the event history during execution of another function

---

The event history cannot be cleared while executing the backup/restoration function. ( Page 208 DATA BACKUP/RESTORATION FUNCTION) Confirm that the backup/restoration function is not being executed before executing event history clear.

### Reading the event history during execution of another function

---

The event history cannot be read out while executing the restoration function. ( Page 217 Restoration Function) Confirm that the restoration function is not being executed before reading the event history.



# 17 EXTERNAL INPUT/OUTPUT FORCED ON/OFF FUNCTION

External inputs/outputs can be forcibly turned on and off from the engineering tool. This function enables input devices to be turned on and off regardless of the on/off state of the external inputs and enables the external outputs to be turned on and off regardless of the operation result of a program.

(External input)

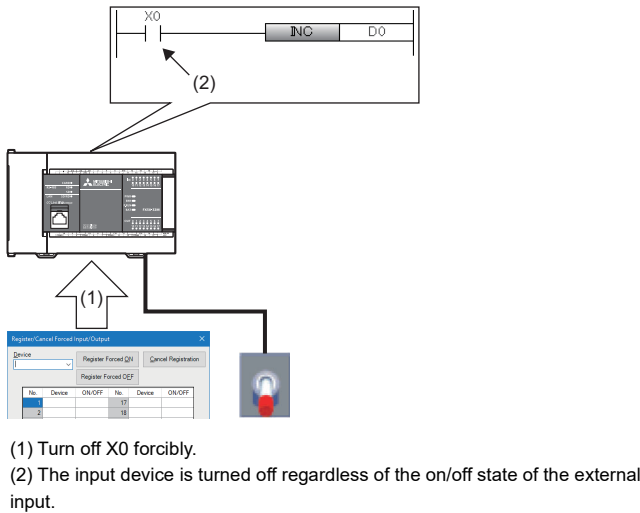

- (1) Turn off X0 forcibly.
- (2) The input device is turned off regardless of the on/off state of the external input.

(External output)

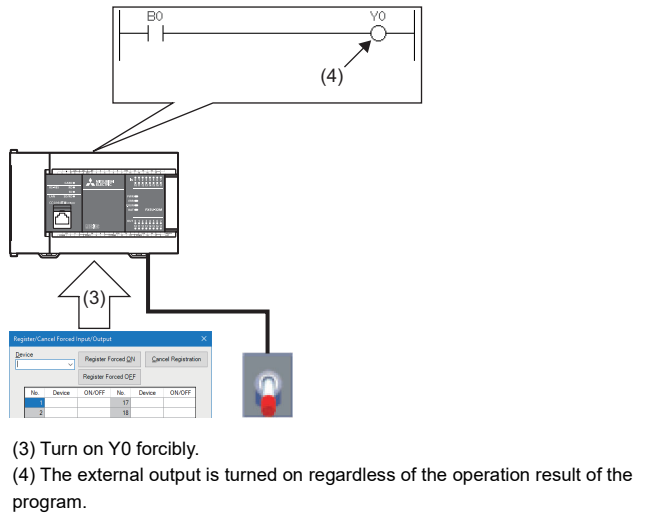

- (3) Turn on Y0 forcibly.
- (4) The external output is turned on regardless of the operation result of the program.

## Restriction

Before executing the external input/output forced on/off function, check the versions of the CPU module and engineering tool used. (Page 966 Added and Enhanced Functions)

## Devices that allow forced on/off registration

The following lists the devices that allow forced on/off registration.

Device	Range
Input	X0 to X1777
Output	Y0 to Y1777

## Number of device points that allows forced on/off registration

A maximum of 32 points can be registered for input devices and output devices in total.

## Inputs/outputs for which forced on/off can be set

The following describes the inputs/outputs for which forced on/off can be set.

### Input

After the refreshed data from the module is reflected, the input devices for which forced on/off registration is set are forcibly turned on or off.

### Output

The following external outputs are turned on or off by refreshing output devices that have been forcibly turned on or off.

- Refresh target output of CPU module and I/O module
- Link refresh target output of network modules
- Link refresh target output of CC-Link IE Field Network Basic

## Operation method of forced on/off

Use the engineering tool for the forced on/off operation.

 [Debug] ⇔ [Register/Cancel Forced Input/Output]

### Window

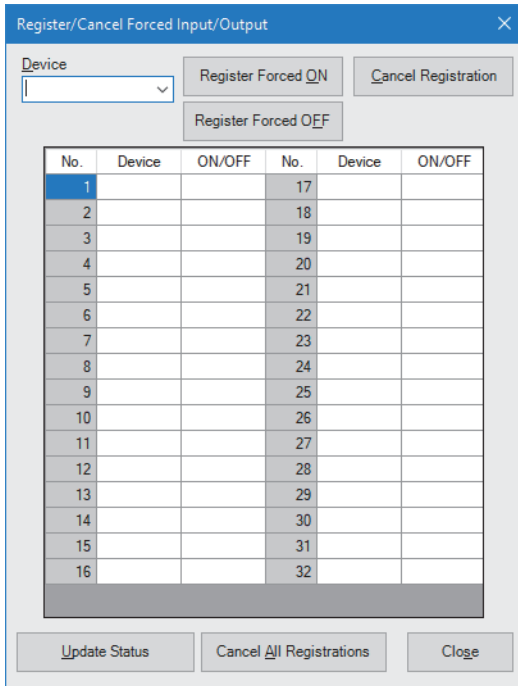

No.	Device	ON/OFF	No.	Device	ON/OFF
1			17		
2			18		
3			19		
4			20		
5			21		
6			22		
7			23		
8			24		
9			25		
10			26		
11			27		
12			28		
13			29		
14			30		
15			31		
16			32		

### Displayed items

Item	Description
Device	Enter target devices (X, Y).
[Register Forced ON] button	Registers forced on for the entered devices (X, Y).
[Register Forced OFF] button	Registers forced off for the entered devices (X, Y).
[Cancel Registration] button	Cancels forced on/off for the registered devices (X, Y).
[Update Status] button	Displays the latest on/off states.
[Cancel All Registrations] button	Batch-cancels forced on/off for the registered devices (X, Y).

## Behavior in forced on/off registration

The following describes the behavior in forced on/off registration.

### ■ Behavior of an input device

Registering forced on/off turns on or off the input device regardless of the status of the external input. When an input device for which the forced on/off has been registered is changed in the program, the input device is turned on and off in accordance with the operation result of the program.

Operation	Change in the input device in the program	Behavior of an input device
Forced on registration	Changed	<ul style="list-style-type: none"> <li>The input device is on when the program operation at every scan starts.</li> <li>The input device is turned on or off in accordance with the operation result of the program after the program operation at every scan started.*1</li> </ul>
	Not changed	The on state is held.
Forced off registration	Changed	<ul style="list-style-type: none"> <li>The output device is off when the program operation at every scan starts.</li> <li>The output device is turned on or off in accordance with the operation result of the program after the program operation at every scan started.*1</li> </ul>
	Not changed	The off state is held.

\*1 During monitoring, the value according to the forced on/off registration is monitored.

### ■ Behavior of an output device

Registering forced on/off turns on or off the external output regardless of the operation result of the program. When an output device has been changed in the program, the output device is turned on and off in accordance with the operation result of the program. Therefore, the on/off states between the output device and external output may differ.

Operation	Change in the output device in the program	Behavior of outputs	
		Behavior of an output device	Behavior of an external output
Forced on registration	Changed	<ul style="list-style-type: none"> <li>The output device is on when the program operation at every scan starts.</li> <li>The output device is turned on or off in accordance with the operation result of the program after the program operation at every scan started.<sup>*1</sup></li> </ul>	The external output is turned on regardless of the operation result of the program.
	Not changed	The on state is held.	
Forced off registration	Changed	<ul style="list-style-type: none"> <li>The output device is off when the program operation at every scan starts.</li> <li>The output device is turned on or off in accordance with the operation result of the program after the program operation at every scan started.<sup>*1</sup></li> </ul>	The external output is turned off regardless of the operation result of the program.
	Not changed	The off state is held.	

\*1 During monitoring, the value according to the forced on/off registration is monitored.

### CPU module operating status

Forced on/off registration is allowed regardless of the CPU module operating status. However, when a stop error has occurred, the output devices and external outputs are turned off regardless of the forced on/off registration setting. While the operating status of the CPU module is STOP due to a stop error, forced on/off is enabled only for the input devices. If the CPU module is powered off and on or is reset, all the forced on/off registration information will be canceled.

### Forced on/off timing

The following table lists the timing to reflect the registered data in the forced on/off registration settings to the input/output devices or external outputs.

Inputs/outputs for which forced on/off can be set	Reflection timing for the input devices	Reflection timing for the output devices or external outputs
FX5 CPU module input/output Input/output of input/output module, input module, and output module <sup>*1*2</sup>	<ul style="list-style-type: none"> <li>END processing (at input refresh)</li> <li>At program execution</li> <li>At instruction execution using the direct access input (DX) (LD, LDI, AND, ANI, OR, ORI, LDP, LDF, ANDP, ANDF, ORP, ORF, LDPI, LDFI, ANDPI, ANDFI, ORPI, ORFI)</li> <li>However, the registered data is not reflected to the input devices.<sup>*3</sup></li> <li>At execution of the RFS(P) instruction, REF(P) instruction, and MTR instruction</li> </ul>	<ul style="list-style-type: none"> <li>END processing (at output refresh)</li> <li>At program execution</li> <li>At instruction execution using the direct access output (DY) (OUT, SET, RST, PLS, PLF, FF, MC, SFT(P))</li> <li>At execution of the RFS(P) instruction, REF(P) instruction, and MTR instruction</li> </ul>
Input/output of the CPU module assigned to RX and RY of CC-Link <sup>*2</sup>	END processing (at link refresh)	
Input/output of the CPU module assigned to RX and RY of the CC-Link IE Field Network or CC-Link IE TSN <sup>*2</sup>	END processing (at link refresh)	
Input/output of the CPU module assigned to RX and RY of the CC-Link IE Field Network Basic	END processing (at link refresh)	
Input/output of the CPU module assigned to AnyWireASLINK system refresh settings <sup>*2</sup>	END processing (at link refresh)	
Input/output of the CPU module assigned to refresh settings of intelligent function module <sup>*2</sup> <ul style="list-style-type: none"> <li>Analog input module</li> <li>Analog output module</li> <li>Multiple input module</li> <li>Temperature control module</li> <li>Positioning module</li> <li>Simple motion module</li> <li>Motion module</li> </ul>	END processing (at link refresh)	
Input/output of the CPU module assigned to the simple CPU communication setting	END processing (at link refresh)	

\*1 High-speed input/output and part of the input/output used for positioning will not be affected by forced on/off. (  Page 139 Precautions)

\*2 Only the FX5UJ, FX5U, and FX5UC CPU modules are supported.

\*3 The operation of not changing the input device when executing an instruction (LD, LDI, AND, ANI, OR, ORI, LDP, LDF, ANDP, ANDF, ORP, ORF, LDPI, LDFI, ANDPI, ANDFI, ORPI, ORFI) using direct access input (DX) is the same as the existing operation.

## Checking the forced on/off execution status

The execution status of the forced on/off can be checked in the following ways.

### ■Engineering tool

The execution status can be checked with the [Update Status] button of the engineering tool. (  Page 136 Operation method of forced on/off)

### ■Special register

SD1488 (Debug function usage status) can be used to check whether the external input/output forced on/off function is used. (  Page 810 External input/output forced on/off function)

## Behavior in cancellation of forced on/off

Forced on/off registration can be canceled for each input/output device individually.

### ■Behavior of the device

Inputs/outputs for which forced on/off can be set		Change in input/output devices in the program	
		Changed	Not changed
Input	FX5 CPU module input Input of input/output module and input module <sup>*1</sup>	The input device is turned on or off in accordance with the on/off state of the modules.	
	Input from RX of CC-Link <sup>*1</sup>	The input device is turned on or off in accordance with the on/off state refreshed from CC-Link.	
	Input from RX of CC-Link IE Field Network or CC-Link IE TSN <sup>*1</sup>	The input device is turned on or off in accordance with the on/off state refreshed from CC-Link IE Field Network or CC-Link IE TSN.	
	Input from RX of CC-Link IE Field Network Basic	The input device is turned on or off in accordance with the on/off state refreshed from CC-Link IE Field Network Basic.	
	Input of the CPU module assigned to AnyWireASLINK system refresh settings <sup>*1</sup>	The input device is turned on or off in accordance with the on/off state refreshed from AnyWireASLINK system.	
	Input of the CPU module assigned to refresh settings of intelligent function module <sup>*1</sup>	The input device is turned on or off in accordance with the on/off state refreshed from the intelligent function module.	
	Input of the CPU module assigned to the simple CPU communication setting <sup>*2</sup>	The input device is turned on or off in accordance with the on/off state refreshed from the communication destination.	
	Input other than above (input without modules actually mounted)	The input device is turned on or off in accordance with operation result of the program.	The input device is turned on or off in accordance with the registered on/off state.
Output	FX5 CPU module output Output of input/output module and output module <sup>*1</sup>	The operation result of the program is output.	Data is output in accordance with the registered on/off state.
	Output to RY of CC-Link <sup>*1</sup>		
	Output to RY of CC-Link IE Field Network or CC-Link IE TSN <sup>*1</sup>		
	Output to RY of CC-Link IE Field Network Basic		
	Output to network module of AnyWireASLINK system <sup>*1</sup>		
	Output to intelligent function module <sup>*1</sup>		
	Output to the communication destination of the simple CPU communication <sup>*3</sup>		
	Output other than above (output without modules actually mounted)	The output device is turned on or off in accordance with operation result of the program. (Refresh to external output is not executed.)	The output device is turned on or off in accordance with the registered on/off state. (Refresh to external output is not executed.)

\*1 Only the FX5UJ, FX5U, and FX5UC CPU modules are supported.

\*2 Input from the communication partner is read into the input device and output device whose communication pattern is set to read.

\*3 Output to the communication partner is written from the input device and output device whose communication pattern is set to write.

### ■CPU module operating status

Forced on/off registration can be canceled regardless of the CPU module operating status.

## Behavior in batch-cancellation of forced on/off registrations

All the forced on/off registrations can be canceled in a batch.

### ■Behavior of the device

The behavior of the device is the same as that of cancellation of forced on/off (for each device). (☞ Page 138 Behavior of the device)

### ■CPU module operating status

The behavior of the device is the same as that of cancellation of forced on/off (for each device). (☞ Page 138 CPU module operating status)

## Precautions

The following describes precautions for using the external input/output forced on/off function.

- Multiple engineering tools connected to the network can be used to register forced on/off for the same CPU module. In this case, note the following.
  - The forced on/off state registered last is handled as the on/off state of input/output devices.
  - Since the on/off state displayed in engineering tools may differ from that of the CPU module, update the on/off state displayed in engineering tools.
- Execution of interrupt programs which are executed at a fixed scan may delay depending on the number of forced on/off registrations and the number of refresh points of each refresh processing.
- If the output device is registered as forced on/off and the all outputs disable flag (SM8034) has turned on, the all outputs disable flag has priority. Since the all outputs disable flag has priority, all output terminals will be turned off regardless of the forced on/off registration, and the forced on/off will only be reflected to the output device.
- For the RUN contact setting specified with the CPU parameter file, forced on/off becomes disabled because RUN/STOP is performed by an external signal.
- Reflection of forced on/off until 10ms has elapsed after a momentary power failure is the same as the existing operation.
 

When the input refresh disable flag (SM4488) turns on during momentary power failure

  - In the I/O refresh of END processing, the input device is not refreshed until 10ms has elapsed after the momentary power failure. Therefore, forced on/off is also not reflected.
  - For direct refresh (DX), the devices are refreshed to reflect the peripherals and enabled the forced on/off.
  - The output device is refreshed to reflect the forced on/off.
- If non-latch device clear (SM8031) has turned on, forced on/off will not be reflected.
- When the device batch clear or device/label memory batch clear is executed, the input/output device is cleared and forced on/off is reflected in the I/O refresh of END processing. For logging and memory dump, the value cleared for only one scan is collected.
- If the memory hold function (SM8033) is on, forced on/off will be reflected.
- When the CPU operating status changes from RUN to STOP or from PAUSE to STOP, the input/output device is cleared, and the forced on/off is reflected at I/O refresh of END processing. For memory dump, the value cleared for only one scan is collected.
- At execution of a high-speed input/output function simultaneously with the forced on/off function of the external input/output, the high-speed input/output function uses the external output, which reflects the forced on/off function while the output condition with the high-speed input/output function is not satisfied. Once the output condition with the high-speed input/output function is satisfied, the external output according to the specifications of the high-speed input/output function is executed.

Example 1:When Y0 is set for the output destination device of the high-speed comparison table function and forced off is registered for Y0

Before comparison match, forced off is reflected and Y0 becomes off. At the timing of the comparison match, Y0 outputs on, then at the timing of I/O refresh, the forced off is reflected again and Y0 returns to off.

Example 2:When Y0 is set for "(d) device numbers for which pulses are output" of the PWM instruction and forced on is registered for Y0

While the PWM instruction is being executed, pulses are output for Y0 by the PWM instruction, and forced off is not reflected.

Therefore, do not simultaneously execute the high-speed input/output function and the forced on/off function of the external input/output.

• The following table lists the high-speed input/output functions that have external outputs.

Function	Instruction	
High-speed counter function	High-speed I/O parameter	High-speed comparison table
		Multiple point output, high-speed comparison table
	32-bit data comparison set (DHSCS instruction)	
	32-bit data comparison reset (DHSCR instruction)	
32-bit data band comparison (DHSZ instruction)		
PWM function	High-speed I/O parameter	
	Pulse width modulation (PWM/DPWM instruction)	
Positioning control function	High-speed I/O parameter	
	Pulse output (PLSY/DPLSY instruction)	
	Mechanical OPR (DSZR/DDSZR instruction)	
	Relative positioning (DRVI/DDRVI instruction)	
	Absolute positioning (DRVA/DDRVA instruction)	
	Interrupt 1-speed positioning (DVIT/DDVIT instruction)	
	Variable speed operation (PLSV/DPLSV instruction)	
	Single-table operation (TBL instruction)	
	Multiple-table operation (DRVTBL instruction)	
	Multiple-axis table operation (DRVMUL instruction)	

# 18 CLOCK FUNCTION

The CPU module has an internal clock and is used to manage time in functions performed by the system such as dates of the event history function and the data logging function.

## 18.1 Time Setting

Time operation continues with the large internal capacitor in the CPU module even though the power in the CPU module is turned OFF or the power failure exceeds the allowable momentary power failure time.

If an optional battery is used in the FX5U/FX5UC CPU module, operation continues by the battery.

### Clock data

The clock data handled in the CPU unit is described below.

Data name	Description
Year	4 digits in calendar year (1980 to 2079)
Month	1 to 12
Day	1 to 31 (Leap year auto detect)
Hour	0 to 23 (24-hour system)
Minute	0 to 59
Second	0 to 59
Day-of-the-week	0: Sunday, 1: Monday, 2: Tuesday, 3: Wednesday, 4: Thursday, 5: Friday, 6: Saturday

### Changing the clock data

The clock data can be changed using the following methods.

- Using engineering tools
- Using SM/SD
- Using instructions

#### Using the engineering tool

Clock data can be changed using Set Clock from the menu. ([GX Works3 Operating Manual](#))

#### Using SM/SD

The values stored in SD210 (clock data) to SD216 (clock data) are written to the CPU module after END processing execution of scan when SM210 (clock data set request) is changed from OFF→ON. If the data from SD210 to SD216 is out of the valid range, SM211 (clock data set error) is turned ON, the values from SD210 to SD216 are not written in the CPU module.

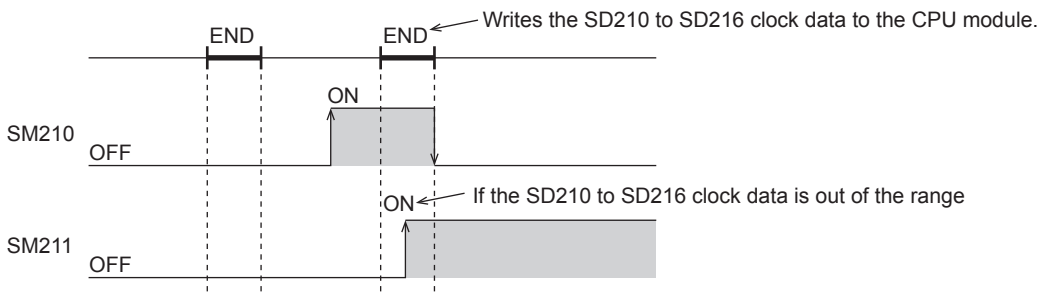

#### Using instructions

Writes the clock data to the CPU module, using the TWR(P) instruction. ([MELSEC iQ-F FX5 Programming Manual \(Instructions, Standard Functions/Function Blocks\)](#))

## Reading clock data

---

There are the following methods to read clock data.

- Using SM/SD
- Using instructions

### Using SM/SD

---

Clock data is read to SD210 to SD216 when SM213 (clock data read request) is turned ON.

### Using instructions

---

Clock data is read from the CPU module using the TRD(P) instruction. ([MELSEC iQ-F FX5 Programming Manual](#) (Instructions, Standard Functions/Function Blocks))

## Precautions

---

The following describes precautions when setting the time.

### When setting the clock for the first time

---

The clock is not set when the product is shipped.

### Correcting the clock data

---

Before correcting any part of the clock data, you must write all data into the CPU module again.



# 18.2 Setting Time Zone

The time zone used for the CPU module can be specified. Specifying the time zone enables the clock of the CPU module to work in the local time zone.

Navigation window ⇒ [Parameter] ⇒ [Module model name] ⇒ [CPU Parameter] ⇒ "Operation Related Setting" ⇒ "Clock Related Setting"

## Window

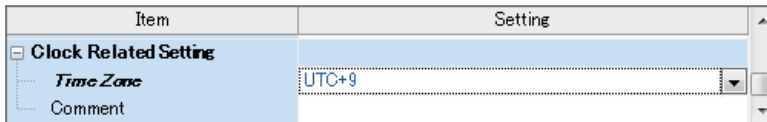

## Displayed items

Item	Description	Setting range	Default
Time Zone	Sets the time zone used by the CPU module.	<ul style="list-style-type: none"> <li>• UTC+13</li> <li>• UTC+12</li> <li>• UTC+11</li> <li>• UTC+10</li> <li>• UTC+9:30</li> <li>• UTC+9</li> <li>• UTC+8</li> <li>• UTC+7</li> <li>• UTC+6:30</li> <li>• UTC+6</li> <li>• UTC+5:45</li> <li>• UTC+5:30</li> <li>• UTC+5</li> <li>• UTC+4:30</li> <li>• UTC+4</li> <li>• UTC+3:30</li> <li>• UTC+3</li> <li>• UTC+2</li> <li>• UTC+1</li> <li>• UTC</li> <li>• UTC-1</li> <li>• UTC-2</li> <li>• UTC-3</li> <li>• UTC-3:30</li> <li>• UTC-4</li> <li>• UTC-4:30</li> <li>• UTC-5</li> <li>• UTC-6</li> <li>• UTC-7</li> <li>• UTC-8</li> <li>• UTC-9</li> <li>• UTC-10</li> <li>• UTC-11</li> <li>• UTC-12</li> </ul>	UTC+9
Comment	Enters a comment for the time zone (e.g., name of the city).	1 to 32 letters	—

### Point

To reflect the time zone setting on the CPU module, the module must be restarted. If no parameter is set for the CPU module (factory setting), it operates with "UTC+9".

## 18.3 System Clock

There are two types of system clocks, one is to execute ON/OFF by the system and the other is to execute ON/OFF in the intervals specified by the user.

### Special relay used for system clock

Special relays used for system clock are as follows.

Special relay	Name
SM400, SM8000	Always ON
SM401, SM8001	Always OFF
SM402, SM8002	After RUN, ON for one scan only
SM403, SM8003	After RUN, OFF for one scan only
SM409, SM8011	0.01 second clock
SM410, SM8012	0.1 second clock
SM411	0.2 second clock
SM412, SM8013	1 second clock
SM413	2 second clock
SM414	2n second clock
SM415	2n ms clock
SM8014	1 min clock
SM420, SM8330	Timing clock output 1
SM421, SM8331	Timing clock output 2
SM422, SM8332	Timing clock output 3
SM423, SM8333	Timing clock output 4
SM424, SM8334	Timing clock output 5

### Special register used for system clock

Special registers used for system clock are as follows.

Special register	Name
SD412	One second counter
SD414	2n second clock setting
SD415	2n ms clock setting
SD420	Scan counter
SD8330	Counted number of scans for timing clock output 1
SD8331	Counted number of scans for timing clock output 2
SD8332	Counted number of scans for timing clock output 3
SD8333	Counted number of scans for timing clock output 4
SD8334	Counted number of scans for timing clock output 5

#### Point

SM420 to SM424, SM8330 to SM8334, and SD8330 to SD8334 are used by the DUTY instruction. For the DUTY instruction, refer to the following.

 MELSEC iQ-F FX5 Programming Manual (Instructions, Standard Functions/Function Blocks)

# 19 SECURITY FUNCTIONS

These functions prevent theft, tampering, wrongful operation, illegal execution, etc. of a customer's assets saved on a personal computer or in modules in the FX5 system as a result of illegal access by a third party. Use of the security functions according to the following purposes.

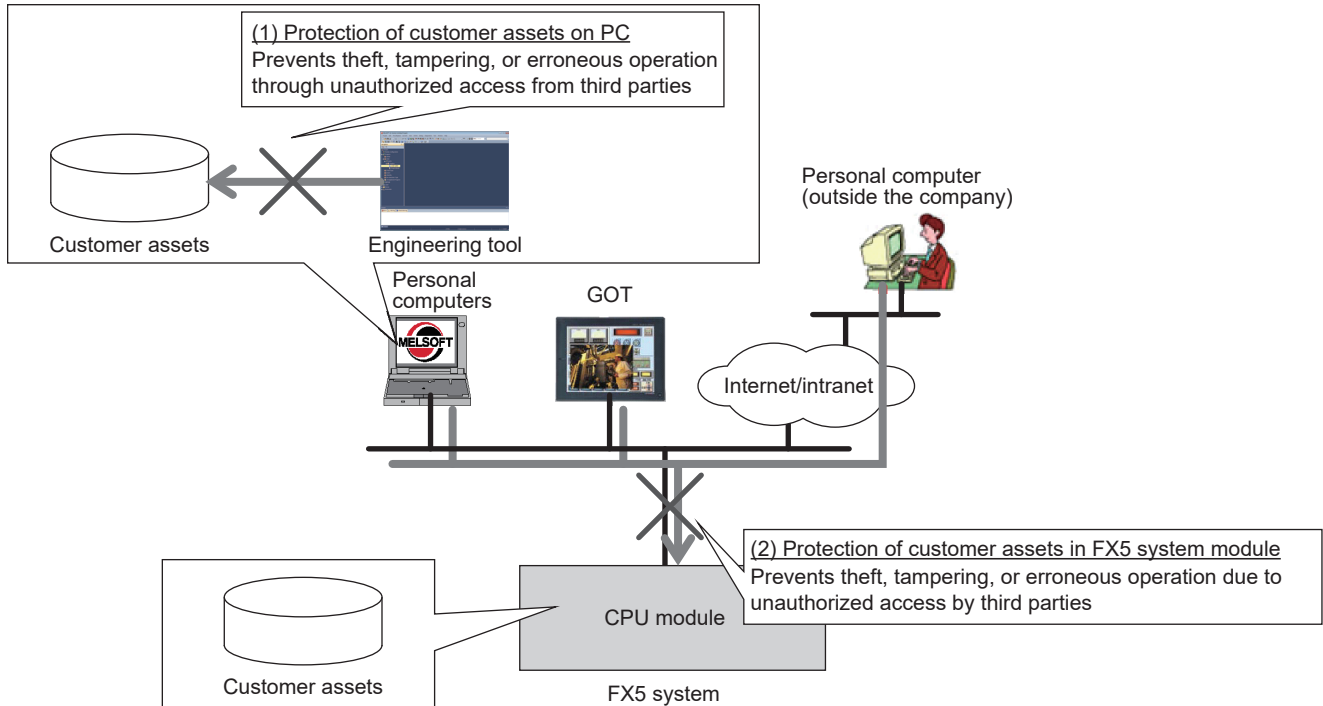

Data protection target	Purpose	Function	Reference
Projects	To prevent illegal accessing and viewing of programs (in program component units). (Password is used.)	Block password function	GX Works3 Operating Manual  MELSEC iQ-F FX5 User's Manual (Communication)  GX Works3 Operating Manual MELSEC iQ-F FX5 User's Manual (Communication)
	To prevent illegal accessing and viewing of programs (in program file units). (Security key is used.)	Security key authentication function	
CPU Module	To prevent illegal execution of programs. (Security key is used.)	File password function	
	To prevent illegal reading/writing of files. (Password is used.)		
	Blocks access from an invalid IP address by identifying the IP address of an external device via Ethernet.	IP filter function	
	To limit access from outside a specific communication path. (Password is used.)	Remote password function	

## Precautions

When a personal computer registered with a security key is misused by a third party, the outflow of program assets cannot be prevented. For this reason, the customer must adopt sufficient measures as explained below:

- Personal computer antitheft measures (using a wire lock, etc.)
- Management of personal computer users (deletion of unwanted accounts, strict control of login information, introduction of fingerprint authentication, etc.)

Also, when a personal computer registered with a security key malfunctions, locked project data cannot be accessed/viewed or edited. Mitsubishi Electric Corporation cannot be held responsible for any loss that may occur as a result of this with the customer, other individuals or organizations. For this reason, the customer must adopt sufficient measures as explained below:

- Export registered security keys and import them into another personal computer.
- Store files containing exported security keys in a safe location.

# MEMO

---

# 20 DATA LOGGING FUNCTION

The data logging function is a function that collects device, character string, and other data at specified intervals or timing, and stores such data as a data file.

From the CPU Module Logging Configuration Tool (free of charge), such items as target data, collection interval, and start condition can be set easily.

A data logging file is saved into an SD memory card as a CSV file or binary file.

A data logging file can be opened on a personal computer and used for such purposes as creating reports and analyzing data.

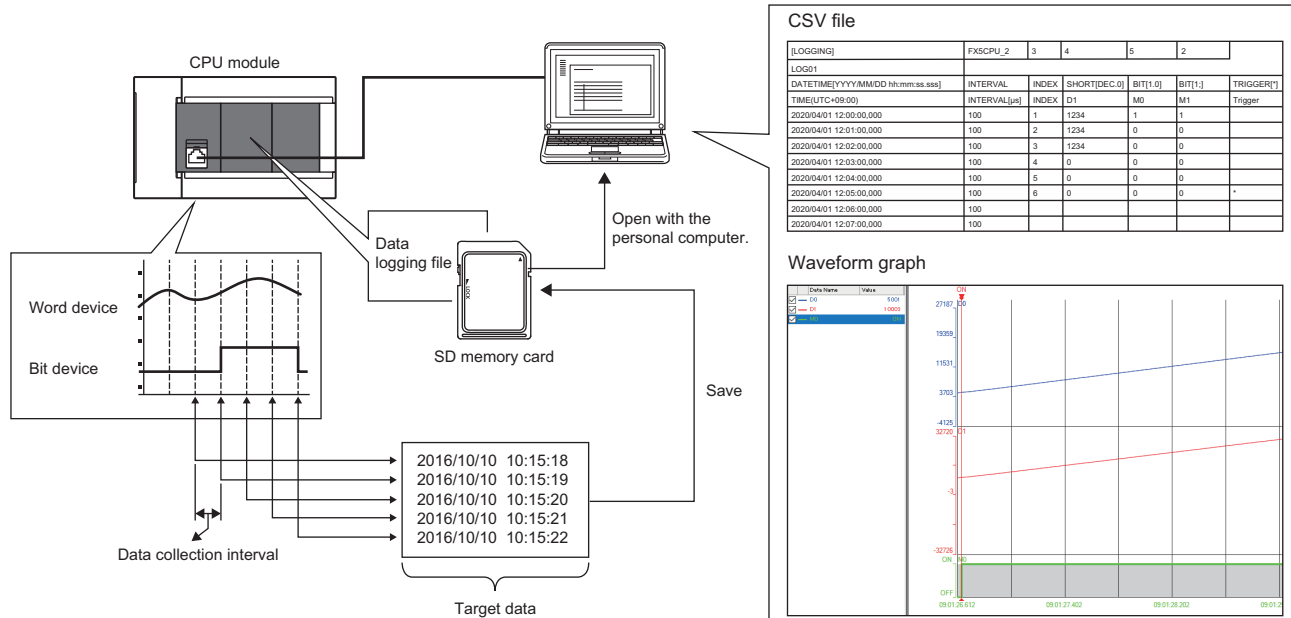

When using the data logging function, check the firmware version of the CPU module.

☞ Page 966 Added and Enhanced Functions

**Point**

By using the CPU Module Logging Configuration Tool (free of charge), the data logging function can be set easily (not via the program). The setting process is completed simply by entering data for the setting items according to the wizard window.

Simple setting using the wizard

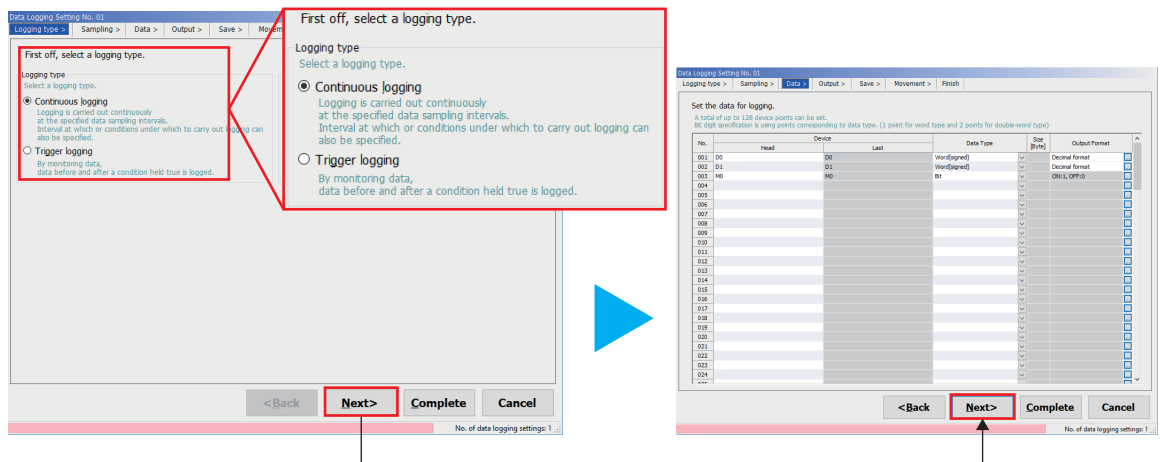

For the procedure for using the data logging function, refer to the following page.

☞ Page 150 Procedure for Using

# 20.1 Application Example

Two types of data logging functions are available: Continuous logging and trigger logging. Application examples are shown below.

## Continuous logging

Data can be collected at specified intervals and recorded. This enables facility and product data to be managed with time stamps for use to achieve traceability.

In addition, collected data logging files can be saved in CSV file format. A CSV file can be opened as a table and expected to be used for reports created by customers.

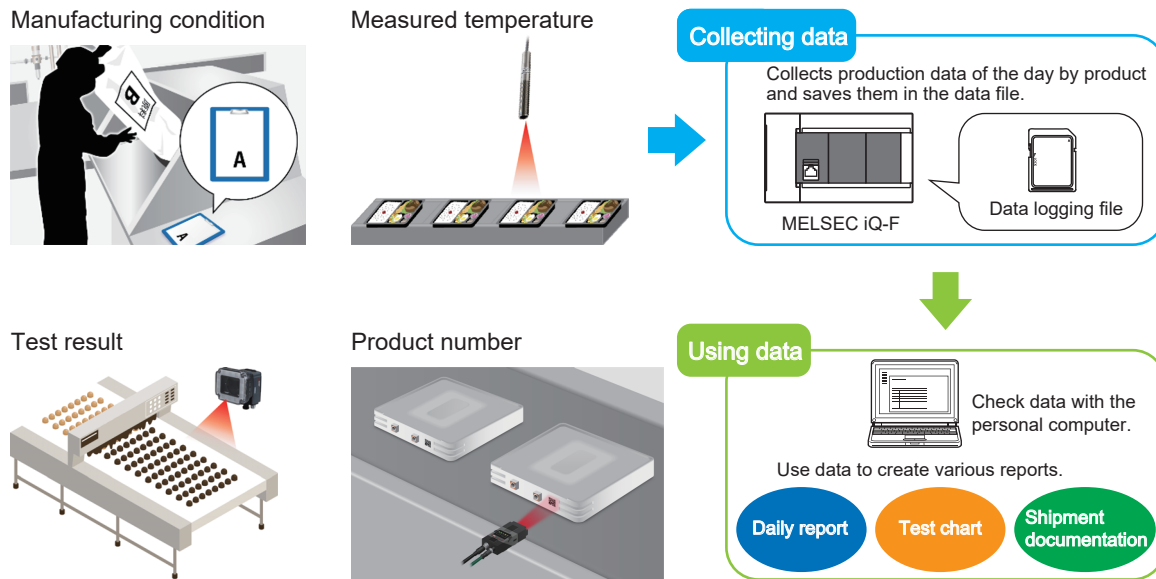

## Trigger logging

Data can be collected at a specified timing and a specified amount of data (a quantity of records) before and after the trigger condition is satisfied can be recorded.

For example, by specifying the device for facility error occurrence, only facility data before and after error occurrence can be saved as a data logging file. This enables data analysis when an error occurs to be performed efficiently.

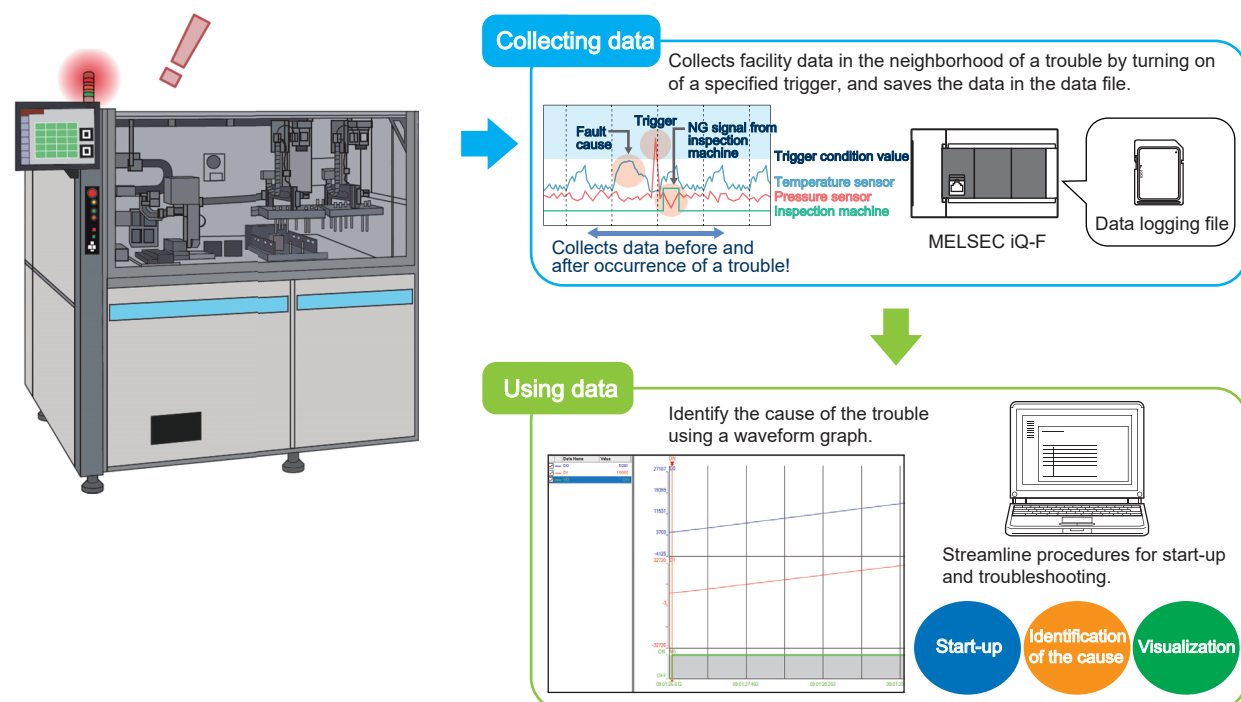

## 20.2 Specifications List

Describes the specifications of the data logging function.

Item		Specifications	Reference	
Number of data logging settings* <sup>1</sup>		4	—	
Data storage location		<ul style="list-style-type: none"> <li>Data memory (only data logging configuration file)</li> <li>SD memory card</li> </ul>	—	
Logging type		<ul style="list-style-type: none"> <li>Continuous logging</li> <li>Trigger logging</li> </ul>	Page 163 Logging type	
Data collection	Collection interval	<ul style="list-style-type: none"> <li>Each scanning cycle</li> <li>Time specification</li> <li>Condition specification (device specification)</li> </ul>	Page 165 Data collection conditions	
	Target data	Number of points for collection	Maximum of 512 (128 per setting)	
		Data type	<ul style="list-style-type: none"> <li>Bit</li> <li>Word (signed)</li> <li>Double word (signed)</li> <li>Word (unsigned)</li> <li>Double word (unsigned)</li> <li>Single-precision real number</li> <li>String</li> <li>Numeric string</li> <li>Time</li> </ul>	Page 168 Data type
Data processing	Trigger logging	Trigger condition	<ul style="list-style-type: none"> <li>Condition specification (device change specification)</li> <li>When trigger instruction executed</li> </ul>	Page 168 Trigger condition
		Trigger logging range	Number of records specified before and after the trigger establishment	Page 165 Number of records
		Number of trigger establishments (number of events that can be handled as trigger)	one	—
		Number of records	Maximum of 100000	—
	Processing time* <sup>2</sup>	Top speed of 10 ms (for 8 points × 1 setting)	Page 189 Precautions	
File output	File name		Add date + file number	Page 932 Save
	File storage format		<ul style="list-style-type: none"> <li>CSV file</li> <li>Binary file</li> </ul>	Page 169 Data logging file
	Data output format	CSV file	<ul style="list-style-type: none"> <li>Decimal format</li> <li>Hexadecimal format</li> <li>Decimal fraction format</li> <li>Exponential format</li> </ul>	Page 170 CSV file format
		Binary file	<ul style="list-style-type: none"> <li>Word (signed)</li> <li>Double word (signed)</li> <li>Word (unsigned)</li> <li>Double word (unsigned)</li> <li>Single-precision real number</li> </ul>	Page 172 Binary file format
Output file handling	Storage file switching	File switching timing	<ul style="list-style-type: none"> <li>Number of records</li> <li>File size</li> <li>Condition specification</li> </ul>	Page 177 File switching condition
		Maximum number of storage files	1 to 65535	Page 179 Storage file
Data logging file transfer function (FTP server auto transfer)		This function automatically transfers data logging files to the FTP server.	Page 181 Data logging file transfer function (FTP server auto transfer)	
Setting Behavior at the Time of Transition to RUN		This function sets data logging operations when entering into RUN mode after the data logging setting is registered.	Page 188 Setting the operation at the time of transition to RUN	

\*1 Number of settings where an item such as a data logging start condition or trigger can be registered at the same time. Devices for a maximum of 128 points can be registered per setting.

\*2 Processing time for which collection can be performed without losing data. Possible processing time differs depending on the number of points for collection (number of points × number of data logging settings).

## 20.3 Procedure for Using

### Devices and software to be used

The devices and software to be used for the data logging function are shown below.

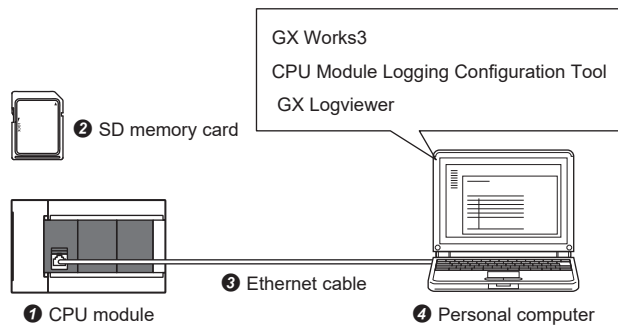

No.	Name	Description
①	CPU module*1	FX5 CPU module
②	SD memory card	NZ1MEM-nGBSD (n means the number of bytes.)
③	Ethernet cable	Standard Ethernet cable
④	Personal computer	Personal computer in which the following software*2 is installed <ul style="list-style-type: none"> <li>• GX Works3</li> <li>• CPU Module Logging Configuration Tool</li> <li>• GX LogViewer</li> </ul>

\*1 Use the CPU module with the latest firmware version. (☞ Page 89 FIRMWARE UPDATE FUNCTION)

\*2 Use the latest version of software.

### Usage flow

The following shows the flow of using the data logging function. The detailed procedure is explained based on setting examples.

1. Set parameters using GX Works3. (☞ Page 153 Setting parameters)
2. Set data logging using the CPU Module Logging Configuration Tool. (☞ Page 154 Setting data logging)
3. Write the data logging settings to the CPU module. (☞ Page 157 Writing the data logging setting)
4. Start data logging execution. (☞ Page 158 Executing data logging)
5. Stop data logging execution. (☞ Page 159 Stopping data logging)
6. Save a data logging file in any location on the personal computer. (☞ Page 159 Saving data logging files)
7. Check the data logging file. For checking, the following three methods are available.
  - ☞ Page 160 Setting example 1: Checking logging data with a CSV file\*1
  - ☞ Page 160 Example 2: Checking logging data on the program editor\*2
  - ☞ Page 161 Example 2: Checking logging data in a waveform graph

\*1 Only when the data logging file storage format is set to a CSV file

\*2 Only when the data logging file storage format is set to a binary file



# Setting example

The procedures for using continuous logging and trigger logging are described with Setting example 1 and Setting example 2.

## Setting example 1: Continuous logging

The following shows a setting example of collecting device values of D0, D1, and M0 for 10 seconds at 10ms intervals after data logging execution is started by operating the tool.

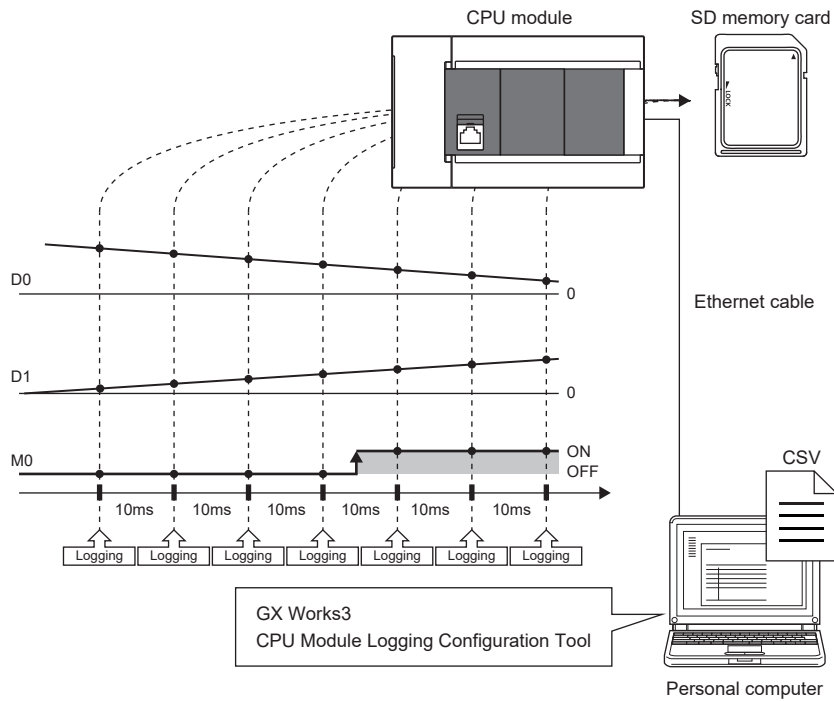

Setting item	Description
Logging type	Continuous logging
File storage format	CSV file
Number of records	1000 records
Collection interval	Time specification: 10 milliseconds
Logging target data	D0, D1, M0

### ■Checking the data logging file

Check the saved data logging file (CSV file) by opening it on your personal computer.

[LOGGING]	FX5CPU_2	3	4	5	2
Logging test					
DATE[TIME[YYYY/MM/DD hh:mm:ss.sss]	INTERVAL	INDEX	SHORT[DEC.0]	SHORT[DEC.0]	BIT[1:0]
TIME	INTERVAL[us]	INDEX	D0	D1	M0
2022/4/1 0:31	10000	4001	16111	32222	1
2022/4/1 0:31	10000	4002	16158	32316	1
2022/4/1 0:31	10000	4003	16204	32408	1
2022/4/1 0:31	10000	4004	16250	32500	1
2022/4/1 0:31	10000	4005	16296	32592	1
2022/4/1 0:31	10000	4006	16343	32686	1
2022/4/1 0:31	10000	4007	16389	-32758	0
2022/4/1 0:31	10000	4008	16435	-32666	0
2022/4/1 0:31	10000	4009	16481	-32574	0
2022/4/1 0:31	10000	4010	16528	-32480	0

## Setting example 2: Trigger logging

The following shows a setting example of collecting device values of D0, D1, and M0 for two seconds immediately before and five seconds immediately after the trigger occurrence (M0 is "↑") at 10ms intervals after data logging execution is started by operating the tool.

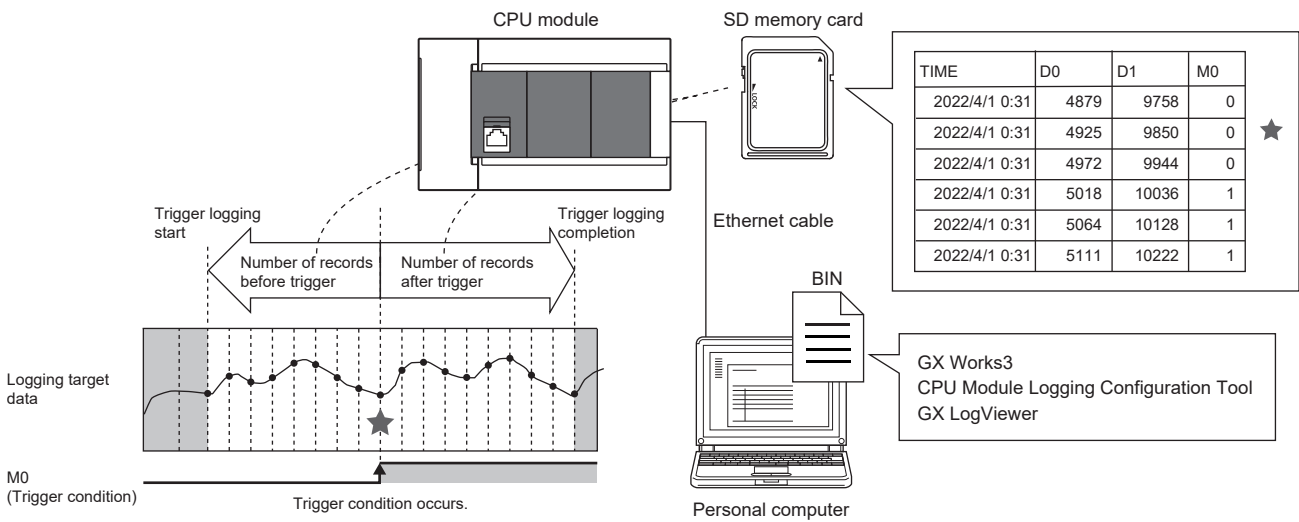

Setting item	Description
Logging type	Trigger logging
File storage format	Binary file
Trigger	M0 is "↑"
Number of records	<ul style="list-style-type: none"> <li>• Before trigger: 200 records</li> <li>• After trigger 500 records</li> </ul>
Collection interval	Time specification: 10 milliseconds
Logging target data	D0, D1, M0

### ■Checking the data logging file

Check the saved data logging file (bin file) by displaying data on the program editor using the offline monitor.

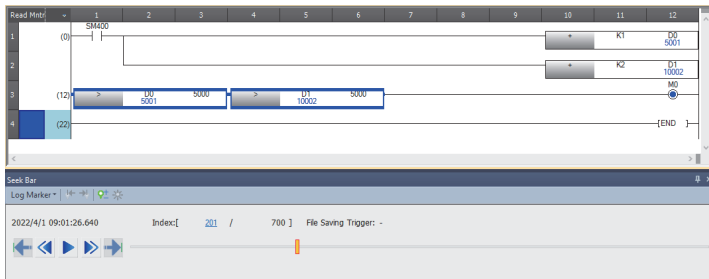

Check the saved data logging file (bin file) by displaying data in a waveform graph using GX LogViewer.

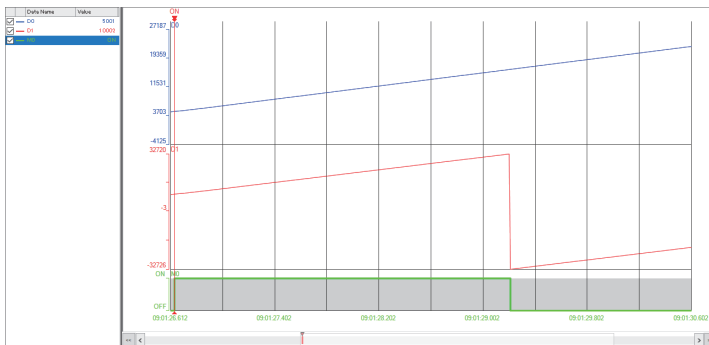

# Programs example

The following shows a program example of executing data logging in Setting example 1 and Setting example 2.

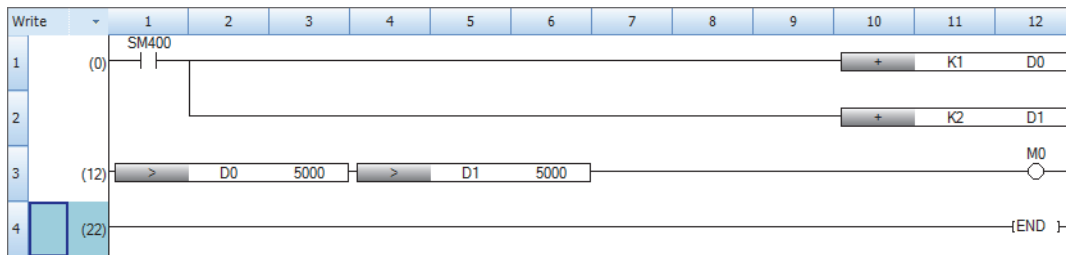

## Operating procedure

This section shows the operating procedure for Setting example 1 and Setting example 2 (the CPU Module Logging Configuration Tool windows show the setting details of Setting example 2).

### Setting parameters

1. Start GX Works3 and create a new project.

[Project] ⇒ [New]

2. Select the details shown below and click [OK].

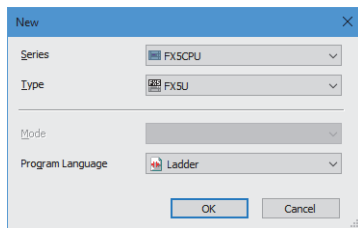

3. Click [OK] with the details shown below as-is.

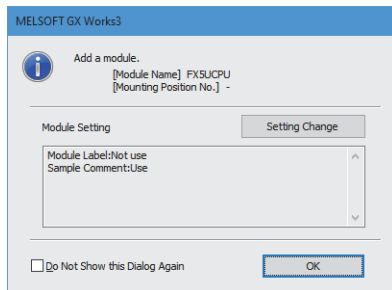

4. Open "Memory/Device Setting" and check that "Function to Use Internal Buffer" is set to "Data Logging Function".

Navigation window ⇒ [Parameter] ⇒ [FX5UCPU] ⇒ [CPU Parameter] ⇒ [Memory/Device Setting]

Setting Item	Item	Setting
	<b>Internal Buffer Capacity Setting</b>	
	Total Capacity	320 K Byte
	Function to Use Internal Buffer	Data Logging Function

## Setting data logging

1. In the menu window of GX Works3, start the CPU Module Logging Configuration Tool.

 [Tool] ⇒ [Logging Configuration Tool]

2. Open the data logging setting window.

 [Data Logging Setting] ⇒ [Edit]

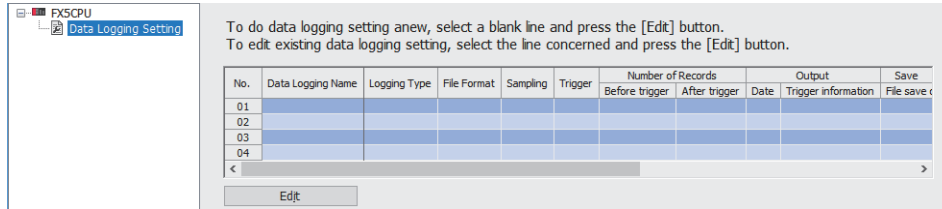

3. Select "Logging type"\*1 and "File format"\*2, and click [Next].

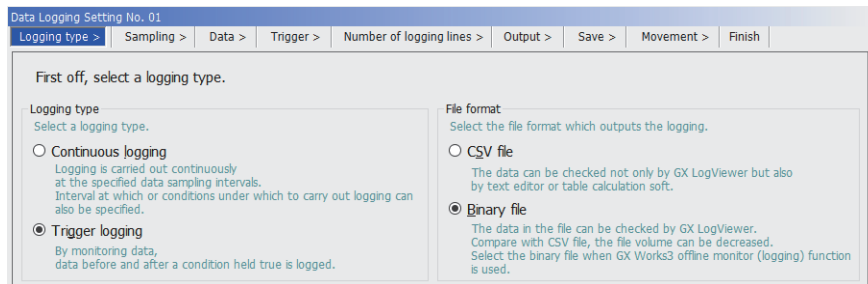

Setting example 1	Setting example 2
<ul style="list-style-type: none"> <li>■ Logging type Select "Continuous logging".</li> <li>■ File format Select "CSV file".</li> </ul>	<ul style="list-style-type: none"> <li>■ Logging type Select "Trigger logging".</li> <li>■ File format Select "Binary file".</li> </ul>

\*1 For details on the setting details, refer to the following table.

 Page 163 Logging type

\*2 For details on the setting details, refer to the following table.

 Page 169 Data logging file

4. Set the collection interval\*1, and click [Next]. Select "Time specification" this time, and enter 10 milliseconds.

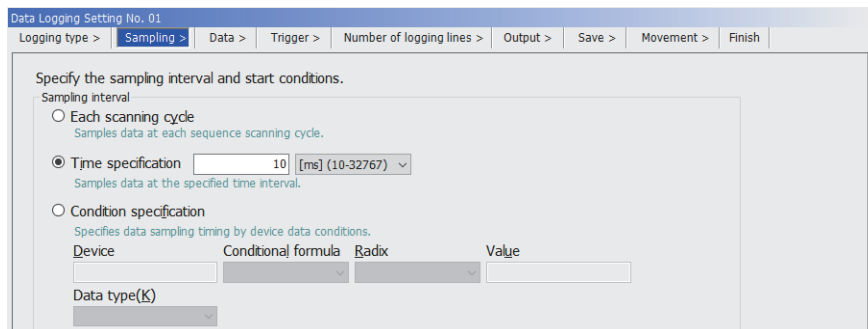

\*1 For details on the setting details, refer to the following table.

 Page 165 Data collection conditions

5. Set the logging target data<sup>\*1</sup>, and click [Next].

No.	Head	Device	Last	Data Type	Size [Byte]	Output Format
001	D0	D0	D0	Word[signed]		Word[signed]
002	D1	D1	D1	Word[signed]		Word[signed]
003	M0	M0	M0	Bit		ON:1, OFF:0
004						

**Setting example 1**

Enter D0, D1, and M0 in the "Head" column.

**Setting example 2**

Enter D0, D1, and M0 in the "Head" column.

\*1 For details on the setting details, refer to the following table.

☞ Page 167 Target data

6. Set the trigger<sup>\*1</sup>, and click [Next]. This setting is performed only when trigger logging is selected for the logging type.

**Setting example 1**

No setting item Proceed to step 8.

**Setting example 2**

- Select "Condition specification".
- Enter M0 for "Device".
- Select "↑" for "Conditional formula".

\*1 For details on the setting details, refer to the following table.

☞ Page 168 Trigger condition

7. Specify a value for "Number of records (before trigger)/Number of records (after trigger)"<sup>\*1</sup>, and click [Next]. This setting is performed only when trigger logging is selected for the logging type.

**Setting example 1**

No setting item Proceed to step 8.

**Setting example 2**

- Enter 200 for "Number of records (before trigger)".
- Enter 500 for "Number of records (after trigger)".

\*1 For details on the setting details, refer to the following table.

☞ Page 165 Number of records

**8.** Set the items to be output into the file\*<sup>1</sup>, and click [Next].

Setting example 1	Setting example 2
<ul style="list-style-type: none"> <li>• Select the checkbox for "Output data".</li> <li>• Select the checkbox for "Output index".</li> <li>• Select the checkbox for "Output data sampling interval".</li> <li>• Select the checkbox for "Output comments".</li> <li>• Enter Logging Test_Continuation for "Comment".</li> </ul>	<ul style="list-style-type: none"> <li>• Select the checkbox for "Output data".</li> <li>• Select the checkbox for "Output trigger information".</li> <li>• Select the checkbox for "Output index".</li> <li>• Select the checkbox for "Output data sampling interval".</li> <li>• Select the checkbox for "Output comments".</li> <li>• Enter Logging Test_Trigger for "Comment".</li> </ul>

\*1 For details on the setting details, refer to the following table.

☞ Page 169 Data output specifications

**9.** Set the logging file save destination and file switching\*<sup>1</sup>, and click [Next].

Setting example 1	Setting example 2
<ul style="list-style-type: none"> <li>• Enter LOG01 for "File save destination".</li> <li>• Select "Simple setting" for "File name".</li> <li>• Enter 3 for "Number of files to be saved".</li> <li>• Select "Overwrite" for "Operation when exceeds the number of files".</li> <li>• Select "Number of records" and enter 1000.</li> </ul>	<ul style="list-style-type: none"> <li>• Enter LOG01 for "File save destination".</li> <li>• Select "Simple setting" for "File name".</li> <li>• Enter 3 for "Number of files to be saved".</li> </ul>

\*1 For details on the setting details, refer to the following table.

☞ Page 175 Saving and file switching

10. Specify the logging operation when the mode transfers to RUN mode\*1. Select "Auto Start" this time, and click [Next].

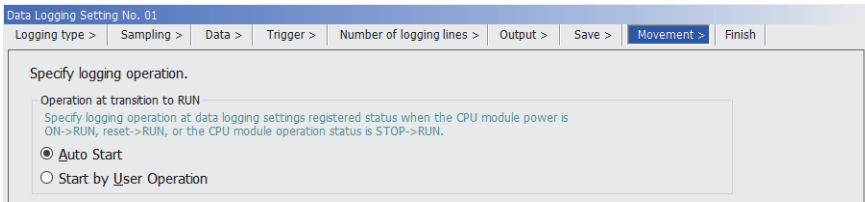

\*1 For details on the setting details, refer to the following table.

☞ Page 188 Setting the operation at the time of transition to RUN

11. Check the set details, give any name\*1, and click [Finish].

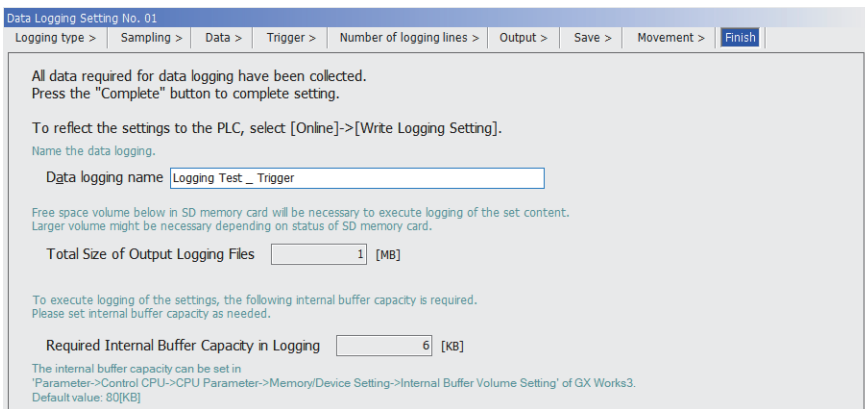

\*1 For details on the setting details, refer to the following table.

☞ Page 934 Finish

## Writing the data logging setting

1. Insert an SD memory card into the CPU module, and turn on the power.
2. Write the data logging settings to the data memory or SD memory card.

☞ [Online] ⇔ [Write Logging Setting]

3. Click [Write].

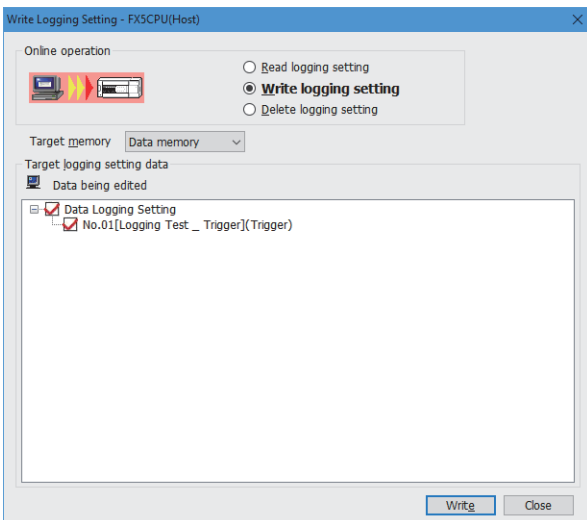

## Executing data logging

1. Set the CPU module to the RUN status.
  2. Open the "Logging Status and Operation" window.
-  [Online] ⇄ [Logging Status and Operation]
3. Check the target of data logging execution (multiple targets can be selected). Select "No.01" this time.

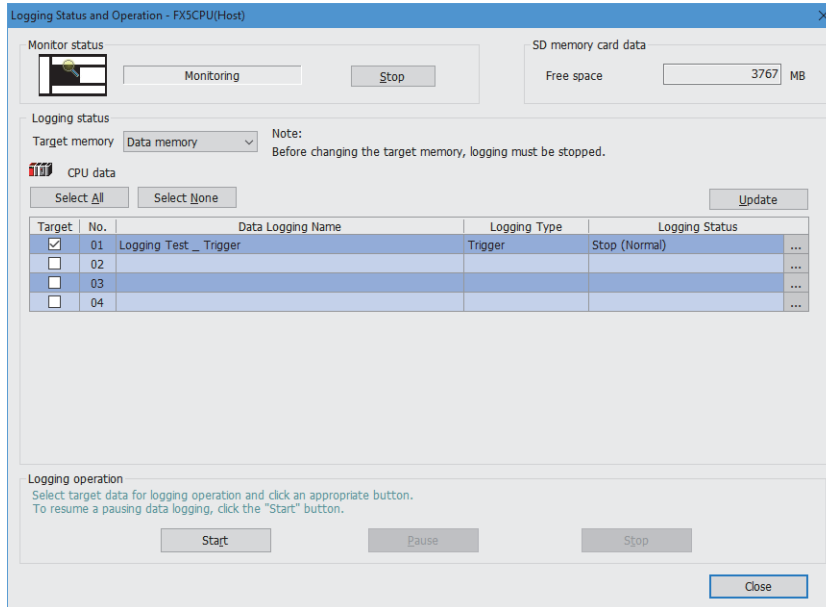

4. Start the data logging by clicking the [Start] button. (When multiple items are selected, they are executed simultaneously.)
5. The logging status changes from "Stop (Normal)" to a state in the following table.

Setting example 1	Setting example 2
"Collecting"	<ul style="list-style-type: none"> <li>• Before trigger occurrence: "Waiting trigger Collecting before trigger"</li> <li>• After trigger occurrence: "Collecting after trigger"</li> <li>• After completion of collection: "Collection Completed"</li> </ul>

For the logging status, refer to the following.

 Page 924 Logging status and operation



## Stopping data logging

1. Open the "Logging Status and Operation" window.

 [Online] ⇨ [Logging Status and Operation]

2. Check the target of data logging stop.

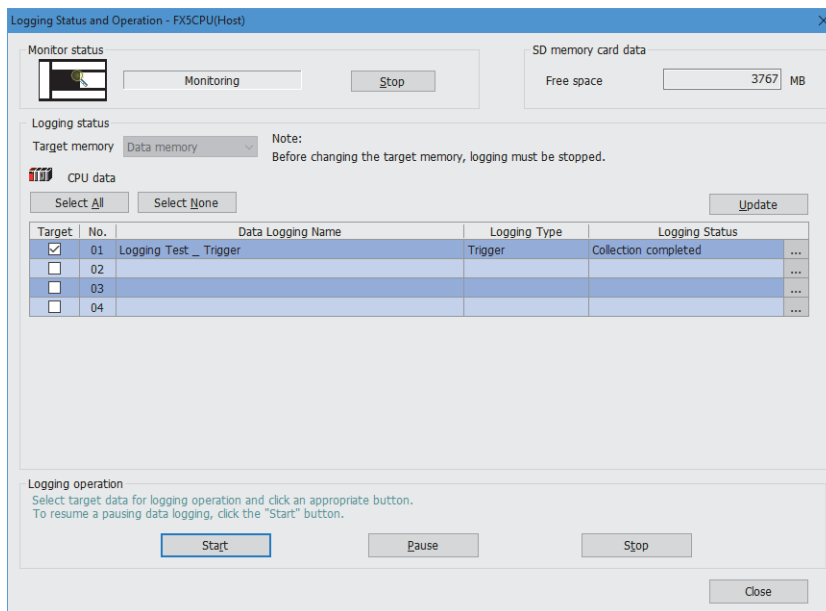

3. Stop data logging execution by clicking the [Stop] button.

4. The logging status changes to "Stop (Normal)".

### Point

Data logging execution (start/stop/suspend) can also be executed by using a special relay.

 [Page 162 Data Logging Execution by Special Relay](#)

## Saving data logging files

1. Open the "Logging File Operation" window.

 [Online] ⇨ [Logging File Operation]

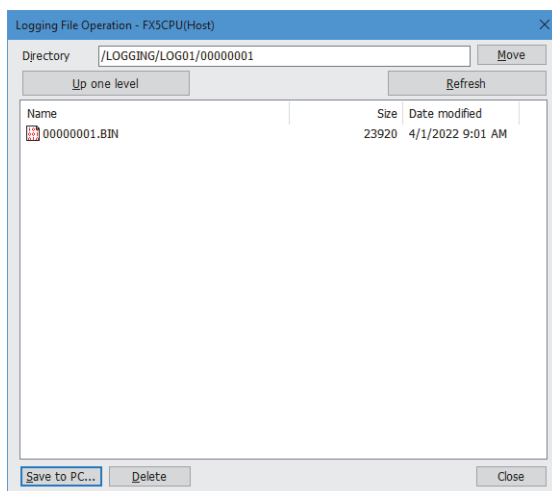

2. Specify the directory and select the target file.

3. Click the [Save to PC] button.

4. Specify the save destination and click the [Save] button.

5. The data logging file is saved into the specified location.

## Setting example 1: Checking logging data with a CSV file

1. Open a data logging file (\*.csv) saved in your personal computer using such an application as Excel.
2. The data logging data can be checked.

[LOGGING]	FX5CPU_2	3	4	5	2
Logging test					
DATE TIME[YYYY/MM/DD hh:mm:ss.sss]	INTERVAL	INDEX	SHORT[DEC.0]	SHORT[DEC.0]	BIT[1;0]
TIME	INTERVAL[us]	INDEX	D0	D1	M0
2022/4/1 0:31	10000	4001	16111	32222	1
2022/4/1 0:31	10000	4002	16158	32316	1
2022/4/1 0:31	10000	4003	16204	32408	1
2022/4/1 0:31	10000	4004	16250	32500	1
2022/4/1 0:31	10000	4005	16296	32592	1
2022/4/1 0:31	10000	4006	16343	32686	1
2022/4/1 0:31	10000	4007	16389	-32758	0
2022/4/1 0:31	10000	4008	16435	-32666	0
2022/4/1 0:31	10000	4009	16481	-32574	0
2022/4/1 0:31	10000	4010	16528	-32480	0

## Example 2: Checking logging data on the program editor

1. Open the GX Works3 program used for data logging.
2. Start the offline monitor. Open a data logging file (\*.bin) saved in your personal computer.  
 [Recording] ⇒ [Start Offline Monitor] ⇒ [Logging File]
3. The data logging data can be checked on the program editor.

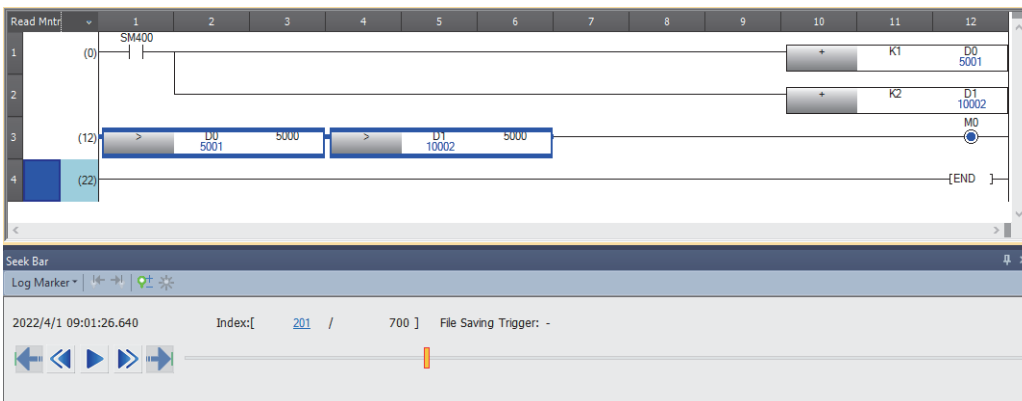

## Example 2: Checking logging data in a waveform graph

1. While using the offline monitor, select all devices on the program editor.
2. Perform the following operation on the program editor.

☞ Right-click the mouse ⇨ [Wave Display (Offline Monitor)].

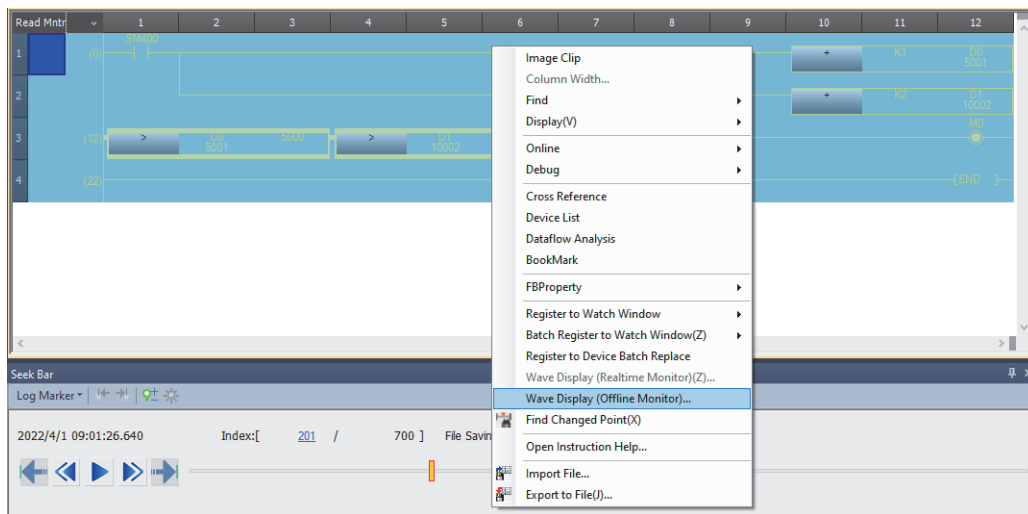

3. GX LogViewer starts, enabling the logging data to be checked in a waveform graph.

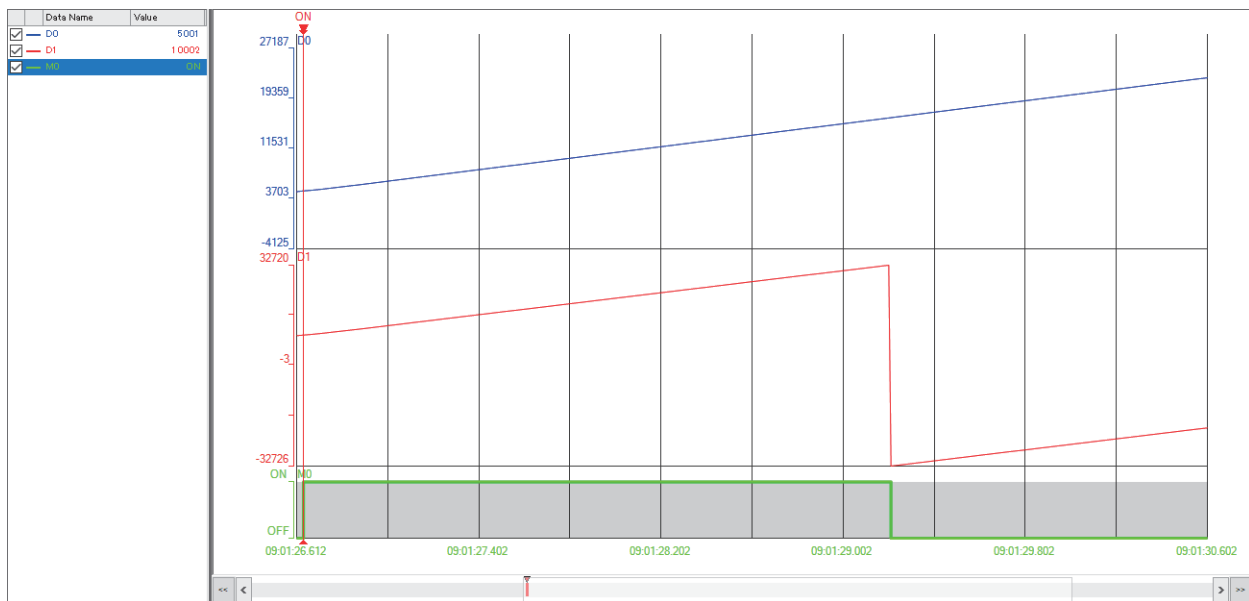

For details on GX LogViewer, refer to the following:

GX LogViewer Version 1 Operating Manual

## 20.4 Data Logging Execution by Special Relay

The data logging setting can be registered by the special relay and be executed on the data logging setting file stored in the SD memory card. (Data logging operations such as start and stop can be performed without using the CPU Module Logging Configuration Tool.)

This operation can be used together with each operation of the CPU Module Logging Configuration Tool.

### Operating procedure

The following describes the procedure for executing data logging in Setting No.1 by using a special relay (SM).

1. Write the effective setting data to the SD memory card with CPU module logging setting tool.

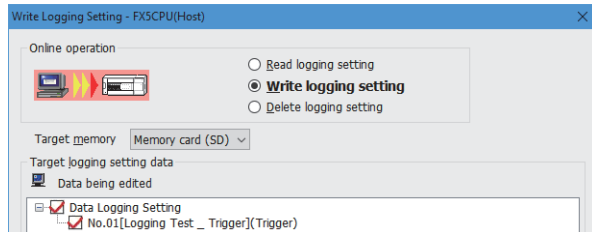

2. When SM9300 (Data logging register/clear flag) is turned ON, the setting data in the SD memory card will be registered.
3. When SM1312 (Data logging suspend/resume flag) is turned OFF, the execution of data logging will start. (Data logging can be executed for multiple setting numbers simultaneously.)
4. To suspend the data logging, turn ON SM1312 (Data logging suspend/resume flag). To stop the data logging, turn OFF SM9300 (Data logging register/clear flag).

### Point

- The data logging cannot be started even when writing the setting and turning power off and on or resetting. To start the data logging, make sure to turn ON the special relay (Data logging register/clear flag), and turn OFF the special relay (Data logging suspend/resume).
- With regards to the trigger logging, the data logging setting registration attempt fails if the trigger condition is satisfied.
- It takes a certain amount of time to stop or suspend the data logging after either of these commands is issued by special relay (because the data logging is not stopped or suspended unless the data stored in the internal buffer data has been transferred into the SD memory card in response to these commands).
- There may be a case where a time-out error occurs and the data logging is suspended after special relay starts the logging.

### Precautions

The data logging cannot be executed by the special relay for the data logging setting file stored in the data memory.

### Data logging resume

When an error occurs during the data logging execution, the following operation is required to resume the data logging from the program, etc.

### Operating procedure

1. Clear the cause of error, turn OFF the special relay (Data logging register/clear), and set the data logging status to the disable status.
2. After confirming the special relay (Data logging preparation) is OFF, turn ON the special relay (Data logging register/clear flag).
3. After confirming the special relay (Data logging preparation) is ON, turn OFF the special relay (Data logging suspend/resume).

## Special relay and special register used by the data logging function

For details on the special relays and special registers used by the data logging function, refer to the following:

- Special relay: Special relay related to the data logging function (☞ Page 777 Data logging function)
- Special register: Special register related with the data logging function (☞ Page 808 Data logging function)

# 20.5 Details of Specifications

## Logging type

The following table describes available methods of data collection.

Logging type	Data collection method	Application
Continuous logging	Continuously collects specified data at specified interval or timing.	Allows the user to continuously record specified data for a certain period of time and check such data in any timing.
Trigger logging	Collects specified data at specified interval or timing and extracts a specified number of data records before and after the satisfaction of a trigger condition.	Allows the user to monitor the content of specified data before and after the satisfaction of a trigger condition. For example, by setting the device for error occurrence as a trigger, logging data before and after error occurrence can be checked.

20

### Continuous logging

In continuous logging, the CPU module stores specified data in its internal buffer at a specified collection interval or timing and, at the time of a file save operation, it saves the data in a data logging file residing in the storage memory. The timing of a file save operation and the number of saved files can be specified using "File switching timing" and "Number of files to be saved" in the CPU Module Logging Configuration Tool.

To save a data logging file by specifying "File switching timing", even if a data logging file after file switching is not saved, the previously saved data logging file can be read.

If the "Stop" has been set for "Operation when exceeds the number of files" on the setting screen of the CPU Module Logging Configuration Tool, the collection will be finished when the number of saved files reaches the set "number of files to be saved".

#### ■To start continuous logging

Start data logging by start operation from the CPU Module Logging Configuration Tool or the special relay<sup>\*1</sup>.

#### ■To stop continuous logging

The user can clear the data logging setting registration stored in the CPU module and completely stop the data logging by stopping the data logging from CPU Module Logging Configuration Tool or special relay<sup>\*1</sup>. (The special relay (data logging start) turns off.)

\*1 This setting is valid only when the data logging setting file is written in the SD memory card. (☞ Page 162 Data Logging Execution by Special Relay)

#### ■To suspend/resume continuous logging

The user can suspend data logging with the data logging settings remaining intact by doing either of the following:

- Instruct the CPU Module Logging Configuration Tool or special relay<sup>\*1</sup> to suspend data logging (the special relay (data logging start) turns off).
- Turn off to on the special relay (Data logging suspend/resume flag).

To resume continuous logging from suspension, do either of the following:

- Instruct the CPU Module Logging Configuration Tool or special relay<sup>\*1</sup> to resume data logging (the special relay (data logging start) turns on).
- Turn on to off the special relay (Data logging suspend/resume flag).

\*1 This setting is valid only when the data logging setting file is written in the SD memory card. (☞ Page 162 Data Logging Execution by Special Relay)

## Trigger logging

In trigger logging, the CPU module stores specified data in its internal buffer at a specified collection interval or timing; it extracts a specified number of data records before and after the satisfaction of a trigger condition and saves the extracted data in a data logging file residing in the storage memory. Note that data collection is performed not only at the specified collection interval or timing but also when a trigger condition is met. In addition, once a trigger condition is met, any subsequent trigger conditions are ignored.

When the data for the number of records specified by the CPU Module Logging Configuration Tool is collected and written to the storage memory, the collection will be finished.

### ■To start trigger logging

Start data logging by start operation from the CPU Module Logging Configuration Tool or the special relay<sup>\*1</sup>.

### ■To stop trigger logging

The user can clear the data logging setting registration stored in the CPU module and completely stop the data logging by stopping the data logging from CPU Module Logging Configuration Tool or special relay<sup>\*1</sup>. (The special relay (data logging start) turns off.)

\*1 This setting is valid only when the data logging setting file is written in the SD memory card. (☞ Page 162 Data Logging Execution by Special Relay)

### ■To suspend/resume trigger logging

The user can suspend data logging with the data logging settings remaining intact by doing either of the following:

- Instruct the CPU Module Logging Configuration Tool or special relay<sup>\*1</sup> to suspend data logging (the special relay (data logging start) turns off).
- Turn off to on the special relay (Data logging suspend/resume flag).

To resume trigger logging from suspension, do either of the following:

- Instruct the CPU Module Logging Configuration Tool or special relay<sup>\*1</sup> to resume data logging (the special relay (data logging start) turns on).
- Turn on to off the special relay (Data logging suspend/resume flag).

\*1 This setting is valid only when the data logging setting file is written in the SD memory card. (☞ Page 162 Data Logging Execution by Special Relay)

## Precautions

If data logging is stopped or data collection is suspended before completion of trigger logging and then data logging is resumed, data collection will be started not from the last logging, but from the initial state before the trigger logging.

### Number of records

Specify the number of records to be collected before and after the satisfaction of a trigger condition. (Page 930 Number of records)

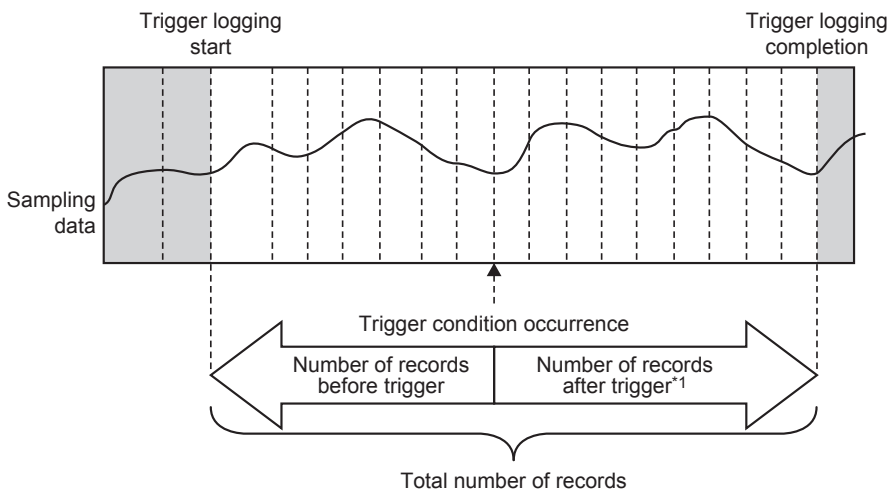

\*1 This number includes the record exactly at the time when the trigger is met.

**Point**

After starting data logging, if the trigger condition is met before data collection of the specified number of records (before trigger) is completed, the number of sampled records will be less than that specified.

## Data collection conditions

This section describes the timing when data is collected and the conditions under which data is collected.

Data collection conditions	Description
Each scanning cycle	Collects data during the END processing of each scan.
Time specification	Collects data during the END processing after specified time interval.
Condition specification	Collects data when the monitored data meets the specified condition during the END processing.

### Each scanning cycle

Collects data during the END processing of each scan.

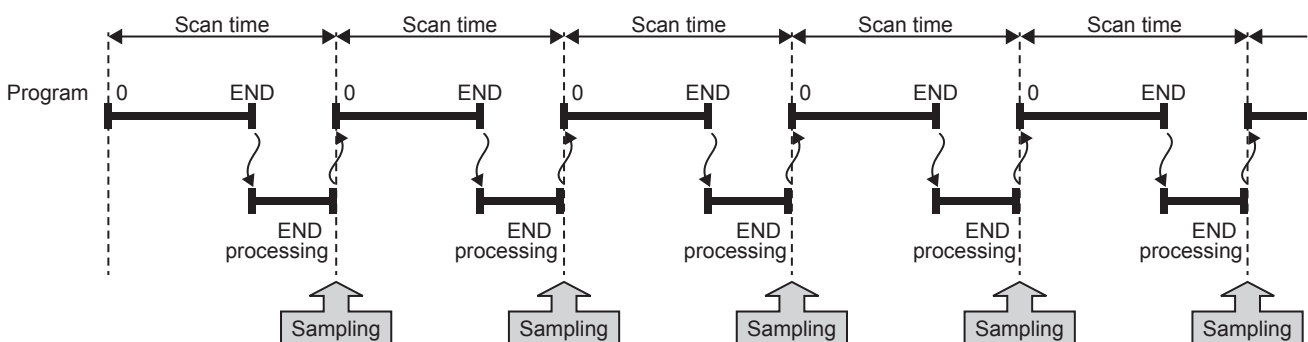

### Precautions

When specifying each scanning cycle, make only one data logging setting.

## Time specification

Allows the user to specify the collection time interval.

The CPU module starts collecting data at the time of the following END process after the specified time has elapsed. Ensure that the "Scan time" is less than "Time specification". If the scan time is longer than the specified time and the collection interval or the collection timing occurs more than once during the same scan, data is collected only once during the END processing. Data collection is performed on a scan by scan basis, which is the same operation as when "Each scanning cycle" is used.

**Ex.**

When the time interval is set to 10 milliseconds

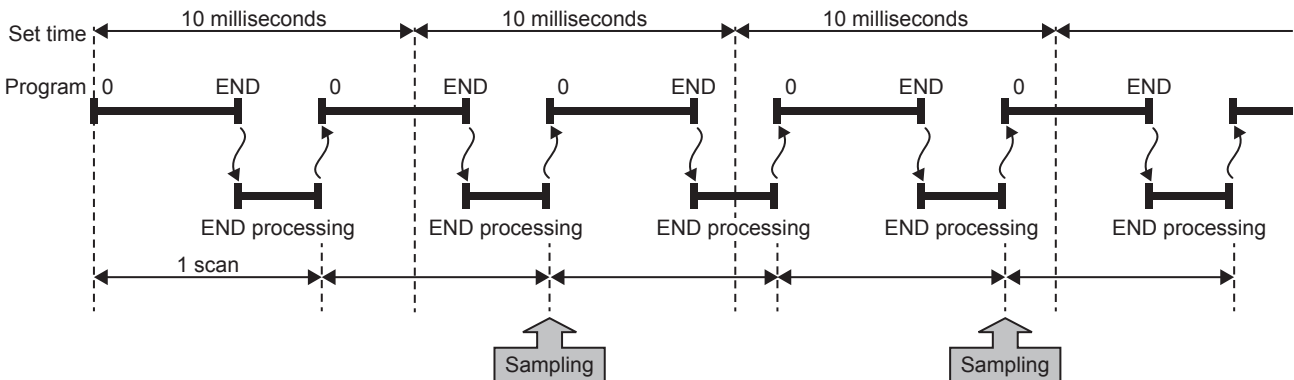

## Condition specification

This option allows the user to set the data collection timing by specifying the device data conditions.

Collects data when the monitored data meets the specified condition during the END processing.

### ■ To collect data continuously while the conditions are met

The following conditional formula causes the data logging function to collect data continuously while the conditions are met:

- =: When the current value of the monitored data is equal to the comparison value
- ≠: When the current value of the monitored data is not equal to the comparison value
- ≥: When the current value of the monitored data is equal to or larger than the comparison value
- >: When the current value of the monitored data is larger than the comparison value
- ≤: When the current value of the monitored data is equal to or smaller than the comparison value
- <: When the current value of the monitored data is smaller than the comparison value

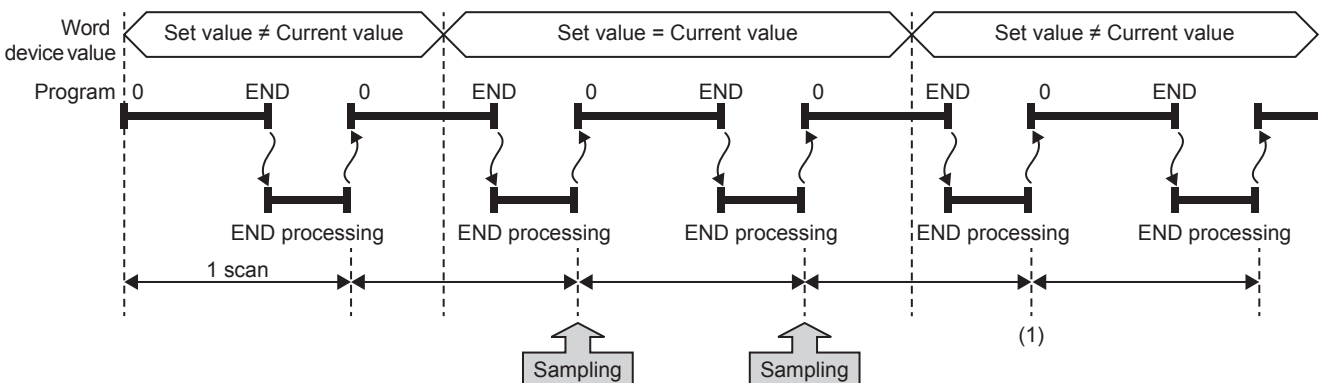

(1) During the END processing, the data logging function does not collect data because the conditions are not met.



## ■ To collect data only when the state changes

The following conditional formula causes the data logging function to collect data only during the END processing for the scans where the conditional formula is met. It does not collect data for any single scan where the conditional formula is not met during the END processing (even if the conditional formula is met before the END processing is initiated).

- ↑: When the specified data turns off and on
- ↓: When the specified data turns on and off
- At change: When the current value of the specified data changes

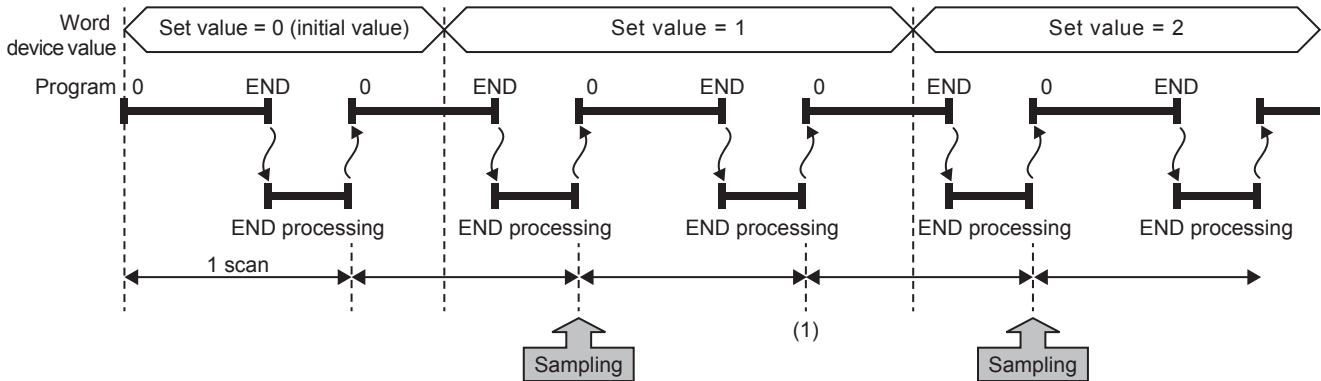

(1) The data logging function does not collect data because there has been no change in state since the last scan.

## ■ Specifying the monitored data

For monitored data, the following devices can be specified. The data types that can be selected include bit/word (unsigned), word (signed), double word (unsigned), and double word (signed).

Type	Device <sup>*1</sup>
Bit device <sup>*2</sup>	X, Y, M, SM, L, B, F, SB, T (contact) <sup>*4</sup> , ST (contact) <sup>*4</sup> , C (contact) <sup>*4</sup> , LC (contact) <sup>*4</sup> , BL□\S□ <sup>*5</sup>
Word device <sup>*3</sup>	T (Current value) <sup>*6</sup> , ST (Current value) <sup>*6</sup> , C (Current value) <sup>*6</sup> , D, SD, W, SW, R, U□\G□ <sup>*7</sup>
Double-word device	LC (current value) <sup>*6</sup>

\*1 Index modification, and indirect specification cannot be specified.

\*2 For bit devices, bit specification of word cannot be specified.

\*3 For word devices, nibble specification of bit devices cannot be specified.

\*4 To specify these devices with the CPU Module Logging Configuration Tool, use T (contact): TS, ST (contact): STS, C (contact): CS, LC (contact): LCS.

\*5 Applicable only to FX5U/FX5UC CPU module.

\*6 To specify these devices with the CPU Module Logging Configuration Tool, use T (current value): T or TN, ST (current value): ST or STN, C (current value): C or CN, and LC (current value): LC or LCN.

\*7 This format is supported by the FX5UJ and FX5U/FX5UC CPU modules.

## Target data

This section describes the data to be collected by data logging.

### Number of data points

The data logging function can collect up to 512 data records. (4 settings × 128 records)<sup>\*1</sup>

\*1 Duplicate data records are counted as unique records.

## Data to be collected

The data for the following devices can be specified to be collected.

Type	Device <sup>*1</sup>
Bit device <sup>*2</sup>	X, Y, M, SM, L, B, F, SB, T (contact) <sup>*4</sup> , T (coil) <sup>*4</sup> , ST (contact) <sup>*4</sup> , ST (coil) <sup>*4</sup> , C (contact) <sup>*4</sup> , C (coil) <sup>*4</sup> , LC (contact) <sup>*4</sup> , LC (coil) <sup>*4</sup> , BL□\S□ <sup>*5</sup>
Word device <sup>*3</sup>	T (Current value) <sup>*6</sup> , ST (Current value) <sup>*6</sup> , C (Current value) <sup>*6</sup> , D, SD, W, SW, R, U□\G□ <sup>*7</sup>
Double-word device	LC (current value) <sup>*6</sup>

\*1 Index modification, and indirect specification cannot be specified.

\*2 For bit devices, bit specification of word cannot be specified.

\*3 For word devices, nibble specification of bit devices cannot be specified.

\*4 To specify these devices with the CPU Module Logging Configuration Tool, use T (contact): TS, T (coil): TC, ST (contact): STS, ST (coil): STC, C (contact): CS, C (coil): CC, LC (contact): LCS, and LC (coil): LCC.

\*5 Applicable only to FX5U/FX5UC CPU module.

\*6 To specify these devices with the CPU Module Logging Configuration Tool, use T (current value): T or TN, ST (current value): ST or STN, C (current value): C or CN, and LC (current value): LC or LCN.

\*7 This format is supported by the FX5UJ and FX5U/FX5UC CPU modules.

## Data type

The following table shows the number of data records for each data type.

Data type	Number of data points
Bit	1
Word (signed)	1
Double word (signed)	2
Word (unsigned)	1
Double word (unsigned)	2
Single-precision real number	2
Time	2
String <sup>*1,2</sup>	Specified size/2 <sup>*3</sup>
Numeric string <sup>*2</sup>	Specified size/2 <sup>*3</sup>

\*1 Outputs the entered character code.

\*2 Collected as binary data.

\*3 The specified size can be 1 to 256. If the specified size is an odd number, the number of data records is rounded to the next higher integer. Example: The number of data records is 3 if the specified size is 5.

## Trigger condition

The following table lists the conditions to be used as a trigger.

Trigger condition	Description
Condition specification	A trigger occurs when the monitored data meets the specified condition.
When trigger instruction executed	A trigger occurs when the LOGTRG instruction is executed.

## Precautions

- When registering the data logging settings, ensure that the trigger conditions are not met. If the trigger conditions are met, the data logging settings cannot be registered.
- After the trigger condition is established in the trigger logging operation, if the trigger condition is met again, the CPU module does not recognize a new trigger condition.

## Condition specification

Configure the trigger condition based on the device data value. A trigger occurs when the monitored data meets the specified condition.

- ↑: When the specified data turns off and on
- ↓: When the specified data turns on and off
- =: When the monitored data is equal to the comparison value, regardless of whether or not its current value is equal
- ≠: When the monitored data is not equal to the comparison value, regardless of whether or not its current value is equal
- ≥: When the monitored data is greater than or equal to the comparison value, regardless of whether or not its current value is equal
- >: When the monitored data is greater than the comparison value, regardless of whether or not its current value is equal
- ≤: When the monitored data is less than or equal to the comparison value, regardless of whether or not its current value is equal
- <: When the monitored data is less than the comparison value, regardless of whether or not its current value is equal
- At change: When the current value of the specified data changes

### ■ Specifying the monitored data

For the device change specification, monitored data can be configured to be collected from the devices listed in the following table. The data types that can be selected include bit/word (unsigned), word (signed), double word (unsigned), and double word (signed). If double word (unsigned) or double word (signed) is specified, a trigger occurs only when data equal to one double word is written. No trigger occurs when only the upper or lower word of a double word is written.

Type	Device *1
Bit device *2	X, Y, M, SM, L, B, F, SB, T (contact) *4, ST (contact) *4, C (contact) *4, LC (contact) *4, BL□\S□ *6
Word device *3	T (Current value) *5, ST (Current value) *5, C (Current value) *5, D, SD, W, SW, R, U□\G□ *7
Double-word device	LC (Current value) *5

\*1 Index modification, and indirect specification cannot be specified.

\*2 For bit devices, bit specification of word cannot be specified.

\*3 For word devices, nibble specification of bit devices cannot be specified.

\*4 To specify these devices with the CPU Module Logging Configuration Tool, use T (contact): TS, ST (contact): STS, C (contact): CS, LC (contact): LCS.

\*5 To specify these devices with the CPU Module Logging Configuration Tool, use T (current value): T or TN, ST (current value): ST or STN, C (current value): C or CN, and LC (current value): LC or LCN.

\*6 Only FX5U/FX5UC CPU module is supported.

\*7 This format is supported by the FX5UJ and FX5U/FX5UC CPU modules.

## When trigger instruction executed

A trigger occurs when the LOGTRG instruction is executed. (MELSEC iQ-F FX5 Programming Manual (Instructions, Standard Functions/Function Blocks))

## Data logging file

This section describes data logging files.

The following storage formats are available for data logging files.

File format	Application
CSV file format	This is a file format which can be open in generic-purpose application programs such as Excel and Notepad. GX LogViewer is also available for displaying data.
Binary file format	Comparing the CSV file format, the size of files is small and therefore quicker access to files is provided. GX LogViewer is also available for displaying data.

## Data output specifications

The output specifications for each file format are shown below.

## ■CSV file format

The specifications for the CSV file format and the details of the output data are shown below.

- Format specifications

Item	Description
Delimiter	Commas (,)
Return code	CRLF (0x0D, 0x0A)
Character code	ASCII code or Shift-JIS code
Field data	Not enclosed by double quotation marks (" ") Double quotation marks (" ") and commas (,) cannot be used in each data.

- File format example

Output items can be specified (  Page 931 Output)

File information row	[LOGGING]	FX5CPU_2	3	4	5	2	
Comment row	LOG01						
Data type information row	DATETIME[YYYY/MM/DD hh:mm:ss.sss]	INTERVAL	INDEX	SHORT[DEC.0]	BIT[1.0]	BIT[1:]	TRIGGER[*]
Data name row	TIME(UTC+09:00)	INTERVAL[μs]	INDEX	D1	M0	M1	Trigger
Data rows	2020/04/01 12:00:00,000	100	1	1234	1	1	
	2020/04/01 12:01:00,000	100	2	1234	0	0	
	2020/04/01 12:02:00,000	100	3	1234	0	0	
	2020/04/01 12:03:00,000	100	4	0	0	0	
	2020/04/01 12:04:00,000	100	5	0	0	0	
	2020/04/01 12:05:00,000	100	6	0	0	0	*
	2020/04/01 12:06:00,000	100					
	2020/04/01 12:07:00,000	100					

Annotations in the diagram:  
 - File type: points to [LOGGING]  
 - Model information\_file version: points to FX5CPU\_2  
 - No. for data type information row: points to 3  
 - No. for data name row: points to 4  
 - No. for data start row: points to 5  
 - No. for comment row: points to 2  
 - Date column: points to DATETIME  
 - Data collection interval column: points to INTERVAL  
 - Index column: points to INDEX  
 - Data columns: points to SHORT, BIT, BIT, TRIGGER  
 - Trigger occurrence information column: points to TRIGGER

- Output content for each data

<File information row>

File-related information is displayed.

Item	Description	Size
File type	[LOGGING] is output.	9 bytes
Model information_file version	"FX5CPU_2" is displayed in the file version which describes the model information.	8 bytes
No. for data type information row	Numerical value indicating the position of the data type information row from the top of the file is placed.	1 byte
No. for data name row	Numerical value indicating the position of the data name row from the top of the file is placed.	1 byte
No. for data start row	Numerical value indicating the starting position of the data row from the top of the file is placed.	1 byte
No. for comment row	Numerical value indicating the position of the comment row from the top of the file is placed. When the comment row is not output, this field is blank.	0 to 1 bytes

**Ex.**

The total size of the file information row can be obtained by the following equation: (when comment is output)

$$9 \text{ (file type)} + 8 \text{ (model information\_file version)} + 1 \text{ (data type information row number)} + 1 \text{ (data name row number)} + 1 \text{ (data start row number)} + 1 \text{ (comment row number)} + 5 \text{ (the number of commas)} + 2 \text{ (CR + LF)} = 28 \text{ bytes}$$

<Comment row>

Comments are displayed.

Item	Description	Size
Comment	Comment specified in CPU Module Logging Configuration Tool is output (Up to 256 double-byte characters can be used.*1 When no comment is set, a blank row is output).	0 to 512 bytes

\*1 Double quotation marks (" "), commas (,), and semicolons (;) cannot be used.

**Ex.**

The total size of the comment row can be obtained by the following equation:

Character size of the specified comment (depending on the specified character string. (A single-byte character is calculated as one byte and a double-byte character is calculated as two bytes.) + 2 (CR + LF)

<Data type information row>

The data type for each column is displayed. This information is output in the following format: (Data type)[(Additional information)].

Item	"Data type" output content	Size	"Additional information" output content	Size
Date column	DATETIME	8 bytes	Format is output. [YYYY/MM/DD hh:mm:ss.sss]	4 to 29 bytes
Data collection interval column	INTERVAL	8 bytes	No additional information	0 byte
Index column	INDEX	5 bytes	No additional information	0 byte
Data column	Bit type: BIT	3 bytes	Bit type: [1;0]	5 bytes
	16-bit integer (signed): SHORT	5 bytes	For decimal format: [DEC.0]	7 bytes
	16-bit integer (unsigned): USHORT	6 bytes	For hexadecimal format: [HEX]	5 bytes
	32-bit integer (signed): LONG	4 bytes	When the decimal fraction format is specified: [DEC. (number of digits of decimal part)]	7 to 8 bytes
	32-bit integer (unsigned): ULONG	5 bytes		
	Single-precision floating point (32-bit): FLOAT	5 bytes	When the exponential format is specified: [EXP. (number of digits of decimal part)]	7 to 8 bytes
	Character string type: STRING	6 bytes	Character string type, numeric string type: the specified data length value (unit: bytes) is output.	3 to 5 bytes
Numeric string type: RAW	3 bytes			
	Time: TIME	4 bytes	No additional information	0 byte
Trigger occurrence information column	TRIGGER	7 bytes	[(string occurred)] is output (semicolons (;), double quotation marks (" "), and commas (,) cannot be used).	3 to 514 bytes

**Ex.**

The size of the data type information row is determined by the following equation when data logging of 128 points of data (signed 16-bit integer, decimal format) is performed (The following sections in the "Output" window are set to be output: "Date" (the output format is YYYY/MM/DD hh:mm:ss.sss), "Data sampling interval", and "Index").

$$(8 + 25) \text{ (date column)} + 8 \text{ (data collection interval column)} + 5 \text{ (index column)} + (5 + 7) \times 128 \text{ (data column)} + 132 \text{ (the number of commas)} + 2 \text{ (CR + LF)}$$

$$= 1716 \text{ bytes}$$

<Data name row>

The data name for each column is displayed.

Item	Description	Size
Date column	TIME (time zone) is output.	4 bytes
Data collection interval column	INTERVAL[us] is output.	12 bytes
Index column	INDEX is output.	5 bytes
Data column	The specified device name is output.	1 to 32 bytes
Trigger occurrence information column	Trigger is output.	7 bytes

**Ex.**

The size of the data name row is determined by the following equation when data logging of 128 data points from D100 to D227 is performed (The following sections in the "Output" window are set to be output: "Date", "Data sampling interval", and "Index").

$$4 \text{ (date column)} + 12 \text{ (data collection interval column)} + 5 \text{ (index column)} + (4 \times 128) \text{ (data column)} + 132 \text{ (the number of commas)} + 2 \text{ (CR + LF)}$$

$$= 667 \text{ bytes}$$

<Data row>

The collected data value is displayed. A single row means the data collection interval. The data collected by the trigger at a time is displayed in the single row.

Item	Description	Size
Date column	Information is output according to the date information.	1 to 32 bytes
Data collection interval column	The time interval from the previous collection time to the current collection time is output. If the maximum display range is exceeded, the count returns to 1 and starts again to output a new time interval (unit: $\mu$ s, display range: 1 to 100000000000).	1 to 12 bytes
Index column	A value which increments in ascending order from 1 is output. When it exceeds the upper limit, it returns to 1 and increments again (range: 1 to 4294967295).	1 to 10 bytes
Data column	The collected data value is output in a format and size in accordance with each data type.	—
	When bits are specified: bit On = 1 and bit Off = 0 are output.	1 byte
	When signed word type is specified: data value is output according to the specified output type.	<ul style="list-style-type: none"> <li>• Decimal format: 1 to 6 bytes</li> <li>• Decimal fraction format: 1 to 21 bytes<sup>*1</sup></li> <li>• Exponential format: 5 to 21 bytes</li> </ul>
	When unsigned word type is specified: data value is output according to the specified output type.	<ul style="list-style-type: none"> <li>• Decimal format: 1 to 6 bytes</li> <li>• Hexadecimal format: 1 to 4 bytes</li> <li>• Decimal fraction format: 1 to 21 bytes<sup>*1</sup></li> <li>• Exponential format: 5 to 21 bytes</li> </ul>
	When signed double word type is specified: data value is output according to the specified output type.	<ul style="list-style-type: none"> <li>• Decimal format: 1 to 11 bytes</li> <li>• Decimal fraction format: 1 to 26 bytes<sup>*1</sup></li> <li>• Exponential format: 5 to 22 bytes</li> </ul>
	When unsigned double word type is specified: data value is output according to the specified output type.	<ul style="list-style-type: none"> <li>• Decimal format: 1 to 11 bytes</li> <li>• Hexadecimal format: 1 to 8 bytes</li> <li>• Decimal fraction format: 1 to 26 bytes<sup>*1</sup></li> <li>• Exponential format: 5 to 22 bytes</li> </ul>
	When single-precision real number is specified: data value is output according to the specified output type. <sup>*2</sup>	<ul style="list-style-type: none"> <li>• Decimal format: 1 to 11 bytes</li> <li>• Decimal fraction format: 1 to 26 bytes</li> <li>• Exponential format: 5 to 22 bytes</li> </ul>
	When character string is specified: the specified character string is output. <sup>*3</sup>	1 to 256 bytes
	When numeric string is specified: the character string which is represented by the hexadecimal in increments of a byte is output without clearance. [Ex.] When the start device is D0 and the numeric string is four bytes, it will be displayed as: D0:0x8A6B, D1:0x41C2 →"6B8AC241"	2 to 512 bytes
	When time is specified: T#-24d20h31m23s648ms to T#24d20h31m23s647ms is displayed.	13 to 20 bytes
Trigger occurrence information column	The specified character string is output when the trigger occurs. In other cases, no character string is output.	0 to 512 bytes

\*1 When the numerical value to be output becomes out of the range of -2147483648.0 to 4294967295.0, it will be displayed in an equivalent format to "exponential format and the number of decimal part digits is nine".

\*2 When the data value is not the output format specified in the data type, "NaN" will be output in the data row.

\*3 When "0" which means the end of a character string is in the data, the subsequent data will not be output. Characters which is out of the range of ASCII or SJIS such as double quotation mark ("), comma (,), semicolon (;) will be replaced with period (.).

**Ex.**

The size of the data type information row is determined by the following equation when data logging of 128 points of data from D100 to D227 (unsigned word type, decimal format) is performed (The following sections in the "Output" window are set to be output: "Date" (the output format is YYYY/MM/DD hh:mm:ss.sss), "Data sampling interval", and "Index").

$$23 \text{ (date column)} + 12 \text{ (data collection interval column)} + 10 \text{ (index column)} + (6 \times 128) \text{ (data column)} + 132 \text{ (the number of commas)} + 2 \text{ (CR + LF)}$$

$$= 947 \text{ bytes}$$

## ■ Binary file format

The following figure shows the configuration of the binary format and details of each data.

- Configuration figure of binary format

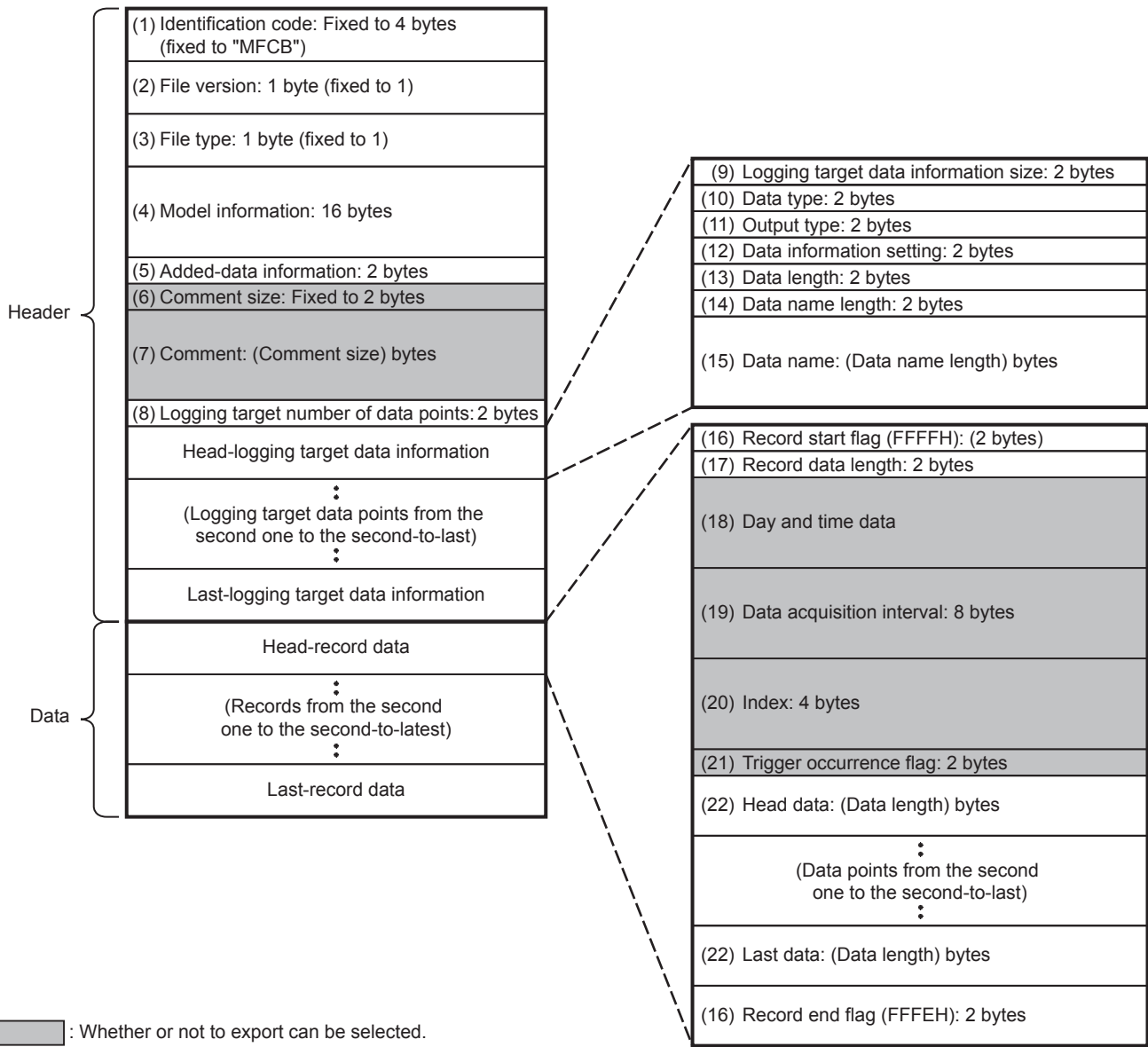

: Whether or not to export can be selected.

• Details of each data

No.	Item	Description	Size (byte)																																																																
(1)	Identification code	MFCB is always output to identify the file.	4																																																																
(2)	File version	File version 1 is displayed.	1																																																																
(3)	File type	The file type is output. (fixed to 1: Continuous/trigger logging)	1																																																																
(4)	Model information	The module model name that outputted binary file is output. The CPU module in use is output in ASCII Code while the remaining area is filled with "0H".	16																																																																
(5)	Added-data information	<p>The output selection setting for the data that can be output is output.</p> <table border="1" style="margin-left: 20px;"> <tr> <td>F</td><td>E</td><td>D</td><td>C</td><td>B</td><td>A</td><td>9</td><td>8</td><td>7</td><td>6</td><td>5</td><td>4</td><td>3</td><td>2</td><td>1</td><td>0</td> </tr> <tr> <td style="background-color: #cccccc;"></td><td style="background-color: #cccccc;"></td><td style="background-color: #cccccc;"></td><td style="background-color: #cccccc;"></td><td style="background-color: #cccccc;"></td><td style="background-color: #cccccc;"></td><td style="background-color: #cccccc;"></td><td style="background-color: #cccccc;"></td><td style="background-color: #cccccc;"></td><td style="background-color: #cccccc;"></td><td style="background-color: #cccccc;"></td><td style="background-color: #cccccc;"></td><td style="background-color: #cccccc;"></td><td style="background-color: #cccccc;"></td><td style="background-color: #cccccc;"></td><td style="background-color: #cccccc;"></td> </tr> <tr> <td></td><td></td><td></td><td></td><td></td><td></td><td></td><td></td><td></td><td></td><td></td><td></td><td></td><td></td><td></td><td></td> </tr> <tr> <td></td><td></td><td></td><td></td><td></td><td></td><td></td><td></td><td></td><td></td><td></td><td></td><td></td><td></td><td></td><td></td> </tr> </table> <p> <b>❶</b> 1: Output date and time data, 0: Do not output date and time data  <b>❷</b> 1: Output a data sampling interval, 0: Do not output a data sampling interval  <b>❸</b> 1: Output a trigger flag, 0: Do not output a trigger flag  <b>❹</b> 1: Output index, 0: Do not output index  <b>❺</b> 1: Output comments, 0: Do not output comments                 </p>	F	E	D	C	B	A	9	8	7	6	5	4	3	2	1	0																																																	2
F	E	D	C	B	A	9	8	7	6	5	4	3	2	1	0																																																				
(6)	Comment size	The comment length of (7) Comment is output.	2																																																																
(7)	Comment	The comment specified in the setting is output in Unicode.	2 to 512																																																																
(8)	Logging target number of logging target data	The number of data points of the data information ((10) to (15)) for data logging is output.	2																																																																
(9)	Logging target data information size	The total size of the data information ((10) to (15)) for data logging is output.	2																																																																

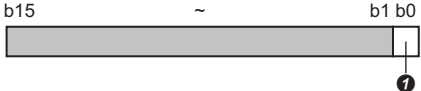
No.	Item	Description	Size (byte)															
(10)	Data type	The numeric value shown below is output depending on the data type. 0000H: Bit 0001H: Word (signed) 0002H: Double word (signed) 0003H: Word (unsigned) 0004H: Double word (unsigned) 0005H: Single-precision real number 0007H: String 0008H: Numeric string 0009H: Time	2															
(11)	Output type	The numeric value shown below is output depending on the set output format. 0001H: Word (signed) 0002H: Double word (signed) 0003H: Word (unsigned) 0004H: Double word (unsigned) 0005H: Single-precision real number FFFFH: Bit, String, Numeric string, Time	2															
(12)	Data information setting	The data-related information is output.	2															
(13)	Data length	The data length of data is output. When the data type is the bit type, it will be output as two bytes.	2															
(14)	Data name length	The length of the data name specified in the setting is output.	2															
(15)	Data name	The data name specified in the setting is output in Unicode.	2 to 512															
(16)	Record start Flag, Record end Flag	The flags for identifying the start and end of the record are output. The FFFFH is output for record start while the FFFEh is output for record end as the fixed flag.	2															
(17)	Record data length	The total size of (18) Day and time data to (22) Last data is output.	2															
(18)	Day and time data	The Day and time data is output. <table border="1" style="margin-left: 20px;"> <tr> <td>b15 to b8</td> <td>b7 to b0</td> <td></td> </tr> <tr> <td>Year</td> <td>Month</td> <td>Year: Last 2 digits of the year, Month: 1 to 12</td> </tr> <tr> <td>Day</td> <td>Time</td> <td>Day: 1 to 31, Time: 0 to 23</td> </tr> <tr> <td>Minute</td> <td>Second</td> <td>Minute: 0 to 59, Second: 0 to 59</td> </tr> <tr> <td colspan="2">Millisecond</td> <td>Millisecond: 0 to 999</td> </tr> </table>	b15 to b8	b7 to b0		Year	Month	Year: Last 2 digits of the year, Month: 1 to 12	Day	Time	Day: 1 to 31, Time: 0 to 23	Minute	Second	Minute: 0 to 59, Second: 0 to 59	Millisecond		Millisecond: 0 to 999	8
b15 to b8	b7 to b0																	
Year	Month	Year: Last 2 digits of the year, Month: 1 to 12																
Day	Time	Day: 1 to 31, Time: 0 to 23																
Minute	Second	Minute: 0 to 59, Second: 0 to 59																
Millisecond		Millisecond: 0 to 999																
(19)	Data acquisition interval	The time interval from the previous collection time to the current collection time is output. (Unit: $\mu$ s, Display range: 1 to 10000000000 (When it exceeds the max value, it returns to "1" and incrementing runs again.)) After logging collection is started, 0 is stored at the first collection.	8															
(20)	Index	The index number ranging from 1 to 4294967295 of data, which was collected by the data logging function, is output. When it exceeds the maximum value, it returns to "1" and incrementing runs again. If missing occurs in processing data, index will be reassigned from 1 again.	4															
(21)	Trigger occurrence flag	The trigger occurrence information is output.  <b>1</b> 1: Trigger occurred, 0: Trigger not occurred	2															
(22)	Data	Data collected by the data logging function is output corresponding to (13) Data length and (10) Data type. <ul style="list-style-type: none"> <li>When bits are specified: bit On = 1 and bit Off = 0 are output.</li> <li>When word type (signed/unsigned) or double-word type (signed/unsigned) is specified: the data values are output in the specified unit.</li> <li>When single-precision real number is specified: data value is output in the specified unit. (Page 175 Numerical value range for each output type)</li> <li>When character string type is specified: the character string with the specified size is output. If the character string terminator "0" exists in the middle of data, NULL is generated on from said point onward until the terminator of the specified size.</li> <li>When numeric string type is specified: the data value with the specified size is output.</li> <li>When time is specified: data value is output in ms units.</li> </ul>	<ul style="list-style-type: none"> <li>Bit: 2</li> <li>Word (signed/unsigned): 2</li> <li>Double word (signed/unsigned): 4</li> <li>Single-precision real number: 4</li> <li>String/numeric string: 1 to 256</li> <li>Time: 4</li> </ul>															



## Numerical value range for each output type

Describes the numerical value ranges that can be output for each output type.

### Integer type

The following table lists the numerical value ranges that can be expressed for each integer type.

Output format	Lower limit	Upper limit
Word (unsigned)	0	65535
Word (signed)	-32768	32767
Double word (unsigned)	0	4294967295
Double word (signed)	-2147483648	2147483647

### Real number type

The following table lists the numerical value ranges that can be expressed for each real number type.

Output format	Negative value		Positive value	
	Lower limit	Upper limit	Lower limit	Upper limit
Single-precision real number	-3.4028235E+38	-1.401298E-45	1.401298E-45	3.4028235E+38

## Saving and file switching

The collected data is temporarily stored in the specified internal buffer. (Page 180 Internal buffer) The data stored in the internal buffer is stored into the SD memory card at the time of a file save operation.

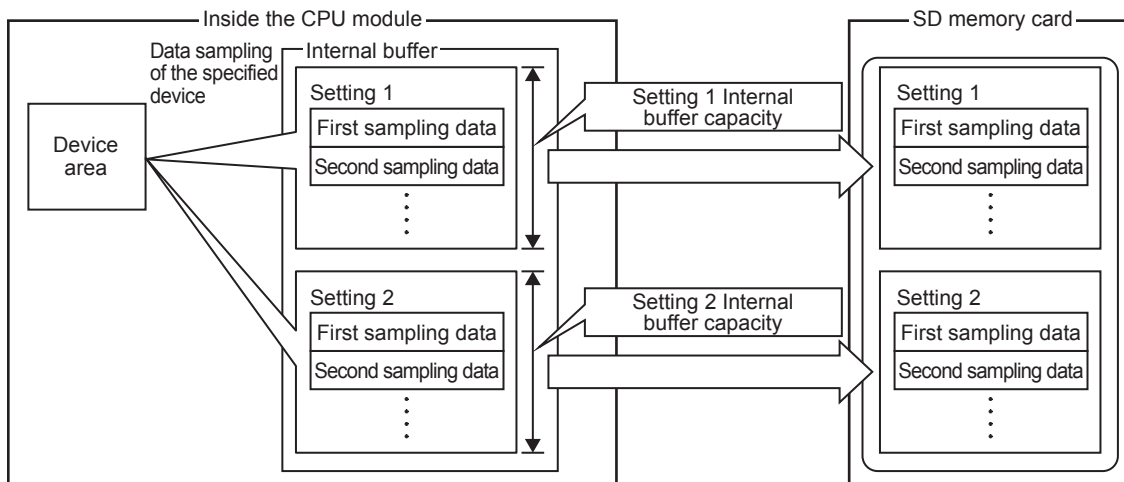

## Destinations to save data logging files

The following figure shows the folder configuration of the SD memory card attaching to a CPU module.

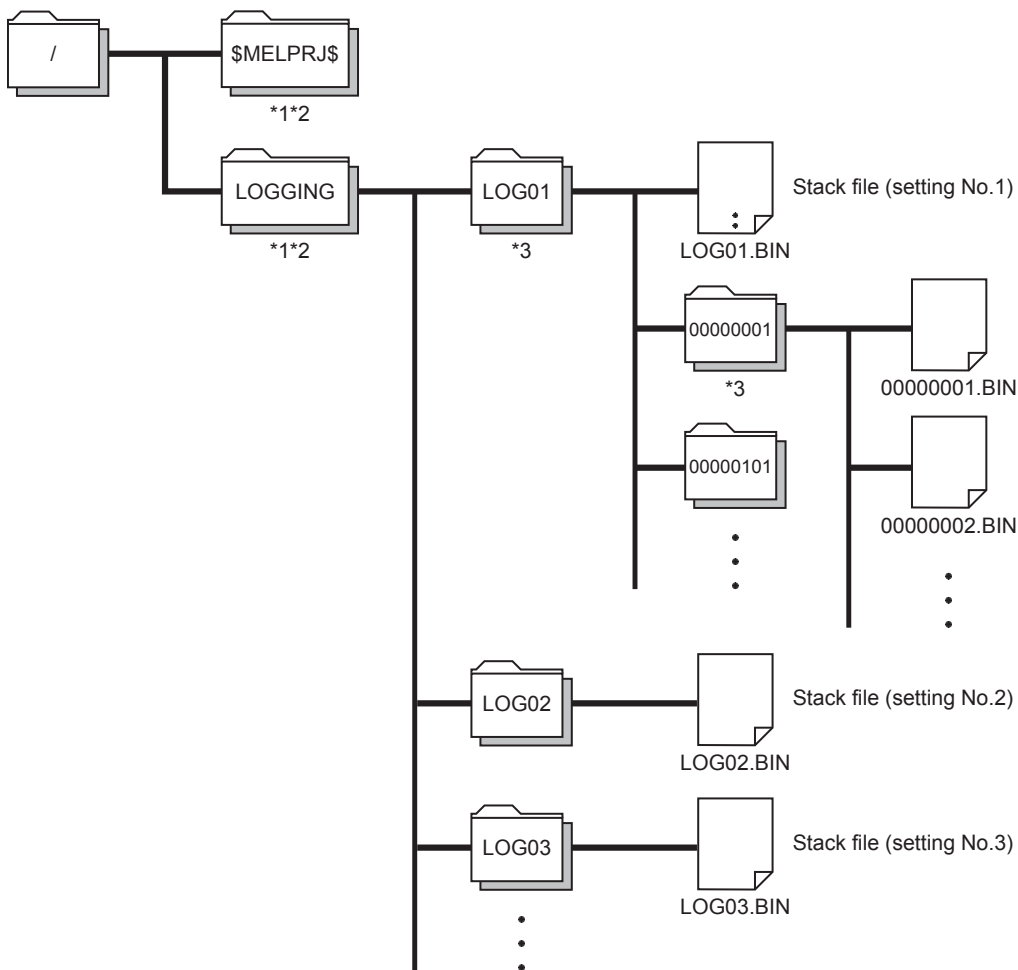

\*1 Folder names cannot be modified.

\*2 Do not create folders/files under the \$MELPRJ\$ and LOGGING folders using a personal computer or other device.

\*3 To remove unnecessary folders, use the following methods:

- Use a personal computer.
- Logging file operation (  Page 926 Logging file operation)

## Switching to a storage file

The data collected by data logging is temporarily stored in a stack file that resides in the SD memory card. The stack file can be switched to a storage file to free the space in the SD memory card.

File switching works as follows:

1. The CPU module writes collected data into a stack file (such as LOG01.BIN).
2. It changes the file name when the storage file switching condition is met.\*1
3. It creates a new stack file.
4. It continues to write collected data into the newly created stack file.

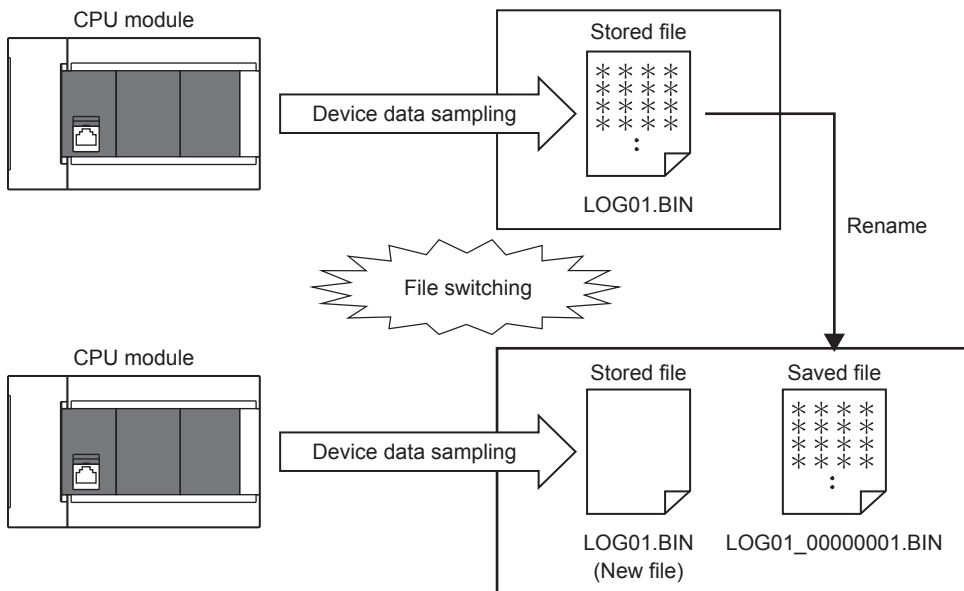

\*1 The file name format can be customized. (📄 Page 932 Save)

The file number of the most recent storage file is stored in the special register (Latest storage file number).

## File switching condition

In continuous logging, a file switching condition is selected from the following. Note that trigger logging does not require the configuration of these settings because the stack file is automatically switched to a storage file after as much data as the specified number of records is written into the stack file.

Special relay (logging data storage file switching in progress) can be used to check if storage file switching is in progress.

The following table lists the setting items that can be used to specify the file switching condition.

Setting item	Description
Number of records	Specify the number of records within the range of 1 to 65500.
File size*1	Specify the number of kilobytes within the range of 10 to 16384K bytes.
Condition specification*1	Specify conditions of the device data to be executed for file switching.

\*1 File switching occurs before the file grows beyond the specified size.

However, file switching occurs regardless of the setting when:

- The number of records has reached 65500;
- The file size has reached 16M bytes;
- The CPU module is stopped or suspended/resumed.
- Data logging is started and there is an existing stack file.

## ■ Operation example

The following figures show operation examples for various file switching timings.

At the timing © in each operation example, file switching (the processing below) is performed.

- Creating a storage file
- Deleting data in a file that is collecting data (the file becomes a file containing only a header.)

**Ex.**

Number of records: 1000

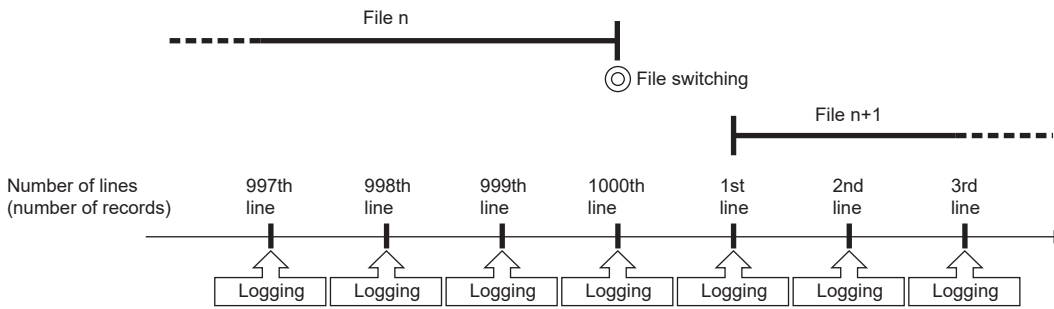

**Ex.**

File size specification: 512KB

File switching is performed before the file grows beyond the specified size. When the file format is a CSV file, since the output size of one row (record) varies depending on the data value, the timing of file switching is judged by estimating the next output size based on the current output size.

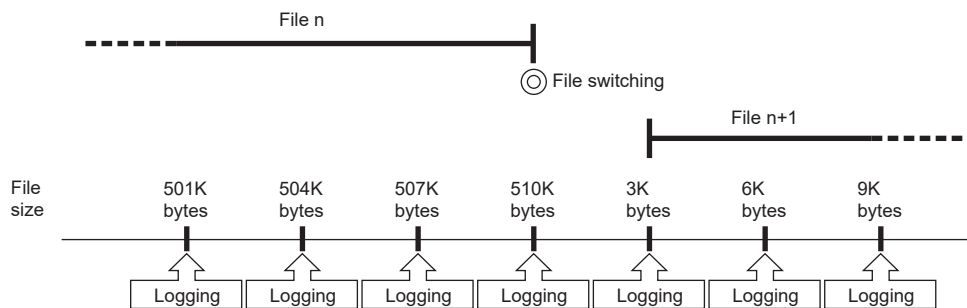

**Ex.**

Condition specification: M0=ON

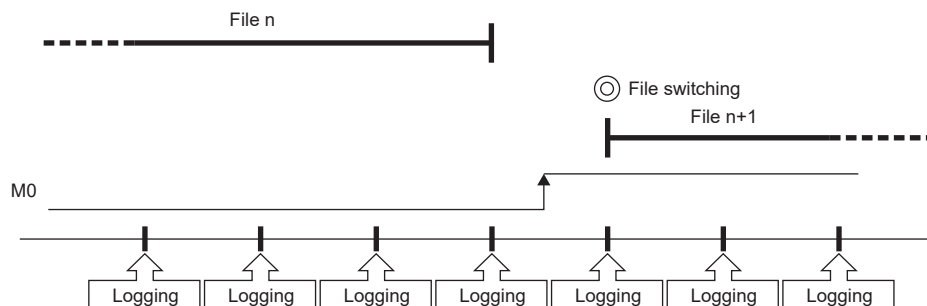

### ■Condition specification

Configure the trigger condition based on the device data value. A trigger occurs when the monitored data meets the specified condition.

- ↑: When the specified data turns off and on
- ↓: When the specified data turns on and off
- =: When the monitored data is equal to the comparison value, regardless of whether or not its current value is equal
- ≠: When the monitored data is not equal to the comparison value, regardless of whether or not its current value is equal
- ≥: When the monitored data is greater than or equal to the comparison value, regardless of whether or not its current value is equal
- >: When the monitored data is greater than the comparison value, regardless of whether or not its current value is equal
- ≤: When the monitored data is less than or equal to the comparison value, regardless of whether or not its current value is equal
- <: When the monitored data is less than the comparison value, regardless of whether or not its current value is equal
- At change: When the current value of the specified data changes

## ■ Specifying the monitored data

For the device change specification, monitored data can be specified from the devices listed in the following table. The data types that can be selected include bit/word (unsigned), word (signed), double word (unsigned), and double word (signed). If double word (unsigned) or double word (signed) is specified, a trigger occurs only when data equal to one double word is written. No trigger occurs when only the upper or lower word of a double word is written.

Type	Device <sup>*1</sup>
Bit device <sup>*2</sup>	X, Y, M, SM, L, B, F, SB, T (contact) <sup>*4</sup> , ST (contact) <sup>*4</sup> , C (contact) <sup>*4</sup> , LC (contact) <sup>*4</sup>
Word device <sup>*3</sup>	T (Current value) <sup>*5</sup> , ST (Current value) <sup>*5</sup> , C (Current value) <sup>*5</sup> , D, SD, W, SW, R, U□\G□ <sup>*6</sup>
Double-word device	LC (Current value) <sup>*5</sup>

\*1 Index modification, and indirect specification cannot be specified.

\*2 For bit devices, bit specification of word cannot be specified.

\*3 For word devices, nibble specification of bit devices cannot be specified.

\*4 To specify these devices with the CPU Module Logging Configuration Tool, use T (contact): TS, ST (contact): STS, C (contact): CS, LC (contact): LCS.

\*5 To specify these devices with the CPU Module Logging Configuration Tool, use T (current value): T or TN, ST (current value): ST or STN, C (current value): C or CN, and LC (current value): LC or LCN.

\*6 This format is supported by the FX5UJ and FX5U/FX5UC CPU modules.

## Storage file

The CPU module creates a subfolder ("storage file container folder") under the file storage folder and writes storage files to that storage file container folder. One storage file container folder can contain up to 256 storage files. When the files contained in the current storage file container folder reach the maximum number, the CPU module creates a new storage file container folder at the time of next storage file switching and begins writing storage files to that new folder. The number of files that can be contained in one file storage folder is configurable within the range of 1 to 65535.

### Point

The base folder name of a storage file container folder is an eight-digit (hexadecimal) number. This number matches the lowest of the serial numbers of the files contained in the directory. Date and time stamps can be appended to the folder name.

## Action to take when the maximum number of storage files is exceeded

Either "Overwrite" or "Stop"<sup>\*1</sup> can be selected as the action to take when the maximum number of storage files is exceeded.

\*1 This settings is not configurable for trigger logging.

### ■ When "Overwrite" is selected

When the storage file switching condition is met after the specified maximum number of storage files is exceeded, the CPU module deletes the file with the lowest serial number and creates a new file that has a serial number incremented by one from the highest serial number, allowing data logging to continue. In addition, if deleting the file with the lowest serial number results in an empty folder, the CPU module deletes that folder as well.

### ■ When "Stop" is selected

As described in the following table, the action differs depending on when the specified maximum number of storage files is exceeded.

Occurrence timing	Occurrence condition	Operation
When data logging is started	There exist more storage files than the specified maximum number when data logging is started.	<ul style="list-style-type: none"> <li>If an attempt is made to register the data logging settings from within the CPU Module Logging Configuration Tool, an error is generated, resulting in failure to run data logging.</li> <li>If an attempt is made to register<sup>*1</sup> the data logging settings from outside the CPU Module Logging Configuration Tool, the special relay (data logging error) turns on and the special register (data logging error cause) stores the cause of the error, resulting in failure to run data logging.</li> </ul>
While data logging is running	The specified maximum number of storage files is reached due to file switching upon the satisfaction of the storage file switching condition.	Data logging stops and enters into the completion state. The special relay (data logging completed) turns on to indicate that data logging is completed.

\*1 When an attempt is made to register the data logging settings again, the CPU module enters into the data logging completed state. The special relay (data logging completed) turns on to indicate that data logging is completed.

## Internal buffer

The internal buffer is a system area used to temporarily store collected data.

### ■Internal buffer capacity setting

FX5U/FX5UC CPU module can change the internal buffer capacity with an engineering tool. (☞ Page 206 INTERNAL BUFFER CAPACITY SETTING) For trigger logging, increasing the internal buffer capacity allows for a larger number of data records to be collected before a trigger, and also helps to prevent processing overflow. If the free space in the internal buffer is still insufficient after increasing the internal buffer capacity, use the following workarounds:

- Increase the data collection interval or timing.
- Reduce the number of data records to be collected.
- Lower the frequency of file switching.

### Precautions

When changing the capacity of the internal buffer during execution of the data logging function, pay attention to the followings.

- If the internal buffer capacity field for the running setting No. is left blank so that the internal buffer capacity for the setting No. will not be used, an error will occur when the data logging is resumed after it is stopped. (An error will not occur when data is written to the CPU module.)
- If the internal buffer capacity for the running setting No. is changed to a value smaller than the set value, some data may be lost when the data logging is resumed after it is stopped.

### ■Amount of internal buffer consumed

This value can be calculated by multiplying "Number of data points" by 2 bytes. Note, however, that additional space is consumed by columns configured for output, as indicated below:

- Date/time column: 10 bytes
- Data collection interval column: 8 bytes
- Index column: 4 bytes

#### Ex.

When data logging is configured to collect as much data as one setting × 128 records and output all of the columns (i.e., maximum allowable configuration):

$$128 \times 2 + (10 + 8 + 4) = 278 \text{ bytes}$$

# Data logging file transfer function (FTP server auto transfer)

This function automatically transfers data logging files to the FTP server.

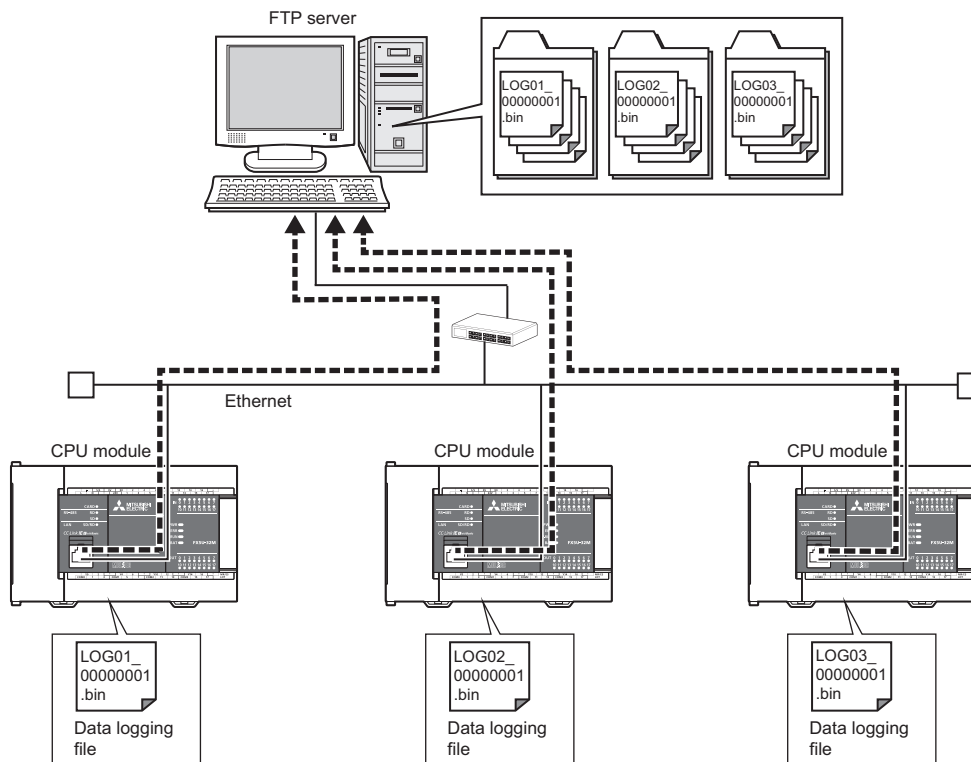

**Restriction**

Before executing the function, check the versions of the CPU module and CPU Module Logging Configuration Tool used. (Page 966 Added and Enhanced Functions)

**Point**

An FTP server is required for the data logging file transfer function. For details on the server, refer to the manual for the server used.

The operation of this function is checked with the following FTP server.

Item	Supported operating system
FTP server whose operation is checked by Mitsubishi	Microsoft® Internet Information Services (IIS) The supported operating systems are as follows: • Microsoft® Windows® 10

## Specifications

Item	Description
Transfer destination server setting	Server specification: Specified with the IP address Control port number: Variable (default: 21) • 1 to 65535
Creation of subdirectory in transfer destination server directory	Allowed*1 (The tool provides the option of not creating a subdirectory.)
File transfer method	All files are transferred in order starting from the files whose version number is smaller in each setting number.
Retry setting	Transfer continues until retry time. • 1 to 1440 minutes
File deletion at transfer completion	Allowed

\*1 Set whether to allow subfolder creation for each 256 files.

## Data logging file operation

Data logging file transfer starts when the data logging file transfer function is set using CPU Module Logging Configuration Tool, and the data logging file is saved in the CPU module by the data logging start operation. After the data logging file transfer function starts, the saved data logging file is automatically transferred to the FTP server. If the data logging operation is completed or the user has operated CPU Module Logging Configuration Tool to stop data logging, the data logging file transfer function is stopped at the completion of the transfer of the stored data logging files.

### Transfer specifications of the data logging file

- Data logging files are transferred one by one from each setting number (folder).
- If multiple files exist in multiple setting numbers, a file which has the smallest serial number in the lowest setting number is transferred.
- Only one file per setting number can be the standby file.

For example, in the following data structure, files are transferred from the file ①. (Files are transferred in order from ① → ② → ... → ⑦ → ⑧.)

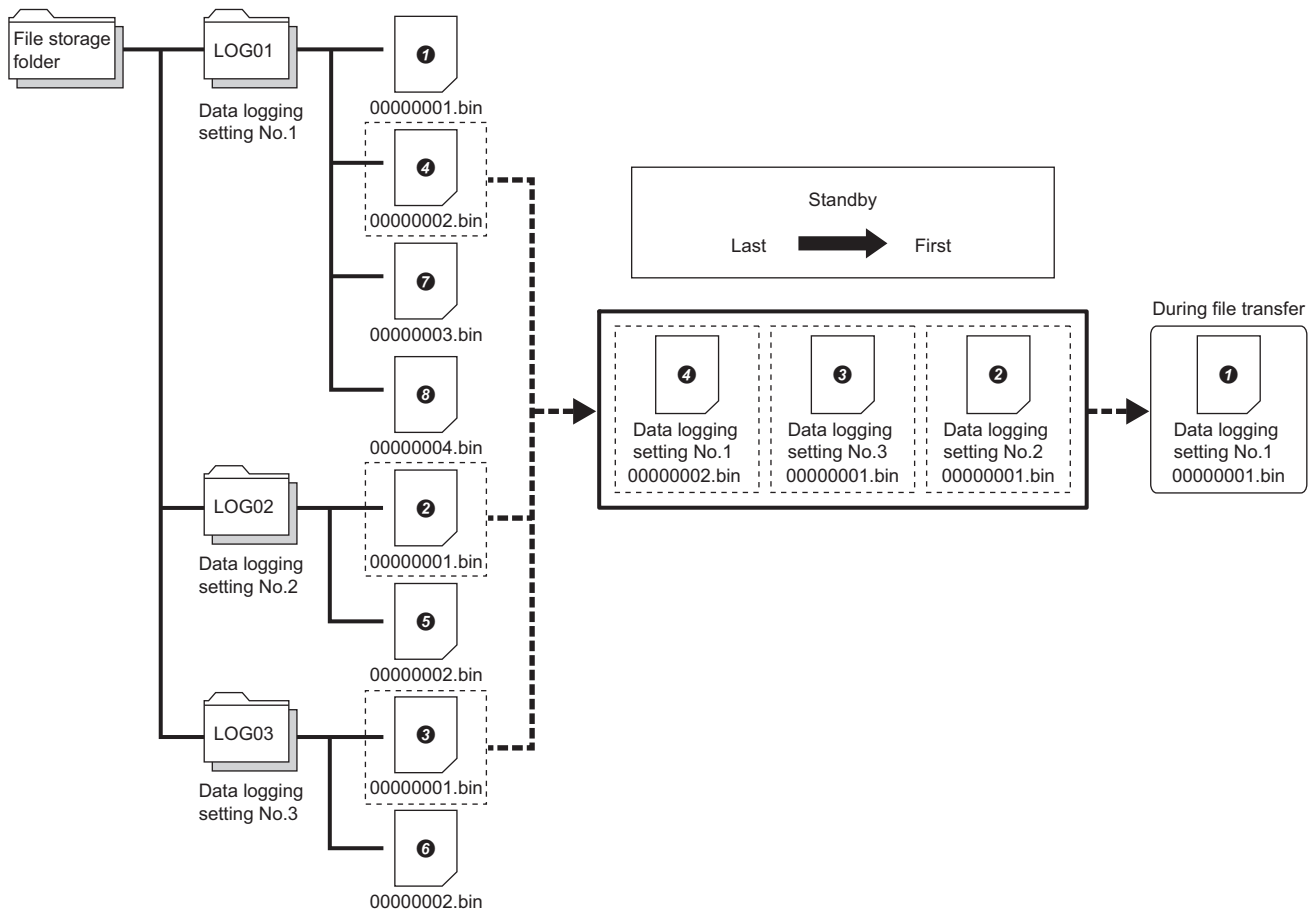

- If an error occurs during a file transfer, the data logging file caused the error is omitted from the standby files. A following file in the same setting number becomes a new standby file.
- If the file switching timing occurs during a file transfer, the data logging file created by the file switching becomes a standby file.
- If the data logging operation is completed or the user has operated CPU Module Logging Configuration Tool to stop data logging, the data logging file transfer is stopped at the completion of the transfer of the stored data logging files.



### Start timing of file transfer

After data logging is started, the transfer of the files created at the file switching timing in the data logging function starts. When the transfer is started, the special relay (data logging file transfer execution status flag) for each setting number turns on. They turn off after all the files are transferred.

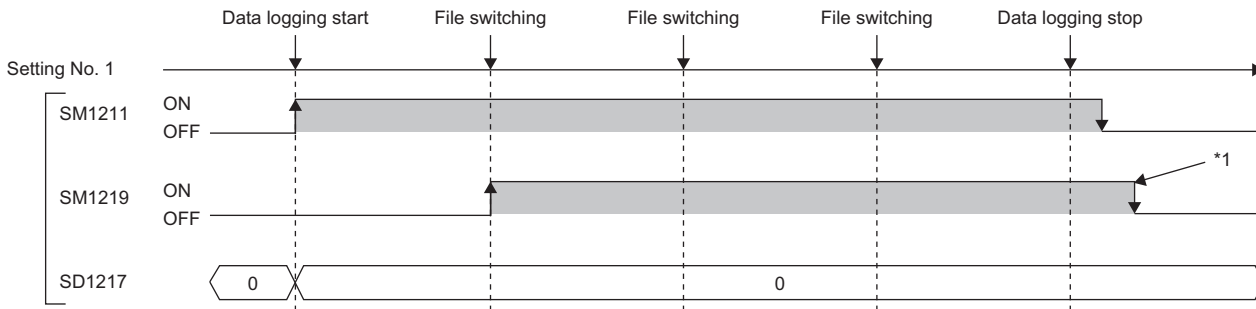

- SM1211: Data logging setting No.1 Data logging start
  - SM1219: Data logging setting No.1 Data logging file transfer execution status flag
  - SD1217: Data logging setting No.1 Data logging file transfer error cause
- \*1 SM1219 does not turn off until all the files are transferred.

## FTP server setting

### FTP server setting

Set the login name, password, and home directory to the FTP server. Authorize the user of the data logging file transfer function to read/write files. (Manual for the server used)

### Engineering tool setting

1. Set the IP address of the CPU module. Set the subnet mask and default gateway as necessary.

[Navigation window] ⇒ [Parameter] ⇒ CPU module ⇒ [Module Parameter] ⇒ [Ethernet Port] ⇒ [Basic Settings] ⇒ [Own Node Settings] ⇒ [IP Address]

### Setting of CPU Module Logging Configuration Tool

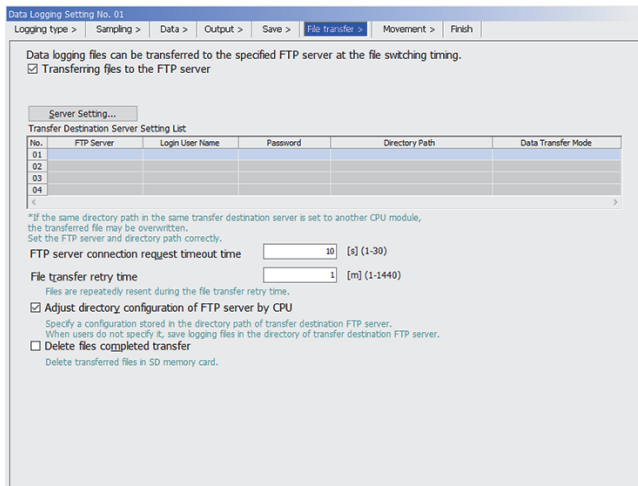

1. Select the "Transferring files to the FTP server" check box in "File transfer" of CPU Module Logging Configuration Tool. (Page 154 Setting data logging)
2. Click the [Server Setting] button.

3. Configure the server setting.
4. Click the [File Transfer Test] button to execute the file transfer test to the FTP server. Before operating the system, execute the file transfer test and ensure the connection with the FTP server. (Page 184 File transfer test)
5. Set the timeout time and other items on the "File transfer" window. (Page 185 Setting on the "File transfer" window)
6. Write the setting from CPU Module Logging Configuration Tool. (Page 922 Write logging setting)
7. The transfer is started at the logging file switching timing. (Page 183 Start timing of file transfer)

## File transfer test

Check the communication status and settings by transferring a test file from the CPU module to the FTP server. The file transfer to the FTP server can be checked before system operation.

### Procedure for the file transfer test

The following describes the procedure for the file transfer test.

1. Configure the transfer destination server setting in CPU Module Logging Configuration Tool. (Page 183 Setting of CPU Module Logging Configuration Tool)
2. Click the [File Transfer Test] button in the "FTP Setting" window to execute the file transfer test.
3. Check the execution result.
4. Check that the test file is transferred to the FTP server.

### Structure of a test file

The following table lists structures of a test file to be transferred to the FTP server.

Item	Description	Example
Test file name	MELSEC_CPU_FTP_TEST_**.txt ** indicates the data logging setting number (two digits, with zero-padding).	For setting No.1 MELSEC_CPU_FTP_TEST_01.txt
Contents of the test file	The IP address of the CPU module, test execution date, and test execution time are described. For the date and time, the clock data in the CPU module is used.	For IP address: 192.168.3.39, date: October 01, 2017, time: 11:22:33 192.168.3.39_20171001_112233

### File transfer test specification

- The FTP server connection request timeout time is fixed to 10 seconds.
- Even if the file transfer test fails due to a communication error, the retry is not executed.
- Even if the file transfer test fails, the error is not stored in the file transfer error history. (Page 936 File Transfer Error Log)

## ■Precautions

- File transfer tests cannot be executed simultaneously with another configuration tool. Execute the file transfer test after the file transfer test from another configuration tool is completed.
- If the engineering tool is operated or monitored from the same connection destination of the same computer during the file transfer test, the operation or monitoring will be executed after the file transfer test completion. If a communication timeout error occurs due to the execution of the file transfer test, extend the communication time check period on the engineering tool.
- If the file transfer test is attempted while the file is being transferred, the file transfer test will be executed after the file is transferred. Therefore, if the file size of the data logging file during file transfer is large, it takes time until the execution of the file transfer test, and a communication timeout error may occur in the CPU Module Logging Configuration Tool. In this case, extend the communication time check period on the CPU Module Logging Configuration Tool.

## Setting on the "File transfer" window

### ■FTP server connection request timeout time

Set the waiting time from when the connection request from the CPU module to the FTP server is sent to when the response is received. If no response is received from the FTP server within the connection request timeout time, an error occurs.

### ■File transfer retry time

Set the time to retry the file transfer when the file transfer fails due to an error caused by communication failure such as the network error between the CPU module and the FTP server.

The data logging file failed to be transferred is in the standby state and the retry starts. The file is resent until the file transfer retry time elapses. Even when the file transfer fails again due to a communication error, the file will be on standby for the reverse transfer again without an error of the data logging file transfer function.

Ex.

When a data logging file of the data logging setting No.1 has not been transferred due to a network failure

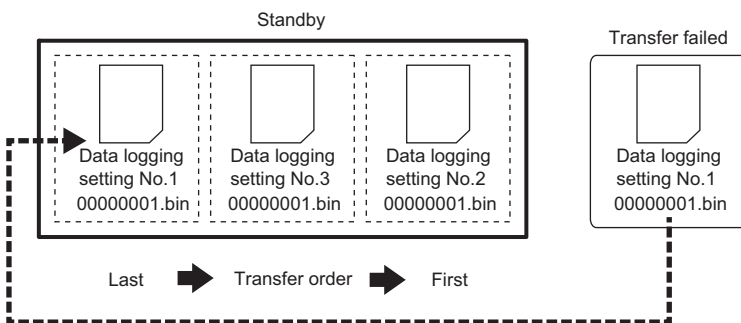

The retry ends when the network is recovered and retry of the file transfer succeeds.

Retry ends if the following conditions are met during retry. For such a case, an error will occur in the data logging file transfer function.

Conditions for ending retry	Operation when retry ends
If data logging file transfer fails due to something other than a communication error	The same error as the last resend occurs.
If the file transfer retry time has elapsed when the resend fails	The same error as the last resend occurs.
If file transfer is interrupted due to  Page 187 Stopping the data logging file transfer during retry	An error will occur in the data logging file transfer function (file transfer stop: 4C0E).

### ■ Matching the folder structure of the transfer destination FTP server with the CPU module

When the data logging file is transferred, the directory is automatically created in the specified folder path of the FTP server so that the structure is the same as the storage destination (  Page 176 Destinations to save data logging files).

If the same file exists, the file will be overwritten.

- When the folder structure is matched with the CPU module

The folder path (1) specified in the server setting, folder structure (2), logging files transferred (3).

In the folder structure (2), subdirectories (4) are created.

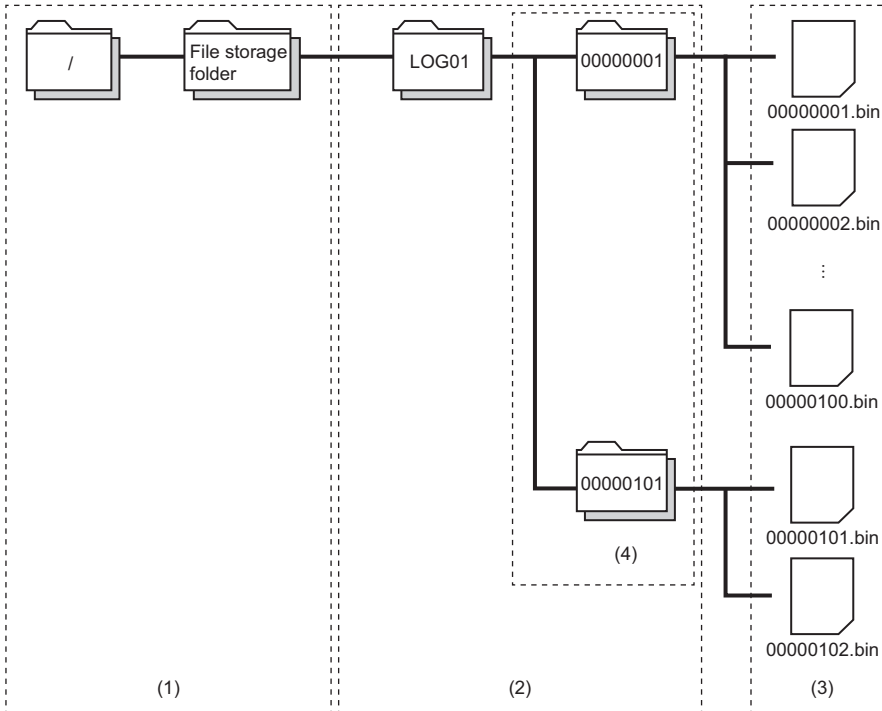

- When the folder structure is not matched with the CPU module

The folder structure of the FTP server consists of the storage destination structures of the data logging file excluding the subdirectory.

The folder path (1) specified in the server setting, folder structure (2), logging files transferred (3).

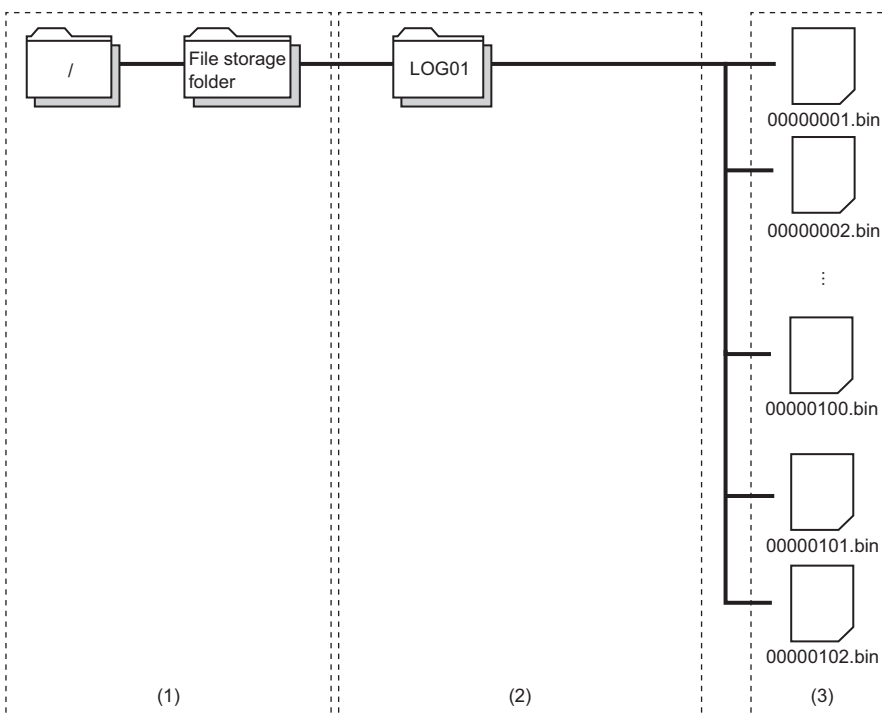

## ■Deleting files completed transfer

At the completion of data logging file transfer, transferred files are automatically deleted. If there is no file in the saved file storage folder (subdirectory) as a result of the file deletion, the saved file storage folder (subdirectory) is deleted while data logging is stopped.

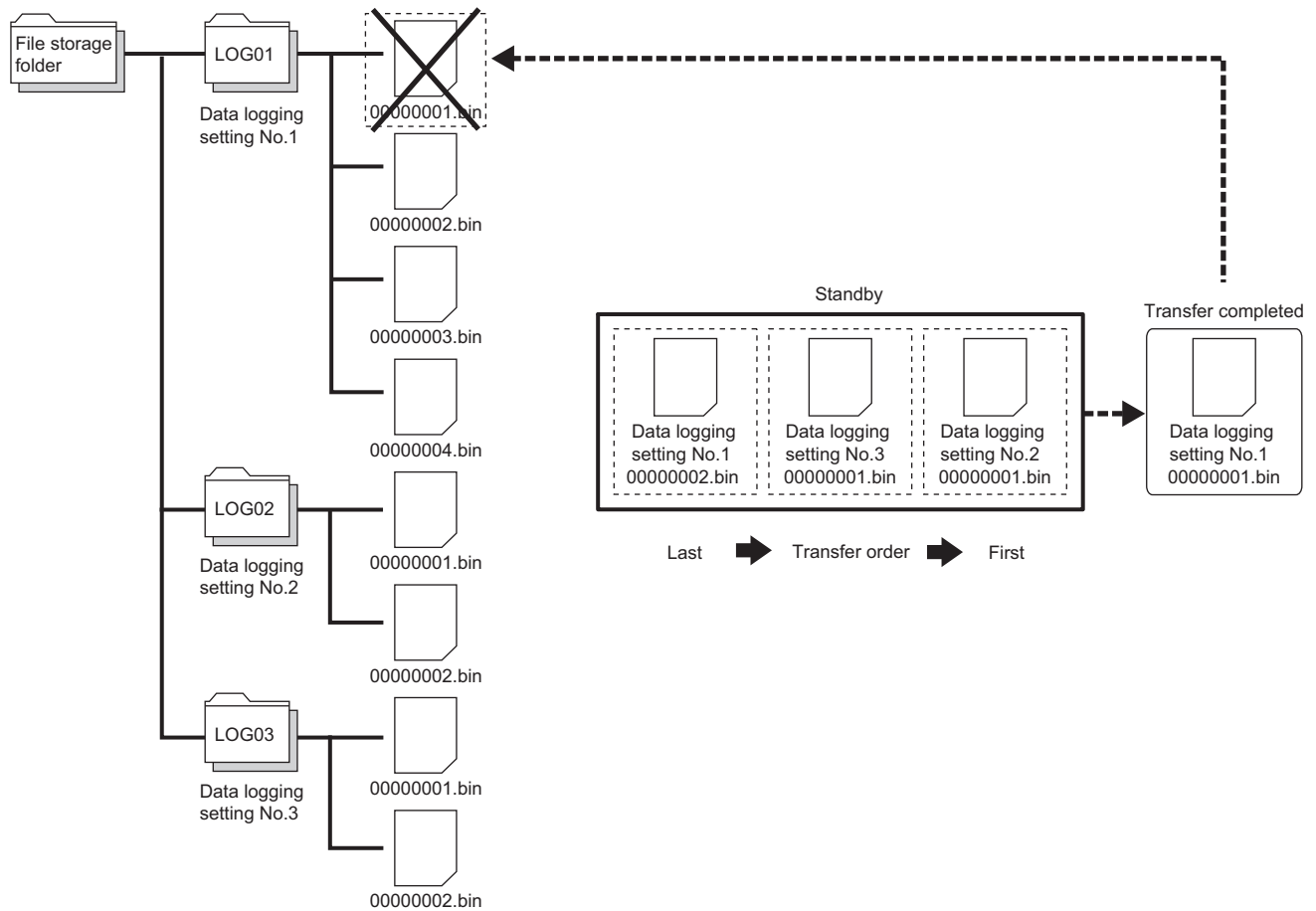

### Point

- Even if "Delete files completed transfer" is specified, data logging operates (overwrites or stops) using the settings when the number of files stored by the data logging function exceeds the maximum value of the number of files to be saved.

## Data logging file transfer status

The file transfer status, the data logging name, and the IP address of the file transfer destination FTP server can be checked. They can be checked on the data logging file transfer status window of CPU Module Logging Configuration Tool. (Page 935 Data Logging File Transfer Status)

## File transfer error log

Error history including the date and time of error occurrence, data logging No., and the error codes can be checked. They can be checked on the file transfer error log window of CPU Module Logging Configuration Tool. (Page 936 File Transfer Error Log)

## Stopping the data logging file transfer

After data logging is stopped, the data logging file transfer stops when no standby file for the data logging file transfer is left. However, after data logging is stopped, if the data logging file transfer is being retried and does not stop, the file transfer in progress can be stopped by following the procedure below.

1. Set the data logging setting number for SD1203 (Data logging file transfer stop information). Multiple data logging setting numbers can be set for SD1203.
2. Turn off and on SM1203 (Data logging file transfer stop request). When multiple data logging setting numbers are specified for SD1203 and SM1203 is turned off and on, SM1203 turns off after the data logging file transfer of all the data logging setting numbers stops.
3. At the completion of the file transfer stop processing, an error is stored in each data logging file transfer error cause of the files being transferred and in the standby (retry) state.

For the file transfer stopped by the stop request, files which have not been transferred cannot be transferred even if the data logging of the same setting number is restarted and the file transfer is executed. To transfer a file that has not yet been transferred, use the FTP server function to transfer the file to the server after data logging file transfer has stopped.

#### Point

- When the data logging status of the data logging setting No. which has been set by SD1203 (Data logging file transfer stop information) is other than stop, or the data logging file transfer is not enabled in the data logging setting, turning off and on SM1203 (Data logging file transfer stop request) does not execute the stop processing and SM1203 turns off.
- When the data logging is in the collection completed state or when an error occurs, file transfer cannot be stopped by SM1203 (Data logging file transfer stop request). To stop file transfer, stop the data logging function.

## Setting the operation at the time of transition to RUN

This function configures the operation of data logging that occurs when the user performs the following operations (transition to RUN) after the data logging setting are registered. (  Page 933 Logging operation)

- Turning off and on the CPU module and switching to the RUN mode
- Resetting and running the CPU module
- Stopping and running the CPU module

#### Point

The operation at the time of transition to RUN can be set individually for each setting number (1 to 4).

### Operation at the time of transition to RUN

The operation at the time of transition to RUN can be set to either of the followings.

#### ■Auto start

After the user performs one of the operations listed above, data logging automatically starts when the operating status of the CPU module changes from STOP to RUN.

#### Point

To first start data logging, the user must instruct the CPU Module Logging Configuration Tool to start data logging.

#### ■Start by user operation

After the user performs one of the operations listed above, the data logging state is switched to "Waiting start Not collected" when the operating status of the CPU module changes from STOP to RUN. To start data logging again, the user must instruct the CPU Module Logging Configuration Tool to start data logging.

### Data logging operation that occurs after operating status of CPU module has changed

Data logging does not continue when the operating state of the CPU module changes from RUN to STOP or PAUSE after it has been started. The data logging state changes to "Waiting RUN Not collected" and data collection is stopped.

# 20.6 Precautions

This section describes precautions to take when using the data logging function.

## Missing data

The term "missing data" means that some of the collected data is missing, resulting in data discontinuity.

Missing data occurs under the following conditions:

Item	Description
Data logging function processing time	When data logging is executed by specifying for the collection interval a time interval shorter than the processing time required by the CPU module for data storage.
Processing overflow	<ul style="list-style-type: none"> <li>When the internal buffer responsible for tentatively storing the logged data is unable to store new logged data because the SD memory card does not store data</li> <li>When you attempt to register the data logging while the CPU module is in the process of logging collecting, collecting before trigger or collecting after trigger</li> </ul>
Operations for the CPU module	The CPU module has been stopped and run with "Operation at transition to RUN" set to "Auto Start". The CPU module has been turned off and on with "Operation at transition to RUN" set to "Auto Start". The CPU module has been reset and run with "Operation at transition to RUN" set to "Auto Start".
Operation from engineering tools, CPU Module Logging Configuration Tool, and external devices via protocols such as SLMP	<ul style="list-style-type: none"> <li>When the CPU module is suspended and restarted, and operation for displaying the logging state is performed from CPU Module Logging Configuration Tool</li> <li>File read<sup>*1</sup>, write, delete, or verification</li> </ul>

\*1 The following operation also is included:

- Online operation which displays data by operation such as read from the PLC performed from an engineering tool (retrieval and display of a list of files on the CPU module)
- View of the event history (retrieval of the event history from the CPU module)

If the data logging file transfer function has been used, logging collection performance deteriorates. Therefore, the frequency of missing data may increase.

## ■Data logging function processing time

The data logging function processing time indicates the minimum time value that allows data collection without data loss when executing data logging.

It shows the collection interval at which data can be collected under the following conditions.

- Logging type = continuous logging
- Scan time = 5ms
- Internal buffer capacity setting = 80K bytes as per one setting (default setting)
- Collection setting = Time specification (data collection at time interval)
- Data setting = Data register (D) (Data type: Word (signed))
- Binary Output setting = Output date (output format is default), Output data sampling interval, Output index, Output comments
- Save setting = Operation when exceeds the number of files: Overwriting, File switch timing: 10000
- SD memory card: NZ1MEM-4GBSD used

Points		Collection interval where data can be collected
8 points	(8 points × 1 setting)	10ms
16 points	(16 points × 1 setting)	15ms
64 points	(64 points × 1 setting)	45ms
128 points	(128 points × 1 setting)	100ms
256 points	(128 points × 2 setting)	150ms
512 points	(128 points × 4 setting)	250ms

## Precautions

- If the SD memory card is accessed frequently during operations with the engineering tool or CPU module logging setting tool or with operations using FTP, set a longer collection interval than the interval given above.
- If a load on Ethernet communication is heavy for such a reason as using socket communication and SLMP communication, set a longer collection interval than the interval given above.

## ■ Processing overflow

In normal cases when the usage of the internal buffer reaches the specified maximum capacity, the CPU module overwrites the data stored in the storage memory on a first-in first-out basis. If the internal buffer becomes full before all of the data stored in it is saved to the storage memory, however, the CPU module does not overwrite the existing data and stops storing data in the internal buffer, thus resulting in missing data. This situation is referred to as processing overflow. Upon the occurrence of overflow, the special register (Number of processing overflow occurrences) stores the number of times when processing overflow occurred.

## Errors generated during data logging

No diagnostic error occurs if an error occurs during data logging, the SM applicable to the special relay (data logging error) setting No. turns on, and the error cause is stored in the SD applicable to the special register (data logging error cause) setting No. Note that if the data logging with the special relay fails at the time of register/clear, the cause of occurred error is stored in a special register (the data logging register/clear error code) applicable to the setting No.

## Mutual exclusion of the data logging function

This section describes the mutual exclusion of the data logging function.

### ■ When another function is executed during the execution of the data logging function

The following table lists the cases when another function is executed during the execution of the data logging function.

Function that has been already executed	Function to be executed later	Operation
Data logging function	Data logging function	When the data logging is started using the CPU Module Logging Configuration Tool to the same data logging setting number, the data logging to be executed later cannot be executed. However, the data logging to be executed later can be executed to a data logging setting number different from the data logging setting number currently being executed. For the execution of multiple data loggings, the data logging settings stored in different target memory areas cannot be executed at the same time.
	Memory dump function	The data logging function and memory dump function cannot be used simultaneously.
	Data backup function	The data backup function cannot be executed while a logging setting file is being written/ deleted or a logging setting is being registered/cleared.
	Data restoration function	The data restoration function cannot be executed while a logging setting file is being written/ read/ deleted or a logging setting is being registered/cleared.

### ■ When the data logging function is executed during the execution of another function

The following table lists the cases when the data logging function is executed during the execution of another function.

Function that has been already executed	Function to be executed later	Operation
Memory dump function	Data logging function	The data logging function and memory dump function cannot be used simultaneously.
Data backup function		While the data backup function is being executed, a logging setting file cannot be written/ deleted and a logging setting cannot be registered/cleared.
Data restoration function		While the data restoration function is being executed, a logging setting file cannot be written/ read/ deleted and a logging setting cannot be registered/cleared.

## Locations from which data logging can be performed

Data logging cannot be performed from multiple locations to the same setting number. The CPU module supports data logging performed concurrently at a maximum of 4 locations assigned to setting numbers 1 to 4.



## Retention and clearance of data logging settings

The data logging settings registered in the CPU module are latched and thus survive across a power cycle (power off and on) or reset of the CPU module in normal cases. In the following cases, however, the data logging status is cleared to the unregistered state and therefore the setting data must be written again:

- The CPU module is turned off and on or reset without an SD memory card that contains the data logging setting file.
- The replaced SD memory card does not contain the data logging setting file and the CPU module is turned off and on or is reset.\*1

\*1 If the data logging setting file contained in the replacement (new) SD memory card is different from that contained in the replaced (old) SD memory card, the data logging setting file contained in the replacement SD memory card becomes registered.

## Stopping/suspending data logging

After data logging is stopped or suspended from within the CPU Module Logging Configuration Tool or special relay, all the data in the internal buffer is written into the target memory. If a small number of records or a small file size is specified as part of the storage file switching condition, writes to the target memory may take a longer time.

## Operation against the failure to register data logging setting files

When an attempt to register multiple data logging setting files at the same time is made and fails for some of them, the CPU module runs data logging for the setting files that have been successfully registered.

## Numbering of the storage files used during data logging

### ■If one or more numbered storage files already exist in the specified file storage folder

The new file is given a file name that uses a number incremented by one from the highest number among the existing files. If the data logging file transfer setting is set to delete the file after transfer, numbering to new storage files starts from 1 because no files exist in the folder at the time of restarting data logging.

### ■If one or more storage file folders exist but no storage files in them

A new file is stored into a folder with the lowest number and given the same number as the folder.

Also, if the file transfer setting is set to delete the file after transfer, the folder will not be deleted during logging, but will be deleted if there are no files in the folder when the logging is stopped.

However, if there are 258 or more folders under the said conditions, a new folder is created and the file is given the same number as the new folder.

When the file transfer setting is set to delete the file that has been transferred, the existing folders are deleted if no files exist in the folders at the time of the data logging stop. (The existing folders are not deleted while the data logging is in progress.)

## Operation that occurs while collected data is stored in the target memory

If one of the following operations is performed while collected data is stored in the target memory, any unsaved data is cleared and not reflected to the results:

- Turning power of the CPU module off and on
- Reset

If one of the following operations is performed, unsaved data continues to be stored in the target memory:

- Stopping the CPU module
- Stopping/suspending data logging from within the CPU Module Logging Configuration Tool
- Issuing the LOGTRGR instruction

## Creating files and folders

Under the "LOGGING" folder that contains data logging setting files and data logging files, do not attempt to create files or folders using a personal computer or other device. Doing so may result in deletion of files and folders.

## Changing the clock data

Whatever changes, such as advancing or reverting the clock, are made to the clock data of the CPU module during data logging, the CPU module performs data collection at the specified collection interval/timing, but the date/time column in the output file reports the changed clock data.

## Access to the SD memory card

If data logging is performed with a small setting of the data collection interval/timing or with a large number of records to be collected, access (read/write) to the SD memory card occurs so frequently that a delay occurs in completing the access. To avoid such a delay, use the following workarounds:

- Increase the data collection interval/timing.
- Reduce the number of data records to be collected.
- Lower the frequency of file switching.

## Changing the operating status of the CPU module

The operating state of the CPU module should not be changed until the completion of the following operations and registrations:

- Save of the data in the internal buffer by changing the state of the CPU module from RUN to STOP or instructing the CPU Module Logging Configuration Tool to stop or suspend the CPU module
- Registering multiple data logging sessions' settings<sup>\*1</sup>
- Registering data logging settings with any unused folders remaining in the storage memory<sup>\*1</sup>

<sup>\*1</sup> Data logging settings are also registered when the CPU module is stopped and run.

### Point

- To shorten the time required to register multiple data logging sessions' settings, reduce the number of data logging sessions.
- To shorten the time required to register data logging settings with any unused folders remaining in the storage memory, delete the unused folders before registration.

## File operation during execution of data logging

Describes file operation during execution of data logging.

Target file	File operation	Operation
Data logging setting file	Write	During execution of data logging, it is not possible to write or the delete data logging setting file being used.
	Delete	
	Initialize	During execution of data logging, it is not possible to initialize the memory storing the data logging setting file being executed.
	Folder delete	Folders cannot be deleted from the \$MELPRJ\$ folder in which the data logging setting file is stored.
Data Logging File	Write	During execution of data logging, it is not possible to write or delete data, or delete folders corresponding to the data logging file being used.
	Delete	
	Folder delete	
	Initialize	During execution of data logging, it is not possible to initialize the memory storing the data logging file being executed.

## About remote operation

When remote RUN is performed while the data logging function is in the following execution status, the remote RUN may fail. In that case, wait for a while and retry remote RUN. If remote RUN still cannot be executed, check whether remote RUN is acceptable and retry remote RUN.

Execution state of data logging function	The situation to accept remote RUN
Data saving into memory card in progress	No special relay (Data logging data saving into memory card in progress) is on.
Registration of the data logging setting from CPU Module Logging Configuration Tool in progress	The special relay (data logging preparation) and the special relay (data logging start) corresponding to the setting number of the data logging setting, which is being registered in the way shown in the left column, are on.

## RUN operation through switching operation or the RUN contact

During execution of data logging, when the status of the CPU module is switched from STOP to RUN with the RUN/STOP/RESET switch, or when remote STOP to RUN operation of the RUN contact, it may take time to return to the RUN state.

## Data logging file transfer function (FTP server auto transfer)

### ■Starting data logging during logging result file transfer

Data logging with the same setting number cannot be started during transfer to the FTP server. If it is started, a file transfer error (4C0DH) will occur. Start it after the transfer is completed.

### ■Powering off or reset operation during file transfer

- A standby file waiting to be transferred will not be transferred even when data logging resumes the next time. It will be transferred from the logging file created when data logging resumes.
- The transfer file will not be transferred correctly, and the file being transferred may remain.

### ■If the SD memory card is removed during file transfer

If the SD memory card is removed without the SD memory card forced disable function being executed during file transfer, note the following.

- File transfer will stop because a logging function error (4C02H)<sup>\*1</sup> will occur. Therefore, it is necessary to insert the SD memory card again and restart the logging function to resume file transfer.
- A standby file waiting to be transferred will not be transferred even when data logging resumes the next time. It will be transferred from the logging file created when data logging resumes.

\*1 When file transfer is set, a file transfer error (4C0BH) will occur if the file is being transferred (file is being accessed).

### ■Ethernet communication

- The data logging file transfer function uses the built-in Ethernet port of the CPU module when transferring data logging files to the FTP server. Therefore, use the engineering tool to set the IP address for the module parameter.
- The data logging file transfer function dynamically uses the own station port numbers F230H to FFFE H when performing FTP communication. During execution, therefore, do not specify own station port numbers F230H to FFFE H of the socket communications function connection establishment instruction (SP.SOCOPEN). Otherwise, the instruction may be completed with an error.
- For the SLMP communications, port numbers set with the parameters take priority from after power-on or reset is canceled until power-off or reset. Therefore, even if F230H to FFFE H are specified for the own station port number in parameter settings, the SLMP communications will not be affected by the data logging file transfer function.
- File transfer processing time differs depending on the Ethernet line load ratio (network congestion), operating status of other communication functions (such as MELSOFT connection, SLMP communication, socket communication, CC-Link IE Field Network Basic) and system configuration.
- During data logging file transfer using the data logging file transfer function, the Ethernet communication load increases.
  - When other communication functions such as MELSOFT connection and SLMP communications are executed using UDP, data may be lost at UDP reception and timeout and other errors may occur. Therefore, the communication using TCP is recommended while the data logging file transfer function is running.
  - When other communication functions such as MELSOFT connection and SLMP communications are executed, their completion are delayed.

### ■Transfer destination FTP server

- The FTP server software uses the internal clock data of the FTP server to determine the creation date and time and update date and time of the data logging file transferred to the FTP server. Therefore, the creation date and time and update date and time of the data logging file in the CPU module and the data logging file transferred to the FTP server may differ.
- The login user set in the transfer destination server setting must have file access permissions (file write permissions, directory creation permissions).
- If a communication error, a file access error, or a file transfer stop error occurs during the file transfer, the data logging file being transferred may remain in the FTP server. Since the data cannot be guaranteed for the data logging file with a file transfer error, check the file transfer error history and do not refer to the data logging file with a file transfer error.
- Even when the data logging file is transferred successfully, a data logging file transfer error occurs if the operation to stop data logging file transfer function is performed before logging out from the FTP server or logout fails.

### ■Power off to on/reset operation

- If the CPU module is powered off and on or is reset during data logging file transfer, data logging files being transferred may remain in the FTP server.
- The files being transferred and in the standby (retry) status when the CPU module is powered off or reset are not transferred again after the power-on or reset is canceled.

### ■Stopping data logging file transfer

- If file transfer is stopped by a data logging file transfer stop request after data logging stops, the next time data logging with the same setting number is started, the logging file saved by file switching will be transferred. Therefore, files which have not been transferred will not be transferred by a stop request. For standby files, use the FTP server function to transfer them to the server.
- When "Overwrite" is selected for the operation for when the number of files exceeds the maximum number of files to be saved in the data logging function, the file being transferred may be overwritten and a file transfer error may occur if the file transfer speed is slow. To ensure the file transfer, set a large value for the number of files to be saved and select "Stop" for the operation for when the number of files exceeds the maximum number of files to be saved, so that the files that have completed transfer are to be deleted.

### ■File operation

- If a data logging file in the CPU module is read by a tool such as GX LogViewer during the data logging file transfer, the file being read cannot be deleted and the deletion process goes into retry, which may cause the data logging file transfer to stop. Do not read the logging file in the SD memory card during transfer, but read the file transferred to the server.
- If a file is accessed (read/written) during the data logging file transfer, the more files to transfer, the slower the file access (read/write) will be completed.

### ■Simultaneous use with data logging file transfer function

If the file transfer function instruction (SP.FTPGET/FTPPUT) and the data logging file transfer function are used at the same time:

- If the function executed later is the file transfer function instruction, the function instruction will not be executed.
- If the function executed later is the data logging file transfer function, the transfer function will be executed after the file transfer function instruction is completed.

Do not use the FTP server function and data logging file transfer function at the same time.

## 20.7 SD Memory Card Life and Replacement

This section describes the life of the SD memory card used for the data logging function and the replacement procedure.

### SD memory card life

An SD memory card has a life (restriction on writing data). The following shows the calculation method of an SD memory card life when the data logging function is used. Note that the actual life of the card varies depending on usage conditions and environment. Therefore, use the calculated life as a rough standard for the replacement of the card.

#### Calculation formula of SD memory card life

SD memory card life (year) = Total size of data that can be written (G bytes) ÷ Size of data to be written per year (G bytes/year)

#### Total size of data that can be written

Capacity × Number of writes

For the capacity of applicable SD memory cards and the number of writes, refer to the following.

📖 MELSEC iQ-F FX5S/FX5UJ/FX5U/FX5UC User's Manual (Hardware)

## Size of data to be written per year

The size of data to be written per year is obtained by the following formula.

$$\text{Size of data to be written per year (G bytes/year)} = ((DS1^{*1} + 6144) \times DN1 + \dots + (DSn^{*1} + 6144) \times DNn + (DCS1^{*1} + 6144) \times DCN1 + \dots + (DCSn^{*1} + 6144) \times DCNn) \div 1073741824$$

\*1 Round up DS<sub>n</sub> and DCS<sub>n</sub> to a multiple of 512.

DS<sub>n</sub>, DN<sub>n</sub>, DCS<sub>n</sub>, and DCN<sub>n</sub> are obtained as follows.

### ■Data logging data size per record (DS<sub>n</sub>)

CSV file output format: Refer to the data. (📄 Page 170 CSV file format)

Binary file output format: Refer to the data. (📄 Page 172 Binary file format)

### ■Number of records for data logging per year (DN<sub>n</sub>)

Continuous logging:  $DNn = 60 \times 60 \times 24 \times 365 \div \text{Collection interval and timing (seconds)}^{*1} \times \text{Operating rate}^{*2}$

Trigger logging:  $DNn = \text{Total number of records}^{*3}$

\*1 The value that is determined depending on the condition set in "Sampling" when "Continuous logging" is selected for the logging type. (When the value is determined in milliseconds, convert the value into seconds.)

\*2 Calculate the ratio using the operating time per year of the CPU module. For example, if the operating time per year is 5000 hours, the operating rate is calculated as follows:  $5000 \div (24 \times 365) = 0.57$ .

\*3 The value set in "Number of logging lines" when "Trigger logging" is selected for the logging type.

### ■Header size of data logging (DCS<sub>n</sub>)

CSV file output format: Refer to the header. (📄 Page 170 CSV file format)

Binary file output format: Refer to the header. (📄 Page 172 Binary file format)

### ■Number of file switching times for the data logging per year (DCN<sub>n</sub>)

Calculate this number with an estimated number according to the save setting of the data logging and system operations. For example, when 1000 records are set in "Number of records" of "File switching timing" in the save setting and "Each scanning cycle" is specified for "Sampling interval" in the sampling setting, the time interval of the file switching is obtained by multiplying the scan time by 1000. Therefore, the number of file switching times for the data logging per year is obtained by the following formula:  $60 \times 60 \times 24 \times 365 \div (\text{Scan time (second)} \times 1000)$ .

## SD memory card replacement

SD memory cards can be replaced using the SD memory card forced disable function even while data logging is in progress. (📄 Page 228 SD Memory Card Forced Stop) This function works by disabling data writes to the SD memory card while allowing data collection to continue. (Data collection continues in accordance with the settings registered when data logging is started.)

### Point

If SD memory card replacement causes processing overflow, make adjustments by changing the collection interval, internal buffer capacity, or other settings.

## Operation during SD memory card replacement

Mounting the replaced SD memory card on the CPU module causes a "LOGGING" folder to be created. When becoming ready for running the logging function, the CPU module resumes the data transfer into the SD memory card.

The CPU module operates differently as follows depending on the folder configuration in the replaced SD memory card.

Folder constitution	Operation of after SD memory card replacement
The folder not exist.	LOGGING folder is made.
Only LOGGING folder	<ul style="list-style-type: none"> <li>LOGGING folder is renamed by LOGGING_OLD.</li> <li>LOGGING folder is made.</li> </ul>
Only LOGGING_OLD folder	LOGGING folder is made.
LOGGING folder LOGGING_OLD folder	Data logging state changes to error state.

## Precautions

If the internal buffer becomes full during the time between SD memory card replacement and the resumption of data writes to the SD memory card, processing overflow occurs resulting in missing data.

### Storage file numbers after SD memory card replacement

The numbering of the first storage file created after SD memory card replacement differs depending on the storage file switching condition, as described in the following table.

Storage file switching condition	Storage file numbers after SD memory card replacement
Overwrite	Numbering continues from the number of the last storage file contained in the replaced SD memory card.
Stop	Numbering begins at 00000001.*1

\*1 While the data logging file transfer function is used, numbering begins at 00000001 only when the "Delete files completed transfer" is disabled in the "File transfer" of CPU Module Logging Configuration Tool.

#### Point

If the new SD memory card contains a "LOGGING" and "LOGGING\_OLD" folder, data logging cannot be executed. Ensure that the new SD memory card does not contain a "LOGGING" and "LOGGING\_OLD" folder.

### Logging state during SD memory card replacement

SD memory cards can be replaced without depending on the current data logging state.

### Operations during SD memory card replacement

If one of the following operations is performed during the time between the removal and installation of SD memory cards, any data collected during that time will not be stored in the new SD memory card.

- Stop and run\*1
- Power off and on\*1
- Reset\*1
- Suspend data logging
- Stop data logging

\*1 An error is generated if data logging was previously running based on the setting file contained in the replaced SD memory card.

### Operations after SD memory card replacement

If the SD memory card was replaced while data logging was running based on the data logging setting file contained in the SD memory card, the data logging setting file contained in the new SD memory card is used when data logging is started next. If the new SD memory card does not contain the data logging setting file, data logging is not started.

### Stack file remaining in the replaced SD memory card

Replacing an SD memory card that contains a stack file may result in the stack file remaining in the replaced SD memory card along with storage files. If the stack file is remaining in the replaced SD memory card, recover the latest data contained in the stack file by doing the following:

- Retrieve the data from the stack file and combine the data with a storage file.
- Save the stack file as a storage file.

# 21 MEMORY DUMP FUNCTION

This function stores device values of the CPU module at any given timing. Checking data at the desired timing through the function facilitates the analysis of problems which occur depending on a particular condition.

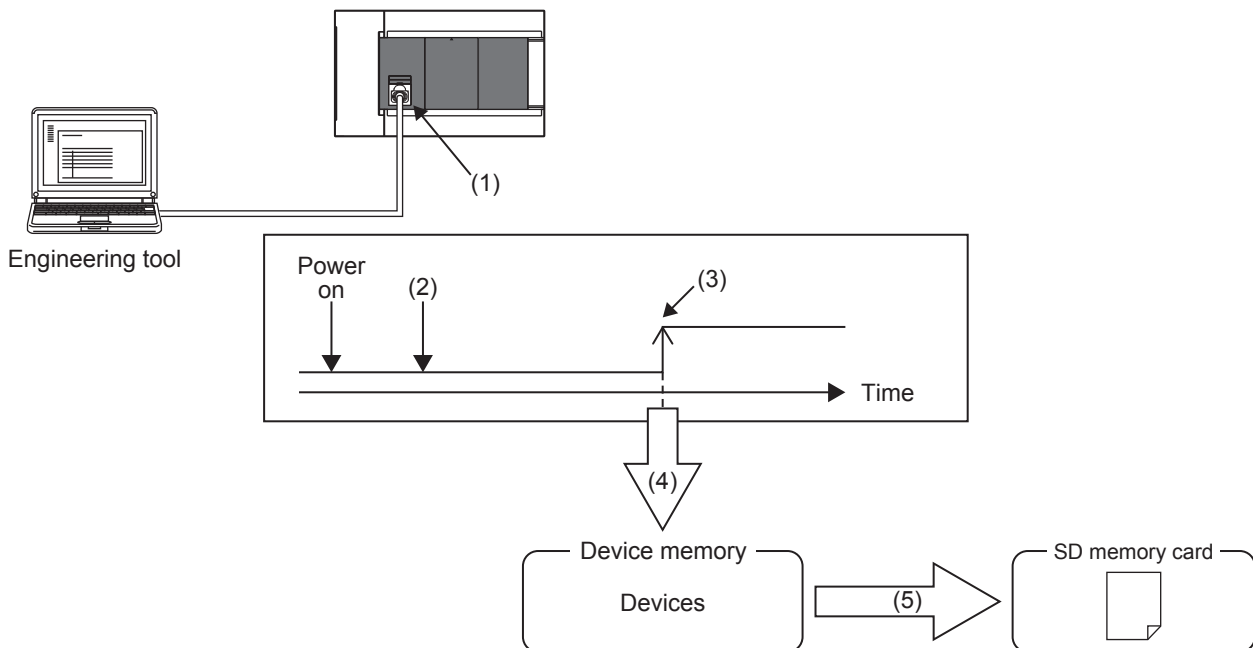

- (1) Perform memory dump settings.
- (2) Enters a wait state for the trigger after the memory dump setting file has been written.
- (3) Establishment of the trigger condition
- (4) Start of data collection
- (5) The memory dump file is stored in the SD memory card. (☞ Page 202 Memory Dump File)

## Point

For supported version of memory dump function, refer to ☞ Page 966 Added and Enhanced Functions.

## Restriction

- This function can be used only when the internal buffer usage function is set to "memory dump function". (☞ Page 206 INTERNAL BUFFER CAPACITY SETTING)
- Memory dump can be performed only between the same models. (FX5U CPU module and FX5UC CPU module are treated as the same models.)

# 21.1 Object Data

This section describes the data to be collected by memory dump.

## Data to be collected

Of the devices listed below, all devices that are within the range specified in the device settings are subject to the collection.

Type	Device
Bit device	X, Y, M, L, B, F, SB, T (contact), T (coil), ST (contact), ST (coil), C (contact), C (coil), LC (contact), LC (coil), S, SM, BL□\S□
Word device	T (current value), ST (current value), C (current value), D, W, SW, SD, R, Z
Double-word device	LC (current value), LZ

### Point

For BL□\S□ (step relay with block specification), data collection is performed only when the SFC program exists. ( MELSEC iQ-F FX5 Programming Manual (Program Design))

# 21.2 Trigger Condition

The following table lists the conditions to be used as a trigger. Set the trigger condition in the memory dump settings. ( IGX Works3 Operating Manual)

Trigger condition	Description
Device specification	Data are collected when the specified monitoring target data (bit data) turns on during the END processing.
At the occurrence of an error	Data is collected using the SM0 (latest self-diagnosis error) OFF→ON as the trigger.

## Precautions

On the occurrence of consecutive triggers, if the status of data save due to the previous occurrence of trigger is "Save complete" of collected data, the next trigger is recognized as a trigger again. Note that events other than the above are not recognized as a trigger condition.

### Point

A trigger can be generated with trigger conditions combined. ( Page 200 Combining trigger conditions)



# Device specification

Data are collected when the specified monitoring target data turns on during the END processing.

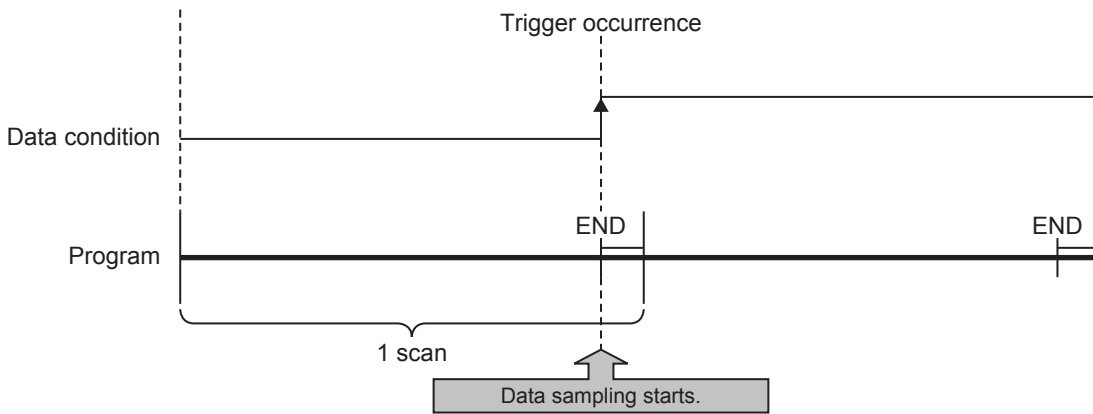

For monitoring data, the following devices can be specified.

Type	Device <sup>*1</sup>
Bit device	X, Y, M, L, F, SM, B, SB, T (contact) <sup>*2</sup> , ST (contact) <sup>*2</sup> , C (contact) <sup>*2</sup> , LC (contact) <sup>*2</sup>

\*1 Index modification, and indirect specification cannot be specified.

\*2 To specify these devices with the engineering tool, use T (contact): TS, ST (contact): STS, C (contact): CS, and LC (contact): LCS.

## Precautions

Even though the value of the monitoring target data changes during a single scan, if the value during the END processing is same as that during the last END processing, it is not recognized as a trigger.

## At the occurrence of an error

Data is collected using the SM0 (latest self-diagnosis error) OFF→ON as the trigger.

The trigger occurs at the END process of the scan in which the error occurred.

## At the occurrence of a continuation error

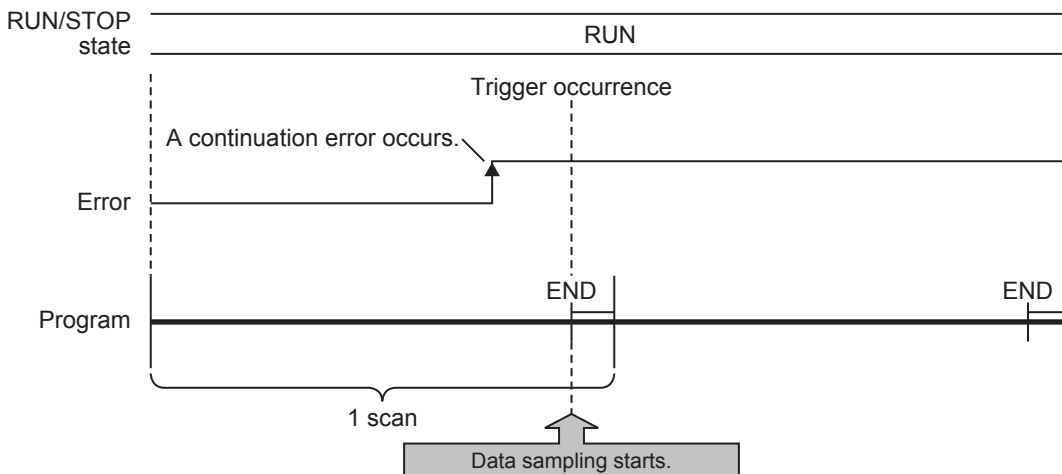

## Precautions

If the same continuous error occurs after SM0 turns ON, it will not be recognized as a trigger, so data will not be collected. Being recognized as a trigger requires the error to be cleared.

## At the occurrence of a stop error

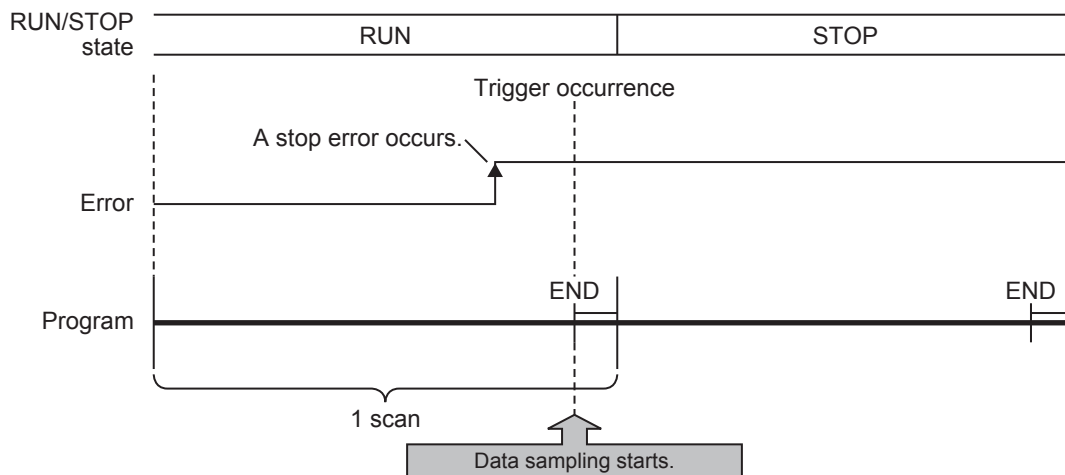

### Point

Even if an error occurs, if the function (analog function, etc.) does not cause SM0 to turn ON, memory dump using SM0 as the trigger cannot be executed. By specifying a device for each function's error display with the device specification, memory dump can be executed even when an error occurs in a function that does not cause SM0 to turn ON.

## Combining trigger conditions

A trigger can be generated with trigger conditions combined. This combination is based on an OR condition. The establishment of a condition, either device specification or error code specification, results in data collection.

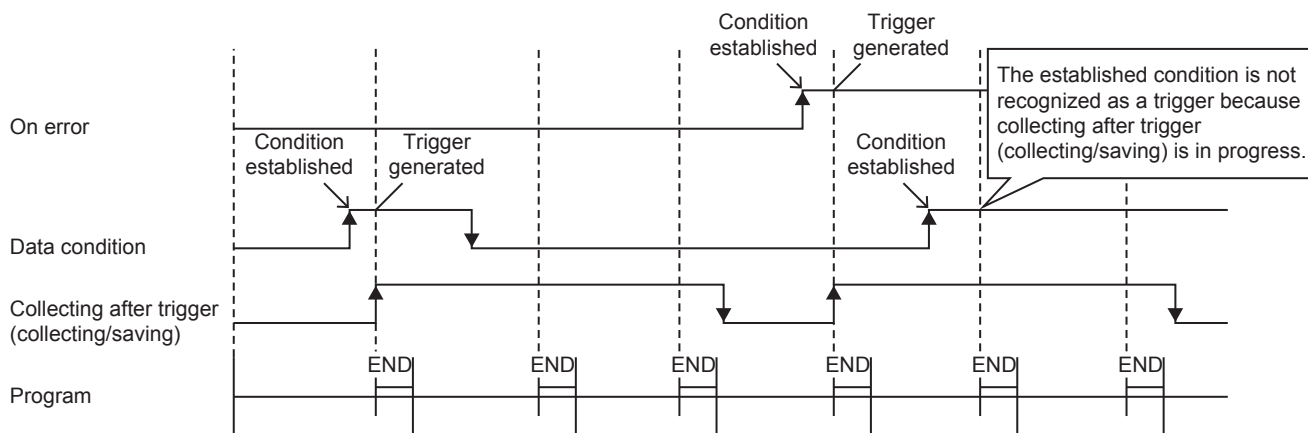

### Precautions

If the trigger conditions are established again during data collection, the state will not be recognized as a trigger so data will not be collected.

### Point

If the trigger conditions for both device specification and error occurrence are established within the same scan, the trigger conditions for error occurrence will have priority.

## 21.3 Procedure for Memory Dump

This section describes the procedure for memory dump. Note that each operation of the memory dump function is performed with the engineering tool.

 [Debug] ⇄ [Memory Dump]

For how to view and operate the window, refer to the following.

 GX Works3 Operating Manual

1. Configure the memory dump settings by the menu operation in the engineering tool.
2. Writing the memory dump setting file results in a wait state for the trigger. Whether the CPU module is in a RUN state, STOP state (including stop error<sup>\*1</sup>), or PAUSE state, a wait state for the trigger results.

\*1 Limited to where the trigger condition is device specification.

### Point

- If the memory dump setting file is stored, the memory dump will be executed when the CPU module power is turned OFF→ON or reset.
- The engineering tool allows the memory dump status to be checked.

3. Establishment of the trigger condition initiates data collection, saving the memory dump file to the SD memory card.
4. The contents of the memory dump file (collected device data) can be checked with the engineering tool.

## 21.4 Flow of Data Collection

Collected data is stored in the internal buffer, where the data is partitioned at END processing and saved in the SD memory card. When a trigger is generated, the END process will take longer than usual.

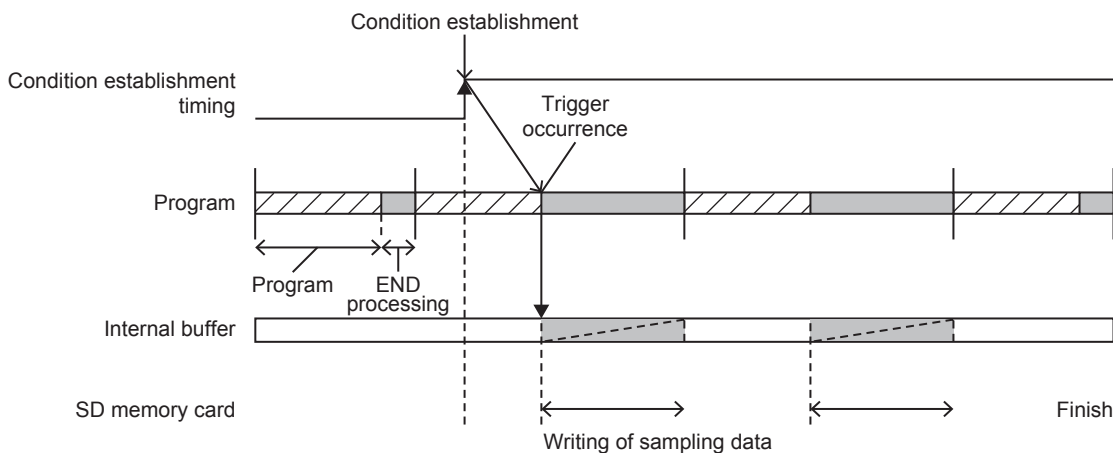

### Precautions

- If a user interrupt occurs while transferring the device data to the internal buffer, a data inconsistency will occur.
- If a user interrupt occurs while transferring double-word devices, an inconsistency will occur in the high-order and low-order word devices.

### Effect on the scan time

If the memory dump function detects a trigger, the scan time will increase as follows when collecting the data.

- FX5UJ CPU module: Approx. 25ms
- FX5U/FX5UC CPU module: Approx. 15ms (Approx. 16ms if SFC program exists)

# 21.5 Memory Dump File

This file stores data that is collected through memory dump (collection result by memory dump). Data collected by one execution is saved in one file. The memory dump file is saved in a binary format and stored under the "MEMDUMP" folder.

## Save file name

The file name can be arbitrarily set within a range of 64 characters (extension and period included) together with an auto-assigned number (00 to 99). Specify the save file name in the memory dump settings. (GX Works3 Operating Manual)

**Ex.**  
MEMDUMP\_00\*1

- \*1 Between a specified file name (MEMDUMP) and an auto-assigned number (00), the single-byte underbar ( \_ ) is added. If a file name with 5 or less characters is specified, the lowercase characters used in the file name may be handled as uppercase characters.

When the memory dump function is registered, the debug folder (DEBUG (fixed)) and the memory dump folder (MEMDUMP (fixed)) are created in the SD memory card. The memory dump file (result file) is stored in the memory dump folder. One folder can contain a maximum of 100 files. If any file does not exist in creating a save file, the file with the number 00 is created. If any file already exists in creating a save file, the behavior is as follows:

Number of files	Behavior
For less than 100	Creates a file*2 assigning the number obtained by adding 1 to the number of the file where the creation date and time is the latest.
For 100 (maximum)	Deletes the file where the creation date and time is the oldest and creates a new file using the deleted number as it is.

- \*2 If the corresponding file number is 99, a file with file number 00 is created.

# 21.6 States of the Memory Dump Function

The state of the memory dump function is reflected in the memory dump status. The engineering tool allows the memory dump status to be checked. (GX Works3 Operating Manual)

## Memory dump status

The following table lists the memory dump status.

Memory dump status	Description
Stop	State in which memory dump is not registered
Trigger-wait not collected	A state in which data is not yet collected and establishment of the trigger condition is being waited
Collecting after trigger	A state in which collection of the data after trigger is in progress (includes a state in which collected data is being saved in the target memory)
Collection completed	A state in which collection of a specified data is completed
Error	A state in which a memory dump error occurs and memory dump fails

# 21.7 Sizes of Files Used for the Memory Dump Function

This section shows the sizes of files used for the memory dump function.

## Capacity of the memory dump setting file

The capacity of the memory dump setting file varies depending on the length of the save file name. The following formula is used for the calculation:

- Capacity of memory dump setting file =  $((\text{Number of characters of save file name}^{*1} \times 2 \text{ bytes} + 1201 \text{ bytes (fixed)}) + 3) \div 4$   
 $^{*2} \times 4$

\*1 Except for the period and extension.

\*2 The remainder is discarded.

## Capacity of the memory dump file

The capacity of the memory dump file is given by the total of the following items:

- Capacity of memory dump file = Volume of header + Volume of data of program file name<sup>\*1</sup> + Volume of device data + Volume of local device data<sup>\*1</sup>

\*1 Only when BL□\S□ (step relay with block specification) is collected.

### Volume of header

The volume of header is given by:

- Volume of header = 1088 bytes (fixed)

### Volume of data of program file name

Volume of data of program file name is given by the total of the following items. Only when BL□\S□ (step relay with block specification) is collected, this data is created in the memory dump file.

- Volume of data of program file name = 16 bytes (fixed) + (Number of programs  $\times$  (2 bytes (length of program file name) + 130 bytes (program file name)))

### Volume of device data

The volume of device data is given by the total of the following items. Note that this data is always created in the memory dump file regardless of the settings of CPU parameters.

- Volume of device data = 520 bytes (fixed) + Volume of collected device data

#### ■Volume of collected device data

[FX5S/FX5U/FX5UC CPU modules]

The volume of collected device data is given by the following:

- Volume of collected device data = (Total number of points of bit devices  $\div$  8) + (Total number of points of word devices  $\times$  2) + (Total number of points of word devices  $\times$  4)

[FX5UJ CPU module]

The volume of collected device data is 116702 bytes (fixed).

### Volume of local device data

The volume of local device data is given by the total of the following items. Only when BL□\S□ (step relay with block specification) is collected, this data is created in the memory dump file.

- Volume of local device data = 16 bytes (fixed) + (Number of programs  $\times$  4 bytes) + Volume of local device contents
- Volume of local device contents = 580 bytes (fixed) + Volume of collected local device data<sup>\*1</sup>

\*1 The total of volume which is given by calculating the number of points of S (step relay) which is assigned to each block of BL0 to BL31 of the SFC program by the following volume of block data.

Volume of block data =  $((\text{the number of points of S (step relay) which is assigned to block} + 15) \div 16) \times 2$

## 21.8 Special Relay and Special Register Used in the Memory Dump Function

For details on the special relay and special register used in the memory dump function, refer to the following:

- Special relay: Special relay relating to the memory dump function (☞ Page 778 Memory dump function)
- Special register: Special register relating to the memory dump function (☞ Page 810 Memory dump function)

## 21.9 Precautions for the Memory Dump Function

This section describes precautions to take when using the memory dump function

### Mutual exclusion of the memory dump function

The mutual exclusion of the memory dump function is as follows.

#### ■When another function is executed

The following table lists the cases when another function is executed during the execution of the memory dump function\*<sup>1</sup>.

Function that has been already executed	Function to be executed later	Operation
Memory dump function	Data logging function	The memory dump function and data logging function cannot be used simultaneously.
	Data backup function	The data backup function cannot be executed while memory dump is being registered/cleared.
	Data restoration function	The data restoration function cannot be executed while a memory dump file or memory dump setting file is being read or memory dump is being registered/cleared.

\*<sup>1</sup> Indicates the state in which the memory dump status is "Collecting after trigger" or the save status is "Saving in progress".

#### ■When the memory dump function is executed during the execution of another function

The following table lists the cases when the memory dump function is executed during the execution of another function.

Function that has been already executed	Function to be executed later	Operation
Data logging function	Memory dump function	The memory dump function and data logging function cannot be used simultaneously.
Data backup function		While the data backup function is being executed, memory dump cannot be registered/cleared.
Data restoration function		While the data restoration function is being executed, a memory dump file or memory dump setting file cannot be read or memory dump cannot be registered/cleared.

#### ■When the memory dump function is executed

The following table shows the cases where the file operation related to the memory dump function is executed while the memory dump function is in execution.\*<sup>1</sup>

Target file	File operation	Operation
Memory dump setting file	Write	Settings that are subsequently written during the execution of the memory dump function are reflected after the completion of save, not reflected immediately.
	Delete	If the memory dump setting file is subsequently deleted during the execution of the memory dump function, the memory dump settings are cleared after the completion of save.
	Initialize	Initialization fails on the memory dump setting file during the execution of the memory dump function.
Memory dump file	Write, read, delete, and initialize	Write, read, delete, and initialize on the memory dump file cannot be performed during the execution of the memory dump function.

\*<sup>1</sup> Indicates the state in which the memory dump status is "Collecting after trigger" or the save status is "Saving in progress".

## Operation on each individual file

Write, read, delete, and initialize are possible on each file. The following table shows whether each operation is possible or not depending on the execution status of memory dump.

○: Operation possible, ×: Operation not possible

File type	Operation to be performed					
	Read		Write/delete		Initialize	
	Not during execution <sup>*1</sup>	During execution <sup>*1</sup>	Not during execution <sup>*1</sup>	During execution <sup>*1</sup>	Not during execution <sup>*1</sup>	During execution <sup>*1</sup>
Memory dump setting file	○	○	○	○	○ <sup>*2</sup>	×
Memory dump file	○	×	○	×	○	×

\*1 Indicates the state in which the memory dump status is "Collecting after trigger".

\*2 The memory dump function is canceled when the memory dump setting file is initialized (when data memory is initialized).

## Where to carry out memory dump

Concurrent execution from multiple sources is not allowed. In the CPU module, execution at a time from only one source is possible.

## Creating files and folders

Under the "MEMDUMP" folder containing memory dump files, do not create any files or folders using a personal computer or other device. Doing so may result in deletion of files and folders.

## Access to the SD memory card

The SD memory card is so frequently accessed that a delay occurs in completing the access to the SD memory card (read/write).

## Operation when creating memory dump file

Do not turn the CPU module power OFF, reset, or eject the SD memory card while creating the memory dump file. An error such as failure to create file or failure to read created file may occur.

## Simultaneous execution with the file transfer function (FTP client)

Do not transfer the file during writing with the memory dump function by the SP.FTPPUT/SP.FTPGET instruction.

## Event history function

If the memory dump trigger conditions are established when saving the event information in the SD memory card by generating an event with the event history function, only data collection will be executed with the memory dump function. Transfer to the SD memory card will be executed when the event history function has completed file access. In the same manner, if an event is generated with the event history function that saves during memory dump execution, the event history function data will be transferred to the SD memory card after memory dump transfer to the SD memory card is completed.

# 22 INTERNAL BUFFER CAPACITY SETTING

Configure the capacity of an area (internal buffer) that the system consumes to temporarily store the result of data logging and the collection result of memory dump. When using the data logging function, adjusting the internal buffer capacity allows an increase in the number of collected data and reduces the risk of processing overflow.

Navigation window ⇒ [Parameter] ⇒ [Module model name] ⇒ [CPU Parameter] ⇒ "Memory/Device Setting" ⇒ "Internal Buffer Capacity Setting"

## Window

Item	Setting
<b>Internal Buffer Capacity Setting</b>	
Total Capacity	320 K Byte
Function to Use Internal Buffer	Data Logging Function
Data Logging Function	
Total Capacity	320 K Byte
Setting No.1	80 K Byte
Setting No.2	80 K Byte
Setting No.3	80 K Byte
Setting No.4	80 K Byte
Memory Dump Function	0 K Byte

## Displayed items

Item	Description	Setting range	Default
Total Capacity	Shows the total of the internal buffer capacity set in the data logging function or the memory dump function.	<ul style="list-style-type: none"> <li>■FX5S/FX5UJ CPU module               <ul style="list-style-type: none"> <li>• 320K bytes (fixed)</li> </ul> </li> <li>■FX5U/FX5UC CPU module               <ul style="list-style-type: none"> <li>• 0 to 320K bytes</li> </ul> </li> </ul>	320K bytes
Function to Use Internal Buffer	Set the function to use the internal buffer.	<ul style="list-style-type: none"> <li>• Data Logging Function</li> <li>• Memory Dump Function</li> </ul>	Data Logging Function
Data Logging Function	Total Capacity	—	320K bytes
	Setting No.1 to 4	<ul style="list-style-type: none"> <li>■FX5S/FX5UJ CPU module               <ul style="list-style-type: none"> <li>• Each setting range: 80K bytes (fixed)</li> <li>• Total setting range: 320K bytes (fixed)</li> </ul> </li> <li>■FX5U/FX5UC CPU module               <ul style="list-style-type: none"> <li>• Each setting range: 32 to 320K bytes (in increments of 1K bytes)<sup>*1</sup></li> <li>• Total setting range: 32 to 320K bytes</li> </ul> </li> </ul>	80K bytes
Memory Dump Function	Set the internal buffer capacity used for the memory dump function.	192K bytes (fixed) <sup>*2</sup>	192K bytes

\*1 0K byte (fixed) when using memory dump function.

\*2 0K byte (fixed) when using data logging function.

### Point

The internal buffer is also consumed by the real-time monitor function. The internal buffer capacity consumed by the real-time monitor function is 64K byte (fixed).

### Restriction

For supported version of FX5U/FX5UC CPU module internal buffer capacity setting, refer to  Page 966 Added and Enhanced Functions.





# 23 DATA BACKUP/RESTORATION FUNCTION

This function backs up the data memory and device/label data<sup>\*1</sup> and the SFC program execution status<sup>\*2</sup> of a CPU module to an SD memory card. The data backed up in the SD memory card can be restored as required.

\*1 Module access devices and buffer memory are excluded.

\*2 Only the FX5U/FX5UC CPU modules are supported.

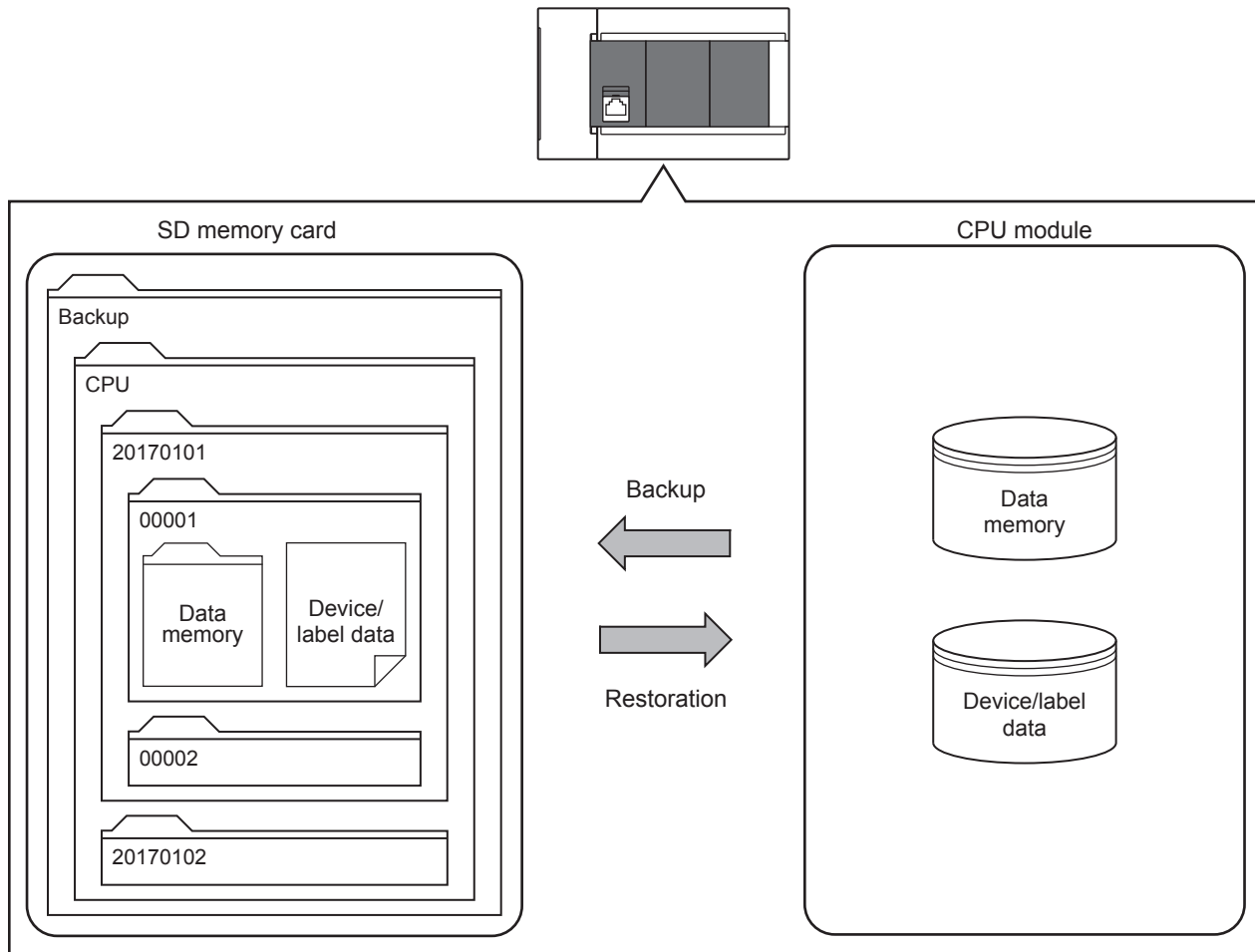

The following table lists the methods of the data backup/restoration.

Function		Reference
Backup function	Backup processing triggered by turning on SM1351 (Normal mode)	Page 213
	Backup processing triggered by turning on SM1351 (CPU module auto exchange function)	Page 214
Restoration function	Restoration processing triggered by turning on SM1354	Page 219
	Automatic restoration using SD955	Page 220
	Restoration triggered by CPU module auto exchange	Page 221

## Point

- For supported version of FX5U/FX5UC CPU module data backup/restoration function, refer to Page 966 Added and Enhanced Functions.
- The CPU module device/label data is changed when restoration is executed. Thus, after restoration, confirm the restored data carefully before using it. (Check the data with GX Works3.)

## Backup data

Backup data is saved in an SD memory card. The following shows the folder structure of backup data.

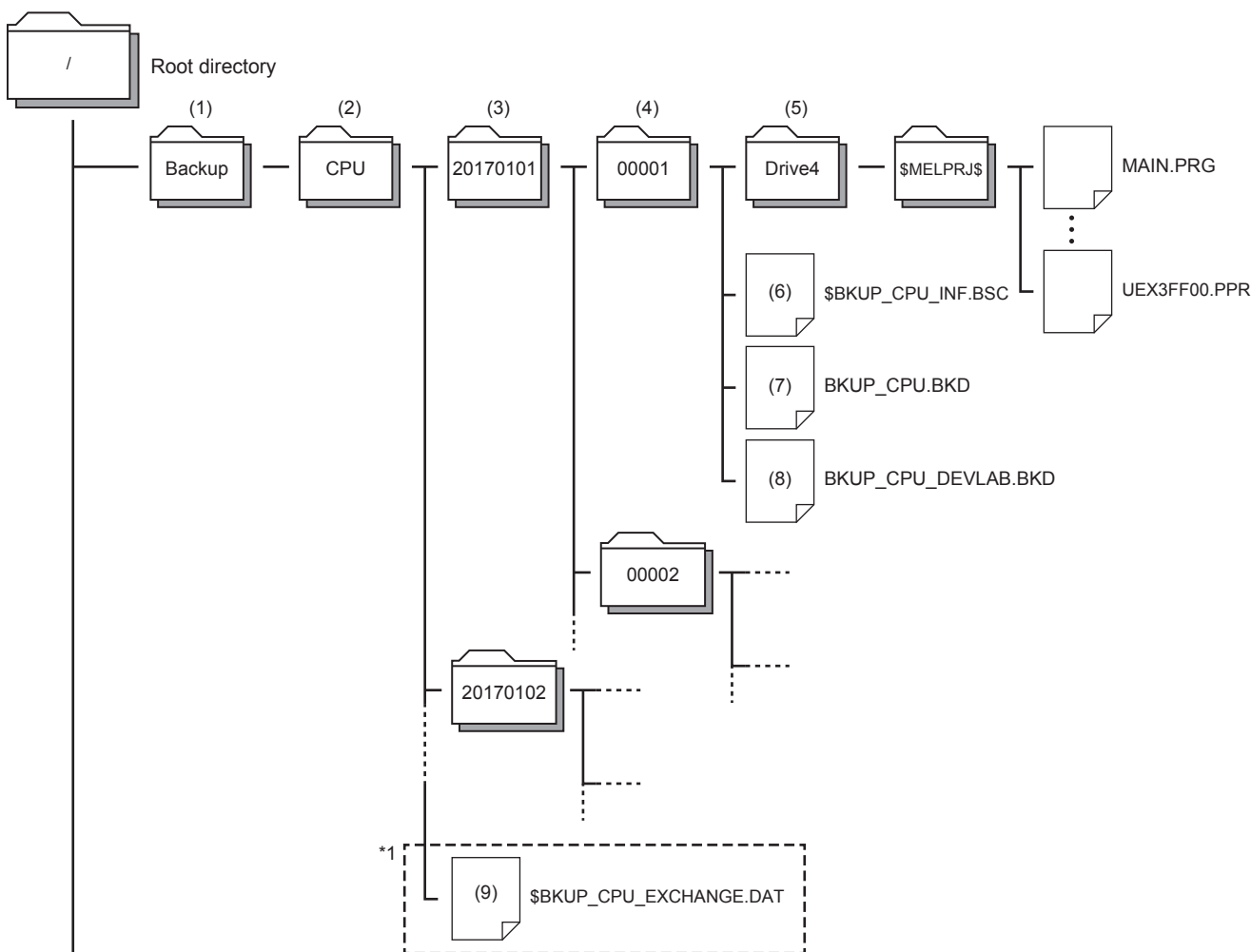

\*1 When backing up by CPU module auto exchange mode (Deleting existing data), if the system file for CPU module auto exchange function is stored in the CPU data folder, only the latest folder will exist for the date folder and number folder.

### Folder

No.	Folder type	Folder name	Number of storable folders	Description
(1)	Backup data folder	Backup (Fixed)	1	A folder for storing all backup data
(2)	CPU data folder	CPU (Fixed)	1	A folder for storing backup data of the CPU module
(3)	Date folder	Automatically determined* <sup>1</sup> Folder name format: YYYYMMDD • YYYY: Year when the data was backed up (four digits) • MM: Month when the data was backed up (two digits) • DD: Day when the data was backed up (two digits)	Depends on the capacity of the SD memory card used* <sup>2</sup>	Folders for storing backup data by date
(4)	Number folder	Automatically determined* <sup>1</sup> Folder name: Sequentially numbered from 00001 to 32767 (five digits)	Depends on the capacity of the SD memory card used* <sup>2</sup>	Folders for storing information per backup data. Each backup data created on a date is stored in sequentially numbered folders.
(5)	Drive folder	Drive4 (Fixed)	One in each Number folder	Folders for storing folders/files stored in each drive of the backup target CPU module, separated by drive

\*1 Date folders and number folders are automatically named by the CPU module.

\*2 The maximum number of storable folders is 32767. However, when backing up with the CPU module auto exchange mode (Deleting existing data), the folders other than the latest folder will be deleted.

## ■ Back up file

No.	File type	File name	Description
(6)	System file for backing up CPU module data	\$BKUP_CPU_INF.BSC	Files for storing the information required at restoration of data, such as a list of backup data and identification information of the CPU module.
(7)	Backup data file for backing up CPU module data	BKUP_CPU.BKD	The following data is stored. <ul style="list-style-type: none"> <li>• Data on operations of the data logging setting</li> <li>• Data for restarting the SFC program from the block and step where the processing was stopped</li> </ul>
(8)	Device/label data file for backing up CPU module data	BKUP_CPU_DEVLAB.BKD	Device/label data is stored.
(9)	System file for CPU module auto exchange function	\$BKUP_CPU_EXCHANGE.DAT	Information required for restoration with the CPU module auto exchange, such as restoration target directory path name, etc., is stored.

## Backup/restoration target data

Backup target data is all target data in the CPU module. (☞ Page 210 Backup/restoration target files)

Restoration target data is set with SD954 (Restoration target data setting). (☞ Page 217 Restoration target data)

## ■ Backup/restoration target drives

Target drives is Drive4 (Data memory).

## ■ Backup/restoration target files

The following table lists backup/restoration target files.

○: Available, ×: Not available

File type	Backup/restoration
Program	○
FB files	○
CPU parameters	○
System parameters	○
Module parameters	○
Module extension parameter	○
Memory card parameter	×
Device comments	○
Device initial values	○
Event history	○
Global label settings	○
Device data storage file	○
Data logging setting file	○
Memory dump setting file	○
Remote password	○
Firmware update	×
Firmware update prohibited	○
Extended file register file	×
Device station parameter file*1	○
Web server binary file	×
General-purpose data	×

\*1 Applicable only to FX5U/FX5UC CPU module.

## ■ The number of CPU module backup data that can be stored in an SD memory card

The number of CPU module backup data that can be stored in an SD memory card is 32767.

The number of files that can be backed up and restored (the number of backup source data files) depends on the maximum number of files of the drive. (☞ Page 46 CPU MODULE MEMORY CONFIGURATION)

## ■Backup/restoration target device data

○: Available, ×: Not available

Classification	Device name	Symbol	Backup/restoration possibility <sup>*1</sup>	
			Backup	Restoration
User device	Input	X	○	○
	Output	Y	×	×
	Internal relay	M	○	○
	Latch relay	L	○	○
	Link relay	B	○	○
	Annunciator	F	○	○
	Link special relay	SB	○	○
	Step relay	S	○	○
	Timer	T	○	○
	Retentive timer	ST	○	○
	Counter	C	○	○
	Long counter	LC	○	○
	Data register	D	○	○
	Link register	W	○	○
	Link special register	SW	○	○
System device	Special relay	SM	○	○ <sup>*2</sup>
	Special register	SD	○	○ <sup>*2</sup>
Module access device (U□\G□)	Module access device	G	×	×
Index register	Index register	Z	○	○
	Long index register	LZ	○	○
File register	File register	R	○	○
	Extended file register	ER	×	×
Nesting	Nesting	N	×	×
Pointer	Pointer	P	×	×
	Interrupt pointer	I	×	×
SFC <sup>*3</sup>	SFC block device	BL	×	×
	SFC transition device	TR	×	×
Constant	Decimal constant	K	×	×
	Hexadecimal constant	H	×	×
	Real constant	E	×	×
	Character string constant	—	×	×

\*1 Device data may be overwritten depending on the mounting status (I/O refresh) of each module or the refresh settings.

\*2 Values may be overwritten to the areas used by the system after the restoration processing.

Restoring or not restoring can be selected with either of SD955 (restoration function setting) or SD9352 (CPU module auto exchange function setting).

\*3 Only FX5U/FX5UC CPU module is supported.

## ■Backup/restoration target label data

○: Available, ×: Not available

Classification	Backup/restoration possibility <sup>*1</sup>	
	Backup	Restoration
Global label (including module labels)	○	○ <sup>*2</sup>
Global label with latch specified	○	○
Local label	○	○
Local label with latch specified	○	○

\*1 Device data may be overwritten depending on the mounting status (I/O refresh) of each module or the refresh settings.

\*2 For module labels, the write areas from a module to the CPU module may be overwritten when the refresh settings have been made.

## Progress of the backup/restoration processing

The progress of the backup/restoration processing can be checked with SD1350 (Number of uncompleted folders/files of CPU module data backup/restoration) or SD1351 (Progression status of CPU module data backup/restoration).

Special register	Description
SD1350	Displays the number of remaining backup/restoration target folders and files. <ul style="list-style-type: none"><li>• When the backup/restoration processing is started, the total number of backup/restoration folders and files is stored.</li><li>• When the backup/restoration processing is completed, 0 is stored.</li></ul>
SD1351	Displays the progress of the backup/restoration processing in percentage (0 to 100%). However, the progress of automatic restoration using SD955 and restoration with CPU module auto exchange are displayed only when the restoration finishes correctly (100%).

# 23.1 Backup Function

This function backs up the CPU module data memory and device/label data onto the SD memory card. A new folder is created during the backup, and the data is backed up with a file format into that folder.

### Point

The backup function operates even when the CPU module is in the RUN state.

When executing the backup function with the CPU module in the RUN state, do not change device/label data during execution of the function. Doing so may cause data inconsistency of the device/label data and the contents of the backup data may unintentionally change.

## Operation mode

Backup modes include the normal mode and CPU module auto exchange mode. The operation mode is set with SD9350 (Operation mode setting).

Value of SD9350	Operation mode	Reference
0	Normal mode	Page 213
1	CPU module auto exchange function (Deleting existing data)	Page 214
2	CPU module auto exchange function (Holding existing data)	

## Restoration target data setting

When backing up (CPU module auto exchange mode) by turning SM1351 ON, the data targeted for restoration with CPU module auto exchange is set. Set with SD9351 (CPU module automatic replacement function Restore target data setting).

Value of SD9351	Restoration target data setting
0	Only device/label data
1	All target data
2	All target data excluding device/label data

The settings are reflected onto the system file for CPU module auto exchange function.

## Restoration of the special relay and special register

Set whether or not to restore the special relays and special registers with the CPU module auto exchange when backing up with SM1351 ON (CPU module auto exchange mode). Set with SD9352 (CPU module auto exchange function setting) b14 (special relay, special register restoration (CPU module auto exchange function)).

b14 of SD9352	Restoration target data setting
OFF	The special relay and special register are not restored.
ON	The special relay and special register are restored.

The settings are reflected onto the system file for CPU module auto exchange function.

## Initializing target data

When backing up with SM1351 ON (CPU module auto exchange mode), set whether or not to initialize the drive other than the SD memory card at the time of restoration by the CPU module auto exchange. Set with SD9352 (CPU module auto exchange function setting) b1 (initialize during CPU module auto exchange function).

This setting is valid only when the SD9351 (CPU module automatic replacement function Restore target data setting) value is 1 (restoration target data is all target data).

b1 of SD9352	Restoration target data setting
OFF	Do not initialize.
ON	Initialize.

The settings are reflected onto the system file for CPU module auto exchange function.

## Setting of operation after restoration

When using backup processing triggered by turning on SM1351 (CPU module auto exchange mode), after restoration is executed with CPU module auto exchange, the CPU module operation can be continued from the backed up state or from the initialized state. This can be set with SD9352 (CPU module auto exchange function setting) b15 (setting of operation after CPU module auto exchange function). The operation of each item using the operation setting after restoration is shown below.

Item	Setting of operation after restoration by CPU module auto exchange	
	Continue operation from backed up state (b15 of SD9352 = ON)	Operate from initialized state (b15 of SD9352 = OFF)
Initial device value	Do not set device initial values after restoration.	Set device initial values after restoration. (Device data from backed up state is overwritten with device initial values.)
SFC program	When "Resume Start" was selected before data backup, the SFC program is resumed after restoration processing.*1	The SFC program is not resumed after restoration processing even though "Resume Start" was selected before data restoration.
Event history	Set event history during backup.	Do not set backup event history, and create new file.

\*1 When a battery is not mounted, the start of the SFC program is initial start regardless of setting of operation after restoration. The settings are reflected onto the system file for CPU module auto exchange function.

Note that this setting is invalid since the device initial value file, SFC program, and event history file are not restored when the value in SD9351 (CPU module automatic replacement function Restore target data setting) is 0 (restoration target data are only device/label data).

## Backup processing triggered by turning on SM1351 (Normal mode)

Data in the CPU module is backed up at a desired timing. Each time backup is requested, the year, date and serial No. of the date folder and number folder are updated (newly created), and the following backup data is created.

- System file for backing up CPU module data
- Backup data file for backing up CPU module data
- Device/label data file for backing up CPU module data

## Operating procedure

1. Set 0 (Normal mode) for SD9350 (Operation mode setting).
2. Turn on SM1351 (Data backup execution request).

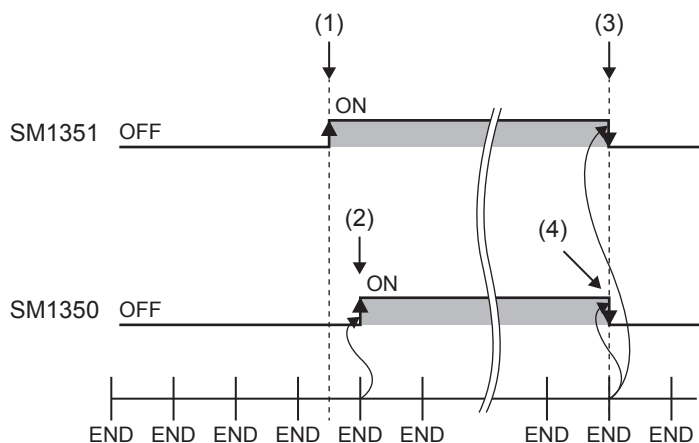

- (1) Turn on SM1351.
- (2) The system turns on SM1350 (Data backup status flag).
- (3) The system turns off SM1351 after the backup processing is completed.
- (4) The system turns off SM1350.

If the backup processing is completed with an error and SM953 (Data backup error check flag) turns on, check SD953 (Backup error cause), take actions, and then back up the data again as required.

### Point

- The execution status of the backup processing can be checked with SD1350 (Number of uncompleted folders/files of CPU module data backup/restoration) and SD1351 (Progression status of CPU module data backup/restoration). (Page 212 Progress of the backup/restoration processing)
- If the system file for the CPU module auto exchange function is stored in the CPU data folder, the system file for the CPU module auto exchange function will be deleted when the backup execution request (SM1351) changes from OFF to ON.

## Backup processing triggered by turning on SM1351 (CPU module auto exchange function)

Data in the CPU module is backed up at a desired timing. The operation during back up differs according to the SD9350 (operation mode setting) value.

### Operation mode

#### ■ CPU module auto exchange mode (Deleting existing data)

When the SD9350 value is 1, each time the backup is requested, all of the data under the CPU data folder in the SD memory card is deleted, and a date folder, number folder, and the backup data are created. (Only the latest backup file is stored on the SD memory card.)

#### ■ CPU module auto exchange mode (Holding existing data)

When the SD9350 value is 2, each time the backup is requested, the year, date, and serial No. of the date folder and number folder are updated (newly created), and the backup data is created. (Multiple backup folders are stored on the SD memory card.)

The backup files created during the backup processing triggered by turning on SM1351 (CPU module auto exchange mode) are shown below.

- System file for backing up CPU module data
- Backup data file for backing up CPU module data
- Device/label data file for backing up CPU module data
- System file for CPU module auto exchange function



## Operating procedure

1. SM9350 (CPU module auto exchange function enable/disable flag) is turned OFF (enable).
2. Set SD9350 (Operation mode setting) to 1 or 2\*<sup>1</sup>.
3. With SD9351 (CPU module automatic replacement function Restore target data setting), set the data to be restored when executing restoration with CPU module auto exchange.\*<sup>2</sup>
4. Make each setting with SD9352 (CPU module auto exchange function setting) b1\*<sup>2</sup>, 14, and 15\*<sup>2</sup>.
5. Turn on SM1351 (Data backup execution request).

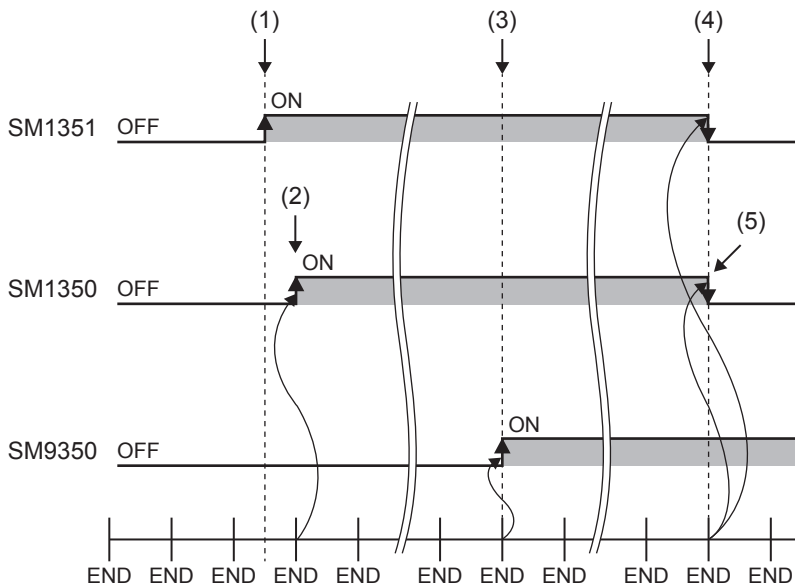

- (1) Turn on SM1351.
- (2) The system turns on SM1350 (Data backup status flag).
- (3) System file for CPU module auto exchange function is created, and the system turns SM9350 (CPU module auto exchange function enable/disable flag) ON (disable).
- (4) The system turns off SM1351 after the backup processing is completed.
- (5) The system turns off SM1350.

\*1 Only 1 (CPU module auto exchange mode (delete existing data)) is valid with firmware version of FX5U/FX5UC CPU module earlier than "1.050".

\*2 For the FX5U/FX5UC CPU modules, this operation is required when the firmware version is "1.050" or later.

If the backup processing is completed with an error and SM953 (Data backup error check flag) turns on, check SD953 (Backup error cause), take actions, and then back up the data again as required.

### Point

The execution status of the backup processing can be checked with SD1350 (Number of uncompleted folders/files of CPU module data backup/restoration) and SD1351 (Progression status of CPU module data backup/restoration). (Page 212 Progress of the backup/restoration processing)

## Checking backup errors

When an error has occurred, a diagnostic error is not detected and an error code is stored in SD953 (Backup error cause). (Page 851 List of error codes)

## Precautions

The following describes the precautions for the backup function.

### Prohibited operation during execution of the backup processing

Do not perform the following operations during execution of the backup processing.

- Attaching or detaching the SD memory card
- Powering off or resetting the CPU module

The above mentioned operations leave the backup data in the SD memory card in an incomplete state which is in the middle of the backup processing.

Do not use these data for a restoration. If these data are used, the restoration completes with an error.

## Suspending backup processing

The following operation can suspend a backup processing.

- Setting the SD memory card forced disable

Suspending a backup processing leaves the backup data in the SD memory card in an incomplete state which is in the middle of the backup processing. Do not use these data for a restoration. If these data are used, the restoration completes with an error.

## Device/label data

To execute the backup processing, do not change device/label data during execution of the processing. Since device/label data is divided into multiple scans and backed up, changes in the device/label data may cause data inconsistency.

## Operations and functions that cannot be performed

While the following operations or functions are being executed, the backup processing cannot be executed.

The following operations and functions cannot be executed during execution of the backup processing.

Operation or function		
Operation from GX Works3	Initializing the CPU built-in memory/SD memory card	
	Clearing values (Devices, labels, latches)	
	Reading data from the PLC	
	Writing data to the PLC	
	Verifying data with the PLC	
	Deleting data in the PLC	
	Online change	
	Event history function (Updating event history data, clearing event history)	
	File password function	
	Security key authentication function (Writing/deleting a security key to/in the CPU module)	
	Predefined protocol support function (Writing/reading/verifying protocol setting data)	
	Memory dump function (Memory dump setting/reading results, registering/clearing memory dump)	
Operation using the CPU module logging configuration tool	Data logging function (Writing/reading/deleting a logging setting file, registering/clearing a logging setting)	
	Operation of a logging file (deletion)	
Others	Initial device values (CPU module: STOP → RUN)	
	• SLMP • MC protocol	Remote latch clear
	Ethernet communication	File transfer function (FTP server)
		File transfer function (FTP client)

## Special relay and special register that function as flags to execute other functions

Before executing the backup processing, turn off the special relay and special register that function as flags to execute other functions. If the backup processing is executed when they are on, the corresponding function request may turn on and the function may be executed at the restoration of data in the special relay and special register.

## SFC program status

Do not change the status of the SFC program, such as step active status and transition conditions during execution of the backup processing. If the status of the SFC program was changed, the backup processing is completed with an error.

## Time required for completing the backup processing

It may take time for the backup to finish in the following cases:

- When the size of data or number of folders/files stored on the CPU module is large
- When a function that accesses the SD memory card, such as data logging function or event history function (save destination: SD memory card), is operating
- When Ethernet communication is in progress

If the backup does not finish, format the SD memory card, or re-insert the memory card. If the backup still does not finish, the SD memory card may have a hardware error, so replace the SD memory card.

### Precautions

The scan time increases during backup.

## Backup when changing the parameters

If the CPU module parameters have been changed, power off and on the CPU module or reset the CPU module to apply the parameters. Then execute backup. If backup is executed before the parameter changes are applied, restoration may not be carried out correctly.

## Random folder/file

Do not create a random folder/file in the CPU data folder. The backup will not function correctly in the CPU module auto exchange mode.

# 23.2 Restoration Function

This function restores backup data in the SD memory card to the CPU module.

## Restoration target folder

Set restoration target data among backup data in the SD memory card with SD956 (Restoration target date folder setting) to SD958 (Restoration target number folder setting). The latest backup data can be restored with b13 (Restoration target folder) of SD955 (Restoration function setting).

Special register	Description
b13 of SD955	Set the restoration function setting with bit patterns. <ul style="list-style-type: none"> <li>• Off: Data specified with the restoration target folders is restored.</li> <li>• On: The latest data is restored.*1</li> </ul>
SD957, SD956	Specify the date folder of the restoration target data in BCD. SD957: Year, SD956: Month and date
SD958	Specify the folder number (00001 to 32767) of restoration target data.

\*1 The latest data is the backup data with the largest number in the newest date folder.

## Restoration target data

Restoration target data is set with SD954 (Restoration target data setting).

Value of SD954	Restoration target data setting
0	All target data
1	Only device/label data
2	All target data excluding device/label data

Note that this function is invalid when restoring with CPU module auto exchange.

## Restoration of the special relay and special register

The setting for whether or not to restore the special relays and special registers differs according to the restoration function being executed.

### ■For restoration triggered by turning SM1354 ON, and automatic restoration using SD955

Set with SD955 (restoration function setting) b14 (special relay, special register restoration).

b14 of SD955	Restoration target data setting
OFF	The special relay and special register are not restored.
ON	The special relay and special register are restored.

### ■Restoration by CPU module auto exchange

The special relay and special register are restored based on the system file for CPU module auto exchange function, so a setting is not required. (☞ Page 212 Restoration of the special relay and special register)

### ■Special relays and special registers that are not restored

Even when restoration is executed, the following special relays and special registers are not restored.

- SM953 (Data backup error check flag)
- SM959 (Data restoration error check flag)
- SM1350 (Data backup status flag)
- SM1351 (Data backup execution request)
- SM1353 (Data restoration status flag)
- SM1354 (Data restoration execution request)
- SM8492 (IP address storage area write request)
- SM8495 (IP address storage area clear request)
- SD953 (Backup error cause)
- SD959 (Restoration error cause)
- SD1350 (Number of uncompleted folders/files of CPU module data backup/restoration)
- SD1351 (Progression status of CPU module data backup/restoration)

## Initialization during automatic restoration

When executing automatic restoration with SD955, set whether or not to initialize the drives other than the SD memory card with SD955 (restoration function setting) b1 (initialize during automatic restoration). This function is valid only when SD954 (restoration target data setting) is 0 (all target data).

b1 of SD955	Restoration target data setting
OFF	Do not initialize.
ON	Initialize.

## Setting of operation after restoration

Set whether after restoration the CPU module operation is to continue from the backup state or from the initialized state with SD955 (restoration function setting) b15 (setting of operation after restoration). The operation of each item using the operation setting after restoration is shown below.

Item	Setting of operation after restoration	
	Continue operation from backed up state(b15 of SD955 = ON)	Operate from initialized state (b15 of SD955 = OFF)
Initial device value	Do not set device initial values after restoration.	Set device initial values after restoration. (Device data from backed up state is overwritten with device initial values.)
SFC program	When "Resume Start" was selected before data backup, the SFC program is resumed after restoration processing.* <sup>1</sup>	The SFC program is not resumed after restoration processing even though "Resume Start" was selected before data restoration.
Event history	Set event history during backup.	Do not set backup event history, and create new file.

\*1 When a battery is not mounted, the start of the SFC program is initial start regardless of setting of operation after restoration. Note that this setting is invalid since the device initial value file, SFC program, and event history file are not restored when the value in SD954 (Restoration target data setting) is 1 (restoration target data are only device/label data). Also, this setting is invalid by restoration with CPU module auto exchange.

## Restoration processing triggered by turning on SM1354

Backup data is restored at a desired timing. When restoration is requested, the CPU module backup data based on the following files in the designated folders are restored.

- System file for backing up CPU module data
- Backup data file for backing up CPU module data
- Device/label data file for backing up CPU module data

### Point

Restoration, triggered by turning on SM1354, should be used to check the backup data or to check the operation before running the main one. To start main working operation of the system with the backup data, use automatic restoration using SD955 or restoration with CPU module auto exchange.

### Restriction

The restoration processing triggered by turning on SM1354 (Data restoration execution request) can be executed only when the CPU module is the STOP state.

## Operating procedure

1. Set restoration target data with SD954 (restoration target data setting).\*<sup>1</sup>
2. Set restoration target folders with SD956 (Restoration target date folder setting) to SD958 (Restoration target number folder setting). (However, this is not required when SD955 (restoration function setting) b13 (restoration target folder) is turned ON in step 3.)
3. Set each setting with the b13 to 15\*<sup>2</sup> of SD955.
4. Set the CPU module to the STOP state.

**5.** Turn on SM1354 (Data restoration execution request).

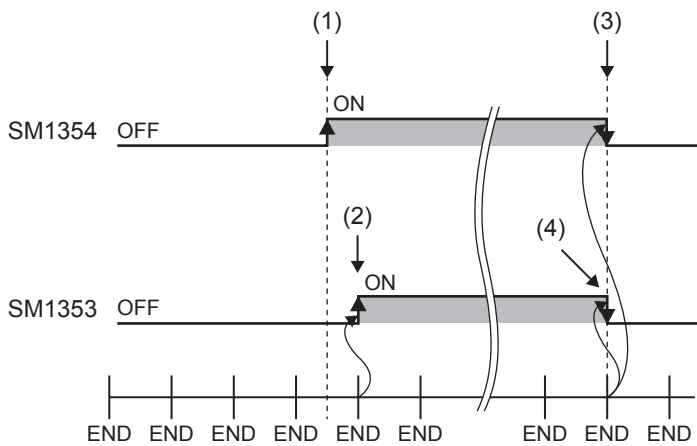

- (1) Turn on SM1354.
- (2) The system turns on SM1353 (Data restoration status flag).
- (3) The system turns off SM1354 after the restoration processing is completed.
- (4) The system turns off SM1353.

\*1 Only 1 (only device/label data) is valid with firmware version of FX5U/FX5UC CPU module earlier than "1.050".

\*2 The b15 (operation after restoration setting) setting is required when the firmware version is "1.050" or later for the FX5U/FX5UC CPU modules.

If the restoration processing is completed with an error and SM959 (Data restoration error check flag) turns on, check SD959 (Restoration error cause), take actions, and then restore the data again as required.

**Point**

The execution status of the restoration processing can be checked with SD1350 (Number of uncompleted folders/files of CPU module data backup/restoration) and SD1351 (Progression status of CPU module data backup/restoration). (Page 212 Progress of the backup/restoration processing)

## Automatic restoration using SD955

Backup data is automatically restored when the CPU module is powered on or is reset. When restoration is executed, the CPU module backup data based on the following files in the designated folders are restored.

- System file for backing up CPU module data
- Backup data file for backing up CPU module data
- Device/label data file for backing up CPU module data

### Operating procedure

1. Set restoration target data with SD954 (restoration target data setting).<sup>\*1</sup>
2. Set restoration target folders with SD956 (Restoration target date folder setting) to SD958 (Restoration target number folder setting). (However, this is not required when SD955 (restoration function setting) b13 (restoration target folder) is turned ON in step 3.)
3. Set each setting with the b1, b13 to 15<sup>\*2</sup> of SD955.
4. Turn on the b0 (Auto restoration request) of SD955.
5. Power off and on or reset the CPU module.

\*1 Only 1 (only device/label data) is valid with firmware version of FX5U/FX5UC CPU module earlier than "1.050".

\*2 The b1 (initialization during automatic restoration) and b15 (operation after restoration setting) settings are required when the firmware version is "1.050" or later for the FX5U/FX5UC CPU modules.

If the restoration processing is completed with an error and SM959 (Data restoration error check flag) turns on, check SD959 (Restoration error cause), take actions, and then restore the data again as required.

**Point**

- Since the special register set for the automatic restoration is a latch area, setting data is held.
- SD955 (Restoration function setting) holds its setting even after the CPU module is powered off and on or is reset. Thus, if the CPU module is powered off and on or is reset while the b0 (Auto restoration request) of SD955 is on, the automatic restoration is executed again. For not performing the automatic restoration when the CPU module is powered off and on or is reset the next time, turn off b0 of SD955 after a restoration is completed and then power off and on or reset the CPU module.

## Restoration triggered by CPU module auto exchange

At power ON or at reset, the backup data is automatically reset without the need for a command. When restoration is executed, the CPU module backup data is restored based on the system file for the CPU module auto exchange function in the SD memory card.

### Restriction

The CPU module auto exchange is executed only when the system file for the CPU module auto exchange function created with backup during the CPU module auto exchange mode is stored on the SD memory card.

### Operating procedure

1. Insert the SD memory card containing the system file for CPU module auto exchange function created with backup during the CPU module auto exchange mode into the CPU module.
2. SM9350 (CPU module auto exchange function enable/disable flag) is turned OFF (enable). (For CPU module backed up with the CPU module auto exchange mode, or CPU module restored with CPU module auto exchange)
3. Power off and on or reset the CPU module.



When the restoration finishes correctly, the system turns SM9350 (CPU module auto exchange function enable/disable flag) ON (disable).

If the restoration processing is completed with an error and SM959 (Data restoration error check flag) turns on, check SD959 (Restoration error cause), take actions, and then restore the data again as required.

### Point

- SM9350 (CPU module auto exchange function enable/disable flag) turns ON (enable) each time restoration is executed with CPU module auto exchange, so unless SM9350 is turned OFF (enable) specifically, restoration with CPU module auto exchange will not be executed each time the power is turned OFF and ON or reset.
- The CPU module target data is restored based on the system file for CPU module auto exchange function so the SD955 (restore function setting) setting is disabled.

### Checking restoration errors

- When an error occurs in the restoration processing triggered by turning on SM1354, a diagnostic error is not detected and an error code is stored in SD959 (Restoration error cause). ( Page 851 List of error codes)
- A diagnosis error will be detected if an error occurs during restoration with the SD955 automatic restoration and CPU module auto exchange. An error code is also stored in SD959. ( Page 851 List of error codes)

# Precautions

The following describes the precautions for the restoration function.

## Prohibited operation during execution of the restoration processing

Do not perform the following operations during execution of the restoration processing.

- Attaching or detaching the SD memory card
- Powering off or resetting the CPU module

The above mentioned operations leave the data in the CPU module in an incomplete state which is in the middle of the restoration processing. Do not run the CPU module with this incomplete state. Doing so may cause an unintended operation. Execute restoration again, or write the data to the CPU module after initialization of the CPU module.

## Suspending the restoration processing

The following operation can suspend a restoration processing.

- Setting the SD memory card forced disable

Suspension during a restoration leaves the data in the CPU module in an incomplete state which is in the middle of the restoration processing. Do not run the CPU module with this incomplete state. Doing so may cause an unintended operation. Execute restoration again, or write the data to the CPU module after initialization of the CPU module.



Automatic restoration using SD955 and restoration using CPU module auto exchange cannot be suspended.

## Types of CPU modules that execute restoration

Make sure CPU module model being restored is the same model as the backup source CPU module. Restoration of different models is not possible.

## When error is occurring in CPU module

Restoration may not be possible if a parameter error is occurring in the CPU module at the restoration destination.

## Changing the operating status during execution of restoration

During execution of the restoration processing, the CPU module remains in the STOP state even if the RUN/STOP/RESET switch is changed from the STOP to RUN position or the remote RUN or the remote PAUSE is executed. The following operation will take place if the CPU module operation status is changed while executing restoration.

- If the restoration target data is all target data or all target data excluding device/label data, the specified operation status will not be entered when restoration is completed.
- If performing restoration without parameter change (parameter of backup date and restoration destination CPU module are same), the specified operation status will be entered.
- The specified operation status is entered after restoration is completed only when the restoration target data is device/label data.
- If performing automatic restoration or restoration with CPU module auto exchange, the specified operation status will be entered when restoration is completed.





## Operations and functions that cannot be performed

While the following operations or functions are being executed, the restoration processing cannot be executed. The following operations and functions cannot be executed during execution of the restoration processing.

Operation or function		
Operation from GX Works3	Initializing the CPU built-in memory/SD memory card	
	Clearing values (Devices, extended file registers, labels, latches)	
	Reading data from the PLC	
	Writing data to the PLC	
	Verifying data with the PLC	
	Deleting data in the PLC	
	Online change	
	Event history function (Updating event history data, clearing event history)	
	File password function	
	Security key authentication function (Writing/deleting a security key to/in the CPU module)	
	Predefined protocol support function (writing/reading/verifying protocol setting data)	
	Memory dump function (Memory dump setting/reading results, registering/clearing memory dump)	
Operation using the CPU module logging configuration tool	Data logging function (Writing/reading/deleting a logging setting file, registering/clearing a logging setting)	
	Operation of a logging file (deletion)	
Others	<ul style="list-style-type: none"> <li>• SLMP</li> <li>• MC protocol</li> </ul>	Remote latch clear
	Ethernet communication	File transfer function (FTP server)
		File transfer function (FTP client)

## Functions that cannot be executed simultaneously with automatic restoration or CPU module auto exchange

Do not execute automatic restoration using SD955, or restoration by automatic restoration using SD955 and CPU module auto exchange simultaneously with the following functions.

- Firmware update function (  Page 89 FIRMWARE UPDATE FUNCTION)
- Boot operation (  Page 230 Boot Operation)

If these are executed simultaneously, automatic restoration or restoration with CPU module auto exchange will not function.

## Operation of when the data logging function is used

If data is backed up during execution of the data logging function and the function has been set to be started automatically when the operating status of the CPU module is changed to RUN, the data logging function will be automatically executed when the status of the CPU module changes to RUN after the restoration processing. To restart the data logging function after the restoration processing without the above setting, use the CPU module logging configuration tool.

## When the SFC program is restarted from where the program was stopped

Specify the continue start. When the continue start has not been specified, the SFC program will be started from the block 0 and step 0 even though the bit 15 of SD955 is on (the continue start is executed).

## When using IP address change function

If executing backup when an IP address is stored in the IP address storage area (system memory), the IP address will change at the following timing during restoration.

- Restoration processing triggered by turning on SM1354: When the CPU module is powered off and on or is reset after the restoration processing
- Automatic restoration using SD955: When the restoration processing is executed
- Restoration triggered by CPU module auto exchange: When restoration is executed.

## Data protected by security functions

### ■File password function

Unlock the file passwords of the files in the backup target CPU module. If any files to which file passwords have been set exist in the CPU module, the files are not restored.

### ■Security key authentication function

Locked programs can be restored regardless of whether security keys have been written or not. However, when the security key has not been written to the CPU module after the restoration processing, the program cannot be executed. Restore unlocked backup data or set the same security key.

## Abnormal completion of restoration

Since the restoration processing will be completed with an error, do not execute the restoration processing in the following cases.

- Data in a backup folder has been deleted. (Do not delete the data in backup folders that are likely to be used for restoration.)
- Backup data has problems. (Backup data has been changed or the CPU module was powered off during execution of the backup processing.)

## When the same name folder or file exists in the restoration target CPU module

If the name of a folder or file in the restoration target CPU module and the name of a folder or file in backup data are identical, the folder or file in the module will be overwritten by that in the backup data.

## Status of the restoration destination CPU module

If the status of the restoration destination CPU module differs from that of the CPU module at the backup processing (such as programs or parameters), the restoration may not be executed.

When the backup data to be restored is backed up in a different status from that of the restoration destination CPU module, store 0 (All target data) to SD954 (Restoration target data setting) and execute the automatic restoration.

## Applying the restored data

There are parameters that are applied only when the CPU module power is turned OFF→ON or reset. Thus, if the data is restored while operation is stopped, and then the state is changed from STOP to RUN, the CPU module may not run with the backed up data. In this case, turn OFF→ON the power or reset the CPU module. The device/label data other than the latch specified devices/labels is initialized when the CPU module power is turned OFF→ON or reset, so restore only the device/label data again as needed.

## Stop monitoring at restoration

Stop monitoring before executing the restoration processing.

When the restoration processing is executed, programs, parameters, and device/label values may not be properly monitored because they are changing.

## Conditions for executing automatic restoration and CPU module auto exchange

The restoration executed for automatic restoration using SD955 and restoration with CPU module auto exchange differs according to the following conditions.

Auto restoration request (b0 of SD955)	CPU module auto exchange function enable/disable flag (SM9350)	Presence of system file for CPU module auto exchange function	Executed restoration
ON	OFF (Enable)	Existing	Restoration triggered by CPU module auto exchange
ON	OFF (Enable)	None	Automatic restoration using SD955
ON	ON (Disable)	None	Automatic restoration using SD955
ON	ON (Disable)	Existing	Automatic restoration using SD955
OFF	OFF (Enable)	Existing	Restoration triggered by CPU module auto exchange
OFF	OFF (Enable)	None	No process
OFF	ON (Disable)	Existing	No process
OFF	ON (Disable)	None	No process

## Time required for completing the restoration processing

It may take some time for restoration to finish if Ethernet communication is in progress.

## The relation between the data to be restored and the firmware version of the CPU module

Do not restore the program with the program capacity setting of 128000 steps to the FX5U/FX5UC CPU module with the firmware version earlier than "1.100". The program may not operate normally. For the program capacity setting, refer to  Page 49 Program Capacity Setting.

# 24 REAL-TIME MONITOR FUNCTION

This function monitors the contents of a specified device of the CPU module in real time with a specified interval or a desired timing. The function can be set with GX LogViewer, where the value changes of a specified device can be shown graphically. Saving the set data and displayed graphs makes it possible to simplify the settings and check the graphs at a later time. For details on the function, refer to  GX LogViewer Version 1 Operating Manual.

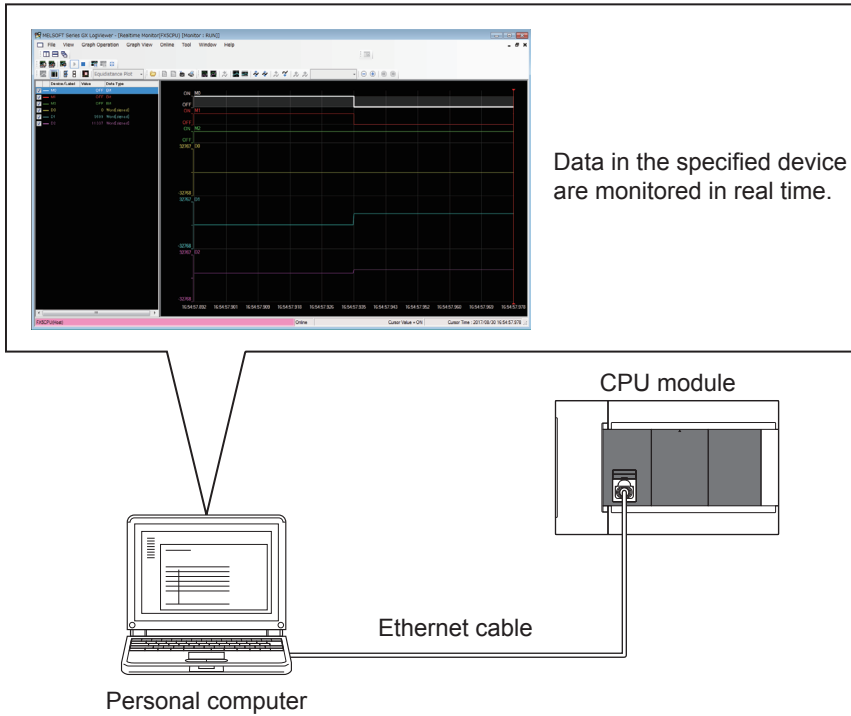

For supported version of real-time monitor function, refer to  Page 966 Added and Enhanced Functions.



# 25 MEMORY CARD FUNCTION

The following explains the functions that use SD memory card.

If an SD memory card is used on the FX5S CPU module, the SD memory card module is required.

## 25.1 SD Memory Card Forced Stop

SD memory card can be disabled without turning power ON→OFF, even when a function that uses SD memory card is being executed, such as when the data logging function is running.

### Methods of SD memory card forced stop

The methods of SD memory card forced stop are as described below.

#### ■Operation by SD memory card disable switch

1. Press the SD memory card access control switch for 1 second or longer.\* 1
2. The CARD LED will flash on → turn off.\* 1\*2
3. Remove the SD card.

\*1 For the SD memory card module, slide and hold the SD memory card access control switch to OFF (upward) for 1 second or longer.

\*2 If there is a function accessing the SD memory card, the CARD LED will flash off after the access of that function is complete. Therefore, the time from flash on to flash off will be different depending on the function.

#### ■Operation by special relay

1. Turn ON SM606 (SD memory card forcibly disable command).

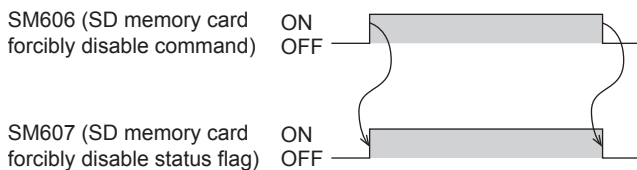

2. Check if CARD LED has turned off or SM607 (SD memory card forcibly disable status flag) has turned ON.
3. Remove the SD card.

## Operation of function accessing SD memory card

The following table shows the operation when the main function is executed while SD memory card is being accessed and when SD memory card is accessed after SD memory card is disabled.

Function under execution		When main function is executed while SD memory card is being accessed	When SD memory card is accessed after SD memory card is disabled
Boot operation		After completing execution function, SD memory card turns to disabled status.	—
<ul style="list-style-type: none"> <li>• Access to the label/device comment in the SD memory card</li> <li>• Device/label initialization operation at STOP→RUN</li> </ul>			CPU module error occurs.*1
Access to the SD memory card by engineering tool/SLMP/file transfer function (FTP server, FTP client)		Error handling occurs.	Error handling occurs.
Data logging function		This function works by disabling data writes to the SD memory card while allowing data collection to continue. (  Page 195 SD memory card replacement)	—
Memory dump function		Error handling occurs.	—
Event history function (Save destination: SD memory card)	Logging of the event history	After the event history in the internal memory is stored in the SD memory card, the SD memory card turns to disabled status.	—*2
	Viewing/clearing the event history	Error handling occurs.	Error handling occurs.
Data backup/restoration function		At completion of the backup/restoration processing of a file, the SD memory card is disabled, the backup/restoration function is completed with an error, and then the cause of error is stored in a special register.	The cause of error is stored in a special register.
Extended file register (ER) function		Extended file register (ER) function is completed with an error, and SD memory card turns to disabled status. Also, a operation error 3586H occurs.	A operation error 3586H occurs.
File operation instruction		The function is completed with an error, and the SD memory card turns to disabled status. 8000H is stored in the completion status of the file operation instruction.	8000H is stored in the completion status of the file operation instruction.

\*1 Operation is same as when the SD memory card is not attached.

\*2 While being removed, the SD memory card is not accessed. ( Page 133 When files are created)

## Releasing the SD memory card forced stop status

After the SD memory card has turned to disable status, release the SD memory card forced stop status by the operation shown below.

1. Load SD card again.\* 1
2. When a forced stop operation is carried out by SM606, turn OFF SM606.

\*1 The CARD LED will blink→light up.

## Precautions

The precaution regarding SD memory card forced stop is described below.

- When a forced stop operation is carried out by both the SD memory card disable switch and by SM606, operation carried out earlier becomes valid, and the operation carried out later becomes invalid. For example, after the forced stop by SD memory card disable switch, when SM606 is turned ON→OFF without removing the SD memory card, the disable status of the SD memory card can be released. After the forced stop by SD memory card disable switch, when SD memory card is removed and then SM606 is turned ON, SM606 operation is ignored.

## 25.2 Boot Operation

At the time of power OFF→ON or reset of the CPU module, a file which is stored on the SD memory card is transferred to the memory of the transfer destination which the CPU module judged automatically.

### Boot operation procedure

The selectable files for boot operation are listed below.

1. Carry out the boot file settings.
2. Load SD memory card.
3. Write the boot file settings and boot file to the SD memory card.\* 1
4. Turn OFF→ON the power or reset the CPU module.

\*1 There are two types of writing method to the SD memory card: Online Data Operation (via the CPU module) and Memory Card Operation (direct from the personal computer). For details, refer to the following.

GX Works3 Operating Manual

### Specifiable file types

The procedure of boot operation is explained below.

- Parameter files (system parameters, CPU parameters, module parameters, module extension parameters)
- Remote password
- Global labels (global label setting files)
- Program files (programs, restored information)
- FB files (FB, restored information)
- Device comments
- Initial device values

### Configuring the boot setting

Carry out the settings required for the boot operation.

Navigation window ⇒ [Parameter] ⇒ [Module model name] ⇒ [Memory Card Parameter] ⇒ [Boot Setting]

#### Operating procedure

"Boot Setting" window

Item	Setting
<b>Boot Setting</b>	
Clear the CPU built-in memory before boot.	Do Not Clear
Boot File Setting	<Detailed Setting>

"Boot File Setting" window

No.	Type	Data Name
1		
2		
3		

"Add Type" window

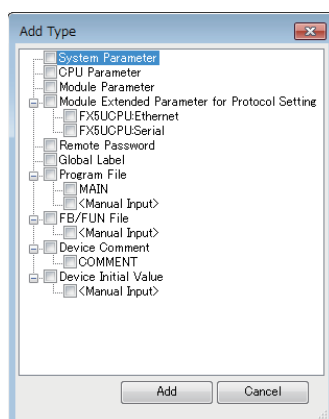

1. Click "Detailed Setting" on the "Boot File Setting" window.
2. Click the "Type" column. The maximum number of boot files that can be specified is the same as the number of files that can be stored in the storage memory.
3. Select type for the boot file. (Multiple selection possible)



"Boot File Setting" window

No.	Type	Data Name
1	System Parameter	SYSTEM
2	CPU Parameter	CPU
3	Module Parameter	UNIT
4	Module Extended Parameter for Protocol Setting(FX5UCPU/Ethernet)	UEX3FF00
5	Module Extended Parameter for Protocol Setting(FX5UCPU/Serial)	UEX3FF01
6	Remote Password	00000001
7	Global Label	GLBLINF
8	Program File	MAIN
9	Program File	
10	FB/FUN File	
11	Device Comment	COMMENT
12	Device Initial Value	

#### 4. Set the data name (file name).

### Displayed items

Item	Description	Setting range	Default
Clear the CPU built-in memory before boot	Sets whether or not to clear the CPU built-in memory upon file transfer from the SD memory card.	<ul style="list-style-type: none"> <li>Do Not Clear</li> <li>Clear</li> </ul>	Do Not Clear
Boot File Setting	Sets the files used for boot operation from the SD memory card.	—	—

### Maximum number of boot files that can be specified

It is the same as the number of files that can be stored in transfer destination memory.

### Operation when security functions are enabled

This section describes the operation when security functions are enabled.

#### ■When a security key is set

When a security key is set to the boot target program file and the security of the program file does not match with that of the CPU module, a boot error occurs. Also, when no security key is written to the CPU module, a boot error occurs as well.

Security key of boot target program file	Security key of CPU module	Security key match/mismatch	Boot program execution
Set	Written	Match	Execute
	Written	Mismatch	Not execute (boot error)
	Not written	—	Not execute (boot error)

#### ■When a file password is set

If a file password is set on both the source boot file and destination file, the file can be transferred only when the passwords match. Furthermore, the file transfer does not work if a file password is set only on either one.

Transferring boot file		Transferred boot file		Password match/mismatch	Transfer
File	File password setting	File	File password setting		
Existing	Set	Existing	Set	Match	Yes
			Mismatch	No	
		Not set	—	No	
	Not set	Existing	Set	—	Yes
			Not set	—	No
		Not set	—	—	Yes

### Precautions

The precautions on the boot operation are explained below.

- The parameter file existing on the module of the transfer destination is overwritten, when a parameter file is set to the boot file. Further, if a parameter file is stored in the SD memory card, but not set to the boot file, the operation will follow the parameter file on the module.
- Note that the model of the program written on the SD memory card (program specified in the boot file settings) and the model of the CPU module must be the same.

# 26 HIGH-SPEED INPUT/OUTPUT FUNCTION

The high-speed input/output function is explained below.

Each respective function is set by parameters in GX Works3.

High-speed pulse input/output module is supported only for FX5UJ and FX5U/FX5UC CPU modules.

Function		Reference
High-speed counter function	Normal mode	Page 246
	Pulse density measurement mode	Page 249
	Rotational speed measurement mode	Page 251
FX3-compatible high-speed counter function		Page 288
Pulse width measurement function		Page 297
Pulse catch function	Pulse catch function	Page 308
	FX3-compatible pulse catch function	Page 313
General-purpose input functions		Page 316
PWM function		Page 319
Positioning function		Page 332

## 26.1 High-speed Counter Function

High-speed counter function is explained below.

### High-speed counter function overview

The high-speed counter is a function that counts the number of high-speed pulse inputs that cannot be counted by a conventional counter, using the general purpose input terminal of the CPU module or high-speed pulse input/output module.

High-speed pulse input/output module is supported only for FX5UJ and FX5U/FX5UC CPU modules.

Depending on the input (module) to be used, each function of the high-speed counter is limited as follows:

○: Supported, ×: Not supported

Input type	High-speed counter operation mode			High-speed counter dedicated instructions	
	Normal mode	Pulse density measurement mode	Rotational speed measurement mode	HIOEN/DHIOEN instruction	DHSCS, DHSCR, DHSZ instruction
CPU module	○	○	○	○	○
High-speed pulse input/output module	○	×	×	○	×

The high-speed counter assigns input and function settings by parameters and operates using the HIOEN/DHIOEN instruction.

#### Point

Parameter setting and the HIOEN/DHIOEN instruction are always required to use the high-speed counter.

### High-speed counter parameter setting

High-speed counter channels (input allocation, function) and high-speed counter comparison table, etc., are set by parameters. (  Page 245 High-speed counter parameters)

### High-speed counter operation mode

The three high-speed counter operation modes are as follows.

Operation mode is set by parameter. (  Page 245 High-speed counter parameters)

#### ■ Normal mode

Select normal mode if you want to use as an ordinary high-speed counter. (  Page 246 High-speed counter (normal mode))

### ■Pulse density measurement mode

Select pulse density measurement mode if you want to count the number of pulses for a specified amount of time. ( Page 249 High-speed counter (pulse density measurement mode))

### ■Rotational speed measurement mode

Select rotational speed measurement mode if you want to measure speed for a specified amount of time. ( Page 251 High-speed counter (rotational speed measurement mode))

## Input comparison

When the current value and the set value of the high-speed counter are compared and when they match, the output of the specified device can be performed. (normal mode) Also, the current value and the preset value can be compared. (Preset input comparison)

Page 254 High-speed comparison table

Page 257 Multiple point output, high-speed comparison tables

The normal input comparison or operation when there is preset input can be set by the parameter setting of the high-speed counter (normal mode).

Item		Description
Preset Input Enable/Disable	Input Comparison Enable/Disable	
Enable	Enable	<ul style="list-style-type: none"> <li>• Perform "comparison at counting + output to the specified device".</li> <li>• Change the current value to the preset value when the preset input is detected.</li> <li>• Perform output to the specified device when the current value matches with the comparison value by the preset input.</li> </ul>
Enable	Disable	<ul style="list-style-type: none"> <li>• Perform "comparison at counting + output to the specified device".</li> <li>• Change the current value to the preset value when the preset input is detected.</li> </ul>
Disable	Disable	Perform "comparison at counting + output to the specified device".

Whether or not to perform the preset input comparison can be set by the special devices. ( Page 266 High-speed counter preset input comparison)

### Point

Use the parameter setting value of the high-speed counter (normal mode) as the preset value. ( Page 246 High-speed counter (normal mode))

## High-speed counter dedicated instructions

The high-speed counter starts and stops counting using the HIOEN/DHIOEN instruction for the high-speed counter. ( MELSEC iQ-F FX5 Programming Manual (Instructions, Standard Functions/Function Blocks))

## Other high-speed counter instructions

In addition to the dedicated instructions, there are instructions such as DHSCS, DHSCR, and DHSZ (hereafter referred to as "high-speed comparison instruction") for high-speed counters.

For details, refer to the following.

MELSEC iQ-F FX5 Programming Manual (Instructions, Standard Functions/Function Blocks)

# High-speed counter function execution procedure

The high-speed counter function execution procedure is as follows.

**1.** Check the specifications of the high-speed counter.

Check specifications such as maximum frequency and type of high-speed counter. (☞ Page 234 High-speed counter specifications)

**2.** Connect the CPU module to the external device.

For details on wiring to external devices, refer to the following manual  
📖 MELSEC iQ-F FX5S/FX5UJ/FX5U/FX5UC User's Manual (Hardware)

**3.** Set the parameters.

Set parameters such as channel (CH) of the high-speed counter. (☞ Page 245 High-speed counter parameters)

**4.** Create the program.

Create program for using the high-speed counter.

**5.** Run the program.

## High-speed counter specifications

High-speed counter specifications are explained below.

### Types of high-speed counters

Types of high-speed counters are as follows.

**■1 phase, 1 input counter (S/W)**

Counting method of 1 phase, 1 input counter (S/W) is as follows.

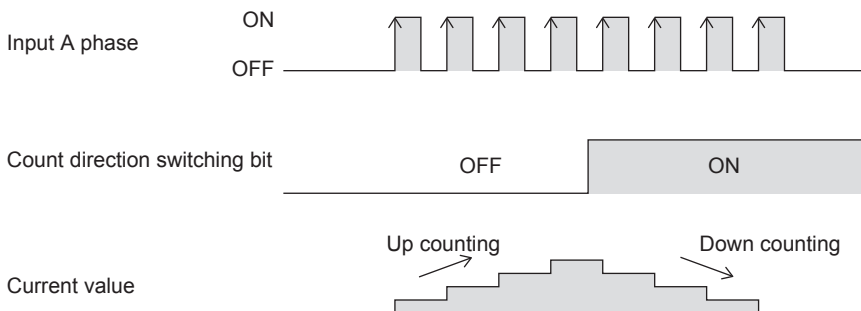

**■1 phase, 1 input counter (H/W)**

Counting method of 1 phase, 1 input counter (H/W) is as follows.

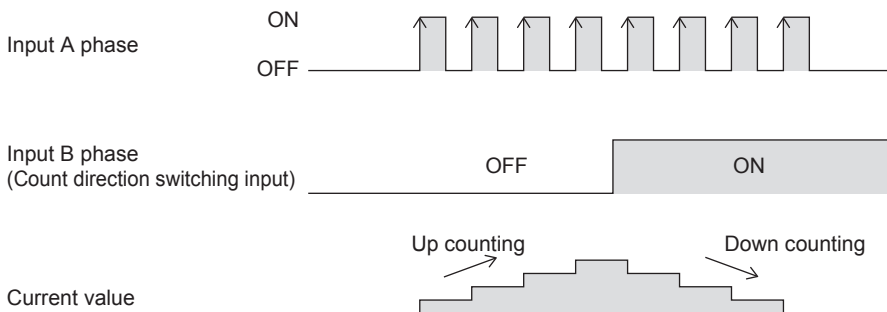

### ■1 phase, 2 input counter

Counting method of 1 phase, 2 input counter is as follows.

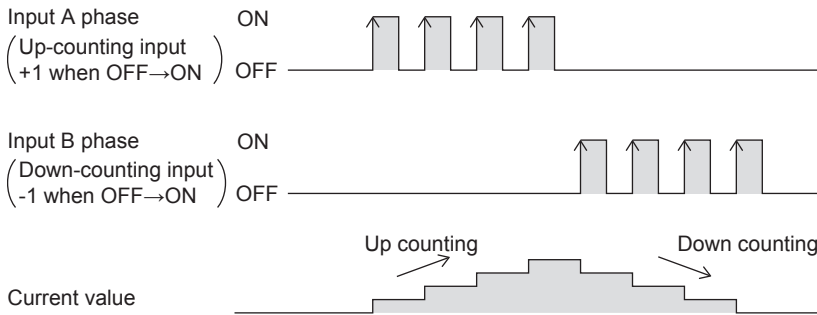

### ■2 phase, 2 input counter [1 edge count]

Counting method of 2 phase, 2 input counter [1 edge count] is as follows.

Up/down counter	Counter timing
At up-counting	1 count up when input A phase is ON and input B phase switches OFF→ON
At down-counting	1 count down when input A phase is ON and input B phase switches ON→OFF

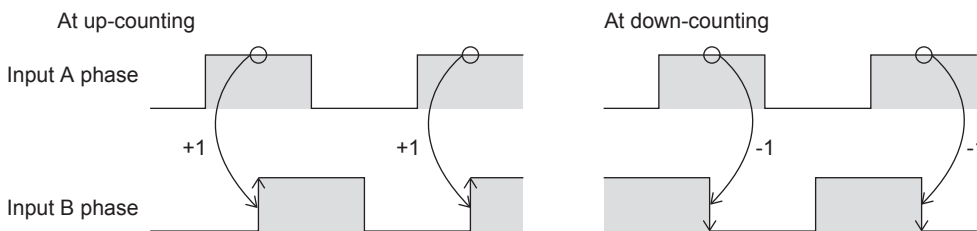

### ■2 phase, 2 input counter [2 edge count]

Counting method of 2 phase, 2 input counter [2 edge count] is as follows.

Up/down counter	Counter timing
At up-counting	1 count up when input A phase is ON and input B phase switches OFF→ON 1 count up when input A phase is OFF and input B phase switches ON→OFF
At down-counting	1 count down when input A phase is ON and input B phase switches ON→OFF 1 count down when input A phase is OFF and input B phase switches OFF→ON

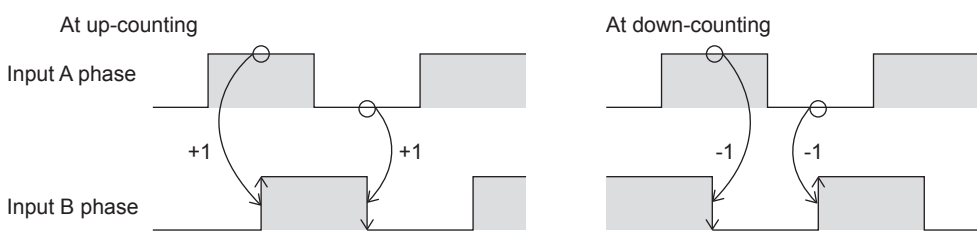

## ■2 phase, 2 input counter [4 edge count]

Counting method of 2 phase, 2 input counter [4 edge count] is as follows.

Up/down counter	Counter timing
At up-counting	1 count up when input B phase is OFF and input A phase switches OFF→ON 1 count up when input A phase is ON and input B phase switches OFF→ON 1 count up when input B phase is ON and input A phase switches ON→OFF 1 count up when input A phase is OFF and input B phase switches ON→OFF
At down-counting	1 count down when input A phase is OFF and input B phase switches OFF→ON 1 count down when input B phase is ON and input A phase switches OFF→ON 1 count down when input A phase is ON and input B phase switches ON→OFF 1 count down when input B phase is OFF and input A phase switches ON→OFF

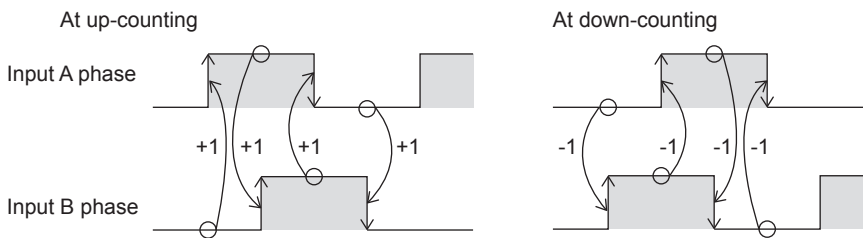

## ■Internal clock

Counting method of internal clock is as follows.

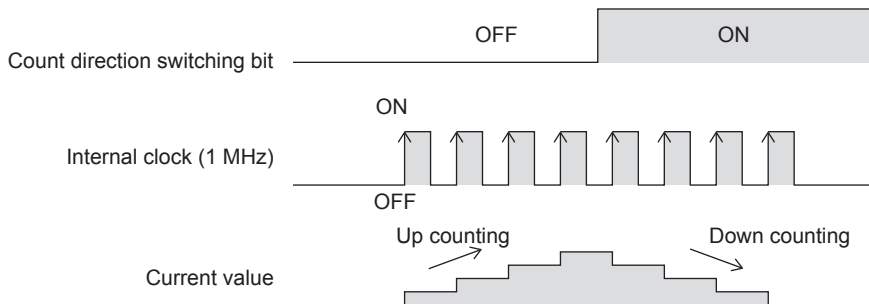

### Point

Under ordinary circumstances, the internal clock counts up/down by 1 MHz clock. External input is not used.

## High-speed counter form

High-speed counter form becomes ring counter depending on the ring length setting.

### ■When ring length is set

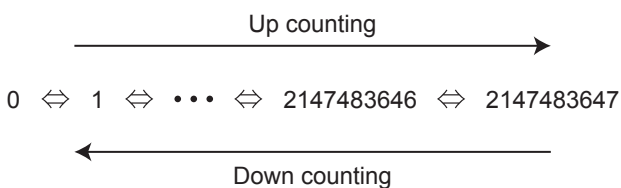

## ■When ring length is not set (ring counter)

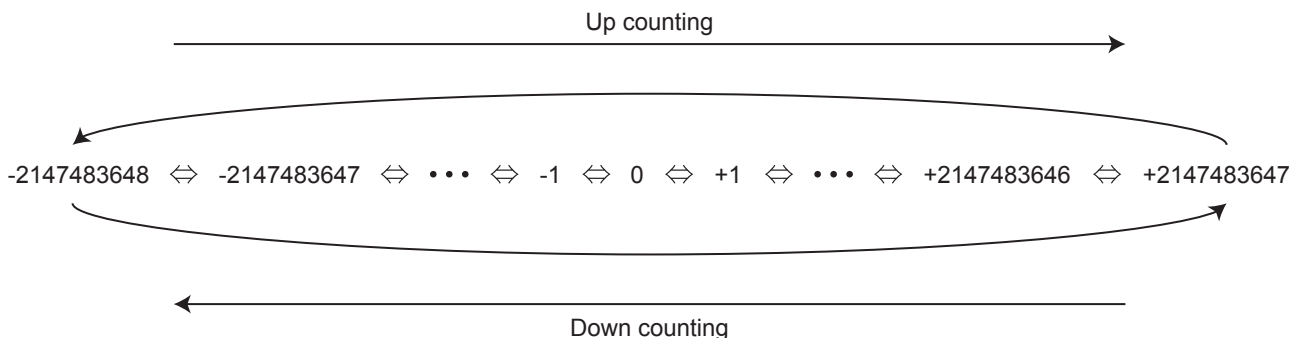

## Maximum frequency

The maximum frequency that each type of counter can count is as follows.

For details concerning maximum frequency by input assignment, refer to Page 241 Input assignment-wise / maximum frequency for high-speed counters.

### ■FX5S/FX5UJ CPU module

Counter type	Maximum frequency
1 phase, 1 input counter (S/W)	100 kHz
1 phase, 1 input counter (H/W)	100 kHz
1 phase, 2 input counter	100 kHz
2 phase, 2 input counter [1 edge count]	100 kHz
2 phase, 2 input counter [2 edge count]	50 kHz
2 phase, 2 input counter [4 edge count]	25 kHz
Internal clock	1 MHz (fixed)

### ■FX5U/FX5UC CPU module

Counter type	Maximum frequency
1 phase, 1 input counter (S/W)	200 kHz
1 phase, 1 input counter (H/W)	200 kHz
1 phase, 2 input counter	200 kHz
2 phase, 2 input counter [1 edge count]	200 kHz
2 phase, 2 input counter [2 edge count]	100 kHz
2 phase, 2 input counter [4 edge count]	50 kHz
Internal clock	1 MHz (fixed)

## Precautions

- The input circuit has restrictions for maximum frequency.

FX5UJ CPU module		Maximum frequency	
X0, X1, X3, X4		100 kHz	
X2, X5, X6, X7		10 kHz	

FX5U-32M□, FX5UC-32M□	FX5U-64M□, FX5U-80M□, FX5UC-64M□, FX5UC-96M□	High-speed pulse input/output module*1	Maximum frequency
X0 to X5	X0 to X7	X□ to X□+5	200kHz
X6 to X17	X10 to X17	X□+6, X□+7	10 kHz

\*1 The number in □ is the head input number for each high-speed pulse input/output module.

- If input response time is set, maximum frequency is affected by the setting value.
- Under ordinary circumstances, the internal clock counts at 1 MHz (fixed) during operation.

## Matched output performance

### ■CPU module

If output is to Y0 to Y17 using high-speed comparison instructions (DHSCS, DHSCR, DHSZ instruction), high-speed comparison table, or multiple point output high-speed comparison table, time from pulse input→comparison of count value (match)→output to Y is follows.

- FX5S/FX5UJ CPU module: 10 $\mu$ s + input response time
- FX5U/FX5UC CPU module: 5 $\mu$ s + input response time

If output is to Y20 or subsequent, time from pulse input to output is affected by communication and user interrupt.

### ■High-speed pulse input/output module

The matched output from the high-speed comparison table is possible only in the same module.

The time from pulse input→comparison of count value (match)→output to Y is 5  $\mu$ s + the input response time.

### ■Operation diagram

An operation diagram is shown below. (Comparison value: 5)

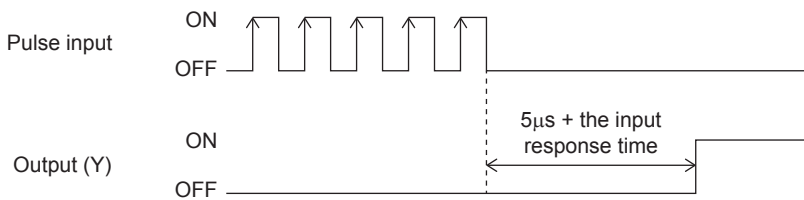

## Count range

-2147483648 to +2147483647. These are signed 32-bit ring counters.

Ring length setting is however in the range of 0 to 2147483647.

## Assignment for high-speed counters

### Input assignment for high-speed counters

Assignment for input devices of high-speed counters is set by parameters.

Assignment is determined according to functions set for each channels by parameter.

When using internal clock, assignment is same as 1-phase, 1-count (S/W) and A phase is not used.

Input assignment of high-speed counters is as follows.

### ■FX5S/FX5UJ CPU module

CH	High-speed counter type	X0	X1	X2	X3	X4	X5	X6	X7	X10	X11	X12	X13	X14	X15	X16	X17
CH1	1-phase 1-count (S/W)	A	P					E									
	1-phase 1-count (H/W)	A	B	P				E									
	1-phase 2-count	A	B	P				E									
	2-phase 2-count	A	B	P				E									
CH2	1-phase 1-count (S/W)		A	P					E								
	1-phase 1-count (H/W)		A	B	P				E								
	1-phase 2-count		A	B	P				E								
CH3	1-phase 1-count (S/W)			A	P					E							
	1-phase 1-count (H/W)			A	B	P				E							
	1-phase 2-count			A	B	P				E							
CH4	1-phase 1-count (S/W)				A	P					E						
	1-phase 1-count (H/W)				A	B	P				E						
	1-phase 2-count				A	B	P				E						
	2-phase 2-count				A	B	P				E						



CH	High-speed counter type	X0	X1	X2	X3	X4	X5	X6	X7	X10	X11	X12	X13	X14	X15	X16	X17
CH5	1-phase 1-count (S/W)					A	P					E					
	1-phase 1-count (H/W)					A	B	P				E					
	1-phase 2-count					A	B	P				E					
CH6	1-phase 1-count (S/W)						A	P					E				
	1-phase 1-count (H/W)						A	B	P				E				
	1-phase 2-count						A	B	P				E				
	2-phase 2-count						A	B	P				E				
CH7	1-phase 1-count (S/W)							A	P					E			
	1-phase 1-count (H/W)							A	B	P				E			
	1-phase 2-count							A	B	P				E			
	2-phase 2-count							A	B	P				E			
CH8	1-phase 1-count (S/W)								A	P					E		
	1-phase 1-count (H/W)								A	B	P				E		

A: Input A phase (In the case of 1-phase 1-count, pulse input is employed and in the case of 1-phase 2-count, pulse input of down-counting direction is employed.)

B: Input B phase (In the case of 1-phase 1-count (H/W), direction switch input is employed and in the case of 1-phase 2-count, pulse input of down-counting direction is employed.)

P: Input external preset

E: Input external enable

#### ■FX5U/FX5UC CPU module

CH	High-speed counter type	X0	X1	X2	X3	X4	X5	X6	X7	X10	X11	X12	X13	X14	X15	X16	X17
CH1	1-phase 1-count (S/W)	A								P	E						
	1-phase 1-count (H/W)	A	B							P	E						
	1-phase 2-count	A	B							P	E						
	2-phase 2-count	A	B							P	E						
CH2	1-phase 1-count (S/W)		A									P	E				
	1-phase 1-count (H/W)			A	B							P	E				
	1-phase 2-count			A	B							P	E				
	2-phase 2-count			A	B							P	E				
CH3	1-phase 1-count (S/W)			A										P	E		
	1-phase 1-count (H/W)					A	B							P	E		
	1-phase 2-count					A	B							P	E		
	2-phase 2-count					A	B							P	E		
CH4	1-phase 1-count (S/W)				A											P	E
	1-phase 1-count (H/W)							A	B							P	E
	1-phase 2-count							A	B							P	E
	2-phase 2-count							A	B							P	E
CH5	1-phase 1-count (S/W)					A				P	E						
	1-phase 1-count (H/W)									A	B	P	E				
	1-phase 2-count									A	B	P	E				
	2-phase 2-count									A	B	P	E				
CH6	1-phase 1-count (S/W)						A					P	E				
	1-phase 1-count (H/W)											A	B	P	E		
	1-phase 2-count											A	B	P	E		
	2-phase 2-count											A	B	P	E		
CH7	1-phase 1-count (S/W)							A						P	E		
	1-phase 1-count (H/W)													A	B	P	E
	1-phase 2-count													A	B	P	E
	2-phase 2-count													A	B	P	E

CH	High-speed counter type	X0	X1	X2	X3	X4	X5	X6	X7	X10	X11	X12	X13	X14	X15	X16	X17
CH8	1-phase 1-count (S/W)								A							P	E
	1-phase 1-count (H/W)															A	B
	1-phase 2-count															A	B
	2-phase 2-count															A	B
CH1 to CH8	Internal clock	Not used															

A: Input A phase

B: Input B phase (direction switch input is however employed in the case of 1-phase 1-count [H/W])

P: Input external preset

E: Input external enable

### High-speed pulse input/output module

□ of each input is the head input number for high-speed pulse input/output module.

CH	High-speed counter type	X□	X□+1	X□+2	X□+3	X□+4	X□+5	X□+6	X□+7
CH9, CH11, CH13, CH15	1-phase 1-count (S/W)	A	P					E	
	1-phase 1-count (H/W)	A	B	P				E	
	1-phase 2-count	A	B	P				E	
	2-phase 2-count	A	B	P				E	
CH10, CH12, CH14, CH16	1-phase 1-count (S/W)				A	P			E
	1-phase 1-count (H/W)				A	B	P		E
	1-phase 2-count				A	B	P		E
	2-phase 2-count				A	B	P		E
CH9 to CH16	Internal clock	Not used							

A: Input A phase

B: Input B phase (direction switch input is however employed in the case of 1-phase 1-count [H/W])

P: Input external preset

E: Input external enable

#### Point

The high-speed pulse input/output module channel numbers are assigned as described below. From nearest to the CPU module, the high-speed pulse input/output modules are ordered as the first module, second module, etc.

- High-speed pulse input/output module first module: CH9, CH10
- High-speed pulse input/output module second module: CH11, CH12
- High-speed pulse input/output module third module: CH13, CH14
- High-speed pulse input/output module fourth module: CH15, CH16

## Input assignment-wise / maximum frequency for high-speed counters

Input assignment-wise maximum frequency for high-speed counters is as follows.

### ■FX5S/FX5UJ CPU module

CH	High-speed counter type	X0	X1	X2	X3	X4	X5	X6	X7	X10	X11	X12	X13	X14	X15	X16	X17	Maximum frequency
CH1	1-phase 1-count (S/W)	A	P					E										100 kHz
	1-phase 1-count (H/W)	A	B	P				E										100 kHz
	1-phase 2-count	A	B	P				E										100 kHz
	2-phase 2-count [1 edge count]	A	B	P				E										100 kHz
	2-phase 2-count [2 edge count]	A	B	P				E										50 kHz
	2-phase 2-count [4 edge count]	A	B	P				E										25 kHz
CH2	1-phase 1-count (S/W)		A	P					E									100 kHz
	1-phase 1-count (H/W)		A	B	P				E									100 kHz
	1-phase 2-count		A	B	P				E									10 kHz
CH3	1-phase 1-count (S/W)			A	P					E								10 kHz
	1-phase 1-count (H/W)			A	B	P				E								10 kHz
	1-phase 2-count			A	B	P				E								10 kHz
CH4	1-phase 1-count (S/W)				A	P					E							100 kHz
	1-phase 1-count (H/W)				A	B	P				E							100 kHz
	1-phase 2-count				A	B	P				E							100 kHz
	2-phase 2-count [1 edge count]				A	B	P				E							100 kHz
	2-phase 2-count [2 edge count]				A	B	P				E							50 kHz
	2-phase 2-count [4 edge count]				A	B	P				E							25 kHz
CH5	1-phase 1-count (S/W)					A	P					E						100 kHz
	1-phase 1-count (H/W)					A	B	P				E						100 kHz
	1-phase 2-count					A	B	P				E						10 kHz
CH6	1-phase 1-count (S/W)						A	P					E					10 kHz
	1-phase 1-count (H/W)						A	B	P				E					10 kHz
	1-phase 2-count						A	B	P				E					10 kHz
	2-phase 2-count [1 edge count]						A	B	P				E					10 kHz
	2-phase 2-count [2 edge count]						A	B	P				E					5 kHz
	2-phase 2-count [4 edge count]						A	B	P				E					2.5 kHz
CH7	1-phase 1-count (S/W)							A	P					E				10 kHz
	1-phase 1-count (H/W)							A	B	P				E				10 kHz
	1-phase 2-count							A	B	P				E				10 kHz
	2-phase 2-count [1 edge count]							A	B	P				E				10 kHz
	2-phase 2-count [2 edge count]							A	B	P				E				5 kHz
	2-phase 2-count [4 edge count]							A	B	P				E				2.5 kHz
CH8	1-phase 1-count (S/W)								A	P					E			10 kHz
	1-phase 1-count (H/W)								A	B	P				E			10 kHz

A: Input A phase, B: Input B phase, P: Input external preset, E: Input external enable

## ■FX5U-32M□, FX5UC-32M□

### Point

- X6 to X17 are input frequencies up to 10 kHz, regardless of maximum frequency value.
- Preset input and Enable Input are input frequencies up to 10 kHz, regardless of maximum frequency value.

CH	High-speed counter type	X0	X1	X2	X3	X4	X5	X6	X7	X10	X11	X12	X13	X14	X15	X16	X17	Maximum frequency
CH1	1-phase 1-count (S/W)	A								P	E							200 kHz
	1-phase 1-count (H/W)	A	B							P	E							200 kHz
	1-phase 2-count	A	B							P	E							200 kHz
	2-phase 2-count [1 edge count]	A	B							P	E							200 kHz
	2-phase 2-count [2 edge count]	A	B							P	E							100 kHz
	2-phase 2-count [4 edge count]	A	B							P	E							
CH2	1-phase 1-count (S/W)		A									P	E					200 kHz
	1-phase 1-count (H/W)			A	B							P	E					200 kHz
	1-phase 2-count			A	B							P	E					200 kHz
	2-phase 2-count [1 edge count]			A	B							P	E					200 kHz
	2-phase 2-count [2 edge count]			A	B							P	E					100 kHz
	2-phase 2-count [4 edge count]			A	B							P	E					50 kHz
CH3	1-phase 1-count (S/W)			A										P	E			200 kHz
	1-phase 1-count (H/W)					A	B							P	E			200 kHz
	1-phase 2-count					A	B							P	E			200 kHz
	2-phase 2-count [1 edge count]					A	B							P	E			200 kHz
	2-phase 2-count [2 edge count]					A	B							P	E			100 kHz
	2-phase 2-count [4 edge count]					A	B							P	E			50 kHz
CH4	1-phase 1-count (S/W)				A											P	E	200 kHz
	1-phase 1-count (H/W)							A	B							P	E	10 kHz
	1-phase 2-count							A	B							P	E	10 kHz
	2-phase 2-count [1 edge count]							A	B							P	E	10 kHz
	2-phase 2-count [2 edge count]							A	B							P	E	5 kHz
	2-phase 2-count [4 edge count]							A	B							P	E	2.5 kHz
CH5	1-phase 1-count (S/W)					A				P	E							200 kHz
	1-phase 1-count (H/W)									A	B	P	E					10 kHz
	1-phase 2-count									A	B	P	E					10 kHz
	2-phase 2-count [1 edge count]									A	B	P	E					10 kHz
	2-phase 2-count [2 edge count]									A	B	P	E					5 kHz
	2-phase 2-count [4 edge count]									A	B	P	E					2.5 kHz

CH	High-speed counter type	X0	X1	X2	X3	X4	X5	X6	X7	X10	X11	X12	X13	X14	X15	X16	X17	Maximum frequency
CH6	1-phase 1-count (S/W)						A					P	E					200 kHz
	1-phase 1-count (H/W)											A	B	P	E			10 kHz
	1-phase 2-count											A	B	P	E			10 kHz
	2-phase 2-count [1 edge count]											A	B	P	E			10 kHz
	2-phase 2-count [2 edge count]											A	B	P	E			5 kHz
	2-phase 2-count [4 edge count]											A	B	P	E			2.5 kHz
CH7	1-phase 1-count (S/W)							A						P	E			10 kHz
	1-phase 1-count (H/W)													A	B	P	E	10 kHz
	1-phase 2-count													A	B	P	E	10 kHz
	2-phase 2-count [1 edge count]													A	B	P	E	10 kHz
	2-phase 2-count [2 edge count]													A	B	P	E	5 kHz
	2-phase 2-count [4 edge count]													A	B	P	E	2.5 kHz
CH8	1-phase 1-count (S/W)								A							P	E	10 kHz
	1-phase 1-count (H/W)															A	B	10 kHz
	1-phase 2-count															A	B	10 kHz
	2-phase 2-count [1 edge count]															A	B	10 kHz
	2-phase 2-count [2 edge count]															A	B	5 kHz
	2-phase 2-count [4 edge count]															A	B	2.5 kHz

A: Input A phase, B: Input B phase, P: Input external preset, E: Input external enable

■FX5U-64M□, FX5U-80M□, FX5UC-64M□, FX5UC-96M□



- X10 to X17 are input frequencies up to 10 kHz, regardless of maximum frequency value.
- Preset input and Enable Input are input frequencies up to 10 kHz, regardless of maximum frequency value.

CH	High-speed counter type	X0	X1	X2	X3	X4	X5	X6	X7	X10	X11	X12	X13	X14	X15	X16	X17	Maximum frequency
CH1	1-phase 1-count (S/W)	A								P	E							200 kHz
	1-phase 1-count (H/W)	A	B							P	E							200 kHz
	1-phase 2-count	A	B							P	E							200 kHz
	2-phase 2-count [1 edge count]	A	B							P	E							200 kHz
	2-phase 2-count [2 edge count]	A	B							P	E							100 kHz
	2-phase 2-count [4 edge count]	A	B							P	E							50 kHz
CH2	1-phase 1-count (S/W)		A									P	E					200 kHz
	1-phase 1-count (H/W)			A	B							P	E					200 kHz
	1-phase 2-count			A	B							P	E					200 kHz
	2-phase 2-count [1 edge count]			A	B							P	E					200 kHz
	2-phase 2-count [2 edge count]			A	B							P	E					100 kHz
	2-phase 2-count [4 edge count]			A	B							P	E					50 kHz

CH	High-speed counter type	X0	X1	X2	X3	X4	X5	X6	X7	X10	X11	X12	X13	X14	X15	X16	X17	Maximum frequency
CH3	1-phase 1-count (S/W)			A										P	E			200 kHz
	1-phase 1-count (H/W)					A	B							P	E			200 kHz
	1-phase 2-count					A	B							P	E			200 kHz
	2-phase 2-count [1 edge count]					A	B							P	E			200 kHz
	2-phase 2-count [2 edge count]					A	B							P	E			100 kHz
	2-phase 2-count [4 edge count]					A	B							P	E			50 kHz
CH4	1-phase 1-count (S/W)				A											P	E	200 kHz
	1-phase 1-count (H/W)							A	B							P	E	200 kHz
	1-phase 2-count							A	B							P	E	200 kHz
	2-phase 2-count [1 edge count]							A	B							P	E	200 kHz
	2-phase 2-count [2 edge count]							A	B							P	E	100 kHz
	2-phase 2-count [4 edge count]							A	B							P	E	50 kHz
CH5	1-phase 1-count (S/W)					A				P	E							200 kHz
	1-phase 1-count (H/W)									A	B	P	E					10 kHz
	1-phase 2-count									A	B	P	E					10 kHz
	2-phase 2-count [1 edge count]									A	B	P	E					10 kHz
	2-phase 2-count [2 edge count]									A	B	P	E					5 kHz
	2-phase 2-count [4 edge count]									A	B	P	E					2.5 kHz
CH6	1-phase 1-count (S/W)						A					P	E					200 kHz
	1-phase 1-count (H/W)											A	B	P	E			10 kHz
	1-phase 2-count											A	B	P	E			10 kHz
	2-phase 2-count [1 edge count]											A	B	P	E			10 kHz
	2-phase 2-count [2 edge count]											A	B	P	E			5 kHz
	2-phase 2-count [4 edge count]											A	B	P	E			2.5 kHz
CH7	1-phase 1-count (S/W)							A						P	E			200 kHz
	1-phase 1-count (H/W)													A	B	P	E	10 kHz
	1-phase 2-count													A	B	P	E	10 kHz
	2-phase 2-count [1 edge count]													A	B	P	E	10 kHz
	2-phase 2-count [2 edge count]													A	B	P	E	5 kHz
	2-phase 2-count [4 edge count]													A	B	P	E	2.5 kHz
CH8	1-phase 1-count (S/W)								A							P	E	200 kHz
	1-phase 1-count (H/W)															A	B	10 kHz
	1-phase 2-count															A	B	10 kHz
	2-phase 2-count [1 edge count]															A	B	10 kHz
	2-phase 2-count [2 edge count]															A	B	5 kHz
	2-phase 2-count [4 edge count]															A	B	2.5 kHz

A: Input A phase, B: Input B phase, P: Input external preset, E: Input external enable

## High-speed pulse input/output module

### Point

- X□+6 and X□+7 are input frequencies up to 10 kHz, regardless of maximum frequency value.
- Preset input and Enable Input are input frequencies up to 10 kHz, regardless of maximum frequency value.

□ of each input is the head input number for high-speed pulse input/output module.

CH	High-speed counter type	X□	X□+1	X□+2	X□+3	X□+4	X□+5	X□+6	X□+7	Maximum frequency
CH9, CH11, CH13, CH15	1-phase 1-count (S/W)	A	P					E		200 kHz
	1-phase 1-count (H/W)	A	B	P				E		200 kHz
	1-phase 2-count	A	B	P				E		200 kHz
	2-phase 2-count [1 edge count]	A	B	P				E		200 kHz
	2-phase 2-count [2 edge count]	A	B	P				E		100 kHz
	2-phase 2-count [4 edge count]	A	B	P				E		50 kHz
CH10, CH12, CH14, CH16	1-phase 1-count (S/W)				A	P			E	200 kHz
	1-phase 1-count (H/W)				A	B	P		E	200 kHz
	1-phase 2-count				A	B	P		E	200 kHz
	2-phase 2-count [1 edge count]				A	B	P		E	200 kHz
	2-phase 2-count [2 edge count]				A	B	P		E	100 kHz
	2-phase 2-count [4 edge count]				A	B	P		E	50 kHz

A: Input A phase, B: Input B phase, P: Input external preset, E: Input external enable

## High-speed counter parameters

High-speed counter parameters are explained below.

High-speed counter parameters are set by GX Works3.

### Outline of parameters

High-speed counter settings, high-speed comparison table, multiple point output high-speed comparison table and input response time are set by parameters.







The primary items that can be set by parameters are as follows.

- Basic settings
- High-speed comparison table setting
- Multiple point output high-speed table setting
- Input response time setting

### Parameter setting

High-speed counter parameter setting method is explained below.

For parameter setting of each operation, refer to the following.

- For high-speed counters (normal mode), refer to  Page 246 High-speed counter (normal mode).
- For high-speed counter (pulse density measurement mode), refer to  Page 249 High-speed counter (pulse density measurement mode).
- For high-speed counter (rotational speed measurement mode), refer to  Page 251 High-speed counter (rotational speed measurement mode).
- For high-speed comparison table, refer to  Page 254 High-speed comparison table.
- For multiple point output, high-speed comparison tables, refer to  Page 257 Multiple point output, high-speed comparison tables.
- For input response time, refer to  Page 316 General-purpose Input Functions.

Parameters are enabled when the CPU module is powered ON or after a reset. In addition, operations different from the parameter settings are possible by transferring values to special relays and special registers while changing these values in the program.

For details concerning special relays and special registers for high-speed counters, refer to Page 772 Special Relay List, Page 799 Special Register List.

## High-speed counter (normal mode)

Normal mode for high-speed counters is explained below.

Use normal mode if you want to use as an ordinary high-speed counter.

### Parameter setting

Set operation mode to normal mode by high-speed counter parameter setting.

Sets detailed settings for channel used.

#### ■CPU module

Navigation window ⇒ [Parameter] ⇒ [Module model name] ⇒ [Module Parameter] ⇒ [High Speed I/O] ⇒ "Input Function" ⇒ "High Speed Counter" ⇒ "Detailed Setting" ⇒ "Basic Settings"

### Window

Item	CH1	CH2	CH3
<input type="checkbox"/> <b>Use/Do Not Use Counter</b>	<b>Set whether to use counter or not.</b>		
Use/Not Use	Enable	Enable	Enable
<input type="checkbox"/> <b>Operation Mode</b>	<b>Set operation mode.</b>		
Operation Mode	Normal Mode	Normal Mode	Normal Mode
<input type="checkbox"/> <b>Pulse Input Mode</b>	<b>Set pulse input mode.</b>		
Pulse Input Mode	1-Phase 1 Input (S/W Up/Down Switch)	1 Phase 2 Input	2 Phase 4 Multiple
<input type="checkbox"/> <b>Preset Input</b>	<b>Set preset input.</b>		
Preset Input Enable/Disable	Disable	Enable	Disable
Input logic	Positive Logic	Positive Logic	Positive Logic
Input Comparison Enable/Disable	Disable	Disable	Disable
Control Switch	Rising	Falling	Rising
<input type="checkbox"/> <b>Preset Value</b>			
Preset Value	0	100	200
<input type="checkbox"/> <b>Enable Input</b>	<b>Set enable input.</b>		
Enable Input Enable/Disable	Disable	Disable	Enable
Input logic	Positive Logic	Positive Logic	Negative Logic
<input type="checkbox"/> <b>Ring Length Setting</b>	<b>Set ring length.</b>		
Ring Length Enable/Disable	Disable	Disable	Enable
Ring Length			50000
<input type="checkbox"/> <b>Measurement Unit Time</b>	<b>Set the measurement unit time (ms) for the pulse density measurement mode and rotation speed measurement mode.</b>		
Measurement Unit Time			
<input type="checkbox"/> <b>No. of Pulse per Rotation</b>	<b>Set the number of pulses per rotation when using the rotation speed measurement mode.</b>		
No. of Pulse per Rotation			

### Displayed items

Item	Description	Setting range	Default
Use/Not Use	Set whether use counter or not.	<ul style="list-style-type: none"> <li>• Disable</li> <li>• Enable</li> </ul>	Disable
Operation Mode	Set operation mode.	<ul style="list-style-type: none"> <li>• Normal Mode</li> <li>• Pulse Density Assumption Mode</li> <li>• Rotation Speed Measurement Mode</li> </ul>	—
Pulse Input Mode	Set pulse input mode.	<ul style="list-style-type: none"> <li>• 1-Phase 1 Input (S/W Up/Down Switch)</li> <li>• 1-Phase 1 Input (H/W Up/Down Switch)</li> <li>• 1 Phase 2 Input</li> <li>• 2 Phase 1 Multiple</li> <li>• 2 Phase 2 Multiple</li> <li>• 2 Phase 4 Multiple</li> <li>• Internal Clock (1MHz)</li> </ul>	—



Item	Description	Setting range	Default
Preset Input Enable/Disable	Set the preset value when preset input is enabled. Change the current value to the preset value when the preset is detected. The preset value cannot be set when the preset input is disabled.	<ul style="list-style-type: none"> <li>• Disable</li> <li>• Enable</li> </ul>	—
Input logic	Sets preset input logic when preset input is enabled.	<ul style="list-style-type: none"> <li>• Positive Logic</li> <li>• Negative Logic</li> </ul>	—
Input Comparison Enable/Disable	Perform output to the specified device when input comparison is enabled and the current value matches with the comparison value by the preset input. Output to the specified device is not performed when input comparison is disabled and the current value matches with the comparison value by the preset input.	<ul style="list-style-type: none"> <li>• Disable</li> <li>• Enable</li> </ul>	—
Control Switch	Sets preset execution timing when preset input is enabled.	<ul style="list-style-type: none"> <li>• Rising</li> <li>• Falling</li> <li>• Rising + Falling Edge</li> <li>• Always During Input ON</li> </ul>	—
Preset Value	Sets preset value when preset input is enabled.	-2147483648 to +2147483647	—
Enable Input Enable/Disable	Set whether to "enable" or "disable" the enable input.	<ul style="list-style-type: none"> <li>• Disable</li> <li>• Enable</li> </ul>	—
Input logic	Set the enable input logic value.	<ul style="list-style-type: none"> <li>• Positive Logic</li> <li>• Negative Logic</li> </ul>	—
Ring Length Enable/Disable	Sets whether to "enable" or "disable" the ring length for ring counters.	<ul style="list-style-type: none"> <li>• Disable</li> <li>• Enable</li> </ul>	—
Ring Length	Sets ring length when ring length setting is enabled.	2 to 2147483648	—
Measurement Unit Time	Not available for high-speed counters (normal mode).	—	—
No. of Pulse per Rotation			

### ■High-speed pulse input/output module

Add the high-speed pulse input/output module.

Navigation window ⇒ [Parameter] ⇒ [Module Information] ⇒ Right-click ⇒ Add New Module

After adding the high-speed pulse input/output module, make settings on the screen displayed from the following operation.

Navigation window ⇒ [Parameter] ⇒ [Module Information] ⇒ [1 to 16 (high-speed pulse input/output module)] ⇒ [Module Parameter] ⇒ "Input Function" ⇒ "High Speed Counter" ⇒ "Detailed Setting" ⇒ "Basic Settings"

### Window

Item	CH9	CH10
<b>Use/Do Not Use Counter</b>	<b>Set whether to use counter or not.</b>	
Use/Not Use	Enable	Enable
<b>Operation Mode</b>	<b>Set operation mode.</b>	
Operation Mode	Normal Mode	Normal Mode
<b>Pulse Input Mode</b>	<b>Set pulse input mode.</b>	
Pulse Input Mode	1-Phase 1 Input (S/W Up/Down Switch)	1-Phase 1 Input (S/W Up/Down Switch)
<b>Preset Input</b>	<b>Set preset input.</b>	
Preset Input Enable/Disable	Disable	Enable
Input logic	Positive Logic	Positive Logic
Input Comparison Enable/Disable	Disable	Enable
Control Switch	Rising	Falling
<b>Preset Value</b>		
Preset Value	0	5000
<b>Enable Input</b>	<b>Set enable input.</b>	
Enable Input Enable/Disable	Disable	Enable
Input logic	Positive Logic	Negative Logic
<b>Ring Length Setting</b>	<b>Set ring length.</b>	
Ring Length Enable/Disable	Disable	Enable
Ring Length		10000



Shown above is the screen at the time when the first high-speed pulse input/output module is selected.

## Displayed items

Item	Description	Setting range	Default
Use/Not Use	Set whether use counter or not.	<ul style="list-style-type: none"> <li>• Disable</li> <li>• Enable</li> </ul>	Disable
Operation Mode	Set operation mode. The mode is fixed to Normal Mode.	Normal Mode	—
Pulse Input Mode	Set pulse input mode.	<ul style="list-style-type: none"> <li>• 1-Phase 1 Input (S/W Up/Down Switch)</li> <li>• 1-Phase 1 Input (H/W Up/Down Switch)</li> <li>• 1 Phase 2 Input</li> <li>• 2 Phase 1 Multiple</li> <li>• 2 Phase 2 Multiple</li> <li>• 2 Phase 4 Multiple</li> <li>• Internal Clock (1MHz)</li> </ul>	—
Preset Input Enable/Disable	Set whether to "enable" or "disable" the preset input of counter.	<ul style="list-style-type: none"> <li>• Disable</li> <li>• Enable</li> </ul>	—
Input logic	Sets preset input logic when preset input is enabled.	<ul style="list-style-type: none"> <li>• Positive Logic</li> <li>• Negative Logic</li> </ul>	—
Input Comparison Enable/Disable	Sets whether to "enable" or "disable" input comparison when preset input is enabled.	<ul style="list-style-type: none"> <li>• Disable</li> <li>• Enable</li> </ul>	—
Control Switch	Sets preset execution timing when preset input is enabled.	<ul style="list-style-type: none"> <li>• Rising</li> <li>• Falling</li> <li>• Rising + Falling Edge</li> <li>• Always During Input ON</li> </ul>	—
Preset Value	Sets preset value when preset input is enabled.	-2147483648 to +2147483647	—
Enable Input Enable/Disable	Set whether to "enable" or "disable" the enable input.	<ul style="list-style-type: none"> <li>• Disable</li> <li>• Enable</li> </ul>	—
Input logic	Set the enable input logic value.	<ul style="list-style-type: none"> <li>• Positive Logic</li> <li>• Negative Logic</li> </ul>	—
Ring Length Enable/Disable	Sets whether to "enable" or "disable" the ring length for ring counters.	<ul style="list-style-type: none"> <li>• Disable</li> <li>• Enable</li> </ul>	—
Ring Length	Sets ring length when ring length setting is enabled.	2 to 2147483648	—

### Point

Parameters are enabled when the CPU module is powered ON or after a reset. In addition, operations different from the parameter settings are possible by transferring values to special relays and special registers while changing these values in the program.

For details concerning special relays and special registers for high-speed counters, refer to  Page 772 Special Relay List,  Page 799 Special Register List.

## Starting/stopping high-speed counter measurement

High-speed counters cannot count by setting the parameter alone.

The HIOEN/DHIOEN instruction is required to start/stop the count.

For the HIOEN/DHIOEN instruction, refer to  MELSEC iQ-F FX5 Programming Manual (Instructions, Standard Functions/Function Blocks).

## Read/write of current value of high-speed counter

The current value of the high-speed counter is stored in a special register for each channel. You can check current value by monitoring the value. The value may however differ from the actual value because the special register is updated during END processing.

You can read the latest value using the HCMOV/DHCMOV instruction.

For details concerning special registers for high-speed counters, refer to  Page 799 Special Register List.

For information for the HCMOV/DHCMOV instruction, refer to  MELSEC iQ-F FX5 Programming Manual (Instructions, Standard Functions/Function Blocks).

## Precautions

- Input used varies according to channel selected and pulse input mode.
- If not using preset input or enable input, you can use it as input for other functions.
- If mode is other than normal mode, preset input cannot be used.
- Use the HIOEN/DHIOEN instruction to start high-speed counter measurement.
- There are common precautions when using high-speed counters. For details, refer to  Page 283 Precautions when using high-speed counters.

## High-speed counter (pulse density measurement mode)

The pulse density measurement mode for high-speed counters is explained below. The pulse density measurement mode is not supported in high-speed pulse input/output modules.

When in pulse density measurement mode, pulse is counted from count input of the high-speed counter, and the number of pulses for a specified amount of time is automatically counted.

### Parameter setting

Set operation mode to pulse density measurement mode by high-speed counter parameter setting.

Sets detailed settings for channel used.

 Navigation window ⇒ [Parameter] ⇒ [Module model name] ⇒ [Module Parameter] ⇒ [High Speed I/O] ⇒ "Input Function" ⇒ "High Speed Counter" ⇒ "Detailed Setting" ⇒ "Basic Settings"

### Window

Item	CH1	CH2	CH3
<input type="checkbox"/> <b>Use/Do Not Use Counter</b>	<b>Set whether to use counter or not.</b>		
Use/Not Use	Enable	Enable	Enable
<input type="checkbox"/> <b>Operation Mode</b>	<b>Set operation mode.</b>		
Operation Mode	Pulse Density Measurement Mode	Pulse Density Measurement Mode	Pulse Density Measurement Mode
<input type="checkbox"/> <b>Pulse Input Mode</b>	<b>Set pulse input mode.</b>		
Pulse Input Mode	1-Phase 1 Input (S/W Up/Down Switch)	1-Phase 1 Input (H/W Up/Down Switch)	2 Phase 2 Multiple
<input type="checkbox"/> <b>Preset Input</b>	<b>Set preset input.</b>		
Preset Input Enable/Disable	Disable	Disable	Disable
Input logic	Positive Logic	Positive Logic	Positive Logic
Input Comparison Enable/Disable	Disable	Disable	Disable
Control Switch	Rising	Rising	Rising
<input type="checkbox"/> <b>Preset Value</b>			
Preset Value	0	0	0
<input type="checkbox"/> <b>Enable Input</b>	<b>Set enable input.</b>		
Enable Input Enable/Disable	Disable	Disable	Disable
Input logic	Positive Logic	Positive Logic	Positive Logic
<input type="checkbox"/> <b>Ring Length Setting</b>	<b>Set ring length.</b>		
Ring Length Enable/Disable	Disable	Disable	Disable
Ring Length			
<input type="checkbox"/> <b>Measurement Unit Time</b>	<b>Set the measurement unit time (ms) for the pulse density measurement mode and rotation speed measurement mode.</b>		
Measurement Unit Time	1000	2000	30000
<input type="checkbox"/> <b>No. of Pulse per Rotation</b>	<b>Set the number of pulses per rotation when using the rotation speed measurement mode.</b>		
No. of Pulse per Rotation			

### Displayed items

Item	Description	Setting range	Default
Use/Not Use	Set whether use counter or not.	<ul style="list-style-type: none"> <li>• Disable</li> <li>• Enable</li> </ul>	Disable
Operation Mode	Set operation mode.	<ul style="list-style-type: none"> <li>• Normal Mode</li> <li>• Pulse Density Assumption Mode</li> <li>• Rotation Speed Measurement Mode</li> </ul>	—

Item	Description	Setting range	Default
Pulse Input Mode	Set pulse input mode.	<ul style="list-style-type: none"> <li>• 1-Phase 1 Input (S/W Up/Down Switch)</li> <li>• 1-Phase 1 Input (H/W Up/Down Switch)</li> <li>• 1 Phase 2 Input</li> <li>• 2 Phase 1 Multiple</li> <li>• 2 Phase 2 Multiple</li> <li>• 2 Phase 4 Multiple</li> <li>• Internal Clock (1MHz)</li> </ul>	—
Preset Input Enable/Disable	Not available for high-speed counters (pulse density measurement mode).	—	—
Input logic			
Input Comparison Enable/Disable			
Control Switch			
Preset Value			
Enable Input Enable/Disable	Set whether to "enable" or "disable" the enable input.	<ul style="list-style-type: none"> <li>• Disable</li> <li>• Enable</li> </ul>	—
Input logic	Set the enable input logic value.	<ul style="list-style-type: none"> <li>• Positive Logic</li> <li>• Negative Logic</li> </ul>	—
Ring Length Enable/Disable	Not available for high-speed counters (pulse density measurement mode).	—	—
Ring Length			
Measurement Unit Time	Set measurement unit time. (Unit: ms)	1 to 2147483647	—
No. of Pulse per Rotation	Not available for high-speed counters (pulse density measurement mode).	—	—

### Point

Parameters are enabled when the CPU module is powered ON or after a reset. In addition, operations different from the parameter settings are possible by transferring values to special relays and special registers while changing these values in the program.

For details concerning special relays and special registers for high-speed counters, refer to [Page 772 Special Relay List](#), [Page 799 Special Register List](#).

## Pulse density measurement mode start/stop

The pulse density measurement mode cannot measure by setting the parameter alone.

The HIOEN/DHIOEN instruction is required to start/stop measurement.

For the HIOEN/DHIOEN instruction, refer to [MELSEC iQ-F FX5 Programming Manual \(Instructions, Standard Functions/Function Blocks\)](#).

## Pulse density

Pulse density is stored in the special register for each channel.

For details concerning special registers for high-speed counters, refer to [Page 799 Special Register List](#).

## Precautions

### Count direction switch during measurement

The pulse density measurement mode calculates pulse density based on difference in measuring unit time of the current value of high-speed counters. You should therefore note that the input number of pulses may differ from the measurement value when count direction of a high-speed counter is switched within the same measuring unit time.

**Ex.**

When pulse density is measured, 14 pulses are input within measuring unit time, but the current value of the high-speed counter remains "0", as shown in the following figure. As a result, pulse density is "0" for this measuring unit time.

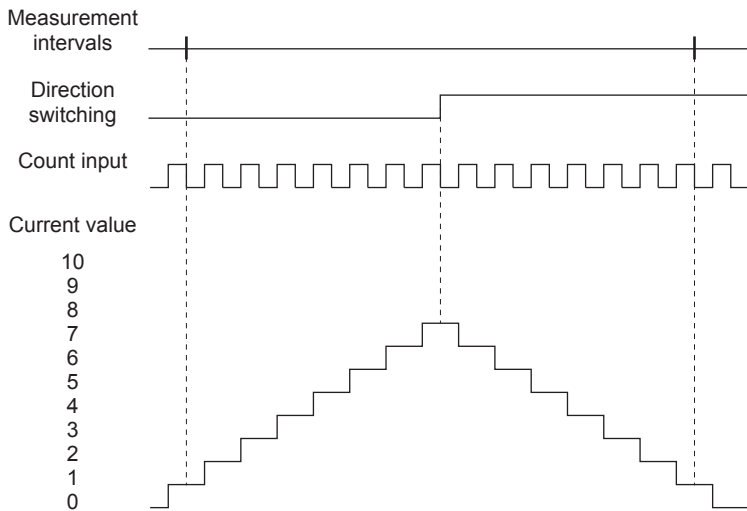

### ■ Operation when counting in the minus direction

Pulse density can also be measured when pulses are input in the direction whereby current value of high-speed counter is reduced.

### ■ Operation at overflow of high-speed counter current value

Pulse density measurement can continue even when current value of high-speed counter overflows during measurement.

### ■ Relationship with the SPD/DSPD instruction

If pulse density measurement has already been started by the HIOEN/DHIOEN instruction, the SPD/DSPD instruction cannot be used for the same channel.

If pulse density is currently being measured by the SPD/DSPD instruction, pulse density measurement cannot be started for the same channel.

For details on the SPD/DSPD instruction, refer to [MELSEC iQ-F FX5 Programming Manual \(Instructions, Standard Functions/Function Blocks\)](#).

### ■ Other precautions

There are common precautions when using high-speed counters. For details, refer to [Page 283 Precautions when using high-speed counters](#).

## High-speed counter (rotational speed measurement mode)

The rotational speed measurement mode for high-speed counters is explained below. The rotational speed measurement mode is not supported in high-speed pulse input/output modules.

When in rotational speed measurement mode, pulse is counted from count input of the high-speed counter, and the rotational speed for a specified amount of time is automatically calculated.

### Parameter setting

Set operation mode to rotational speed measurement mode by high-speed counter parameter setting.

Sets detailed settings for channel used.

Navigation window ⇒ [Parameter] ⇒ [Module model name] ⇒ [Module Parameter] ⇒ [High Speed I/O] ⇒ "Input Function" ⇒ "High Speed Counter" ⇒ "Detailed Setting" ⇒ "Basic Settings"

## Window

Item	CH1	CH2	CH3
<b>Use/Do Not Use Counter</b>	<b>Set whether to use counter or not.</b>		
Use/Not Use	Enable	Enable	Enable
<b>Operation Mode</b>	<b>Set operation mode.</b>		
Operation Mode	Rotation Speed Measurement Mode	Rotation Speed Measurement Mode	Rotation Speed Measurement Mode
<b>Pulse Input Mode</b>	<b>Set pulse input mode.</b>		
Pulse Input Mode	1-Phase 1 Input (S/W Up/Down Switch)	2 Phase 2 Multiple	2 Phase 4 Multiple
<b>Preset Input</b>	<b>Set preset input.</b>		
Preset Input Enable/Disable	Disable	Disable	Disable
Input logic	Positive Logic	Positive Logic	Positive Logic
Input Comparison Enable/Disable	Disable	Disable	Disable
Control Switch	Rising	Rising	Rising
<b>Preset Value</b>			
Preset Value	0	0	0
<b>Enable Input</b>	<b>Set enable input.</b>		
Enable Input Enable/Disable	Disable	Disable	Disable
Input logic	Positive Logic	Positive Logic	Positive Logic
<b>Ring Length Setting</b>	<b>Set ring length.</b>		
Ring Length Enable/Disable	Disable	Disable	Disable
Ring Length			
<b>Measurement Unit Time</b>	<b>Set the measurement unit time (ms) for the pulse density measurement mode and rotation speed measurement mode.</b>		
Measurement Unit Time	1000	3000	20000
<b>No. of Pulse per Rotation</b>	<b>Set the number of pulses per rotation when using the rotation speed measurement mode.</b>		
No. of Pulse per Rotation	1000	10000	15000

## Displayed items

Item	Description	Setting range	Default
Use/Not Use	Set whether use counter or not.	<ul style="list-style-type: none"> <li>Disable</li> <li>Enable</li> </ul>	Disable
Operation Mode	Set operation mode.	<ul style="list-style-type: none"> <li>Normal Mode</li> <li>Pulse Density Assumption Mode</li> <li>Rotation Speed Measurement Mode</li> </ul>	—
Pulse Input Mode	Set pulse input mode.	<ul style="list-style-type: none"> <li>1-Phase 1 Input (S/W Up/Down Switch)</li> <li>1-Phase 1 Input (H/W Up/Down Switch)</li> <li>1 Phase 2 Input</li> <li>2 Phase 1 Multiple</li> <li>2 Phase 2 Multiple</li> <li>2 Phase 4 Multiple</li> <li>Internal Clock (1MHz)</li> </ul>	—
Preset Input Enable/Disable	Not available for high-speed counters (rotational speed measurement mode).	—	—
Input logic			
Input Comparison Enable/Disable			
Control Switch			
Preset Value			
Enable Input Enable/Disable	Set whether to "enable" or "disable" the enable input.	<ul style="list-style-type: none"> <li>Disable</li> <li>Enable</li> </ul>	—
Input logic	Set the enable input logic value.	<ul style="list-style-type: none"> <li>Positive Logic</li> <li>Negative Logic</li> </ul>	—
Ring Length Enable/Disable	Not available for high-speed counters (rotational speed measurement mode).	—	—
Ring Length			
Measurement Unit Time	Set measurement unit time. (Unit: ms)	1 to 2147483647	—
No. of Pulse per Rotation	Set the No. of pulses per rotation. (Unit: pulse)	1 to 2147483647	—

Parameters are enabled when the CPU module is powered ON or after a reset. In addition, operations different from the parameter settings are possible by transferring values to special relays and special registers while changing these values in the program.

For details concerning special relays and special registers for high-speed counters, refer to [Page 772](#) Special Relay List, [Page 799](#) Special Register List.

## Rotational speed measurement mode start/stop

The rotational speed measurement mode cannot measure by setting the parameter alone.

The HIOEN/DHIOEN instruction is required to start/stop measurement.

For the HIOEN/DHIOEN instruction, refer to [MELSEC iQ-F FX5 Programming Manual \(Instructions, Standard Functions/Function Blocks\)](#).

## Rotational speed

Rotational speed is stored in the special register for each channel. (Unit: r/min)

For details concerning special registers for high-speed counters, refer to [Page 799](#) Special Register List.

### Precautions

#### ■Count direction switch during measurement

The rotational speed measurement mode calculates rotational speed based on current value difference of high-speed counters in the measuring unit time. You should therefore note that the input number of pulses may differ from the measurement value when count direction of a high-speed counter is switched within the same measuring unit time.

#### ■Operation when counting in the minus direction

Rotational speed can also be measured when pulses are input in the direction whereby current value of high-speed counter is reduced.

#### ■Operation at overflow of high-speed counter current value

Rotational speed measurement can continue even when current value of high-speed counter overflows during measurement.

#### ■Relationship with the SPD/DSPD instruction

If rotational speed measurement has already been started by the HIOEN/DHIOEN instruction, the SPD/DSPD instruction cannot be used for the same channel.

Inversely, if pulse density is currently being measured by the SPD/DSPD instruction, rotational speed measurement cannot be started for the same channel.

For details on the SPD/DSPD instruction, refer to [MELSEC iQ-F FX5 Programming Manual \(Instructions, Standard Functions/Function Blocks\)](#).

#### ■Other precautions

There are common precautions when using high-speed counters. For details, refer to [Page 283](#) Precautions when using high-speed counters.

# High-speed comparison table

The high-speed comparison table is explained below.

Used to set high-speed comparison table for high-speed counters.

## Parameter setting

Sets match output setting for high-speed counters.

### ■CPU module

Navigation window ⇒ [Parameter] ⇒ [Module model name] ⇒ [Module Parameter] ⇒ [High Speed I/O] ⇒ "Input Function" ⇒ "High Speed Counter" ⇒ "Detailed Setting" ⇒ "High Speed Compare Table"

## Window

NO.	Counter CH	Comparison Type	Output Destination Device	Comparison Value 1 Specification Method	Comparison Value 1 Direct	Comparison Value 1 Indirect	Comparison Value 2 Specification Method	Comparison Value 2 Direct	Comparison Value 2 Indirect
1	CH1	Set	Y0	Direct Specification	100		Direct Specification	0	
2	CH2	Set	Y1	Indirect Specification	0	D101	Direct Specification	0	
3	CH3	Band Area Comparis	Y2	Direct Specification	200		Direct Specification	300	
4	CH4	Band Area Comparis	Y3	Indirect Specification	0	D103	Indirect Specification	0	D105
5	Disable	Set		Direct Specification	0		Direct Specification	0	

## Displayed items

Item	Description	Setting range	Default
Counter CH	Set the counter CH of coincidence output target.	Disable, CH1 to CH8	Disable
Comparison Type	Set comparison type.	<ul style="list-style-type: none"> <li>Set</li> <li>Reset</li> <li>Self Reset</li> <li>Band Area Comparison</li> </ul>	Set
Output Destination Device	Sets output destination device for output comparison results of comparison value 1 and comparison value 2.	Bit device (Y, M), Interrupt pointer (I16 to I23)	—
Comparison Value 1 Specification Method	Sets the specification method of comparison value 1.	<ul style="list-style-type: none"> <li>Direct Specification</li> <li>Indirect Specification</li> </ul>	Direct Specification
Comparison Value 1 Direct	Sets value (comparison value 1) to be compared with current value of high-speed counter. (When direct specification is selected)	$-2147483648 \leq \text{Comparison value} \leq 2147483647$	0
Comparison Value 1 Indirect	Sets device (comparison value 1) to be compared with current value of high-speed counter. (When indirect specification is selected)	Word device (D, R)	—
Comparison Value 2 Specification Method	If band comparison is set to comparison type, sets the specification method of comparison value 2.	<ul style="list-style-type: none"> <li>Direct Specification</li> <li>Indirect Specification</li> </ul>	—
Comparison Value 2 Direct	If band comparison is set to comparison type, sets value (comparison value 2) to be compared with current value of high-speed counter. (When direct specification is selected)	$\text{Comparison value 1} \leq \text{Comparison value 2} \leq 2147483647$	—
Comparison Value 2 Indirect	If band comparison is set to comparison type, sets device (comparison value 2) to be compared with current value of high-speed counter. (When indirect specification is selected)	Word device (D, R)	—

### ■High-speed pulse input/output module

Add the high-speed pulse input/output module.

Navigation window ⇒ [Parameter] ⇒ [Module Information] ⇒ Right-click ⇒ Add New Module

After adding the high-speed pulse input/output module, make settings on the screen displayed from the following operation.

Navigation window ⇒ [Parameter] ⇒ [Module Information] ⇒ [1 to 16 (high-speed pulse input/output module)] ⇒ [Module Parameter] ⇒ "Input Function" ⇒ "High Speed Counter" ⇒ "Detailed Setting" ⇒ "High Speed Compare Table"



## Window

NO.	Counter CH	Comparison Type	Output Destination Device	Comparison Value 1 Specification Method	Comparison Value 1 Direct	Comparison Value 1 Indirect
1	CH+0(CH9)	Set	Y0	Direct Specification	100	
2	CH+1(CH10)	Reset	Y1	Indirect Specification	0	D100
3	Disable	Set		Direct Specification	0	

Shown above is the screen at the time when the first high-speed pulse input/output module is selected.

26

## Displayed items

Item	Description	Setting range	Default
Counter CH	Set the counter CH of coincidence output target.	Disable, CH+0(CH□),CH+1(CH□+1)*1	Disable
Comparison Type	Set comparison type.	<ul style="list-style-type: none"> <li>Set</li> <li>Reset</li> <li>Self Reset</li> </ul>	Set
Output Destination Device	Sets output destination device for output comparison results of comparison value 1 and comparison value 2.	Bit device (Y, M), Interrupt pointer (I50 to I177)	—
Comparison Value 1 Specification Method	Sets the specification method of comparison value 1.	<ul style="list-style-type: none"> <li>Direct Specification</li> <li>Indirect Specification</li> </ul>	Direct Specification
Comparison Value 1 Direct	Sets value (comparison value 1) to be compared with current value of high-speed counter. (When direct specification is selected)	$-2147483648 \leq \text{Comparison value} \leq 2147483647$	0
Comparison Value 1 Indirect	Sets device (comparison value 1) to be compared with current value of high-speed counter. (When indirect specification is selected)	Word device (D, R)	—

\*1 The number in □ is first module: 9, second module: 11, third module: 13, fourth module: 15.

### Point

- You can create an open table entry before table setting is complete.
- Table settings can be made in any order. Be careful when the current value is changed by self-reset at a table along the way, as table processing starts with the first table then the following tables in order.

## High-speed comparison table operation

Operation of each type of high-speed comparison table operation is explained below.

### ■Set to ON

When comparison value 1 matches the current value of the set high-speed counter, the bit device specified as the output destination device is set. If interrupt pointer has been specified for output destination device, the interrupt program of the specified interrupt pointer is run simultaneously when it matches comparison value 1.

Operation is the same as for the DHSCS instruction. For information on the DHSCS instruction, refer to [MELSEC iQ-F FX5 Programming Manual \(Instructions, Standard Functions/Function Blocks\)](#).

### ■Reset

When comparison value 1 matches the current value of the set high-speed counter, the bit device specified as the output destination device is reset.

Operation is the same as for the DHSCR instruction. For information on the DHSCR instruction, refer to [MELSEC iQ-F FX5 Programming Manual \(Instructions, Standard Functions/Function Blocks\)](#).

### ■Self-reset

When comparison value 1 matches the current value of the set high-speed counter, the current value becomes the preset value. After comparison processing is executed for this table, comparison processing of this high speed counter in later tables is performed using the preset value.

Operation is the same as self-reset for the DHSCR instruction. For information on the DHSCR instruction, refer to [MELSEC iQ-F FX5 Programming Manual \(Instructions, Standard Functions/Function Blocks\)](#).

## ■Zone Compare

Based on the current high-speed counter value, comparison value 1, and comparison value 2, one of the three output devices from the head output device will be set. The rest are reset. High-speed pulse input/output module is not supported.

	Set
Comparison value 1 > Current value	→ Head output device
Comparison value 1 ≤ Current value ≤ Comparison value 2	→ Head output device +1
Current value > Comparison value 2	→ Head output device +2

Operation is the same as for the DHSZ instruction. For information on zone comparison and DHSZ instruction, refer to  MELSEC iQ-F FX5 Programming Manual (Instructions, Standard Functions/Function Blocks).

## Comparison start/stop for high-speed comparison table

High-speed comparison tables cannot execute comparison by setting the parameter alone.

The HIOEN/DHIOEN instruction is required to start/stop the high-speed comparison table.

For the HIOEN/DHIOEN instruction, refer to  MELSEC iQ-F FX5 Programming Manual (Instructions, Standard Functions/Function Blocks).

### Point

The HIOEN/DHIOEN instruction is required to start/stop high-speed counters as well when using a high-speed comparison table.

Measurement is not conducted by starting the high-speed comparison table alone, and the high-speed comparison table therefore does not operate.

When the number of the high-speed comparison table that is executed is number 17 or higher, use the DHIOEN instruction.

## Precautions

### ■Number of tables that can be set

Up to 32 tables for the CPU module and up to 15 tables for the high-speed pulse input/output module can be set. Empty tables are not included in the number of tables.

However, number of tables that can be set differs depending on the version. ( Page 966 Added and Enhanced Functions)

### ■Processing order

High-speed comparison tables are processed in sequence starting from the first table.

### ■Operation start timing

High-speed comparison tables are updated during END processing. If started/stopped by the HIOEN/DHIOEN instruction, the table is applied starting from the next scan. Caution must be exercised when controlling high-speed comparison tables using the HIOEN/DHIOEN instruction several times within the same scan.

#### Ex.

Table operation is as follows when multiple HIOEN/DHIOEN instructions are executed within the same scan.

Tables 1, 2 and 4 are started at the 1st HIOEN/DHIOEN instruction.

Tables 3 and 5 are started, and 2 and 4 are stopped at the 2nd HIOEN/DHIOEN instruction.

Table 2 is started and 5 is stopped at the 3rd HIOEN/DHIOEN instruction.

Tables 1, 2 and 3 operate.

### ■Operation when using internal clock

Self-reset cannot be used for channels set to internal clock by pulse input mode.

### ■Other precautions

There are common precautions when using high-speed counters. For details, refer to  Page 283 Precautions when using high-speed counters.

## Multiple point output, high-speed comparison tables

Multiple point output, high-speed comparison tables are explained below. The multiple point output, high-speed comparison tables is not supported in high-speed pulse input/output modules.

Use to set multiple point output, high-speed comparison tables for high-speed counters.

### Parameter setting

Sets match output table comparison setting for high-speed counters.

Navigation window ⇒ [Parameter] ⇒ [Module model name] ⇒ [Module Parameter] ⇒ [High Speed I/O] ⇒ "Input Function" ⇒ "High Speed Counter" ⇒ "Detailed Setting" ⇒ "Multi-point Output High Speed Compare Table"

### Window

Table Data	Use Device	Counter CH	CH1
Output Data	Bit Output	Points	1

NO.	Enable/Disable	Device	Comparison Value	Output Device	Output Data (HEX)
1	Enable	D100	100 Y0		1
2	Enable	D104	200 Y0		0
3	Disable	D108	0 Y0		

### Displayed items

Item	Description	Setting range	Default
Table Data	Sets whether or not to use user device for table data.	<ul style="list-style-type: none"> <li>Do Not Use Device</li> <li>Use Device</li> </ul>	Do Not Use Device
Counter CH	Set Comparison Target CH.	CH1 to CH8	CH1
Output Data	Sets the type of output data.	<ul style="list-style-type: none"> <li>Bit Output</li> <li>Word Output</li> </ul>	Bit Output
Points	Sets the number of output data points.	<ul style="list-style-type: none"> <li>Bit Output 1 to 16</li> <li>Word Output 1 to 2</li> </ul>	1
Enable/Disable	Sets whether to "enable" or "disable" table data.	<ul style="list-style-type: none"> <li>Disable</li> <li>Enable</li> </ul>	Disable
Device	Set the device used for table data.	Word device (D, R)	—
Comparison Value	Sets value (comparison value) to be compared with current value of high-speed counter.	$-2147483648 \leq \text{Comparison value} \leq +2147483647$	—
Output Device	Sets the output destination device of output data.	<ul style="list-style-type: none"> <li>Bit Output Y, M</li> <li>Word Output D, R</li> </ul>	—
Output Data (HEX)	Sets output data.	According to output device	—

### Point

- When using user devices, you can change comparison value or output data while the program is running.
- When using user devices, each table occupies 4 devices. Word devices are used in order starting from the initial device.

## Multiple point output, high-speed comparison table operation

Operation of each type high-speed comparison table is explained below.

### ■Bit output

When comparison value 1 matches the current value of the set high-speed counter, output data is transferred to the output devices.

**Ex.**

Bit output, initial output device: Y0, Output points: 16

Table number	Comparison value	Output data
Table 1	10	H0001
Table 2	13	HAAAA
Table 3	19	H0100

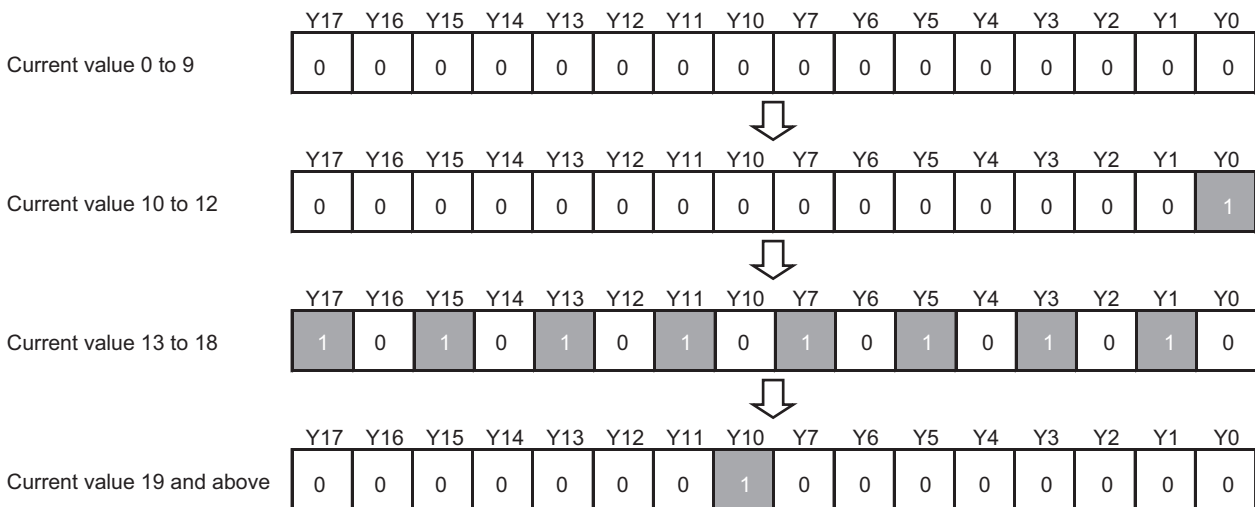

### ■Word output

When comparison value 1 matches the current value of the set high-speed counter, output data is transferred to the output devices.

**Ex.**

Word output, initial output device: D0, Output points: 1

Table number	Comparison value	Output data
Table 1	10	K100
Table 2	13	K300
Table 3	19	K10

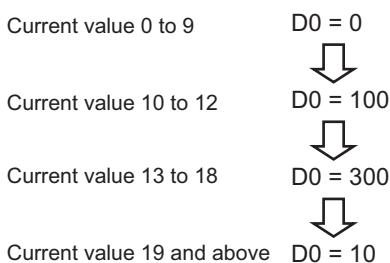

## Comparison start/stop for multiple point output, high-speed comparison table

Multiple point output, high-speed comparison tables cannot execute comparison by setting the parameter alone. The HIOEN/DHIOEN instruction is required to start/stop multiple point output, high-speed comparison tables. For the HIOEN/DHIOEN instruction, refer to  MELSEC iQ-F FX5 Programming Manual (Instructions, Standard Functions/Function Blocks).

### Point

The HIOEN/DHIOEN instruction is required to start/stop high-speed counters as well when using a multiple point output, high-speed comparison table. Measurement is not conducted by starting the multiple point output, high-speed comparison table alone, and the high-speed comparison table therefore does not operate.

## Precautions

### ■Setting number

Up to 128 tables can be set.

### ■Device value when using user device

Parameters and user devices are handled as follows when using user devices.

#### Ex.

If D0 is set to initial device

Table number	User device	
	Comparison value	Output data
Table 1	D1, D0	D3, D2
Table 2	D5, D4	D7, D6
Table 3	D9, D8	D11, D10
Table 4	D13, D12	D15, D14
Table 5	D17, D16	D19, D18

### ■When final table comparison is complete

When comparison processing has been completed up to the last set table, SM5001 turns ON. The high-speed counter current value is not cleared.

### ■Operation start timing

Multiple point output, high-speed comparison tables are enabled as soon as the HIOEN/DHIOEN instruction is executed.

### ■Table operation interval

The comparison value or input frequency must be set so the comparison value and high-speed counter current value match at intervals of following value.

- FX5S/FX5UJ CPU module: 200 $\mu$ s or more for each table
- FX5U/FX5UC CPU module: 100 $\mu$ s or more for each table

### ■Processing order

Multiple point output, high-speed comparison tables are processed in sequence starting from the first table. Only 1 table per count is processed.

### ■Table setting value update timing

When using user devices, you can change the table setting values by modifying the values of the device. However, the comparison value and output data values of the table currently being compared and the next table cannot be changed. If you modify the comparison values or output data, you can modify data of the next table in the sequence and those subsequent. The table number of which the table is being currently compared can be checked in the special register (SD5000).

### ■Other precautions

There are common precautions when using high-speed counters. For details, refer to  Page 283 Precautions when using high-speed counters.

# High-speed comparison match starts

Use the high-speed counter function and external start signal (☞ Page 383 External Start Signal) to start positioning operation when the specified number of inputs is detected. Examples of the wiring and parameter setting that start positioning operation when the input is detected 100 times are shown below.

For details on the high-speed counter function, refer to the following.

☞ Page 232 High-speed Counter Function

## System configuration example

The wiring when the FX5U CPU module (transistor) is used is shown below. For the other wiring, refer to connection examples of each servo amplifier.

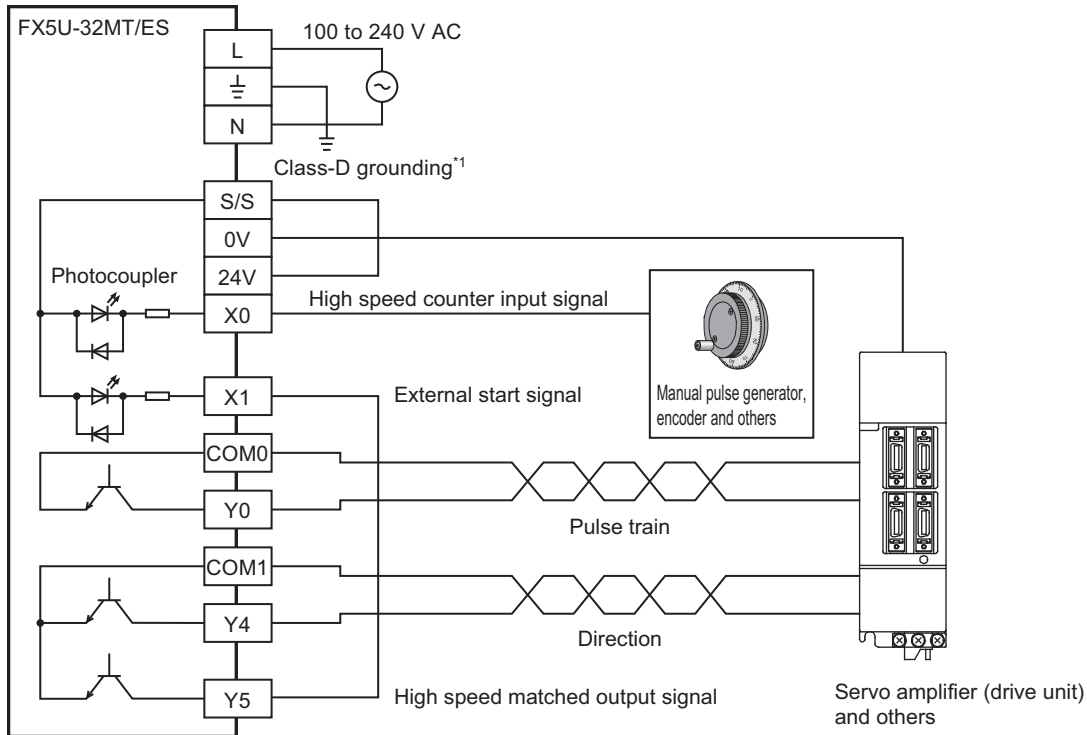

\*1 Be sure to use the class-D grounding method (grounding resistance: 100 Ω or less).

## Parameter setting example

Set the high speed I/O setting to the following parameter in GX Works3. A parameter that is not described here does not need to be set.

### High-speed counter

☞ [Navigation window] ⇒ [Parameter] ⇒ Module model name ⇒ [Module Parameter] ⇒ [High Speed I/O] ⇒ [Input Function] ⇒ [High Speed Counter] ⇒ [Detailed Setting] ⇒ [Basic Settings]

Item	CH1
<input type="checkbox"/> Use/Do Not Use Counter	<b>Set whether to use counter or not.</b>
Use/Not Use	Enable
<input type="checkbox"/> Operation Mode	<b>Set operation mode.</b>
Operation Mode	Normal Mode
<input type="checkbox"/> Pulse Input Mode	<b>Set pulse input mode.</b>
Pulse Input Mode	1-Phase 1 Input (S/W Up/Down Switch)

Set the CH1 parameter as follows.

Use/Do Not Use Counter	Operation Mode	Pulse Input Mode
Use	Normal Mode	1-Phase 1 Input (S/W Up/Down Switch)

## High-speed comparison table

[Navigation window] ⇒ [Parameter] ⇒ Module model name ⇒ [Module Parameter] ⇒ [High Speed I/O] ⇒ [Input Function] ⇒ [High Speed Counter] ⇒ [Detailed Setting] ⇒ [High Speed Compare Table]

NO.	Counter CH	Comparison Type	Output Destination Device	Comparison Value 1 Specification Method	Comparison Value 1 Direct
1	CH1	Set	Y5	Direct Specification	100

Set the No.1 parameter as follows.

Counter CH	Comparison Type	Output Destination Device	Comparison Value 1 Specification Method	Comparison Value 1 Direct
CH1	Set	Y5	Direct Specification	100

## Positioning

[Navigation window] ⇒ [Parameter] ⇒ Module model name ⇒ [Module Parameter] ⇒ [High Speed I/O] ⇒ [Output Function] ⇒ [Positioning] ⇒ [Detailed Setting] ⇒ [Basic Settings]

Item	Axis 1
<input type="checkbox"/> <b>Basic Parameter 1</b>	<b>Set basic parameter 1.</b>
Pulse Output Mode	1:PULSE/SIGN
Output Device (PULSE/CW)	Y0
Output Device (SIGN/CCW)	Y4
Rotation Direction Setting	0: Current Address Increment with Forward Run Pulse Output
Unit Setting	0: Motor System (pulse, pps)
No. of Pulse per Rotation	2000 pulse
Movement Amount per Rotation	1000 pulse
Position Data Magnification	1: X Single
<input checked="" type="checkbox"/> <b>Basic Parameter 2</b>	<b>Set basic parameter 2.</b>
<input type="checkbox"/> <b>Detailed Setting Parameter</b>	<b>Set the detailed setting parameter.</b>
External Start Signal Enable/Disable	1: Valid
External Start Signal Device No.	X1
External Start Signal Logic	0: Positive Logic

Set the axis 1 parameter as follows.

Basic Parameter 1			Detailed Setting Parameter		
Pulse Output Mode	Output Device (PULSE/CW)	Output Device (SIGN/CCW)	External Start Signal Enable/Disable	External Start Signal Device No.	External Start Signal Logic
1: PULSE/SIGN	Y0	Y4	1: Enabled	X1	0: Positive Logic

## Operation example

Wire and set the parameter setting following this example to perform the following positioning operation (high-speed comparison match start).

1. The drive contact of the positioning instruction for axis 1 turns on. (External start signal standby)
2. When the high-speed counter input (X0) of channel 1 is detected 100 times, the high-speed counter match output Y5 turns on.
3. When Y5 turns on, the external start signal X1 turns on.
4. Positioning operation of axis 1 starts after the external start signal is detected.

## Special relay details

Details concerning special relays used for high-speed counters are explained below.

### High-speed counter operating

Device for monitoring operation status of each channel of the high-speed counter.

#### ■Corresponding devices

The device numbers corresponding to each channel are as follows.

CPU module							
CH1	CH2	CH3	CH4	CH5	CH6	CH7	CH8
SM4500	SM4501	SM4502	SM4503	SM4504	SM4505	SM4506	SM4507

High-speed pulse input/output module							
First module		Second module		Third module		Fourth module	
CH9	CH10	CH11	CH12	CH13	CH14	CH15	CH16
SM4508	SM4509	SM4510	SM4511	SM4512	SM4513	SM4514	SM4515

#### ■Operation description

The content of the operation when ON and when OFF is as follows.

Operation when ON	Operation when OFF
High-speed counter operating	High-speed counter stopped



These devices also operate when the FX3 compatible high-speed counter function is valid.

#### ■Update timing

The timing of device update is as follows.

ON	OFF
<ul style="list-style-type: none"> <li>High-speed counter driven by the HIOEN/DHIOEN instruction</li> <li>SPD/DSPD instruction ON execution</li> <li>UDCNTF instruction is executed ON (when the FX3 compatible high-speed counter function is valid)</li> </ul>	<ul style="list-style-type: none"> <li>High-speed counter stopped by the HIOEN/DHIOEN instruction</li> <li>Power ON, reset, STOP, PAUSE</li> <li>UDCNTF instruction is executed OFF (when the FX3 compatible high-speed counter function is valid)</li> </ul>

### High-speed counter pulse density/rotational speed being measured

Device for monitoring operation of the high-speed counter when using pulse density/rotational speed measurement mode.

#### ■Corresponding devices

The device numbers corresponding to each channel are as follows.

CH1	CH2	CH3	CH4	CH5	CH6	CH7	CH8
SM4516	SM4517	SM4518	SM4519	SM4520	SM4521	SM4522	SM4523

#### ■Operation description

The content of the operation when ON and when OFF is as follows.

Operation when ON	Operation when OFF
Pulse density/rotational speed measurement mode operating Updates measurement results by measuring unit time.	Pulse density/rotational speed measurement mode stopped or not being used



If the FX3 compatible high-speed counter function is valid, these devices operate only when the SPD/DSPD instruction operates.



## Update timing

The timing of device update is as follows.

ON	OFF
<ul style="list-style-type: none"> <li>Pulse density/rotational speed measurement mode is set in parameter and pulse density/rotational speed measurement is driven by the HIOEN/DHIOEN instruction.</li> <li>SPD/DSPD instruction ON execution</li> </ul>	<ul style="list-style-type: none"> <li>Pulse density/rotational speed measurement mode is set in parameter and pulse density/rotational speed measurement is stopped by the HIOEN/DHIOEN instruction.</li> <li>SPD/DSPD instruction OFF execution</li> <li>Power ON, reset, STOP, PAUSE</li> </ul>

## High-speed counter overflow

Flag that detects counter value overflow of high-speed counter.

### Corresponding devices

The device numbers corresponding to each channel are as follows.

CPU module							
CH1	CH2	CH3	CH4	CH5	CH6	CH7	CH8
SM4532	SM4533	SM4534	SM4535	SM4536	SM4537	SM4538	SM4539

High-speed pulse input/output module							
First module		Second module		Third module		Fourth module	
CH9	CH10	CH11	CH12	CH13	CH14	CH15	CH16
SM4540	SM4541	SM4542	SM4543	SM4544	SM4545	SM4546	SM4547

### Operation description

The content of the operation when ON and when OFF is as follows.

Operation when ON	Operation when OFF
Overflow occurs (Current value counted = +1 past maximum positive value)	Overflow does not occur

#### Point

- Does not operate when ring length setting is enabled.
- These devices also operate when the FX3 compatible high-speed counter function is valid.

## Update timing

The timing of device update is as follows.

ON	OFF
<ul style="list-style-type: none"> <li>Overflow occurs (This is updated with the END processing. When the FX3 compatible high-speed counter function is valid, the updating is made also when instruction UDCNTF instruction is executed ON.)</li> </ul>	<ul style="list-style-type: none"> <li>When OFF by the user</li> <li>Power ON, reset</li> <li>STOP/PAUSE→RUN</li> <li>SM50 turned ON</li> </ul>

## High-speed counter underflow

Flag that detects counter value underflow of high-speed counter.

### Corresponding devices

The device numbers corresponding to each channel are as follows.

CPU module							
CH1	CH2	CH3	CH4	CH5	CH6	CH7	CH8
SM4548	SM4549	SM4550	SM4551	SM4552	SM4553	SM4554	SM4555

High-speed pulse input/output module							
First module		Second module		Third module		Fourth module	
CH9	CH10	CH11	CH12	CH13	CH14	CH15	CH16
SM4556	SM4557	SM4558	SM4559	SM4560	SM4561	SM4562	SM4563

## ■Operation description

The content of the operation when ON and when OFF is as follows.

Operation when ON	Operation when OFF
Underflow occurs (Current value counted = -1 past maximum negative value)	Underflow does not occur

### Point

- Does not operate when ring length setting is enabled.
- These devices also operate when the FX3 compatible high-speed counter function is valid.

## ■Update timing

The timing of device update is as follows.

ON	OFF
<ul style="list-style-type: none"> <li>• Underflow occurs (This is updated with the END processing. When the FX3 compatible high-speed counter function is valid, the updating is made also when UDCNTF instruction is executed ON.)</li> </ul>	<ul style="list-style-type: none"> <li>• When OFF by the user</li> <li>• Power ON, reset</li> <li>• STOP/PAUSE→RUN</li> <li>• SM50 turned ON</li> </ul>

## High-speed counter count direction monitor

Device for monitoring counter direction.

### ■Corresponding devices

The device numbers corresponding to each channel are as follows.

CPU module							
CH1	CH2	CH3	CH4	CH5	CH6	CH7	CH8
SM4564	SM4565	SM4566	SM4567	SM4568	SM4569	SM4570	SM4571

High-speed pulse input/output module							
First module		Second module		Third module		Fourth module	
CH9	CH10	CH11	CH12	CH13	CH14	CH15	CH16
SM4572	SM4573	SM4574	SM4575	SM4576	SM4577	SM4578	SM4579

## ■Operation description

The content of the operation when ON and when OFF is as follows.

Operation when ON	Operation when OFF
High-speed counter counting in direction whereby current value is reduced (Down-counting)	High-speed counter counting in direction whereby current value is increased (Up-counting)

### Point

These devices also operate when the FX3 compatible high-speed counter function is valid.

## ■Update timing

The timing of device update is as follows.

ON	OFF
<ul style="list-style-type: none"> <li>• Down-counting (This is updated with the END processing. When the FX3 compatible high-speed counter function is valid, the updating is made also when UDCNTF instruction is executed ON.)</li> </ul>	<ul style="list-style-type: none"> <li>• Up-counting (This is updated with the END processing. When the FX3 compatible high-speed counter function is valid, the updating is made also when UDCNTF instruction is executed ON.)</li> <li>• Power ON, reset</li> <li>• STOP/PAUSE→RUN</li> </ul>

## High-speed counter (1-phase 1-input S/W) (internal clock) count direction switch

Device for switching counter direction when using 1-phase 1-input (S/W) counter or internal clock.

### ■Corresponding devices

The device numbers corresponding to each channel are as follows.

CPU module							
CH1	CH2	CH3	CH4	CH5	CH6	CH7	CH8
SM4580	SM4581	SM4582	SM4583	SM4584	SM4585	SM4586	SM4587

High-speed pulse input/output module							
First module		Second module		Third module		Fourth module	
CH9	CH10	CH11	CH12	CH13	CH14	CH15	CH16
SM4588	SM4589	SM4590	SM4591	SM4592	SM4593	SM4594	SM4595

### ■Operation description

The content of the operation when ON and when OFF is as follows.

Operation when ON	Operation when OFF
High-speed counter current value counted -1 when input A phase ON	High-speed counter current value counted +1 when input A phase ON

#### Point

- Setting is ignored for counter other than 1-phase 1-input (S/W), internal clock.
- These devices also operate when the FX3 compatible high-speed counter function is valid.

### ■Update timing

The timing of device update is as follows.

ON	OFF
When ON by the user (update by END processing)	<ul style="list-style-type: none"> <li>• When OFF by the user (update by END processing)</li> <li>• Power ON, reset</li> <li>• STOP/PAUSE→RUN</li> </ul>

#### Point

Can also be modified while the high-speed counter is operating.

## High-speed counter preset input logic

These devices are used for setting the preset input logic.

### ■Corresponding devices

The device numbers corresponding to each channel are as follows.

CPU module							
CH1	CH2	CH3	CH4	CH5	CH6	CH7	CH8
SM4596	SM4597	SM4598	SM4599	SM4600	SM4601	SM4602	SM4603

High-speed pulse input/output module							
First module		Second module		Third module		Fourth module	
CH9	CH10	CH11	CH12	CH13	CH14	CH15	CH16
SM4604	SM4605	SM4606	SM4607	SM4608	SM4609	SM4610	SM4611

## ■ Operation description

The content of the operation when ON and when OFF is as follows.

Operation when ON	Operation when OFF
The preset input operates with negative logic	The preset input operates with positive logic

### Point

- The timing to execute the preset is determined by the preset input logic and the preset control switch.
- These devices also operate when the FX3 compatible high-speed counter function is valid.

## ■ Update timing

The timing of device update is as follows.

ON	OFF
<ul style="list-style-type: none"> <li>• When ON by the user</li> <li>• When set to negative logic with parameters</li> </ul>	<ul style="list-style-type: none"> <li>• When OFF by the user</li> <li>• When set to positive logic with parameters</li> </ul>

### Point

Cannot be modified while the high-speed counter is operating. Operates in the configured status when the high-speed counter starts.

## High-speed counter preset input comparison

These devices are used to specify whether or not to perform a comparison with the preset value when there is preset input.

## ■ Corresponding devices

The device numbers corresponding to each channel are as follows.

CPU module							
CH1	CH2	CH3	CH4	CH5	CH6	CH7	CH8
SM4612	SM4613	SM4614	SM4615	SM4616	SM4617	SM4618	SM4619

High-speed pulse input/output module							
First module		Second module		Third module		Fourth module	
CH9	CH10	CH11	CH12	CH13	CH14	CH15	CH16
SM4620	SM4621	SM4622	SM4623	SM4624	SM4625	SM4626	SM4627

## ■ Operation description

The content of the operation when ON and when OFF is as follows.

Operation when ON	Operation when OFF
Execute comparison processing with the preset value when there is preset input	Do not execute comparison processing when there is preset input

### Point

These devices also operate when the FX3 compatible high-speed counter function is valid.

## ■ Update timing

The timing of device update is as follows.

ON	OFF
<ul style="list-style-type: none"> <li>• When ON by the user</li> <li>• When set to enabled with parameters</li> </ul>	<ul style="list-style-type: none"> <li>• When OFF by the user</li> <li>• When set to disabled with parameters</li> </ul>

### Point

- Cannot be modified while the high-speed counter is operating. Operates in the configured status when the high-speed counter starts.
- When the current value of a high-speed counter is rewritten with the HCMOV/DHCMOV instruction, the comparison process is not executed.
- When the preset control switch is set to "Constant when ON", the preset input comparison is disabled.

## High-speed counter enable input logic

These devices are used for setting the enable input logic.

### ■Corresponding devices

The device numbers corresponding to each channel are as follows.

CPU module							
CH1	CH2	CH3	CH4	CH5	CH6	CH7	CH8
SM4628	SM4629	SM4630	SM4631	SM4632	SM4633	SM4634	SM4635

High-speed pulse input/output module							
First module		Second module		Third module		Fourth module	
CH9	CH10	CH11	CH12	CH13	CH14	CH15	CH16
SM4636	SM4637	SM4638	SM4639	SM4640	SM4641	SM4642	SM4643

### ■Operation description

The content of the operation when ON and when OFF is as follows.

Operation when ON	Operation when OFF
The enable input operates with negative logic (Enabled when the enable input is OFF)	The enable input operates with positive logic (Enabled when the enable input is ON)



These devices also operate when the FX3 compatible high-speed counter function is valid.

### ■Update timing

The timing of device update is as follows.

ON	OFF
<ul style="list-style-type: none"> <li>• When ON by the user</li> <li>• When set to negative logic with parameters</li> </ul>	<ul style="list-style-type: none"> <li>• When OFF by the user</li> <li>• When set to positive logic with parameters</li> </ul>



Cannot be modified while the high-speed counter is operating. Operates in the configured status when the high-speed counter starts.

## High-speed counter ring length setting

These devices enable or disable the ring length setting for ring counters.

### ■Corresponding devices

The device numbers corresponding to each channel are as follows.

CPU module							
CH1	CH2	CH3	CH4	CH5	CH6	CH7	CH8
SM4644	SM4645	SM4646	SM4647	SM4648	SM4649	SM4650	SM4651

High-speed pulse input/output module							
First module		Second module		Third module		Fourth module	
CH9	CH10	CH11	CH12	CH13	CH14	CH15	CH16
SM4652	SM4653	SM4654	SM4655	SM4656	SM4657	SM4658	SM4659

## ■ Operation description

The content of the operation when ON and when OFF is as follows.

Operation when ON	Operation when OFF
Enables the ring length setting for a ring counter (Counts in the range of 0 to ring length counter-1)	Disables the ring length setting for a ring counter (Counts in the range of -2147483648 to +2147483647)

### Point

These devices do not operate when the FX3 compatible high-speed counter function is valid.

## ■ Update timing

The timing of device update is as follows.

ON	OFF
<ul style="list-style-type: none"> <li>When ON by the user</li> <li>When set to enabled with parameters</li> </ul>	<ul style="list-style-type: none"> <li>When OFF by the user</li> <li>When set to disabled with parameters</li> </ul>

### Point

- Cannot be modified while the high-speed counter is operating. Operates in the configured status when the high-speed counter starts.
- The ring length setting is disabled if the pulse density measurement mode or rotational speed measurement mode is selected.

## Precautions

If these devices are turned on when a high-speed counter's current value is out of the ring length range, the current value when the high-speed counter is operated is as follows.

- Lower than lower limit value → Lower limit value
- Higher than upper limit value → Upper limit value

## High-speed comparison table (high-speed compare instruction) operation

This device is for monitoring the operational status of the high-speed counter's high-speed comparison table and the high-speed comparison instruction.

### ■ Corresponding devices

The device numbers corresponding to each channel are as follows.

CPU module								High-speed pulse input/output module							
								First module		Second module		Third module		Fourth module	
CH1	CH2	CH3	CH4	CH5	CH6	CH7	CH8	CH9	CH10	CH11	CH12	CH13	CH14	CH15	CH16
SM4980								SM4984		SM4988		SM4992		SM4996	

## ■ Operation description

The content of the operation when ON and when OFF is as follows.

Operation when ON	Operation when OFF
High-speed comparison table operating When the high-speed counter current value and the high-speed comparison table set value or the DHSCS, DHSCR, DHSZ instruction set value are equal, the specified bit device is set or reset.	High-speed comparison table stopped Even when the high-speed counter current value and the high-speed comparison table set value or the DHSCS, DHSCR, DHSZ instruction set value are equal, the specified bit device does not change.

### Point

These devices also operate when the FX3 compatible high-speed counter function is valid.

## ■Update timing

The timing of device update is as follows.

ON	OFF
<ul style="list-style-type: none"> <li>Match output driven by the DHIOEN instruction</li> <li>ON execution by DHSCS, DHSCR, DHSZ instruction</li> </ul>	<ul style="list-style-type: none"> <li>Match output stopped by the DHIOEN instruction and DHSCS, DHSCR, DHSZ instructions all OFF</li> <li>Power ON, reset, STOP, PAUSE</li> </ul>

## High-speed comparison table (high-speed compare instruction) error occurrence

This device turns ON when driving the DHSCS, DHSCR, and DHSZ instructions in excess of the limitation of the number of instructions driven at the same time or driving the high-speed comparison table in excess of the limitation of the number of the tables starting at the same time.

## ■Corresponding devices

The device numbers corresponding to each channel are as follows.



CPU module								High-speed pulse input/output module							
								First module		Second module		Third module		Fourth module	
CH1	CH2	CH3	CH4	CH5	CH6	CH7	CH8	CH9	CH10	CH11	CH12	CH13	CH14	CH15	CH16
SM4982								SM4986		SM4990		SM4994		SM4998	

## ■Operation description

The content of the operation when ON and when OFF is as follows.

Operation when ON	Operation when OFF
<ul style="list-style-type: none"> <li>DHSCS, DHSCR, DHSZ instructions operated in excess of the limitation of the number of instructions driven at the same time.</li> <li>An operation was made in excess of the limit of number of tables of the high speed comparison table starting at the same time.</li> </ul>	When there is no error DHSCS, DHSCR, DHSZ instructions, and high-speed comparison table can operate

### Point

- Even when this device turns on, if the operation setting of the CPU module operation upon error detection setting (  Page 128 CPU module operation upon error detection setting) is "Continue", the DHSCS, DHSCR, DHSZ instructions within the range of the number of instructions driven at the same time will operate. For the limitation of the number of instructions driven at the same time, refer to  Page 283 Precautions when using high-speed counters.
- These devices also operate when the FX3 compatible high-speed counter function is valid.

## ■Update timing

The timing of device update is as follows.

ON	OFF
<ul style="list-style-type: none"> <li>Updated in END processing</li> <li>If an error occurs while the FX3 compatible DHSCS, DHSCR, and DHSZ instruction ON execution, an operation is made also when the high-speed counter function is valid.</li> </ul>	<ul style="list-style-type: none"> <li>When OFF by the user</li> <li>Power ON, reset</li> </ul>

## Multi-point output high-speed comparison table operation

This device is for monitoring the operational status of the high-speed counter's multi-point output high-speed comparison tables.

## ■Corresponding devices

The device number is shared for all channels of the CPU module.

CH1	CH2	CH3	CH4	CH5	CH6	CH7	CH8
SM5000							

## ■ Operation description

The content of the operation when ON and when OFF is as follows.

Operation when ON	Operation when OFF
Multi-point output high-speed comparison table operating When the high-speed counter current value is equal to the set value specified in the multi-point output high-speed comparison table parameters, the specified pattern of output or the data transfer operates.	Multi-point output high-speed comparison tables stopped Even when the high-speed counter current value is equal to the set value specified in the multi-point output high-speed comparison table parameters, the specified pattern of output or the data transfer is not executed.



These devices also operate when the FX3 compatible high-speed counter function is valid.

## ■ Update timing

The timing of device update is as follows.

ON	OFF
<ul style="list-style-type: none"> <li>Match output driven by the HIOEN/DHIOEN instruction</li> <li>ON execution by DHSCS, DHSCR, DHSZ instruction</li> </ul>	<ul style="list-style-type: none"> <li>Match output stopped by the HIOEN/DHIOEN instruction and DHSCS, DHSCR, DHSZ instructions all OFF</li> <li>Power ON, reset, STOP, PAUSE</li> <li>SM8034 turned ON</li> </ul>

## Multi-point output high-speed comparison table completion

This device turns ON when the high-speed counter's multi-point output high-speed comparison tables have finished comparing all of the set tables.

## ■ Corresponding devices

The device number is shared for all channels of the CPU module.

CH1	CH2	CH3	CH4	CH5	CH6	CH7	CH8
SM5001							

## ■ Operation description

The content of the operation when ON and when OFF is as follows.

Operation when ON	Operation when OFF
Multi-point output high-speed comparison table completion The comparison of the final table has finished	Multi-point output high-speed comparison tables not finished The comparison has not finished up to the final table



These devices also operate when the FX3 compatible high-speed counter function is valid.

## ■ Update timing

The timing of device update is as follows.

ON	OFF
When multi-point output high-speed comparison tables have finished processing the set amount of tables	<ul style="list-style-type: none"> <li>When OFF by the user</li> <li>Power ON, reset, STOP, PAUSE</li> </ul>



# Special register details

This section describes details about the special registers used with the high-speed counters.

## High-speed counter current value

These devices store the current values of the high-speed counters.

### ■Corresponding devices

The device numbers corresponding to each channel are as follows.

CPU module							
CH1	CH2	CH3	CH4	CH5	CH6	CH7	CH8
SD4501, SD4500	SD4531, SD4530	SD4561, SD4560	SD4591, SD4590	SD4621, SD4620	SD4651, SD4650	SD4681, SD4680	SD4711, SD4710

High-speed pulse input/output module							
First module		Second module		Third module		Fourth module	
CH9	CH10	CH11	CH12	CH13	CH14	CH15	CH16
SD4741, SD4740	SD4771, SD4770	SD4801, SD4800	SD4831, SD4830	SD4861, SD4860	SD4891, SD4890	SD4921, SD4920	SD4951, SD4950

### ■Description

These devices stores the current values of the high-speed counters.

These are signed 32-bit ring counters. (Upper limit value+1 changes to → lower limit value, lower limit value-1 changes to → upper limit value.)

When the ring length is not set, lower limit value: -2147483648, upper limit value: 2147483647.

When the ring length is set, lower limit value: 0, upper limit value: ring length-1.



- To rewrite the current value, use the HCMOV/DHCMOV instruction and transfer the desired value. However, this is the upper limit when set to a value that exceeds the upper limit value, and this is the lower limit value when set to a value that is less than the lower limit value.
- If the current value falls outside the ring length range when the ring length is set, the upper and lower limit values of the ring length are ignored and the current value is used.
- The current value is retained even when the power is OFF.
- When the FX3 compatible high-speed counter function is valid, the same value as one in the LC device (LC35 to LC55) used as the high-speed counter is stored. When the current value is rewritten, the value in the device is also changed, as well as the other way around.

### ■Update timing

The current value of the high-speed counter is updated in END processing or when the HCMOV/DHCMOV instruction is executed. Further, when the FX3 compatible high-speed counter function is valid, the value is updated also when UDCNTF instruction is executed.

### ■Clear timing

The timing when the device is cleared is as follows.

- Cleared by the HCMOV/DHCMOV instruction
- When the RST LC□ instruction executes ON (only when the FX3 compatible high-speed counter function is valid and the applicable LC device is used)
- Power ON, reset, RUN→STOP (only when the FX3 compatible high-speed counter function is valid and the applicable LC device is used)

## High-speed counter maximum value

These devices store the maximum values of the high-speed counters.

### ■Corresponding devices

The device numbers corresponding to each channel are as follows.

CPU module							
CH1	CH2	CH3	CH4	CH5	CH6	CH7	CH8
SD4503, SD4502	SD4533, SD4532	SD4563, SD4562	SD4593, SD4592	SD4623, SD4622	SD4653, SD4652	SD4683, SD4682	SD4713, SD4712

  

High-speed pulse input/output module							
First module		Second module		Third module		Fourth module	
CH9	CH10	CH11	CH12	CH13	CH14	CH15	CH16
SD4743, SD4742	SD4773, SD4772	SD4803, SD4802	SD4833, SD4832	SD4863, SD4862	SD4893, SD4892	SD4923, SD4922	SD4953, SD4952

### ■Description

These devices stores the maximum values of the high-speed counters.

#### Point

- To rewrite the maximum value, only the HCMOV/DHCMOV instruction can be used.
- If using the enable input, the maximum value is updated when the enable input is ON.
- These devices also operate when the FX3 compatible high-speed counter function is valid.
- If LC45 (CH3: Operation equivalent to C245), LC50 (CH4: Operation equivalent to C250) or LC55 (CH4: Operation equivalent to C255) are used when the FX3 compatible high-speed counter function is valid, special register is updated for the first time when enable input is ON. (  Page 291 Assignment for FX3-compatible high-speed counters) After that, regardless of enable input, special register is updated when the high-speed counter starts.

### ■Update timing

When the current value of a high-speed counter exceeds the maximum value, the value is updated in END processing. When the value is read using the HCMOV/DHCMOV instruction, it is first updated to the latest value and then read. Further, when the FX3 compatible high-speed counter function is valid, the value is updated also when UDCNTF instruction is executed.

### ■Clear timing

The timing when the device is cleared is as follows.

- Power ON, Reset

## High-speed counter minimum value

These devices store the minimum values of the high-speed counters.

### ■Corresponding devices

The device numbers corresponding to each channel are as follows.

CPU module							
CH1	CH2	CH3	CH4	CH5	CH6	CH7	CH8
SD4505, SD4504	SD4535, SD4534	SD4565, SD4564	SD4595, SD4594	SD4625, SD4624	SD4655, SD4654	SD4685, SD4684	SD4715, SD4714

  

High-speed pulse input/output module							
First module		Second module		Third module		Fourth module	
CH9	CH10	CH11	CH12	CH13	CH14	CH15	CH16
SD4745, SD4744	SD4775, SD4774	SD4805, SD4804	SD4835, SD4834	SD4865, SD4864	SD4895, SD4894	SD4925, SD4924	SD4955, SD4954

**■Description**

These devices stores the minimum values of the high-speed counters.

**Point**

- To rewrite the minimum value, only the HCMOV/DHCMOV instruction can be used.
- If using the enable input, the minimum value is updated when the enable input is ON.
- These devices also operate when the FX3 compatible high-speed counter function is valid.
- If LC45 (CH3: Operation equivalent to C245), LC50 (CH4: Operation equivalent to C250) or LC55 (CH4: Operation equivalent to C255) are used when the FX3 compatible high-speed counter function is valid, special register is updated for the first time when enable input is ON. (  Page 291 Assignment for FX3-compatible high-speed counters) After that, regardless of enable input, special register is updated when the high-speed counter starts.

**■Update timing**

When the current value of a high-speed counter becomes less than the minimum value, the value is updated in END processing. When the value is read using the HCMOV/DHCMOV instruction, it is first updated to the latest value and then read. Further, when the FX3 compatible high-speed counter function is valid, the value is updated also when UDCNTF instruction is executed.

**■Clear timing**

The timing when the device is cleared is as follows.

- Power ON, Reset

**High-speed counter pulse density**

These devices store the measurement results of pulse density measurement mode.

**■Corresponding devices**

The device numbers corresponding to each channel of the CPU module are as follows.

CH1	CH2	CH3	CH4	CH5	CH6	CH7	CH8
SD4507, SD4506	SD4537, SD4536	SD4567, SD4566	SD4597, SD4596	SD4627, SD4626	SD4657, SD4656	SD4687, SD4686	SD4717, SD4716

**■Description**

These devices store the measurement results of pulse density measurement mode (rotational speed measurement mode).

**Point**

- These devices also store the pulse density measurement when in rotational speed measurement mode.
- If the FX3 compatible high-speed counter function is valid, these devices operate only when the SPD/DSPD instruction operates.

**■Update timing**

The pulse density is updated at each measurement unit time when set to pulse density measurement mode (rotational speed measurement mode) with parameters.

**■Clear timing**

The timing when the device is cleared is as follows.

- Power ON, Reset, STOP/PAUSE→RUN

## High-speed counter rotational speed

These devices store the measurement results of rotational speed measurement mode.

### ■Corresponding devices

The device numbers corresponding to each channel of the CPU module are as follows.

CH1	CH2	CH3	CH4	CH5	CH6	CH7	CH8
SD4509, SD4508	SD4539, SD4538	SD4569, SD4568	SD4599, SD4598	SD4629, SD4628	SD4659, SD4658	SD4689, SD4688	SD4719, SD4718

### ■Description

These devices store the measurement results of rotational speed measurement mode.

#### Point

- These devices also store the rotational speed when in pulse density measurement mode.
- These devices do not operate when the FX3 compatible high-speed counter function is valid.

### ■Update timing

The rotational speed is updated at each measurement unit time when set to rotational speed measurement mode with parameters.

### ■Clear timing

The timing when the device is cleared is as follows.

- Power ON, Reset, STOP/PAUSE→RUN

## High-speed counter preset control switch

These devices set the preset input operation of the high-speed counters.

### ■Corresponding devices

The device numbers corresponding to each channel are as follows.

CPU module							
CH1	CH2	CH3	CH4	CH5	CH6	CH7	CH8
SD4510	SD4540	SD4570	SD4600	SD4630	SD4660	SD4690	SD4720

High-speed pulse input/output module							
First module		Second module		Third module		Fourth module	
CH9	CH10	CH11	CH12	CH13	CH14	CH15	CH16
SD4750	SD4780	SD4810	SD4840	SD4870	SD4900	SD4930	SD4960

### ■Description

These devices set the timing to execute preset input. The table below shows the operations of the setting values.

Setting value	Description
0	Executes the preset on the rising edge.
1	Executes the preset on the falling edge.
2	Executes the preset on both edges.
3	Constantly executes the preset when ON.*1
Other than above	Operates as the rising edge. Executes the preset on the rising edge.

\*1 When the preset control switch is set to "3: Constant when ON", the preset input comparison cannot be used even if the parameter of the preset input comparison (special relay) is enabled.

#### Point

- While the high-speed counter is operating, the value is not reflected even if modified. It operates in the status when the high-speed counter starts.
- These devices also operate when the FX3 compatible high-speed counter function is valid.

## ■Clear timing

The timing when the device is cleared is as follows.

- Power ON, Reset, STOP→RUN

## ■Description of operation

This section describes the operations when the preset input logic and the preset control switch are combined. The preset value is set to 0.

- Operation when preset input logic: positive logic, preset control switch: rising edge

The preset is executed when the preset input changes OFF→ON.

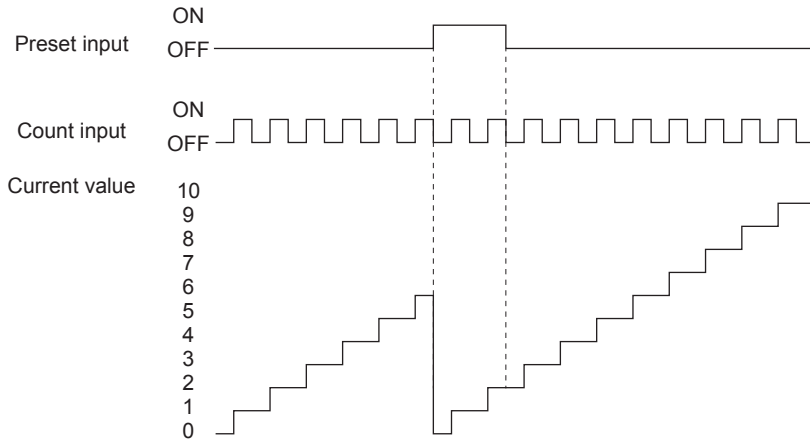

- Operation when preset input logic: positive logic, preset control switch: falling edge

The preset is executed when the preset input changes ON→OFF.

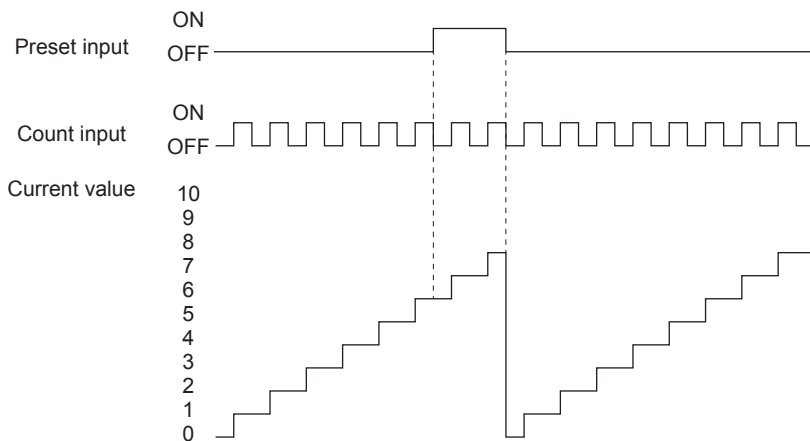

- Operation when preset input logic: positive logic, preset control switch: rising edge + falling edge

The preset is executed when the preset input changes OFF→ON and when it changes ON→OFF.

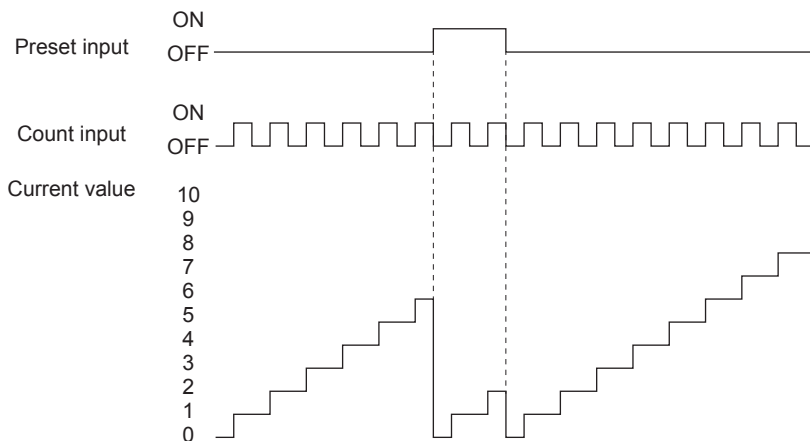

- Operation when preset input logic: positive logic, preset control switch: constant when ON

The preset is constantly executed while the preset input is ON.

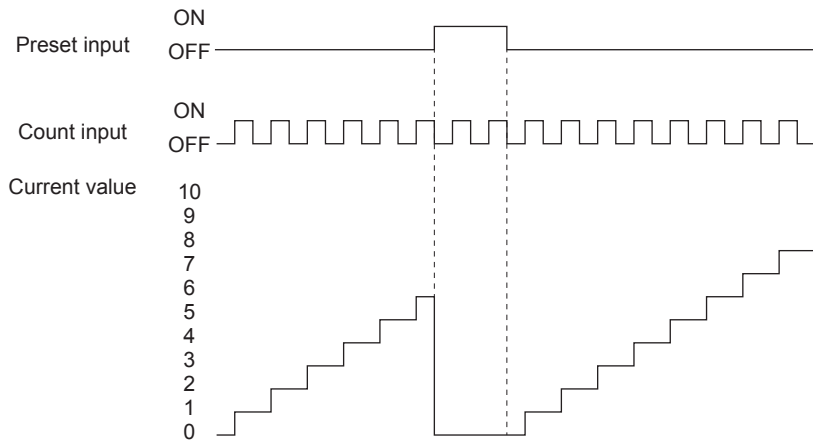

- Operation when preset input logic: negative logic, preset control switch: rising edge

The preset is executed when the preset input changes ON→OFF.

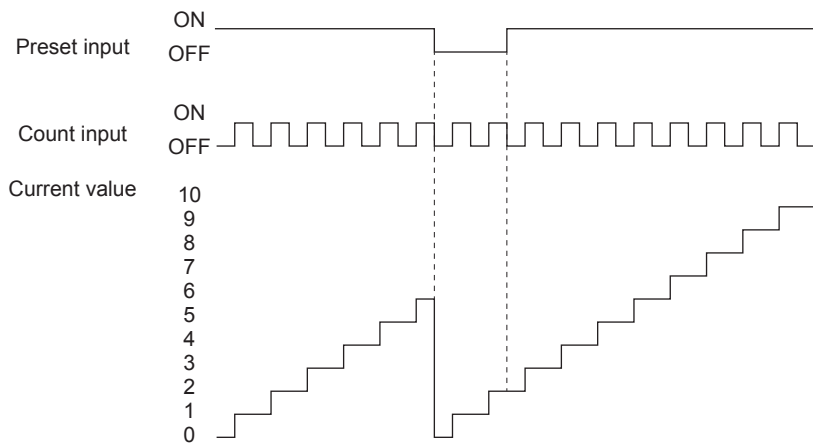

- Operation when preset input logic: negative logic, preset control switch: falling edge

The preset is executed when the preset input changes OFF→ON.

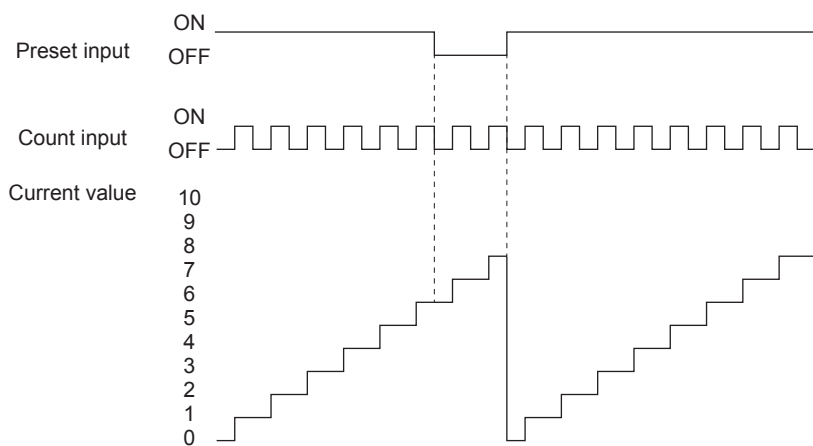

- Operation when preset input logic: negative logic, preset control switch: rising edge + falling edge

The preset is executed when the preset input changes ON→OFF and when it changes OFF→ON.

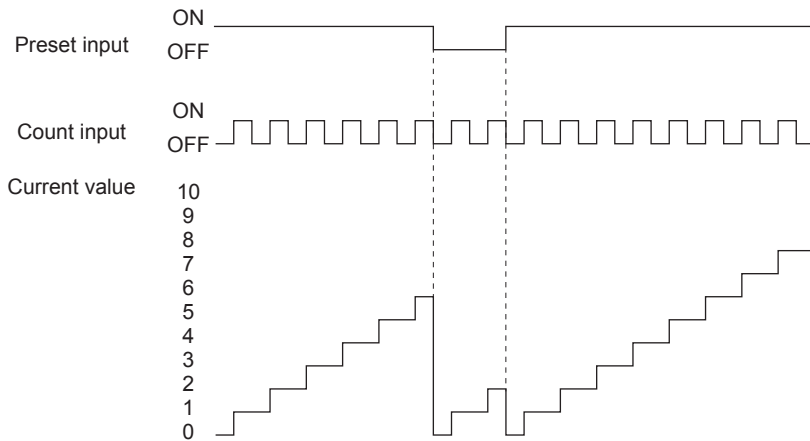

- Operation when preset input logic: negative logic, preset control switch: constant when ON

The preset is constantly executed while the preset input is OFF.

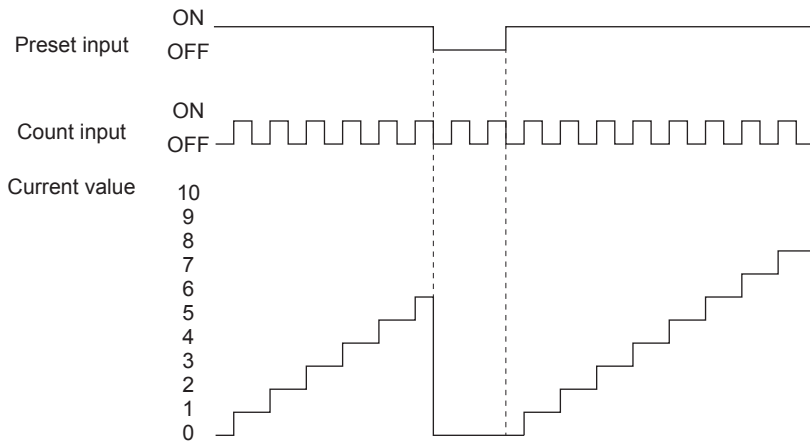

## High-speed counter preset value

These devices set the values to store in the current values when presets are executed.

### ■Corresponding devices

The device numbers corresponding to each channel are as follows.

CPU module							
CH1	CH2	CH3	CH4	CH5	CH6	CH7	CH8
SD4513, SD4512	SD4543, SD4542	SD4573, SD4572	SD4603, SD4602	SD4633, SD4632	SD4663, SD4662	SD4693, SD4692	SD4723, SD4722
High-speed pulse input/output module							
First module		Second module		Third module		Fourth module	
CH9	CH10	CH11	CH12	CH13	CH14	CH15	CH16
SD4753, SD4752	SD4783, SD4782	SD4813, SD4812	SD4843, SD4842	SD4873, SD4872	SD4903, SD4902	SD4933, SD4932	SD4963, SD4962

### ■Description

These devices set the values to set for the current values when presets are executed.

If the preset value is set to be more than the ring length, an error occurs when the high-speed counter is started.

#### Point

- The preset value can also be modified while the high-speed counter is operating. The update timing is END processing.
- These devices also operate when the FX3 compatible high-speed counter function is valid.

## ■Clear timing

The timing when the device is cleared is as follows.

- Power ON, Reset, STOP→RUN

## High-speed counter ring length

These devices set the ring length of the high-speed counters.

### ■Corresponding devices

The device numbers corresponding to each channel are as follows.

CPU module							
CH1	CH2	CH3	CH4	CH5	CH6	CH7	CH8
SD4515, SD4514	SD4545, SD4544	SD4575, SD4574	SD4605, SD4604	SD4635, SD4634	SD4665, SD4664	SD4695, SD4694	SD4725, SD4724

High-speed pulse input/output module							
First module		Second module		Third module		Fourth module	
CH9	CH10	CH11	CH12	CH13	CH14	CH15	CH16
SD4755, SD4754	SD4785, SD4784	SD4815, SD4814	SD4845, SD4844	SD4875, SD4874	SD4905, SD4904	SD4935, SD4934	SD4965, SD4964

### ■Description

These devices set the ring length of the high-speed counters.

These set values are valid when the ring length setting is set to enabled.

#### Point

- While the high-speed counter is operating, the value is not reflected even if modified. It operates in the status when the high-speed counter starts.
- These devices do not operate when the FX3 compatible high-speed counter function is valid.

## ■Clear timing

The timing when the device is cleared is as follows.

- Power ON, Reset, STOP→RUN

## Precautions

If the ring length is set to less than the lower limit value or more than the upper limit value, the ring length operates at the lower limit value or the upper limit value. However, the set value is stored as is.

## High-speed counter measurement unit time

These devices set the measurement unit of pulse density measurement mode.

### ■Corresponding devices

The device numbers corresponding to each channel of the CPU module are as follows.

CH1	CH2	CH3	CH4	CH5	CH6	CH7	CH8
SD4517, SD4516	SD4547, SD4546	SD4577, SD4576	SD4607, SD4606	SD4637, SD4636	SD4667, SD4666	SD4697, SD4696	SD4727, SD4726

### ■Description

These devices set the time to measure pulse density (rotational speed) in 1 ms units when high-speed counters are operating in pulse density measurement mode.

#### Point

- If the value is modified while the high-speed counter is operating, the rewritten value is reflected after the measurement before the value was modified is finished.
- If the FX3 compatible high-speed counter function is valid, these devices operate only when the SPD/DSPD instruction operates. The value in the operand of the SPD/DSPD instruction is written.



### ■Clear timing

The timing when the device is cleared is as follows.

- Power ON, Reset, STOP→RUN

### Precautions

If the set value for the measurement unit time is set to less than the lower limit value or more than the upper limit value, the measurement unit time operates at the lower limit value or the upper limit value. However, the set value is stored as is.

## High-speed counter number of pulses per rotation

These devices set the number of pulses per rotation for rotational speed measurement mode.

### ■Corresponding devices

The device numbers corresponding to each channel of the CPU module are as follows.

CH1	CH2	CH3	CH4	CH5	CH6	CH7	CH8
SD4519, SD4518	SD4549, SD4548	SD4579, SD4578	SD4609, SD4608	SD4639, SD4638	SD4669, SD4668	SD4699, SD4698	SD4729, SD4728

### ■Description

These devices set the number of pulses per rotation when a high-speed counter operates in rotational speed measurement mode. The rotational speed is measured with the set value.

#### Point

- If the value is modified while the high-speed counter is operating, the rewritten value is reflected after the measurement before the value was modified is finished.
- These devices do not operate when the FX3 compatible high-speed counter function is valid.

### ■Clear timing

The timing when the device is cleared is as follows.

- Power ON, Reset, STOP→RUN

### Precautions

If the set value for the number of pulses per rotation is set to less than the lower limit value or more than the upper limit value, the number of pulses per rotation operates at the lower limit value or the upper limit value. However, the set value is stored as is.

## High-speed comparison table (high-speed compare instruction) error occurrence error code

This device stores the high-speed comparison table, high-speed comparison instruction error.

### ■Corresponding devices

The device numbers corresponding to each channel are as follows.

CPU module								High-speed pulse input/output module							
								First module		Second module		Third module		Fourth module	
CH1	CH2	CH3	CH4	CH5	CH6	CH7	CH8	CH9	CH10	CH11	CH12	CH13	CH14	CH15	CH16
SD4982								SD4986		SD4990		SD4994		SD4998	

### ■Description

This device stores the error code when an error occurs in the high-speed comparison table, high-speed comparison instruction.

#### Point

These devices also operate when the FX3 compatible high-speed counter function is valid.

## ■Clear timing

The timing when the device is cleared is as follows.

- Power ON, Reset, SM50 turned ON

## ■Error code

High-speed comparison table maximum excess error: 3780H

## Multi-point output high-speed comparison table comparison number

This device stores the number of the table currently being compared in the multi-point output high-speed comparison tables.

## ■Corresponding devices

The device number is shared for all channels of the CPU module.

CH1	CH2	CH3	CH4	CH5	CH6	CH7	CH8
SD5000							

## ■Description

This device stores the number of the table currently being compared in the multi-point output high-speed comparison tables. If 0, the multi-point output high-speed comparison tables have stopped.

### Point

- When rewriting the comparison value or output data for the multi-point output high-speed comparison tables, the table numbers from the table numbers that follow after the next table number of the table being compared can be rewritten.
- The table number being compared and the next table number after that can be rewritten, but they will not be compared.
- These devices also operate when the FX3 compatible high-speed counter function is valid.

## ■Clear timing

The timing when the device is cleared is as follows.

- Power ON, Reset, STOP→RUN

## Special relays/special registers capable of high-speed transfers with the HCMOV/DHCMOV instruction

The table below shows the devices that can read and write the latest value with the HCMOV/DHCMOV instruction from special relays and special registers related to the high-speed counters. When special relays and special registers are specified for (s) and (d) of instructions other than the HCMOV/DHCMOV instruction, the operation is the same as one compatible with the MOV/DMOV instruction.

### Precautions

- Transfer is not possible between an SM supporting high-speed transfer and an SD supporting high-speed transfer.
- When the device supporting high-speed transfer is set as the transfer source (s) by the DHCMOV instruction while the high-speed input/output function is stopped, the previous value before stop is read out. However, if the function is not executed even once, the initial value is read out.

## Special relays for individual channels

○: High-speed transfer capable (special relay is immediately updated)

△: Normal transfer capable (special relay is updated in END processing)

×: Transfer not possible (read-only)

Special relay	Function	Compatible with HCMOV/ DHCMOV instruction		Compatible with MOV/ DMOV instruction	
		(s)	(d)	(s)	(d)
SM4500 to SM4515	High-speed counter operating	△	×	△	×

Special relay	Function	Compatible with HCMOV/ DHCMOV instruction		Compatible with MOV/ DMOV instruction	
		(s)	(d)	(s)	(d)
SM4516 to SM4531	High-speed counter pulse density/rotational speed being measured	△	×	△	×
SM4532 to SM4547	High-speed counter overflow <sup>*1</sup>	○	○	△	△
SM4548 to SM4563	High-speed counter underflow <sup>*1</sup>	○	○	△	△
SM4564 to SM4579	High-speed counter count direction monitor <sup>*1</sup>	○	×	△	×
SM4580 to SM4595	High-speed counter (1-phase 1-input S/W) count direction switch <sup>*1</sup>	△	○	△	△
SM4596 to SM4611	High-speed counter preset input logic	△	△	△	△
SM4612 to SM4627	High-speed counter preset input comparison	△	△	△	△
SM4628 to SM4643	High-speed counter enable input logic	△	△	△	△
SM4644 to SM4659	High-speed counter ring length setting	△	△	△	△

\*1 In a program with interruption priority 1, the HCMOV/DHCMOV instruction specified with a device for the high-speed pulse input/output module cannot be executed.

## Special relays shared by all channels

○: High-speed transfer capable (special relay is immediately updated)

△: Normal transfer capable (special relay is updated in END processing)

×: Transfer not possible (read-only)

Special relay	Function	Compatible with HCMOV/ DHCMOV instruction		Compatible with MOV/ DMOV instruction	
		(s)	(d)	(s)	(d)
SM4980	High-speed comparison table (high-speed compare instruction) operation (CPU module)	△	×	△	×
SM4982	High-speed comparison table (high-speed compare instruction) error occurrence (CPU module)	△	△	△	△
SM4984	High-speed comparison table operation (high-speed pulse input/output module first module)	△	×	△	×
SM4986	High-speed comparison table error occurrence (high-speed pulse input/output module first module)	△	△	△	△
SM4988	High-speed comparison table operation (high-speed pulse input/output module second module)	△	×	△	×
SM4990	High-speed comparison table error occurrence (high-speed pulse input/output module second module)	△	△	△	△
SM4992	High-speed comparison table operation (high-speed pulse input/output module third module)	△	×	△	×
SM4994	High-speed comparison table error occurrence (high-speed pulse input/output module third module)	△	△	△	△
SM4996	High-speed comparison table operation (high-speed pulse input/output module fourth module)	△	×	△	×
SM4998	High-speed comparison table error occurrence (high-speed pulse input/output module fourth module)	△	△	△	△
SM5000	Multi-point output high-speed comparison table operation	△	×	△	×
SM5001	Multi-point output high-speed comparison table completion	○	△	△	△

## Special registers for individual channels

This section only lists the devices for high-speed counter CH1. The devices for high-speed counter CH2 and subsequent counters have the same operation as CH1.

○: High-speed transfer capable (special register is immediately updated)

△: Normal transfer capable (special register is updated in END processing)

×: Transfer not possible (read-only)

Special register	Function	Compatible with HCMOV/DHCMOV instruction		Compatible with MOV/DMOV instruction	
		(s)	(d)	(s)	(d)
SD4500	High-speed counter current value (CH1)*1	○	○	△	×
SD4501					
SD4502	High-speed counter maximum value (CH1)*1	○	○	△	×
SD4503					
SD4504	High-speed counter minimum value (CH1)*1	○	○	△	×
SD4505					
SD4506	High-speed counter pulse density (CH1)	△	△	△	△
SD4507					
SD4508	High-speed counter rotational speed (CH1)	△	△	△	△
SD4509					
SD4510	High-speed counter preset control switch (CH1)	△	△	△	△
SD4512	High-speed counter preset value (CH1)*1	△	○	△	△
SD4513					
SD4514	High-speed counter ring length (CH1)	△	△	△	△
SD4515					
SD4516	High-speed counter measurement unit time (CH1)	△	△	△	△
SD4517					
SD4518	High-speed counter number of pulses per rotation (CH1)	△	△	△	△
SD4519					

\*1 In a program with interruption priority 1, the HCMOV/DHCMOV instruction specified with a device for the high-speed pulse input/output module cannot be executed.

### Point

Always use DHCMOV (32-bit instruction) for devices that use 2 words. When the HCMOV instruction (16-bit instruction) is used, it operates the same as the normal MOV instruction.

## Special registers shared by all channels

○: High-speed transfer capable (special register is immediately updated)

△: Normal transfer capable (special register is updated in END processing)

×: Transfer not possible (read-only)

Special register	Function	Compatible with HCMOV/DHCMOV instruction		Compatible with MOV/DMOV instruction	
		(s)	(d)	(s)	(d)
SD4982	High-speed comparison table (high-speed compare instruction) error occurrence error code (CPU module)	△	△	△	△
SD4986	High-speed comparison table error occurrence error code (high-speed pulse input/output module first module)	△	△	△	△
SD4990	High-speed comparison table error occurrence error code (high-speed pulse input/output module second module)	△	△	△	△
SD4994	High-speed comparison table error occurrence error code (high-speed pulse input/output module third module)	△	△	△	△
SD4998	High-speed comparison table error occurrence error code (high-speed pulse input/output module fourth module)	△	△	△	△
SD5000	Multi-point output high-speed comparison table comparison number	△	×	△	△

## Precautions when using high-speed counters

This section describes the precautions when using high-speed counters.

### Common precautions when using high-speed counter instructions and parameters

This section describes the common precautions when using high-speed comparison tables and multi-point output comparison tables with the high-speed counter instructions (DHSCS, DHSCR, DHSZ instructions) or parameters. For the individual precautions on high-speed counter instructions, refer to [MELSEC iQ-F FX5 Programming Manual \(Instructions, Standard Functions/Function Blocks\)](#).

#### High-speed counter devices

The current values for high-speed counters are checked with special registers for each channel.

To start or stop counting of the high-speed counters, use the HIOEN/DHIOEN instruction or the SPD/DSPD instruction.

- High-speed counter start/stop conditions

Function	Start	Stop
Counting	<ul style="list-style-type: none"> <li>• HIOEN/DHIOEN instruction</li> <li>• SPD/DSPD instruction</li> </ul>	<ul style="list-style-type: none"> <li>• HIOEN/DHIOEN instruction</li> <li>• SPD/DSPD instruction*1</li> </ul>
Comparison processing	<ul style="list-style-type: none"> <li>• HIOEN/DHIOEN instruction</li> <li>• DHSCS, DHSCR, DHSZ instructions</li> </ul>	<ul style="list-style-type: none"> <li>• HIOEN/DHIOEN instruction</li> <li>• DHSCS, DHSCR, DHSZ instructions*2</li> </ul>

\*1 Can be stopped when counting was started with the SPD/DSPD instruction.

\*2 Can be stopped when the high-speed comparison table is not set with parameters.

#### Precautions for the counting operation when the current value is changed

For the high-speed counter instructions, high-speed comparison tables, and multi-point output high-speed comparison tables, comparison processing is performed when the current value of the high-speed counter has changed due to pulse input. When the preset input comparison function is also enabled, comparison processing is also performed when the preset is executed. However, please note that the comparison processing is not performed when the current value of the high-speed counter is changed with the following methods.

- When the current value of a high-speed counter was rewritten with the HCMOV/DHCMOV instruction.
- When the current value of the high-speed counter is reset with the RST instruction or the ZRST instruction (when the FX3 compatible high-speed counter function is valid)
- When the current value of the high-speed counter was changed by a self-reset. (When the preset input comparison function is disabled)
- When high-speed counter current value is the ON or OFF output result of the comparison of the DHSCS, DHSCR, DHSZ instructions.
- When high-speed counter current value is the ON or OFF output result of the comparison of a high-speed comparison table.

#### Preset input comparison operation

When the preset input comparison is enabled and preset control switching is set to constant when ON, the preset input comparison does not operate.

#### Timing at which the instruction is enabled

The DHSCS, DHSCR, DHSZ instructions are enabled at the END instruction for the scan in which the instructions are driven. Even when the comparison value is changed, it is updated at the END instruction for the scan in which it was changed.

#### Configuring high-speed comparison tables with parameters

Operations of DHSCS, DHSCR, DHSZ instructions of the same comparison value are executed after high-speed comparison tables set with parameters. The high-speed comparison table is processed sequentially from the top of the table.

## ■High-speed counter current value modification operation by instructions

The table below shows the operations when the current value of a high-speed counter is rewritten by instructions.

Instruction	High-speed counter current value
HCMOV/DHCMOV instruction	☞ Page 280 Special relays/special registers capable of high-speed transfers with the HCMOV/DHCMOV instruction
MOV instruction, etc.	
RST instruction	Cannot reset. The special register value is overwritten in END processing.
ZRST instruction	Cannot reset. The special register value is overwritten in END processing.

## ■Limitation in the number of instances of each instruction in a program and number of instructions driven at the same time

When DHSCS, DHSCR, DHSZ instructions are driven at the same time in excess of the upper limit, the instructions after the upper limit do not operate.

Instruction	Limitation in number of instructions driven at same time
DHSCS	Up to 32 instructions can be driven at the same time.
DHSCR	There is no limitation in the number used in programs.
DHSZ	

- Configuring high-speed comparison tables with parameters

The number of instructions driven at the same time decreases by 1 for each high-speed comparison table driven by the HIOEN/DHIOEN instruction.

The HIOEN/DHIOEN instruction that drives the high-speed comparison table is capable of driving at the same time 32 instructions in the case of a CPU module and 15 instructions in the case of a high-speed pulse input/output module.

### Restriction

Set up the program and configure the settings within the range calculated with the following equation due to the limitations described above.

- CPU module

$32 \geq \text{Number of driven high-speed comparison tables} + \text{Number of DHSCS, DHSCR, DHSZ instructions driven at the same time}$

However, restriction of number of high-speed comparisons differs depending on the version. (☞ Page 966 Added and Enhanced Functions)

- High-speed pulse input/output module

$15 \geq \text{Number of driven high-speed comparison tables}$

## ■User interrupt

During a program with interruption priority 1, the HIOEN/DHIOEN instruction cannot be executed to start or stop the high-speed counter of a high-speed pulse input/output module. (☞ Page 109 Interrupt priority)

## ■Operation when the all output disable flag (SM8034) is ON

When the all output disable flag (SM8034) is turned ON, the outputs that were turned ON by high-speed comparison tables, high-speed comparison instructions, or multi-point output high-speed tables are turned OFF. (The image remains ON.)

If SM8034 is turned OFF, the outputs that were turned OFF return to the original state.

For high-speed comparison tables and high-speed comparison instructions, high-speed counters do not stop and comparison processing is performed even when SM8034 is ON, and the image turns ON if there is a match. The actual output is output when SM8034 is OFF.

For multi-point output high-speed comparison tables, the high-speed counter for which the multi-point output high-speed comparison table is operating is stopped when SM8034 is turned ON, and multi-point output comparison processing is also stopped. High-speed counters and multi-point output high-speed comparison tables cannot be operated by turning OFF SM8034 and need to be restarted by the HIOEN/DHIOEN instruction.

The normal high-speed counter function continues to perform counting without being influenced by SM8034.

## ■Operation of high-speed comparison table and multiple point output high-speed comparison tables

Do not use the channel of the same high-speed counter on a high-speed comparison table and a multi-point output high-speed comparison table. An error may occur.

## Functions that share inputs and outputs

When using input/output for high-speed input/output function, other high-speed input/output functions cannot be used together depending on the combination. For details on the positioning function, refer to the following.

☞ Page 348 POSITIONING CONTROL FUNCTION

### ■FX5UJ CPU module

#### • Input

The following functions occupy inputs of the high-speed input/output function.

Function		Up to CH/axis	Device	Simultaneous useable function
Input interrupt*1	Interrupt (Rising)	8 CH	X0 to X17	The functions other than high-speed counter (input A phase, input B phase)
	Interrupt (Falling)			
	Interrupt (Rising + Falling)			
	Interrupt (Rising) + Pulse Catch			Cannot be combined
High-speed counter	Input A phase	8 CH*2	X0 to X17	—
	Input B phase			
	Input external preset			Input interrupt
	Input external enable			
Pulse width measurement		4 CH	X0, X1, X3, X4	Input interrupt
Positioning	Near-point dog signal	3 axis	X0 to X17	• Input interrupt • Zero signal
	Zero signal	3 axis	X0 to X17	• Input interrupt • Near-point dog signal
	Interrupt input signal 1 (Normal mode)	3 axis	X0 to X17	Input interrupt
	External start signal	3 axis	X0 to X17	Input interrupt

\*1 If used simultaneously with another function, the input logic of the other function is applied.

\*2 When external preset input and external enable input are used, the number of usable channels is decreased depending on the counter type.

#### • Output

The following functions occupy outputs of the high-speed input/output function. The following functions cannot be combined with other high-speed input/output functions.

Function		Up to CH/axis	Device
PWM*1		4 CH	Y0 to Y7
Positioning	PULSE	3 axis	Y0 to Y2
	SIGN		Y0 to Y17
	Clear signal	3 axis	Y0 to Y17

\*1 When positioning is not used, the output devices (Y) for which the positioning setting is enabled with parameters can be used as PWM outputs or general-purpose devices having no parameter.

## Precautions

Do not specify an output device (Y) used by the high-speed input/output function as the output destination of the high-speed comparison table. This may cause an unexpected operation.

## ■FX5S/FX5U/FX5UC CPU module

### • Input

The following functions occupy inputs of the high-speed input/output function.

Function		Up to CH/axis	Device	Simultaneous useable function
Input interrupt <sup>*1</sup>	Interrupt (Rising)	8 CH	X0 to X17	The functions other than high-speed counter (input A phase, input B phase)
	Interrupt (Falling)			
	Interrupt (Rising + Falling)			
	Interrupt (Rising) + Pulse Catch			Cannot be combined
High-speed counter	Input A phase	8 CH <sup>*2</sup>	X0 to X17	—
	Input B phase			
	Input external preset			Input interrupt
	Input external enable			
Pulse width measurement		4 CH	X0 to X7	Input interrupt
Positioning	Near-point dog signal	4 axis	X0 to X17	• Input interrupt • Zero signal
	Zero signal	4 axis	X0 to X17	• Input interrupt • Near-point dog signal
	Interrupt input signal 1 (Normal mode)	4 axis	X0 to X17	Input interrupt
	External start signal	4 axis	X0 to X17	Input interrupt

\*1 If used simultaneously with another function, the input logic of the other function is applied.

\*2 When external preset input and external enable input are used, the number of usable channels is decreased depending on the counter type.

### • Output

The following functions occupy outputs of the high-speed input/output function. The following functions cannot be combined with other high-speed input/output functions.

Function		Up to CH/axis	Device
PWM <sup>*1</sup>		4 CH	Y0 to Y7
Positioning	PULSE	4 axis	Y0 to Y3
	SIGN		Y0 to Y17
	CW	2 axis	Y0, Y1
	CCW		Y2, Y3
	Clear signal	4 axis	Y0 to Y17

\*1 When positioning is not used, the output devices (Y) for which the positioning setting is enabled with parameters can be used as PWM outputs or general-purpose devices having no parameter.

## Precautions

Do not specify an output device (Y) used by the high-speed input/output function as the output destination of the high-speed comparison table. This may cause an unexpected operation.



## High-speed pulse input/output module

### • Input

The following functions occupy inputs of the high-speed input/output function. The channels and the axis numbers are in module internal order.

Device*1	Input interrupt*1*2	High-speed counter	Pulse width measurement	Positioning
X□	X□	CH1 Input A phase	—	—
X□+1	X□+1	CH1 Input B phase/external preset	—	—
X□+2	X□+2	CH1 Input external preset	—	Axis2 Zero signal
X□+3	X□+3	CH2 Input A phase	CH1	Axis2 Interrupt input signal 1
X□+4	X□+4	CH2 Input B phase/external preset	CH2	Axis1 Interrupt input signal 1
X□+5	X□+5	CH2 Input external preset	—	Axis1 Zero signal
X□+6	X□+6	CH1 Input external enable	—	Axis2 External start signal
X□+7	X□+7	CH2 Input external enable	—	Axis1 External start signal

\*1 The number in □ is the head input number for each high-speed pulse input/output module.

\*2 Simultaneous use with a function other than the high-speed counter (A phase/B phase input) is possible. However, use with the channel 2 external enable input of the high-speed counter is not possible. However, the input logic of other functions is applied.

### • Output

The following functions occupy outputs of the high-speed input/output function. The channels and the axis numbers are in module internal order. The following functions cannot be combined with other high-speed input/output functions.

Device*1	PWM	Positioning
Y□	—	Axis1 PULSE/CW
Y□+1	CH1	Axis2 PULSE/CW
Y□+2	—	Axis1 Clear signal
Y□+3	—	Axis2 Clear signal
Y□+4	—	Axis1 SIGN/CCW
Y□+5	CH2	Axis2 SIGN/CCW
Y□+6	—	—
Y□+7	—	—

\*1 The number in □ is the head output number for each high-speed pulse input/output module.

## Precautions

Do not specify an output device (Y) used by the high-speed input/output function as the output destination of the high-speed comparison table. This may cause an unexpected operation.

## Restrictions on simultaneous execution of the high-speed comparison table and high-speed comparison instructions

There is a limit in the number of simultaneous executions of the high-speed comparison table and high-speed comparison instructions (DHSCS, DHSCR, DHSZ instruction). Shown below are conditions included in the number of simultaneous executions.

Item	CPU module	High-speed pulse input/output module
Maximum executions	32	15
High-speed counter function	<ul style="list-style-type: none"> <li>• Drive high-speed comparison table (Drive HIOEN/DHIOEN instruction)</li> <li>• Drive DHSCS, DHSCR, DHSZ instruction</li> </ul>	<ul style="list-style-type: none"> <li>• Drive high-speed comparison table (Drive HIOEN/DHIOEN instruction)</li> </ul>
Positioning function	<ul style="list-style-type: none"> <li>• Interrupt input signal 1 (High-speed mode) setting is enabled</li> </ul>	<ul style="list-style-type: none"> <li>• OPR setting is enabled</li> <li>• Interrupt input signal 1 (High-speed mode) setting is enabled</li> </ul>

### Point

- For the high-speed comparison table, only the tables driven by the HIOEN/DHIOEN instruction are included in the number of the simultaneous executions.
- When the positioning function setting is made, high-speed comparison table becomes occupied and is included in the number of simultaneous executions.

## 26.2 FX3-compatible High-speed Counter Function

FX3-compatible high-speed counter function is explained below.

### FX3-compatible high-speed counter function overview

The FX3 compatible high-speed counter can assign the input terminals compatible with FX3 and use the device equivalent to C235 to C255 of FX3 as LC35 to LC55 (high-speed counter). The FX3-compatible high-speed counter function is not supported in high-speed pulse input/output modules.

If the FX3 compatible high-speed counter is used, it is necessary to use the parameter to set the FX3 compatible high-speed counter to be valid.

This section describes the device (LC35 to LC55) of the FX3 compatible high-speed counter as an LC device.

#### Point

The FX3 compatible high-speed counter is convenient if it is used when a replacement is made from FX3 or for a similar occasion. If a high-speed counter is newly used, use the high-speed counter function of FX5.

( Page 232 High-speed Counter Function)

### How to start/stop the high-speed counter using the LC device

When using a FX3-compatible high-speed counter by the UDCNTF instruction, perform starting/stopping the counting of the high-speed counter. For details of the UDCNTF instruction, refer to  MELSEC iQ-F FX5 Programming Manual (Instructions, Standard Functions/Function Blocks).

#### Count direction switching

FX3-compatible high-speed count direction switching is performed by ON/OFF of the following methods.

- SM4580 to SM4595 (high-speed counter CH1 to CH16 (1-phase 1-input S/W) count direction switching)

#### Programs example

In the case of a program shown below, the counting starts when M0 turns ON, and the counting stops when M0 turns OFF. When the counter increases from -6 or less to -5 or higher during an execution of the UDCNTF instruction, the counter contact turns ON, and the counter contact turns OFF when the counter decreases from -5 or higher to -6 or lower. ON/OFF of M1 switches the counting direction. To count from 0, turn ON M2 to reset LC35.

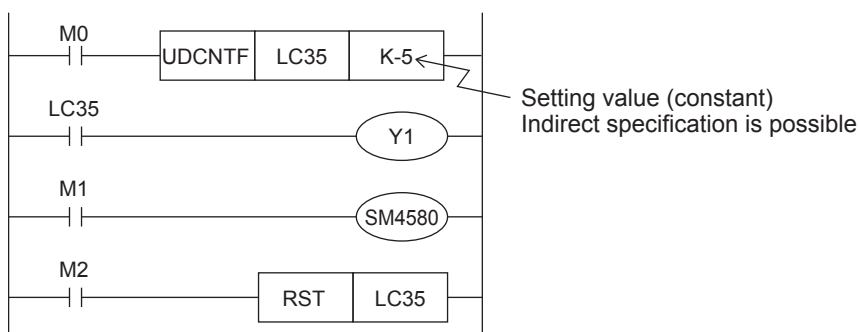

#### Point

- The current value of LC35 is updated when the UDCNTF instruction is executed.
- When LC35 is set to (s) of the DHCMOV instruction, the newest value can be read out.
- When a high-speed comparison instruction (DHSCS instruction, DHSCR instruction, DHSZ instruction), a high-speed comparison table, or a multi-point output high-speed comparison table are used, an accurate comparison and matched output processing can be executed.

The set value (positive or negative) can be specified by a constant (K) or the contents of data registers (D). When data registers are used, 32-bit data composed of two consecutive devices are treated as set values. If D0 is specified, the pair of D1 and D0 are the setting value of 32 bits.

## Operation example

The operation of LC35 in the programming example described above is as shown below.

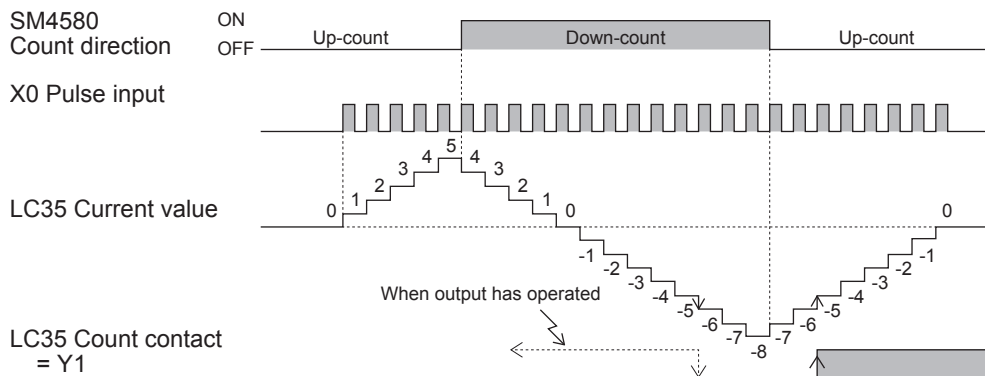

## The elements of the composition of the LC device

Each element that composes the LC device is shown below.

Item	Description
Counting coil	This is the activation contact to start the counting of the LC device. When the UDCNTF instruction is turned OFF→ON, the status turns ON and the counting of the input signal becomes possible.
Setting value	This is K○ specified with UDCNTF LC□ K○. An indirect specification is acceptable.
Current value	This is the current value of the counter. The value increases or decreases depending on the input pulse.
Counter contact	This turns ON when the current value of the LC device changes from a value less than the setting value to the setting value or higher. This can be used as LD LC□.
Reset coil	This turns ON when the RST instruction with the LC device specified turns OFF→ON, and turns OFF when the RST instruction turns ON→OFF. When the reset coil is ON, the counting is not executed even if the count coil is ON, and the current value is always 0.

## The comparison between the UDCNTF instruction and HIOEN/DHIOEN instruction

The comparison between the UDCNTF instruction and the HIOEN/DHIOEN instruction is described below.

### The availability of use when the FX3 compatibility function is enable/disable

○: Use, —: Not use

FX3-compatible function enable/disable	UDCNTF instruction	HIOEN/DHIOEN instruction
Disable	—	○
Enable	○	○

#### Point

The LC device can be used as a high-speed counter only when the FX3 compatible function is valid. However, this is only the LC device that is set up with parameter. Also, it is possible to use the HIOEN/DHIOEN instruction.

## Starting/stopping the counting of the high-speed counter

The start and stop of the counting of the high-speed counter of the UDCNTF instructions and HIOEN/DHIOEN instructions with the FX3 compatible function valid are described below.

For the UDCNTF instruction or HIOEN/DHIOEN instruction, refer to  MELSEC iQ-F FX5 Programming Manual (Instructions, Standard Functions/Function Blocks).

○: Supported, ×: Not supported, —: Not compatible

Starting/stopping the counting of the high-speed counter	UDCNTF instruction	HIOEN/DHIOEN instruction
The start of the high-speed counter	○	○
The simultaneous start of multiple CH	×	○
The simultaneous stop of multiple CH	×	○
The start→stop and the stop→start of the same CH in one scan	○	○
The stop of the counter started by the UDCNTF instructions in the same step	○	—
The stop of the counter started by the UDCNTF instructions in a different step	○	×
The stop of the counter started by the HIOEN/DHIOEN instruction the same step	—	○
The stop of the counter started by the HIOEN/DHIOEN instruction a different step	○	○

### Point

- If the UDCNTF instructions and HIOEN/DHIOEN instructions are used for the same CH, it is not possible to use the HIOEN/DHIOEN instruction to stop the high-speed counter started by UDCNTF instructions. On the other hand, the instruction started by the HIOEN/DHIOEN instruction can be stopped by executing ON→OFF of UDCNTF instructions. Use caution when the HIOEN/DHIOEN instruction and UDCNTF instructions are used together.
- Do not drive the same LC device number at the same time.
- Do not duplicate output (double coil) the same LC device number with multiple instructions.

## The operation of each element of the current value of a started counter and the LC device

Shown below is the operations of the SD device, the current value of the LC device, and each element of the LC device when the counting is started with UDCNTF instructions or is started with the HIOEN/DHIOEN instruction while the FX3 compatible function is valid.

○: Operate, ×: Not operate

The current value of the SD device, each element of the LC device	The start with UDCNTF instruction	The start with HIOEN/DHIOEN instruction
The current value of the SD device	○	○
The current value of the LC device	○	○
The LC device counting coil	○	×
The counter contact point of the LC device	○	×
The reset coil of the LC device	○	○

### Point

- When a count is started by HIOEN/DHIOEN instruction, although LC device changes, neither a counting coil nor the counter contact operates. Moreover, when operation is started by HIOEN/DHIOEN instruction and LC□ corresponding to CH is reset, during the RST instruction ON, operation is stopped and calculation is resumed in OFF of the RST instruction.

## Assignment for FX3-compatible high-speed counters

### The high-speed counter number that can be specified with each CH

Shown here are the high-speed counter numbers (C235 to C255) of FX3 that can be selected with each CH.

○: Change is possible, —: Change is impossible

CH	High-speed counter No.	Pulse input mode	Corresponding devices	Preset input logic change
CH1	C235	1-phase 1-count (S/W)	LC35	—
CH1	C241	1-phase 1-count (S/W)	LC41	○
CH1	C244	1-phase 1-count (S/W)	LC44	○
CH1	C246	1-phase 2-count	LC46	—
CH1	C247	1-phase 2-count	LC47	○
CH1	C249	1-phase 2-count	LC49	○
CH1	C251	2-phase 2-count (1 edge count/4 edge count)	LC51	—
CH1	C252	2-phase 2-count (1 edge count/4 edge count)	LC52	○
CH1	C254	2-phase 2-count (1 edge count/4 edge count)	LC54	○
CH2	C236	1-phase 1-count (S/W)	LC36	—
CH3	C237	1-phase 1-count (S/W)	LC37	—
CH3	C242	1-phase 1-count (S/W)	LC42	○
CH3	C245	1-phase 1-count (S/W)	LC45	○
CH4	C238	1-phase 1-count (S/W)	LC38	—
CH4	C248	1-phase 2-count	LC48	○
CH4	C248 (OP)	1-phase 2-count	LC48	—
CH4	C250	1-phase 2-count	LC50	○
CH4	C253	2-phase 2-count (1 edge count/4 edge count)	LC53	○
CH4	C253 (OP)	2-phase 2-count (1 edge count/4 edge count)	LC53	—
CH4	C255	2-phase 2-count (1 edge count/4 edge count)	LC55	○
CH5	C239	1-phase 1-count (S/W)	LC39	—
CH5	C243	1-phase 1-count (S/W)	LC43	○
CH6	C240	1-phase 1-count (S/W)	LC40	—
CH7	C244 (OP)	1-phase 1-count (S/W)	LC44	—
CH7	C254 (OP)	2-phase 2-count (1 edge count)	LC54	—
CH8	C245 (OP)	1-phase 1-count (H/W)	LC45	—

## The assignment of the high-speed counter and the maximum frequency when the FX3 compatible function is valid

Shown below is the assignment of the high-speed counter and the maximum frequency when the FX3 compatible function is valid.

CH	High-speed counter No.	FX5 corresponding devices	X0	X1	X2	X3	X4	X5	X6	X7	Maximum frequency		
											FX5UJ CPU module	FX5U/ FX5UC CPU module (32 points type)	FX5U/ FX5UC CPU module (64 points or more type)
CH1	C235	LC35	A								100 kHz	200 kHz	200 kHz
CH2	C236	LC36		A							100 kHz	200 kHz	200 kHz
CH3	C237	LC37			A						10 kHz	200 kHz	200 kHz
CH4	C238	LC38				A					100 kHz	200 kHz	200 kHz
CH5	C239	LC39					A				100 kHz	200 kHz	200 kHz
CH6	C240	LC40						A			10 kHz	200 kHz	200 kHz
CH1	C241	LC41	A	P							100 kHz	200 kHz	200 kHz
CH3	C242	LC42			A	P					10 kHz	200 kHz	200 kHz
CH5	C243	LC43					A	P			100 kHz	200 kHz	200 kHz
CH1	C244	LC44	A	P					E		100 kHz	200 kHz	200 kHz
CH7	C244 (OP)	LC44							A		10 kHz	10 kHz	200 kHz
CH3	C245	LC45			A	P				E	10 kHz	200 kHz	200 kHz
CH8	C245 (OP)	LC45								A	10 kHz	10 kHz	200 kHz
CH1	C246	LC46	A	B							100 kHz	200 kHz	200 kHz
CH1	C247	LC47	A	B	P						100 kHz	200 kHz	200 kHz
CH4	C248	LC48				A	B	P			100 kHz	200 kHz	200 kHz
CH4	C248 (OP)	LC48				A	B				100 kHz	200 kHz	200 kHz
CH1	C249	LC49	A	B	P				E		100 kHz	200 kHz	200 kHz
CH4	C250	LC50				A	B	P		E	100 kHz	200 kHz	200 kHz
CH1	C251 (1 edge count)	LC51	A	B							100 kHz	200 kHz	200 kHz
CH1	C251 (4 edge count)	LC51	A	B							25 kHz	50 kHz	50 kHz
CH1	C252 (1 edge count)	LC52	A	B	P						100 kHz	200 kHz	200 kHz
CH1	C252 (4 edge count)	LC52	A	B	P						25 kHz	50 kHz	50 kHz
CH4	C253 (1 edge count)	LC53				A	B	P			100 kHz	200 kHz	200 kHz
CH4	C253 (4 edge count)	LC53				A	B	P			25 kHz	50 kHz	50 kHz
CH4	C253 (OP) (1 edge count)	LC53				A	B				100 kHz	200 kHz	200 kHz
CH4	C253 (OP) (4 edge count)	LC53				A	B				25 kHz	50 kHz	50 kHz
CH1	C254 (1 edge count)	LC54	A	B	P				E		100 kHz	200 kHz	200 kHz
CH1	C254 (4 edge count)	LC54	A	B	P				E		25 kHz	50 kHz	50 kHz
CH7	C254 (OP)	LC54							A	B	10 kHz	10 kHz	200 kHz
CH4	C255 (1 edge count)	LC55				A	B	P		E	100 kHz	200 kHz	200 kHz
CH4	C255 (4 edge count)	LC55				A	B	P		E	25 kHz	50 kHz	50 kHz

A: Input A phase, B: Input B phase, P: Input external preset, E: Input external enable

## FX3-compatible high-speed counter setting

This section describes the setting of the case when the FX3 compatible high-speed counter is used.  
FX3-compatible high-speed counter are set by GX Works3.





### Point

- If a high-speed comparison table or a multi-point output high-speed comparison table is used, it is necessary to set the parameter in the same manner as the FX5 high-speed counter.
- It is necessary to specify also the input response time.

### Parameter setting

FX3-compatible high-speed counter parameter setting method is explained below.

For parameter setting of each operation, refer to the following.

- For FX3-compatible high-speed counters, refer to  Page 293 FX3-compatible high-speed counter.
- For high-speed comparison table, refer to  Page 254 High-speed comparison table.
- For multiple point output, high-speed comparison tables, refer to  Page 257 Multiple point output, high-speed comparison tables.
- For input response time, refer to  Page 316 General-purpose Input Functions.

## FX3-compatible high-speed counter

FX3 compatible high-speed counter setting method is explained below.

1. Set the method of specifying the high-speed counter to "long counter setting".

 Navigation window ⇒ [Parameter] ⇒ [Module model name] ⇒ [Module Parameter] ⇒ [High Speed I/O] ⇒ "Input Function" ⇒ "High Speed Counter" ⇒ "Detailed Setting" ⇒ "Other"

### Window

Item	CH
<b>Specification method for high speed counter</b>	<b>Select the high-speed counter for the FX3 series compatible input assignment.</b>
Specification method for high speed counter	<a href="#">Long Counter Specification</a>

### Displayed items

Item	Description	Setting range	Default
Specification method for high speed counter	Set up whether or not to use FX3 compatibility assignment for high speed counter. <ul style="list-style-type: none"> <li>• When using FX5 high-speed counter, choose "normal".</li> <li>• When using FX3 compatible high-speed counter, choose "long counter specification".</li> </ul>	<ul style="list-style-type: none"> <li>• Normal</li> <li>• Long Counter Specification</li> </ul>	Normal

2. Set up the FX3 compatible high-speed counter.

The counter number and function that can be specified are different from CH to CH. ( Page 291 Assignment for FX3-compatible high-speed counters)

 Navigation window ⇒ [Parameter] ⇒ [Module model name] ⇒ [Module Parameter] ⇒ [High Speed I/O] ⇒ "Input Function" ⇒ "High Speed Counter" ⇒ "Detailed Setting" ⇒ "Basic Settings"

## Window

Item	CH1	CH2	CH3
<b>Use/Do Not Use Counter</b>	<b>Set whether to use counter or not.</b>		
Use/Not Use	Enable	Enable	Enable
<b>Counter device</b>	<b>Select the high-speed counter for the FX3 series compatible input assignment.</b>		
Counter device	LC35 (Operation equivalent to C235)	LC36 (Operation equivalent to C236)	LC37 (Operation equivalent to C237)
<b>Operation Mode</b>	<b>Set operation mode.</b>		
Operation Mode	Normal Mode	Normal Mode	Normal Mode
<b>Pulse Input Mode</b>	<b>Set pulse input mode.</b>		
Pulse Input Mode	1-Phase 1 Input (S/W Up/Down Switch)	1-Phase 1 Input (S/W Up/Down Switch)	1-Phase 1 Input (S/W Up/Down Switch)
<b>Preset Input</b>	<b>Set preset input.</b>		
Preset Input Enable/Disable	Disable	Disable	Disable
Input logic	Positive Logic	Positive Logic	Positive Logic
Preset Value	0	0	0
Input Comparison Enable/Disable	Enable	Enable	Disable
Control Switch	Rising	Rising + Falling Edge	Falling
<b>Enable Input</b>	<b>Set enable input.</b>		
Enable Input Enable/Disable	Disable	Disable	Disable
Input logic	Positive Logic	Positive Logic	Positive Logic
<b>Ring Length Setting</b>	<b>Set ring length.</b>		
Ring Length Enable/Disable	Disable	Disable	Disable
Ring Length	2147483648	2147483648	2147483648
<b>Measurement Unit Time</b>	<b>Set the measurement unit time (ms) for the pulse density measurement mode and rotation speed measurement mode.</b>		
Measurement Unit Time	1000	1000	1000
<b>No. of Pulse per Rotation</b>	<b>Set the number of pulses per rotation when using the rotation speed measurement mode.</b>		
No. of Pulse per Rotation	1000	1000	1000

## Displayed items

Item	Description	Setting range	Default
Use/Not Use	Set whether use counter or not.	<ul style="list-style-type: none"> <li>• Disable</li> <li>• Enable</li> </ul>	—
Counter device	Select the high speed counter of input assignment which is compatible with FX3.	CH1 <ul style="list-style-type: none"> <li>• LC35 (Operation equivalent to C235)</li> <li>• LC41 (Operation equivalent to C241)</li> <li>• LC44 (Operation equivalent to C244)</li> <li>• LC46 (Operation equivalent to C246)</li> <li>• LC47 (Operation equivalent to C247)</li> <li>• LC49 (Operation equivalent to C249)</li> <li>• LC51 (Operation equivalent to C251)</li> <li>• LC52 (Operation equivalent to C252)</li> <li>• LC54 (Operation equivalent to C254)</li> </ul> CH2 <ul style="list-style-type: none"> <li>• LC36 (Operation equivalent to C236)</li> </ul> CH3 <ul style="list-style-type: none"> <li>• LC37 (Operation equivalent to C237)</li> <li>• LC42 (Operation equivalent to C242)</li> <li>• LC45 (Operation equivalent to C245)</li> </ul> CH4 <ul style="list-style-type: none"> <li>• LC38 (Operation equivalent to C238)</li> <li>• LC48 (Operation equivalent to C248)</li> <li>• LC50 (Operation equivalent to C250)</li> <li>• LC53 (Operation equivalent to C253)</li> <li>• LC55 (Operation equivalent to C255)</li> <li>• LC48 (Operation equivalent to C248(OP))</li> <li>• LC53 (Operation equivalent to C253(OP))</li> </ul> CH5 <ul style="list-style-type: none"> <li>• LC39 (Operation equivalent to C239)</li> <li>• LC43 (Operation equivalent to C243)</li> </ul> CH6 <ul style="list-style-type: none"> <li>• LC40 (Operation equivalent to C240)</li> </ul> CH7 <ul style="list-style-type: none"> <li>• LC44 (Operation equivalent to C244(OP))</li> <li>• LC54 (Operation equivalent to C254(OP))</li> </ul>	—
Counter device	Select the high speed counter of input assignment which is compatible with FX3.	CH8 <ul style="list-style-type: none"> <li>• LC45 (Operation equivalent to C245(OP))</li> </ul>	—
Operation Mode	Not available for FX3-compatible high-speed counters.	—	—
Pulse Input Mode	Set pulse input mode.	<ul style="list-style-type: none"> <li>• 2 Phase 1 Multiple</li> <li>• 2 Phase 4 Multiple</li> </ul>	—
Preset Input Enable/Disable	Not available for FX3-compatible high-speed counters	—	—



Item	Description	Setting range	Default
Input logic	Sets preset input logic when preset input is enabled.	<ul style="list-style-type: none"> <li>• Positive Logic</li> <li>• Negative Logic</li> </ul>	—
Preset Value	Not available for FX3-compatible high-speed counters.	—	—
Input Comparison Enable/Disable	Sets whether to "enable" or "disable" input comparison when preset input is enabled.	<ul style="list-style-type: none"> <li>• Disable</li> <li>• Enable</li> </ul>	—
Control Switch	Sets preset execution timing when preset input is enabled.	<ul style="list-style-type: none"> <li>• Rising</li> <li>• Falling</li> <li>• Rising + Falling Edge</li> <li>• Always During Input ON</li> </ul>	—
Enable Input Enable/Disable	Not available for FX3-compatible high-speed counters	—	—
Input logic			
Ring Length Enable/Disable			
Ring Length			
Measurement Unit Time			
No. of Pulse per Rotation			

**Point** 

Parameters are enabled when the CPU module is powered ON or after a reset.

## Special relays/LC devices capable of high-speed transfers with the HCMOV/DHCMOV instruction

Shown below are the special relay/LC device that can read and write the latest value with the HCMOV/DHCMOV instruction when the FX3 compatible high-speed counter function is valid. When special relays and LC devices are specified for (s) and (d) of instructions other than the HCMOV/DHCMOV instruction, the operation is the same as that of the MOV/DMOV instruction.

The same operation as when the FX3 compatible high-speed counter is not valid is made for the special relay/special register capable of high-speed transfers with the HCMOV/DHCMOV instruction other than those described in the list below. (  Page 280 Special relays/special registers capable of high-speed transfers with the HCMOV/DHCMOV instruction)

### Special relay

- : High-speed transfer capable (special relay is immediately updated)
- △: Normal transfer capable (special relay is updated in END processing)
- ×: Transfer not possible (read-only)

Special relay	Function	Compatible with HCMOV/DHCMOV instruction		Compatible with MOV/DMOV instruction	
		(s)	(d)	(s)	(d)
SM8246	LC46 counting direction monitoring	○	×	△	×
SM8247	LC47 counting direction monitoring	○	×	△	×
SM8248	LC48 counting direction monitoring	○	×	△	×
SM8249	LC49 counting direction monitoring	○	×	△	×
SM8250	LC50 counting direction monitoring	○	×	△	×
SM8251	LC51 counting direction monitoring	○	×	△	×
SM8252	LC52 counting direction monitoring	○	×	△	×
SM8253	LC53 counting direction monitoring	○	×	△	×
SM8254	LC54 counting direction monitoring	○	×	△	×
SM8255	LC55 counting direction monitoring	○	×	△	×

## LC device

○: High-speed transfer capable (special register is immediately updated)

△: Normal transfer capable (special register is updated in END processing)

×: Transfer not possible (read-only)

LC device	Function	Compatible with DHCMOV instruction		Compatible with DMOV instruction	
		(s)	(d)	(s)	(d)
LC35	High-speed counter current value (CH1)	○	○	△	×
LC36	High-speed counter current value (CH2)	○	○	△	×
LC37	High-speed counter current value (CH3)	○	○	△	×
LC38	High-speed counter current value (CH4)	○	○	△	×
LC39	High-speed counter current value (CH5)	○	○	△	×
LC40	High-speed counter current value (CH6)	○	○	△	×
LC41	High-speed counter current value (CH1)	○	○	△	×
LC42	High-speed counter current value (CH3)	○	○	△	×
LC43	High-speed counter current value (CH5)	○	○	△	×
LC44	High-speed counter current value (CH1)/High-speed counter current value (CH7)	○	○	△	×
LC45	High-speed counter current value (CH3)/High-speed counter current value (CH8)	○	○	△	×
LC46	High-speed counter current value (CH1)	○	○	△	×
LC47	High-speed counter current value (CH1)	○	○	△	×
LC48	High-speed counter current value (CH4)	○	○	△	×
LC49	High-speed counter current value (CH1)	○	○	△	×
LC50	High-speed counter current value (CH4)	○	○	△	×
LC51	High-speed counter current value (CH1)	○	○	△	×
LC52	High-speed counter current value (CH1)	○	○	△	×
LC53	High-speed counter current value (CH4)	○	○	△	×
LC54	High-speed counter current value (CH1)/High-speed counter current value (CH7)	○	○	△	×
LC55	High-speed counter current value (CH4)	○	○	△	×

## Precautions when using FX3-compatible high-speed counters

Shown below are the precautions for using the FX3 compatible high-speed counter. For any other precautions, see the precautions for each function.

- When the FX3 compatible function is valid, it is possible to specify the LC device in (s1) of the DHSCS instruction/DHSCR instruction and (s) of the DHSZ instruction. If an LC device that is not used as high-speed counter is specified, an error occurs, and the DHSCS instruction, the DHSCR instruction, and the DHSZ instruction do not operate.
- Set up the table with the CH number of the counter if the table number of the high-speed comparison table/the multi-point output high-speed comparison table needs to be specified.
- To clear the current value of the LC device, use the DHCMOV instruction or the RST instruction to clear it.
- Use the latch setting to use LC35 to LC55 with the high-speed counter of the FX3 compatible function.
- The reset coil of the LC device is cleared when the power is set from OFF to ON.
- For the functions that share inputs with FX3-compatible high-speed counter function, refer to  Page 285 Functions that share inputs and outputs.

## 26.3 Pulse Width Measurement Function

This section describes the pulse width measurement function.

### Pulse width measurement function overview

Pulse width/period measurement of up to 12 channels is possible from the CPU module and the high-speed pulse input/output module. The pulse width/period measurement function stores the values of 0.5  $\mu\text{s}$  ring counters at the input signal rising edge and falling edge to special data registers. This function also stores the difference in the counter values (pulse width) between the rising edge and the falling edge or stores the difference in the counter values (cycle) between the previous rising edge and the current rising edge to special data registers in units of 0.5  $\mu\text{s}$ .

For the pulse width measurement function, input channel assignments, logical switch, and measurement mode settings are configured with parameters, and measurements are started/stopped using the HIOEN/DHIOEN instruction.

High-speed pulse input/output module is supported only for FX5UJ and FX5U/FX5UC CPU modules.

26

#### Point

To use the pulse width measurement function, parameter settings and the HIOEN/DHIOEN instruction are always required.

### Pulse width measurement specifications

This section describes the pulse width measurement function specifications.

#### Pulse input signals

##### ■FX5S CPU module

Pulse width measurements can be used for a maximum of 4 channels.

The input device assignment is as follows. (fixed)

CPU module			
CH1	CH2	CH3	CH4
X0	X1	X3	X4

The table below shows the measurement frequencies.

CPU module	Measurement frequencies
X0, X1, X3, X4	100 kHz

The table below shows the measurement precision.

Item	Description	
Possible measurement range	Cycle	10 $\mu\text{s}$
	Pulse width	10 $\mu\text{s}$
Maximum measurable signal width	1073s741ms823 $\mu\text{s}$	
Resolution	0.5 $\mu\text{s}$	

##### ■FX5UJ CPU module and high-speed pulse I/O module

Pulse width measurements can be used for a maximum of 12 channels. (CPU module 4CH + high-speed pulse input/output module 2CH  $\times$  4 modules)

The input device assignment is as follows. (Fixed for CPU modules)

CPU module				High-speed pulse I/O module*1							
				First module		Second module		Third module		Fourth module	
CH1	CH2	CH3	CH4	CH5	CH6	CH7	CH8	CH9	CH10	CH11	CH12
X0	X1	X3	X4	X□+3	X□+4	X□+3	X□+4	X□+3	X□+4	X□+3	X□+4

\*1 The number in □ is the head input number for each high-speed pulse input/output module.

The table below shows the measurement frequencies.

- FX5UJ CPU module

CPU module	Measurement frequencies
X0, X1, X3, X4	100 kHz

- High-speed pulse input/output module

High-speed pulse input/output module*2	Measurement frequencies
X□+3, X□+4	200 kHz

\*2 The number in □ is the head input number for each high-speed pulse input/output module.

The table below shows the measurement precision.

- FX5UJ CPU module

Item	Description	
Possible measurement range	Cycle	10 μs
	Pulse width	10 μs
Maximum measurable signal width	1073s741ms823μs	
Resolution	0.5 μs	

- High-speed pulse input/output module

Item	Description	
Possible measurement range	Cycle	5 μs
	Pulse width	5 μs
Maximum measurable signal width	1073s741ms823μs	
Resolution	0.5 μs	

## ■FX5U/FX5UC CPU module and high-speed pulse input/output module

Pulse width measurements can be used for a maximum of 12 channels. (CPU module 4CH + high-speed pulse input/output module 2CH × 4 modules)

The input device assignment is as follows.

CPU module				High-speed pulse input/output module*1							
				First module		Second module		Third module		Fourth module	
CH1	CH2	CH3	CH4	CH5	CH6	CH7	CH8	CH9	CH10	CH11	CH12
X0 to X7 (Any device can be set.)				X□+3	X□+4	X□+3	X□+4	X□+3	X□+4	X□+3	X□+4

\*1 The number in □ is the head input number for each high-speed pulse input/output module.

The table below shows the measurement frequencies.

FX5U-32M□, FX5UC-32M□	FX5U-64M□, FX5U-80M□, FX5UC-64M□, FX5UC-96M□	High-speed pulse input/output module*2	Measurement frequencies
X0 to X5	X0 to X7	X□+3, X□+4	200 kHz
X6 to X7	—	—	10 kHz

\*2 The number in □ is the head input number for each high-speed pulse input/output module.

The table below shows the measurement precision.

Item	Description	
Possible measurement range	Cycle	5 μs
	Pulse width	5 μs
Maximum measurable signal width	1073s741ms823μs	
Resolution	0.5 μs	

## Pulse measurements

The pulse width and period are stored in special devices by the END instruction. (☞ Page 772 Special Relay List)

## Pulse width maximum value and minimum value

The maximum value and minimum value of the pulse width from the start of measurements are stored in special devices.

(☞ Page 772 Special Relay List)

## Period maximum value and minimum value

The maximum value and minimum value of the period from the start of measurements are stored in special devices.

([Page 772 Special Relay List](#))

## Switching positive logic/negative logic

The pulse input logic can be switched.

Positive logic or negative logic can be set for each channel with parameter settings.

### ■ Operation for positive logic

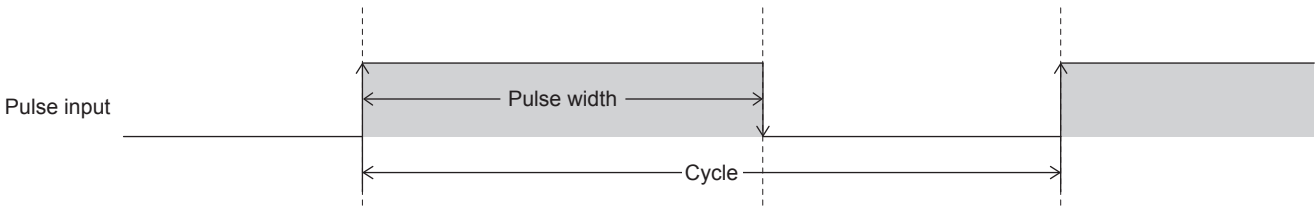

### ■ Operation for negative logic

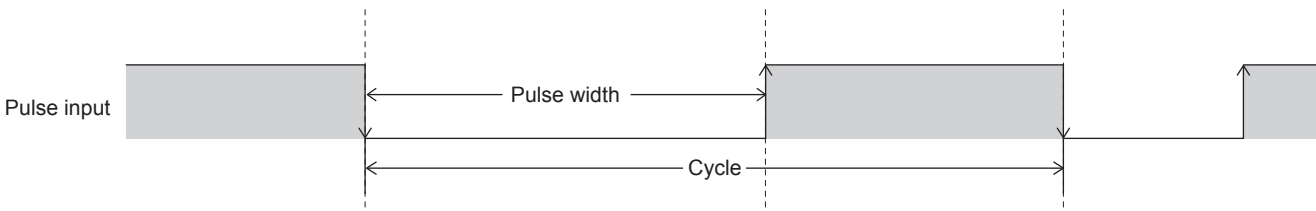

## Continuous measurement/one-time measurement mode

The pulse width measurement mode can be set.

The table below shows the measurement modes for pulse width measurements.

Mode	Description
1 time measurement mode	Measures the pulse width and period only once from the start of the measurement.
Always measurement mode	Constantly measures the pulse width and period.



The measurement mode can be changed by using a special relay. ([Page 772 Special Relay List](#))

## Signal delay time measurement

In a user program, the delay time between signals can be calculated from the rising or falling ring counters of 2 inputs.

([Page 306 Examples of program](#))

# Pulse measurement function execution procedure

The pulse measurement function execution procedure is shown below.

## 1. Check the pulse measurement specifications.

Check the specifications such as the measurement frequency of pulse measurements. (☞ Page 297 Pulse width measurement specifications)

## 2. Connect the CPU module to the external device.

For details on wiring to external devices, refer to the following manual  
 ☞ MELSEC iQ-F FX5S/FX5UJ/FX5U/FX5UC User's Manual (Hardware)

## 3. Set the parameters.

Configure the parameters such as the pulse measurement channel settings. (☞ Page 300 Pulse width measurement parameters)

## 4. Create the program.

Create the program for using pulse measurements.

## 5. Run the program.

# Pulse width measurement parameters

This section explains the parameters for pulse width measurement.

Set the parameters for pulse width measurement in GX Works3.

## Outline of parameters

Parameters for pulse width measurement are input allocation, logical switch, measurement modes and input response time.

## Parameter setting

The following explains how to set the parameters for pulse width measurement.

For input response time, refer to ☞ Page 316 General-purpose Input Functions.

### ■CPU module

☞ Navigation window ⇒ [Parameter] ⇒ [Module model name] ⇒ [Module Parameter] ⇒ [High Speed I/O] ⇒ "Input Function" ⇒ "Pulse Width Measurement" ⇒ "Detailed Setting"

### Window

Item	CH1	CH2	CH3	CH4
<b>Use Pulse Width Measurement</b>	<b>Set whether to use pulse width measurement or not.</b>			
Use/Not Use	Enable	Enable	Enable	Disable
<b>Input Signal</b>	<b>Set input signal.</b>			
Input Signal	X0	X1	X3	X0
<b>Switch Logic</b>	<b>Set switching logic.</b>			
Switch Logic	Positive Logic	Negative Logic	Positive Logic	Positive Logic
<b>Measurement Mode</b>	<b>Set measurement mode.</b>			
Measurement Mode	Always Measurement Mode	1 Time Measurement Mode	1 Time Measurement Mode	Always Measurement Mode

### Displayed items

Item	Description	Setting range	Default
Use Pulse Width Measurement	Set whether to use pulse width measurement or not.	<ul style="list-style-type: none"> <li>Disable</li> <li>Enable</li> </ul>	Disable
Input Signal	Set input signal.	<ul style="list-style-type: none"> <li>■FX5S/FX5UJ CPU module CH1 (X0), CH2 (X1), CH3 (X3), CH4 (X4)</li> <li>■FX5U/FX5UC CPU module X0 to X7</li> </ul>	—
Logical Switch	Set logical switch.	<ul style="list-style-type: none"> <li>Positive Logic</li> <li>Negative Logic</li> </ul>	—
Measurement Mode	Set measurement mode.	<ul style="list-style-type: none"> <li>Always Measurement Mode</li> <li>1 Time Measurement Mode</li> </ul>	—

### ■High-speed pulse input/output module

Add the high-speed pulse input/output module.

Navigation window ⇒ [Parameter] ⇒ [Module Information] ⇒ Right-click ⇒ Add New Module

After adding the high-speed pulse input/output module, make settings on the screen displayed from the following operation.

Navigation window ⇒ [Parameter] ⇒ [Module Information] ⇒ [1 to 16 (high-speed pulse input/output module)] ⇒ [Module Parameter] ⇒ [High Speed I/O] ⇒ "Input Function" ⇒ "Pulse Width Measurement" ⇒ "Detailed Setting"

### Window

Item	CH5	CH6
<b>Use Pulse Width Measurement</b>	<b>Set whether to use pulse width measurement or not.</b>	
Use/Not Use	Enable	Enable
<b>Input Signal</b>	<b>Set input signal.</b>	
Input Signal	X23	X24
<b>Switch Logic</b>	<b>Set switching logic.</b>	
Switch Logic	Positive Logic	Negative Logic
<b>Measurement Mode</b>	<b>Set measurement mode.</b>	
Measurement Mode	Always Measurement Mode	1 Time Measurement Mode

Shown above is the screen at the time when the first high-speed pulse input/output module is selected.

### Displayed items

Item	Description	Setting range	Default
Use Pulse Width Measurement	Set whether to use pulse width measurement or not.	<ul style="list-style-type: none"> <li>• Disable</li> <li>• Enable</li> </ul>	Disable
Input Signal	Use input signal. The input number is fixed for each channel.	<ul style="list-style-type: none"> <li>• CH□: X<math>\blacksquare</math>+3<sup>*1</sup></li> <li>• CH□+1: X<math>\blacksquare</math>+4<sup>*1</sup></li> </ul>	—
Logical Switch	Set logical switch.	<ul style="list-style-type: none"> <li>• Positive Logic</li> <li>• Negative Logic</li> </ul>	—
Measurement Mode	Set measurement mode.	<ul style="list-style-type: none"> <li>• Always Measurement Mode</li> <li>• 1 Time Measurement Mode</li> </ul>	—

\*1 The number in □ is first module: 5, second module: 7, third module: 9, fourth module: 11.  
The number in  $\blacksquare$  is the head input number for each high-speed pulse input/output module.

### Point

Parameters are enabled when the CPU module is powered ON or after a reset.

## Details of special relays/special registers

Details of special relays/special registers used in pulse width measurement are explained below.

### Pulse width measurement status flag

This flag is a device for monitoring the measurement in progress/measurement stopped status of pulse width measurement.

### ■Corresponding devices

The device numbers corresponding to each channel are as follows.

CPU module				High-speed pulse input/output module							
				First module		Second module		Third module		Fourth module	
CH1	CH2	CH3	CH4	CH5	CH6	CH7	CH8	CH9	CH10	CH11	CH12
SM5020	SM5021	SM5022	SM5023	SM5024	SM5025	SM5026	SM5027	SM5028	SM5029	SM5030	SM5031

### ■Update timing

This device turns ON when the HIOEN/DHIOEN instruction is executed. It turns OFF at the END instruction when the measurement mode is the 1 time measurement mode.

### ■Clear timing

The timing when the device is cleared is as follows.

- Power OFF→ON
- Reset
- STOP/PAUSE→RUN
- RUN→STOP/PAUSE
- When measurement is stopped by the HIOEN/DHIOEN instruction

### Period measurement complete

This flag turns ON at the end of the 1st period measurement. During measurement in the always measurement mode, it stays ON.

### ■Corresponding devices

The device numbers corresponding to each channel are as follows.

CPU module				High-speed pulse input/output module							
				First module		Second module		Third module		Fourth module	
CH1	CH2	CH3	CH4	CH5	CH6	CH7	CH8	CH9	CH10	CH11	CH12
SM5036	SM5037	SM5038	SM5039	SM5040	SM5041	SM5042	SM5043	SM5044	SM5045	SM5046	SM5047

### ■Update timing

Devices are updated by the END instruction.

### ■Clear timing

The timing when the device is cleared is as follows.

- Power OFF→ON
- Reset
- STOP/PAUSE→RUN
- The first END instruction after measurement is started by the HIOEN/DHIOEN instruction



When the HCMOV/DHCMOV instruction is used, the latest value can be read.

### Pulse width measurement complete

This flag turns ON at the end of the 1st pulse width measurement. During measurement in the always measurement mode, it stays ON.

### ■Corresponding devices

The device numbers corresponding to each channel are as follows.

CPU module				High-speed pulse input/output module							
				First module		Second module		Third module		Fourth module	
CH1	CH2	CH3	CH4	CH5	CH6	CH7	CH8	CH9	CH10	CH11	CH12
SM5052	SM5053	SM5054	SM5055	SM5056	SM5057	SM5058	SM5059	SM5060	SM5061	SM5062	SM5063

### ■Update timing

Devices are updated by the END instruction.

### ■Clear timing

The timing when the device is cleared is as follows.

- Power OFF→ON
- Reset
- STOP/PAUSE→RUN
- The first END instruction after measurement is started by the HIOEN/DHIOEN instruction



When the HCMOV/DHCMOV instruction is used, the latest value can be read.



## Measurement mode

The measurement mode can be checked. The measurement mode can also be changed by turning special relays ON/OFF.

OFF: Always measurement mode

ON: 1 time measurement mode

### Point

Measurement mode is applied when measurement is started by the HIOEN/DHIOEN instruction.

If the measurement mode is changed during measurement, operation in the measurement mode after the change begins when the next measurement is started.

### ■Corresponding devices

The device numbers corresponding to each channel are as follows.

CPU module				High-speed pulse input/output module							
				First module		Second module		Third module		Fourth module	
CH1	CH2	CH3	CH4	CH5	CH6	CH7	CH8	CH9	CH10	CH11	CH12
SM5068	SM5069	SM5070	SM5071	SM5072	SM5073	SM5074	SM5075	SM5076	SM5077	SM5078	SM5079

### ■Clear timing

The timing when the device is cleared is as follows.

- Power OFF→ON
- Reset
- STOP/PAUSE→RUN

## Rising edge ring counter value

The ring counter value when the rising edge is detected is stored.

### ■Corresponding devices

The device numbers corresponding to each channel are as follows.

CPU module				High-speed pulse input/output module							
				First module		Second module		Third module		Fourth module	
CH1	CH2	CH3	CH4	CH5	CH6	CH7	CH8	CH9	CH10	CH11	CH12
SD5021, SD5020	SD5041, SD5040	SD5061, SD5060	SD5081, SD5080	SD5101, SD5100	SD5121, SD5120	SD5141, SD5140	SD5161, SD5160	SD5181, SD5180	SD5201, SD5200	SD5221, SD5220	SD5241, SD5240

### ■Update timing

Devices are updated by the END instruction.

### ■Clear timing

The timing when the device is cleared is as follows.

- Power OFF→ON
- Reset
- STOP/PAUSE→RUN

## Falling edge ring counter value

The ring counter value when the falling edge is detected is stored.

### ■Corresponding devices

The device numbers corresponding to each channel are as follows.

CPU module				High-speed pulse input/output module							
				First module		Second module		Third module		Fourth module	
CH1	CH2	CH3	CH4	CH5	CH6	CH7	CH8	CH9	CH10	CH11	CH12
SD5023, SD5022	SD5043, SD5042	SD5063, SD5062	SD5083, SD5082	SD5103, SD5102	SD5123, SD5122	SD5143, SD5142	SD5163, SD5162	SD5183, SD5182	SD5203, SD5202	SD5223, SD5222	SD5243, SD5242

## Update timing, clear timing

Same as the rising edge ring counter value (Page 303 Rising edge ring counter value)

## Pulse width latest value

The latest value of the pulse width is stored.

### Point

- When logic switching is set to positive logic, the difference from the rising edge up to the falling edge.
- When logic switching is set to negative logic, the difference from the falling edge up to the rising edge.

## Corresponding devices

The device numbers corresponding to each channel are as follows.

CPU module				High-speed pulse input/output module							
				First module		Second module		Third module		Fourth module	
CH1	CH2	CH3	CH4	CH5	CH6	CH7	CH8	CH9	CH10	CH11	CH12
SD5025, SD5024	SD5045, SD5044	SD5065, SD5064	SD5085, SD5084	SD5105, SD5104	SD5125, SD5124	SD5145, SD5144	SD5165, SD5164	SD5185, SD5184	SD5205, SD5204	SD5225, SD5224	SD5245, SD5244

## Update timing, clear timing

Same as the rising edge ring counter value (Page 303 Rising edge ring counter value)

## Pulse width maximum value

The maximum value of the pulse width is stored.

### Point

- When logic switching is set to positive logic, the difference from the rising edge up to the falling edge.
- When logic switching is set to negative logic, the difference from the falling edge up to the rising edge.
- The maximum value of the pulse width can be changed only by the HCMOV/DHCMOV instruction.

## Corresponding devices

The device numbers corresponding to each channel are as follows.

CPU module				High-speed pulse input/output module							
				First module		Second module		Third module		Fourth module	
CH1	CH2	CH3	CH4	CH5	CH6	CH7	CH8	CH9	CH10	CH11	CH12
SD5027, SD5026	SD5047, SD5046	SD5067, SD5066	SD5087, SD5086	SD5107, SD5106	SD5127, SD5126	SD5147, SD5146	SD5167, SD5166	SD5187, SD5186	SD5207, SD5206	SD5227, SD5226	SD5247, SD5246

## Update timing

Devices are updated by the END instruction.

When the HCMOV/DHCMOV instruction is executed, devices are updated immediately.

## Clear timing

The timing when the device is cleared is as follows.

- Power OFF→ON
- Reset
- STOP/PAUSE→RUN
- When "0" is written by the HCMOV/DHCMOV instruction

## Pulse width minimum value

The minimum value of the pulse width is stored.

### Point

- When logic switching is set to positive logic, the difference from the rising edge up to the falling edge.
- When logic switching is set to negative logic, the difference from the falling edge up to the rising edge.
- The minimum value of the pulse width can be changed only by the HCMOV/DHCMOV instruction.

### ■Corresponding devices

The device numbers corresponding to each channel are as follows.

CPU module				High-speed pulse input/output module							
				First module		Second module		Third module		Fourth module	
CH1	CH2	CH3	CH4	CH5	CH6	CH7	CH8	CH9	CH10	CH11	CH12
SD5029, SD5028	SD5049, SD5048	SD5069, SD5068	SD5089, SD5088	SD5109, SD5108	SD5129, SD5128	SD5149, SD5148	SD5169, SD5168	SD5189, SD5188	SD5209, SD5208	SD5229, SD5228	SD5249, SD5248

### ■Update timing, clear timing

Same as the pulse width maximum value (☞ Page 304 Pulse width maximum value)

### Period latest value

The latest value of the period is stored.

#### Point

- When logic switching is set to positive logic, the difference from the previous rising edge up to the latest rising edge.
- When logic switching is set to negative logic, the difference from the previous falling edge up to the latest falling edge.

### ■Corresponding devices

The device numbers corresponding to each channel are as follows.

CPU module				High-speed pulse input/output module							
				First module		Second module		Third module		Fourth module	
CH1	CH2	CH3	CH4	CH5	CH6	CH7	CH8	CH9	CH10	CH11	CH12
SD5031, SD5030	SD5051, SD5050	SD5071, SD5070	SD5091, SD5090	SD5111, SD5110	SD5131, SD5130	SD5151, SD5150	SD5171, SD5170	SD5191, SD5190	SD5211, SD5210	SD5231, SD5230	SD5251, SD5250

### ■Update timing, clear timing

Same as the rising edge ring counter value (☞ Page 303 Rising edge ring counter value)

### Period maximum value

The maximum value of the period is stored.

#### Point

- When logic switching is set to positive logic, the difference from rising edge to rising edge.
- When logic switching is set to negative logic, the difference from the previous falling edge up to the latest falling edge.
- The maximum value of the period can be changed only by the HCMOV/DHCMOV instruction.

### ■Corresponding devices

The device numbers corresponding to each channel are as follows.

CPU module				High-speed pulse input/output module							
				First module		Second module		Third module		Fourth module	
CH1	CH2	CH3	CH4	CH5	CH6	CH7	CH8	CH9	CH10	CH11	CH12
SD5033, SD5032	SD5053, SD5052	SD5073, SD5072	SD5093, SD5092	SD5113, SD5112	SD5133, SD5132	SD5153, SD5152	SD5173, SD5172	SD5193, SD5192	SD5213, SD5212	SD5233, SD5232	SD5253, SD5252

### ■Update timing, clear timing

Same as the pulse width maximum value (☞ Page 304 Pulse width maximum value)

## Period minimum value

The minimum value of the period is stored.

### Point

- When logic switching is set to positive logic, the difference from rising edge to rising edge.
- When logic switching is set to negative logic, the difference from the previous falling edge up to the latest falling edge.
- The minimum value of the period can be changed only by the HCMOV/DHCMOV instruction.

## ■Corresponding devices

The device numbers corresponding to each channel are as follows.

CPU module				High-speed pulse input/output module							
				First module		Second module		Third module		Fourth module	
CH1	CH2	CH3	CH4	CH5	CH6	CH7	CH8	CH9	CH10	CH11	CH12
SD5035, SD5034	SD5055, SD5054	SD5075, SD5074	SD5095, SD5094	SD5115, SD5114	SD5135, SD5134	SD5155, SD5154	SD5175, SD5174	SD5195, SD5194	SD5215, SD5214	SD5235, SD5234	SD5255, SD5254

## ■Update timing, clear timing

Same as the pulse width maximum value (  Page 304 Pulse width maximum value)

## Cautions when using the pulse width measurement function

- When the HCMOV/DHCMOV instruction is used, the latest ring counter value, pulse width, cycle, maximum value, and minimum value can be obtained.
- The measurement mode can be changed using the special relays. Note, however, that the measurement mode cannot be changed during pulse width measurement. To change the measurement mode, stop pulse width measurement, change the measurement mode and then resume measurement.
- Pulse measurement is possible only while in RUN status. Pulse width measurement is stopped by RUN→PAUSE and RUN→STOP.
- In a program with interruption priority 1, the HIOEN/DHIOEN instruction cannot be executed to start or stop pulse width measurement of the high-speed pulse input/output module.
- In a program with interruption priority 1, HCMOV/DHCMOV instruction specified with the following devices for the high-speed input/output module cannot be executed.
  - Period measurement complete
  - Pulse width measurement complete
  - Rising edge ring counter value
  - Falling edge ring counter value
  - Pulse width latest value
  - Pulse width maximum value
  - Pulse width minimum value
  - Period latest value
  - Period maximum value
  - Period minimum value
- For functions that share inputs with the pulse width measurement function, refer to  Page 285 Functions that share inputs and outputs.

## Examples of program

An example of a program using the pulse width measurement function is explained below.

## Outline of operation

A program for measuring the delay time between the rising edges of input signals X1 and X2 on the FX5U CPU module is explained below.

## Parameter setting

This program assumes that parameters are set as follows.

Input signals X1 and X2 are assigned to CH1 (X1) and CH2 (X2) by parameters. CH3 and CH4 need not be set.

Item	CH to be used	
	CH1	CH2
Input signal	X1	X2
Input logic switching	Positive logic	Positive logic
Measurement mode	Always measurement mode	Always measurement mode

## Program

An operation diagram and program are shown below.

### ■ Operation diagram

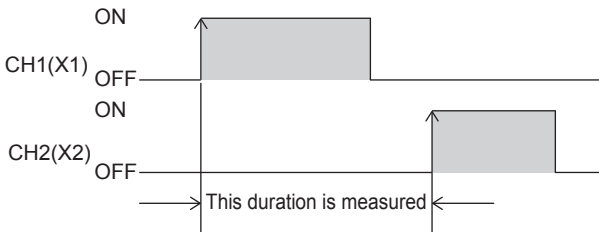

### ■ Program

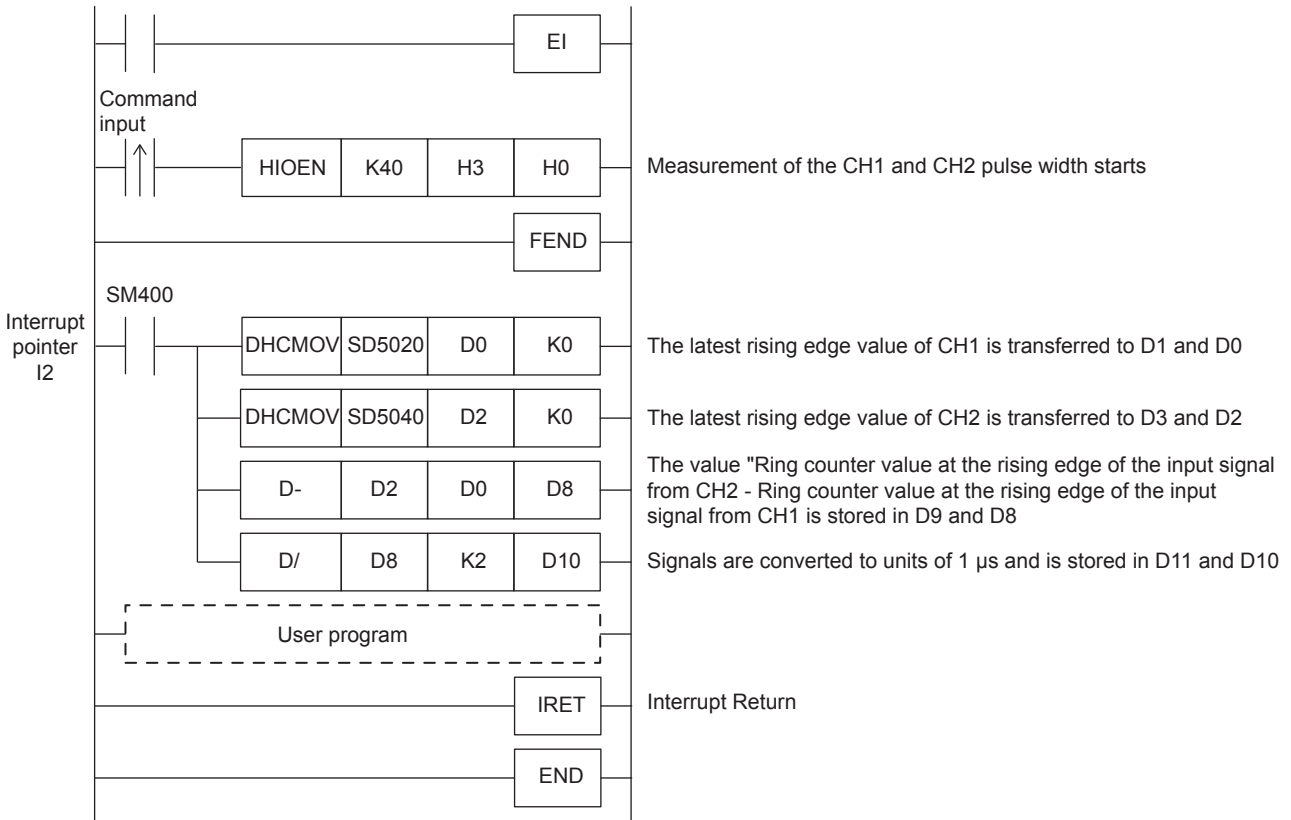

## Precautions

If high-speed pulse input/output module operates in an interrupt program with the priority 1, operation error (3580H) occurs.

The high-speed pulse input/output module operates in an interrupt program with the priority 2 or 3.

# 26.4 Pulse Catch Function

This section explains the pulse catch function.

## Outline of pulse catch function

The pulse catch function enables pulse signals that are incompletely sampled in regular input processing to be caught. Inputs X0 to X17 on the CPU module and all inputs on the high-speed pulse input/output module can be used on up to 40 channels (CPU module: 8 points, high-speed pulse input/output module 8 points × 4 modules).

To use the pulse catch function, pulse catch setting and the input response time must be set with parameters.

An FX3-compatible pulse catch function is mounted on only the CPU module. For details of functions, refer to  Page 313 FX3-compatible Pulse Catch Function.



The pulse catch function and FX3-compatible pulse catch function can be used simultaneously.

## Specifications of pulse catch function

The specifications of the pulse catch function are explained below.

### Performance specifications

Pulse catches can be used on inputs X0 to X17 of the CPU module and all inputs on the high-speed pulse input/output module.

#### ■FX5S CPU module

- Input response time

Input response times are shown below.

FX5S-30M□, FX5S-40M□, FX5S-60M□, FX5S-80M□	Input response time
X0, X1, X3, X4	10 μs
X2, X5, X6, X7	100 μs
X10 to X17	200 μs

- Detectable pulse width

Pulse widths that satisfy the following condition can be detected.

Pulse input ON width > input response time

#### ■FX5UJ CPU module and high-speed pulse I/O module

- Input response time

Input response times are shown below.

FX5UJ-24M□	FX5UJ-40M□, FX5UJ-60M□	High-speed pulse I/O module *1	Input response time
X0, X1, X3, X4	X0, X1, X3, X4	X□ to X□+5	10μs
X2, X5, X6, X7	X2, X5, X6, X7	X□+6, X□+7	100μs
X10 to X15	X10 to X17	—	200 μs

\*1 The number in □ is the head input number for each high-speed pulse input/output module.

- Detectable pulse width

Pulse widths that satisfy the following condition can be detected.

Pulse input ON width > input response time

## ■FX5U/FX5UC CPU module and high-speed pulse input/output module

- Input response time

Input response times are shown below.

FX5U-32M□, FX5UC-32M□	FX5U-64M□, FX5U-80M□, FX5UC-64M□, FX5UC-96M□	High-speed pulse input/output module*1	Input response time
X0 to X5	X0 to X7	X□ to X□+5	5 μs
X6 to X17	X10 to X17	X□+6, X□+7	100 μs

\*1 The number in □ is the head input number for each high-speed pulse input/output module.

- Detectable pulse width

Pulse widths that satisfy the following condition can be detected.

Pulse input ON width > input response time



Pulses cannot be detected normally if the above condition is not satisfied. Set the input response time so that the above condition is satisfied.

## Pulse catch function execution procedure

The procedure for executing the pulse catch function is explained below.

1. Check the pulse catch specifications.

Check specifications such as the input response time of the pulse catch. (☞ Page 308 Specifications of pulse catch function)

2. Connect the CPU module to the external device.

For details on wiring to external devices, refer to the following manual

📖 MELSEC iQ-F FX5S/FX5UJ/FX5U/FX5UC User's Manual (Hardware)

3. Set the parameters.

Set the pulse catch setting and other parameters. (☞ Page 309 Pulse catch parameters)

4. Create the program.

5. Run the program.

## Pulse catch parameters

This section explains the pulse catch parameters.

Set the pulse catch parameters in GX Works3.

### Outline of parameters

Pulse catch parameters are pulse catch setting and input response time.

## Parameter setting

This section explains how to set pulse catch parameters.

For input response time, refer to  Page 316 General-purpose Input Functions.

### ■CPU module

 Navigation window ⇒ [Parameter] ⇒ [Module model name] ⇒ [Module Parameter] ⇒ [High Speed I/O] ⇒ "Input Function" ⇒ "General/Interrupt/Pulse Catch" ⇒ "Detailed Setting"

#### Window

No.	XY Signal	General/Interrupt/Pulse Catch
1	X0	Interrupt (Rising) + Pulse Catch
2	X1	General-purpose Input
3	X2	General-purpose Input
4	X3	General-purpose Input
5	X4	General-purpose Input
6	X5	General-purpose Input
7	X6	General-purpose Input
8	X7	General-purpose Input
9	X10	General-purpose Input
10	X11	General-purpose Input
11	X12	General-purpose Input
12	X13	General-purpose Input
13	X14	General-purpose Input
14	X15	General-purpose Input
15	X16	General-purpose Input
16	X17	General-purpose Input

#### Displayed items

Item	Description	Setting range	Default
General/Interrupt/Pulse Catch	Set the function to be used. Set to "Interrupt (Rising) + Pulse Catch".	<ul style="list-style-type: none"> <li>General-purpose Input</li> <li>Interrupt (Rising)</li> <li>Interrupt (Falling)</li> <li>Interrupt (Rising + Falling)</li> <li>Interrupt (Rising) + Pulse Catch</li> </ul>	General-purpose Input

### ■High-speed pulse input/output module

Add the high-speed pulse input/output module.

High-speed pulse input/output module is supported for FX5UJ/FX5U/FX5UC CPU modules.

 Navigation window ⇒ [Parameter] ⇒ [Module Information] ⇒ Right-click ⇒ Add New Module

After adding the high-speed pulse input/output module, make settings on the screen displayed from the following operation.

 Navigation window ⇒ [Parameter] ⇒ [Module Information] ⇒ [1 to 16 (high-speed pulse input/output module)] ⇒ [Module Parameter] ⇒ "Input Function" ⇒ "General/Interrupt/Pulse Catch" ⇒ "Detailed Setting"

#### Window

No.	XY Signal	General/Interrupt/Pulse Catch	Interrupt Pointer
1	X20	Interrupt (Rising) + Pulse Catch	
2	X21	General-purpose Input	
3	X22	General-purpose Input	
4	X23	General-purpose Input	
5	X24	General-purpose Input	
6	X25	General-purpose Input	
7	X26	General-purpose Input	
8	X27	General-purpose Input	

Shown above is the screen at the time when the first high-speed pulse input/output module is selected.



## Displayed items

Item	Description	Setting range	Default
General/Interrupt/Pulse Catch	Set the function to be used. Set to "Interrupt (Rising) + Pulse Catch".	<ul style="list-style-type: none"> <li>• General-purpose Input</li> <li>• Interrupt (Rising)</li> <li>• Interrupt (Falling)</li> <li>• Interrupt (Rising + Falling)</li> <li>• Interrupt (Rising) + Pulse Catch</li> </ul>	General-purpose Input
Interrupt Pointer	Set the interrupt pointer (I) which is assigned to each input. The pulse catch function does not use an interrupt pointer.	I50 to I177	—

### Point

Parameters are enabled when the CPU module is powered ON or after a reset.

## Operation of pulse catch function

Operation of the pulse catch function is explained below.

### Basic operation of pulse catch function

The corresponding input device is turned ON for the duration of the scan following the scan where the pulse signal is detected. The input device is turned OFF at the END instruction.

#### ■ Operation when input signal is used as pulse catch function

The rising edge of the external input signal (X0) is detected, and the input device is turned ON only during the following scan.

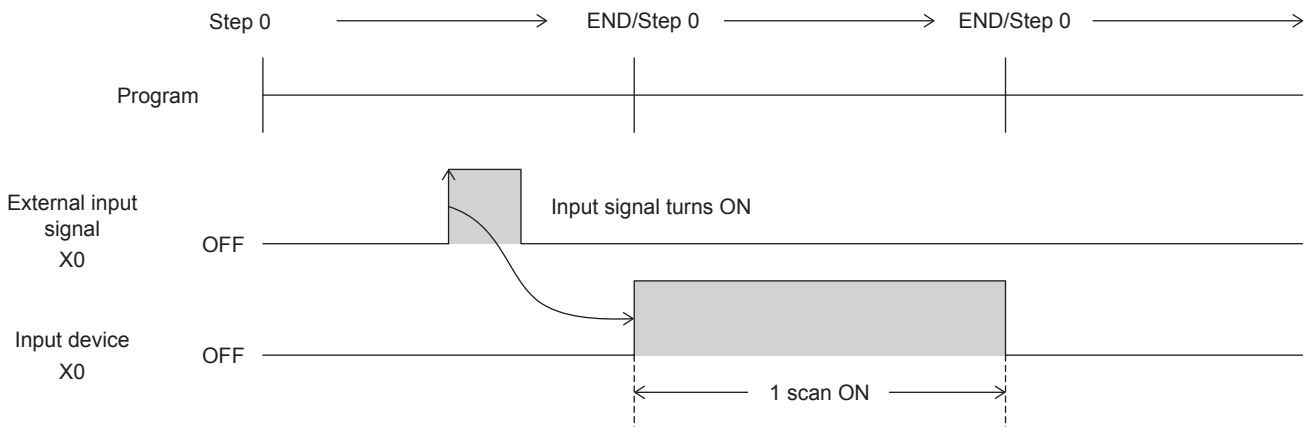

#### ■ Operation when multiple pulses are detected within one scan

The second pulse onwards is ignored. Input pulse signals at intervals of one scan or longer.

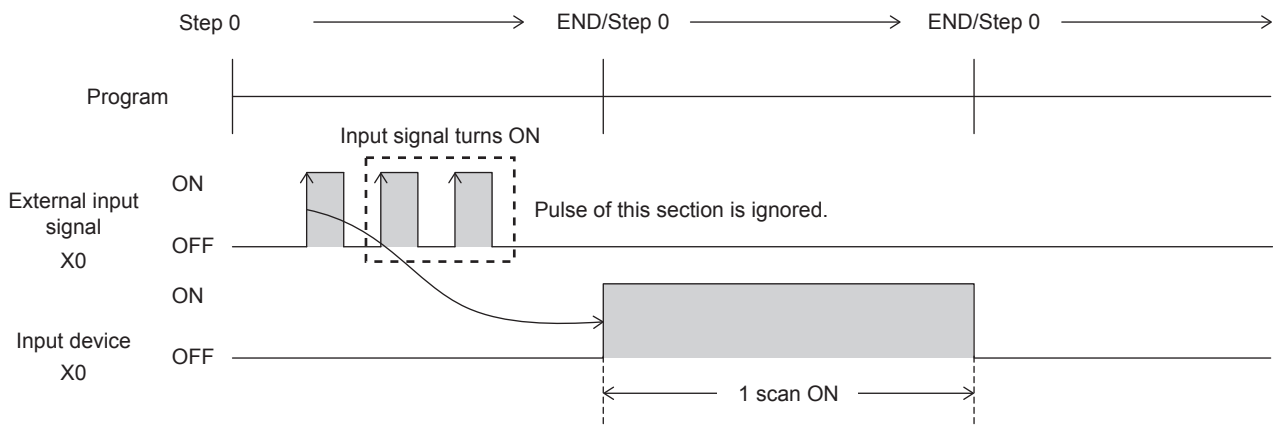

### ■ Operation when the same pulse is detected for two scans or more

The input device is turned ON for the detected number of scans. Input pulse signals at intervals of one scan or longer.

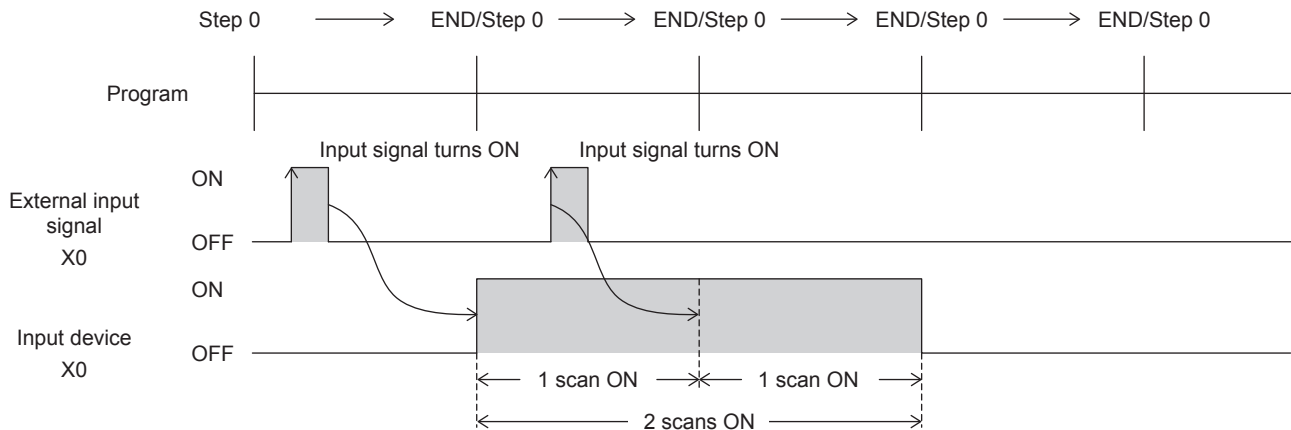

### ■ Operation when a pulse having an ON width of two scans or more is input

The input device is turned ON for one scan only.

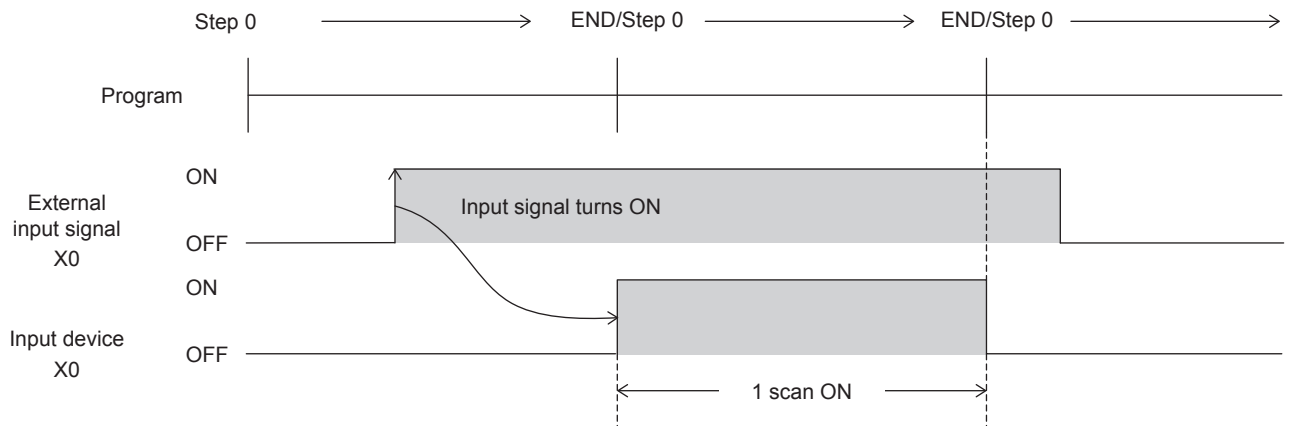

## Cautions when using the pulse catch function

- The pulse catch function operates only when "Interrupt (Rising) + Pulse Catch" is set with parameters.
- The pulse catch function can be used on inputs X0 to X17 on the CPU module. Note, however, that these inputs can be used on up to 8 points.
- For the functions that share inputs with pulse catch function, refer to [Page 285 Functions that share inputs and outputs](#). Do not perform the following on inputs for which the pulse catch function is selected. Doing so results in the input device not turning ON normally in one scan after the pulse is detected.
  - Use of direct device (DX)
  - Execution of input refreshing during execution of the REF, RFS, MTR instructions, etc.

# 26.5 FX3-compatible Pulse Catch Function

This section explains the FX3-compatible pulse catch function.

## Outline of FX3-compatible pulse catch function

An FX3-compatible pulse catch function is mounted on the CPU module, When the input signal X0 to X7 turns OFF→ON, a special relay (SM8170 to SM8177) is immediately set to ON by interrupt processing. Use of these special relays in a normal sequence program enables pulse signals that are incompletely sampled in regular input processing to be caught.

To use the FX3-compatible pulse catch function, pulse catch setting and the input response time must be set with parameters. Functions equivalent to the MELSEC Q/L series pulse catch function are also mounted. For details of functions, refer to  Page 308 Pulse Catch Function.

### Point

The pulse catch function and FX3-compatible pulse catch function can be used simultaneously.

## Specifications of FX3-compatible pulse catch function

This specifications of the FX3-compatible pulse catch function are explained below.

### Performance specifications

FX3-compatible pulse catches can be used on inputs X0 to X7.

#### ■FX5S/FX5UJ CPU module

- Input response time

Input response times are shown below.

FX5S/FX5UJ CPU module	Input response time
X0, X1, X3, X4	10 μs
X2, X5, X6, X7	100 μs

- Assignment of input numbers and special relays

The assignments of input numbers and special relays are explained below.

Input number	Corresponding special relay
X0	SM8170
X1	SM8171
X2	SM8172
X3	SM8173
X4	SM8174
X5	SM8175
X6	SM8176
X7	SM8177

#### ■FX5U/FX5UC CPU module

- Input response time

Input response times are shown below.

FX5U-32M□, FX5UC-32M□	FX5U-64M□, FX5U-80M□, FX5UC-64M□, FX5UC-96M□	Input response time
X0 to X5	X0 to X7	5 μs
X6 to X7	—	100 μs

- Assignment of input numbers and special relays

The assignments of input numbers and special relays are explained below.

Input number	Corresponding special relay
X0	SM8170
X1	SM8171
X2	SM8172
X3	SM8173
X4	SM8174
X5	SM8175
X6	SM8176
X7	SM8177

## FX3-compatible pulse catch function execution procedure

The procedure for executing the FX3-compatible pulse catch function is explained below.

1. Check the FX3-compatible pulse catch specifications.

Check specifications such as the input response time and corresponding special relay of the FX3-compatible pulse catch.

( Page 313 Specifications of FX3-compatible pulse catch function)

2. Connect the CPU module to the external device.

For details on wiring to external devices, refer to the following manual

 MELSEC iQ-F FX5S/FX5UJ/FX5U/FX5UC User's Manual (Hardware)

3. Set the parameters.

Set the pulse catch setting and other parameters. ( Page 314 FX3-compatible pulse catch parameters)

4. Create the program.

Create the program for using pulse catch.

5. Run the program.

## FX3-compatible pulse catch parameters

This section explains the FX3-compatible pulse catch parameters.

Set the FX3-compatible pulse catch parameters in GX Works3.

### Outline of parameters

FX3-compatible pulse catch parameters are pulse catch setting and input response time.

For input response time, refer to  Page 316 General-purpose Input Functions.

### Parameter setting

This section explains how to set FX3-compatible pulse catch parameters.

#### ■CPU module

 Navigation window ⇒ [Parameter] ⇒ [Module model name] ⇒ [Module Parameter] ⇒ [High Speed I/O] ⇒ "Input Function" ⇒ "General/Interrupt/Pulse Catch" ⇒ "Detailed Setting"

#### Window

No.	XY Signal	General/Interrupt/Pulse Catch
1	X0	Interrupt (Rising) + Pulse Catch
2	X1	General-purpose Input
3	X2	General-purpose Input
4	X3	General-purpose Input
5	X4	General-purpose Input
6	X5	General-purpose Input
7	X6	General-purpose Input
8	X7	General-purpose Input

## Displayed items

Item	Description	Setting range	Default
General/Interrupt/Pulse Catch	Set the function to be used. Set to "Interrupt (Rising)" or "Interrupt (Rising) + Pulse Catch".	<ul style="list-style-type: none"> <li>• General-purpose Input</li> <li>• Interrupt (Rising)</li> <li>• Interrupt (Falling)</li> <li>• Interrupt (Rising + Falling)</li> <li>• Interrupt (Rising) + Pulse Catch</li> </ul>	General-purpose Input

### Point

Parameters are enabled when the CPU module is powered ON or after a reset.

## Operation of FX3-compatible pulse catch function

Operation of the FX3-compatible pulse catch function is explained below.

### Operation of FX3-compatible pulse catch function

When the status of the input (X0 to X7) changes OFF→ON, a special relay (SM8170 to SM8177) is immediately set to ON by interrupt processing. Pulse catch operates even when an input interrupt is also set in duplicate with other functions. Note, however, that the pulse catch must be set with parameters.

#### Examples of program

When the status of the X0 changes OFF→ON, SM8170 is immediately set to ON by interrupt processing. To capture input again, turn X2 ON to reset SM8170. (X0 is assumed to be set with parameters.)

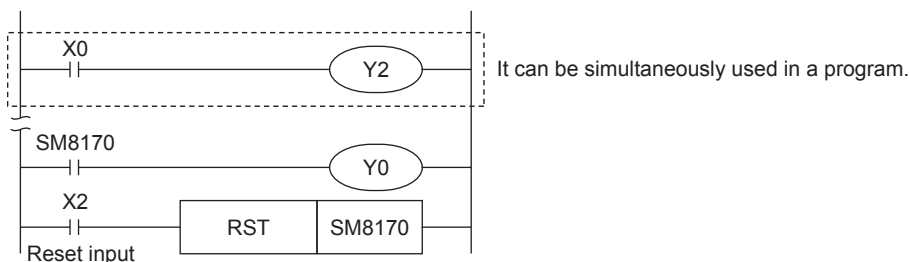

#### Operation diagram

An operation diagram of the above program example is shown below.

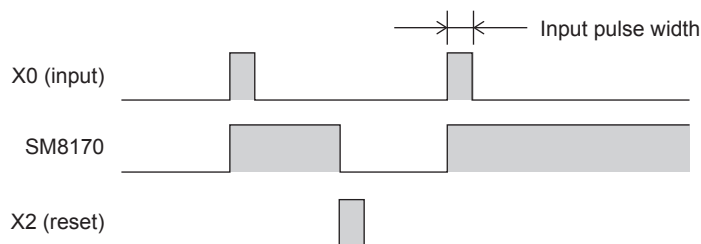

## Cautions when using the FX3-compatible pulse catch function

- The FX3-compatible pulse catch function operates only when "Interrupt (Rising)" or "Interrupt (Rising) + Pulse Catch" is set with parameters.
- To capture input again, the special relay that is set must be reset by the program. Accordingly, new input cannot be captured until the special relay that is set is reset.
- The special relays for FX3-compatible pulse catch are cleared at STOP→RUN and a reset.
- The FX3-compatible pulse catch function is executed regardless of the operations of the special relays for disabling interrupts.
- The FX3-compatible pulse catch function is executed regardless of the operations of the EI, DI instruction.
- For the functions that share inputs with FX3-compatible pulse catch function, refer to [Page 285 Functions that share inputs and outputs.](#)

# 26.6 General-purpose Input Functions

The FX5 PLC general-purpose inputs are explained below.

## Outline of general-purpose input functions

For general-purpose inputs of the FX5 PLC, the input response time can be set by parameters.

## Specifications of general-purpose inputs

### Performance specifications

Input response times can be set to general-purpose inputs.

#### ■FX5S CPU module

- Input response time setting

Input response times that can be set are shown below. The default value is 10 ms.

Input number set value	Input response time set value
X0 to X17	No Setting, 10 $\mu$ s, 50 $\mu$ s, 0.1ms, 0.2ms, 0.4ms, 0.6ms, 1ms, 5ms, 10ms, 20ms, 70ms

#### Point

- The value obtained by adding on the value of the hardware filter is the actual input response time.
- The input response time of X20 or later for the CPU module is invalid.

- Hardware filter value

The delay times of the hardware filter on the CPU module and high-speed pulse I/O module are shown below.

Input number	Hardware filter value	
	ON	OFF
<b>FX5S-30M□, FX5S-40M□, FX5S-60M□, FX5S-80M□</b>		
X0, X1, X3, X4	5 $\mu$ s	5 $\mu$ s
X2, X5, X6, X7	30 $\mu$ s	50 $\mu$ s
X10 to X17	50 $\mu$ s	150 $\mu$ s
X20 or later	10ms or less	10ms or less

- Input response time setting units

The following table lists the units (1 point unit/8 point unit) that can be set for the input response time of each CPU module.

CPU module	X0 to X7	X10 to X17
FX5S CPU module	1 point unit/8 points units	1 point unit/8 points units

#### ■FX5UJ CPU module

- Input response time setting

Input response times that can be set are shown below. The default value is 10 ms.

Input number set value	Input response time set value
X0 to X377	No Setting, 10 $\mu$ s, 50 $\mu$ s, 0.1 ms, 0.2 ms, 0.4 ms, 0.6 ms, 1 ms, 5 ms, 10 ms, 20 ms, 70 ms

#### Point

- The value obtained by adding on the value of the hardware filter is the actual input response time.
- The input response time of X20 or later for the CPU module is invalid.

- Hardware filter value

The delay times of the hardware filter on the CPU module and high-speed pulse input/output module are shown below. The hardware filter value of I/O modules is 50 $\mu$ s when the value is on, and 150 $\mu$ s when the value is off.

Input number		Hardware filter value	
FX5UJ-24M□	FX5UJ-40M□, FX5UJ-60M□	ON	OFF
X0, X1, X3, X4	X0, X1, X3, X4	5 $\mu$ s	5 $\mu$ s
X2, X5, X6, X7	X2, X5, X6, X7	30 $\mu$ s	50 $\mu$ s
X10 to X15	X10 to X17	50 $\mu$ s	150 $\mu$ s
—	X20 or later	Approx. 10ms	Approx. 10ms

- Input response time setting units

The following table lists the units (1 point unit/8 point unit) that can be set for the input response time of each CPU module.

CPU module	X0 to X7	X10 to X17
FX5UJ CPU module	1 point unit/8 points units	1 point unit/8 points units

### ■FX5U/FX5UC CPU module

- Input response time setting

Input response times that can be set are shown below. The default value is 10 ms.

Input number set value	Input response time set value
X0 to X577	No Setting, 10 $\mu$ s, 50 $\mu$ s, 0.1 ms, 0.2 ms, 0.4 ms, 0.6 ms, 1 ms, 5 ms, 10 ms, 20 ms, 70 ms



The value obtained by adding on the value of the hardware filter is the actual input response time.

- Hardware filter value

The delay times of the hardware filter on the CPU module and high-speed pulse input/output module are shown below. The hardware filter value of I/O modules is 50 $\mu$ s when the value is on, and 150 $\mu$ s when the value is off.

Input number		Hardware filter value	
FX5U-32M□, FX5UC-32M□	FX5U-64M□, FX5U-80M□, FX5UC-64M□, FX5UC-96M□	ON	OFF
X0 to X5	X0 to X7	2.5 $\mu$ s	2.5 $\mu$ s
X6 to X17	X10 to X17	30 $\mu$ s	50 $\mu$ s
—	X20 or later	50 $\mu$ s	150 $\mu$ s

- Input response time setting units

The following table lists the units (1 point unit/8 point unit) that can be set for the input response time of each CPU module.

CPU module	X0 to X7	X10 to X17	X20 to X27	X30 to X37	X40 to X47	X50 to X57
FX5U-32M□, FX5UC-32M□	1 point unit/8 points units	1 point unit/8 points units	—	—	—	—
FX5U-64M□, FX5UC-64M□	1 point unit/8 points units	1 point unit/8 points units	1 point unit/8 points units	1 point unit/8 points units	—	—
FX5U-80M□	1 point unit/8 points units	1 point unit/8 points units	1 point unit/8 points units	1 point unit/8 points units	8 points units <sup>*1</sup>	—
FX5UC-96M□	1 point unit /8 point units	1 point unit /8 point units	1 point unit /8 point units	1 point unit /8 point units	8 point units <sup>*1</sup>	8 point units <sup>*2</sup>

\*1 When 1 point unit is set for the input response time using GX Works3, X41 to X47 operate with the input response time set to X40.

\*2 When 1 point unit is set for the input response time using GX Works3, X51 to X57 operate with the input response time set to X50.

## High-speed pulse input/output module

- Input response time setting

Input response times that can be set are shown below. The default value is 10 ms.

Input number set value	Input response time set value
X0 to X577	No Setting, 10 μs, 50 μs, 0.1 ms, 0.2 ms, 0.4 ms, 0.6 ms, 1 ms, 5 ms, 10 ms, 20 ms, 70 ms

### Point

The value obtained by adding on the value of the hardware filter is the actual input response time.

- Hardware filter value

The delay time of the hardware filter of the high-speed pulse input/output module is shown below.

The hardware filter value of I/O modules is 50μs when the value is on, and 150μs when the value is off.

Input number	Hardware filter value	
	ON	OFF
<b>High-speed pulse input/output module*1</b>		
X□ to X□+5	2.5 μs	2.5 μs
X□+6, X□+7	30 μs	50 μs

\*1 The number in □ is the head input number for each high-speed pulse input/output module.

- Input response time setting units

All the points of the high-speed pulse input/output module are in the unit of one point or 8 points.

## General-purpose input function parameters

This section explains the general-purpose input parameters.

Set the input response time parameters in GX Works3.

### Parameter setting

This section explains how to set the input response time parameters. Set the input response time.

Navigation window ⇒ [Parameter] ⇒ [Module model name] ⇒ [Module Parameter] ⇒ [Input Response Time]

### Window

Item	Setting
<b>X0-X7</b>	<b>Specify the input response time of X0 to X7.</b>
Response Type	High-Speed
X0	10ms
X1	10ms
X2	10ms
X3	10ms
X4	10ms
X5	10ms
X6	10ms
X7	10ms
<b>X10-X17</b>	<b>Specify the input response time of X10 to X17.</b>
Response Type	Normal
X10	10ms
X11	10ms
X12	10ms
X13	10ms
X14	10ms
X15	10ms
X16	10ms
X17	10ms



## Displayed items

Item	Description	Setting range	Default
Response Type	Select the input response time between 1 point unit and 8 point unit. High-Speed: 1 point unit Normal: 8 point units	<ul style="list-style-type: none"> <li>High-Speed</li> <li>Normal</li> </ul>	—
<ul style="list-style-type: none"> <li>■FX5S CPU module                             <ul style="list-style-type: none"> <li>• X0 to X17</li> </ul> </li> <li>■FX5UJ CPU module                             <ul style="list-style-type: none"> <li>• X0 to X377</li> </ul> </li> <li>■FX5U/FX5UC CPU module                             <ul style="list-style-type: none"> <li>• X0 to X577</li> </ul> </li> </ul>	Set the input response time.	<ul style="list-style-type: none"> <li>No Setting</li> <li>10 μs</li> <li>50 μs</li> <li>0.1ms</li> <li>0.2ms</li> <li>0.4ms</li> <li>0.6ms</li> <li>1ms</li> <li>5ms</li> <li>10ms</li> <li>20ms</li> <li>70ms</li> </ul>	10ms

### Point

Parameters are enabled when the CPU module is powered ON or after a reset.

## 26.7 PWM Function

This chapter explains the PWM function.

### Outline of PWM output

The CPU module and the high-speed pulse input/output module allow PWM output on up to 12 channels.

For PWM output, the output channel assignment, pulse/cycle units, output pulse logic, pulse width, cycle, etc. are set using parameters, and the HIOEN/DHIOEN instruction is used to start/stop pulse output.

Also, the regular PWM/DPWM instruction can be used.

High-speed pulse input/output module is supported only for FX5UJ and FX5U/FX5UC CPU modules.

### PWM output specifications

The PWM output specifications are explained below.

#### Number of output channels

##### ■FX5S CPU module

Up to 4 channels can be used for PWM output.

The output device assignment is as follows.

CPU module			
CH1	CH2	CH3	CH4
Y0 to Y7 (Any device can be set.)			

## ■FX5UJ/FX5U/FX5UC CPU module and high-speed pulse input/output module

Up to 12 channels (CPU module 4CH + high-speed pulse input/output module 2CH × 4 modules) can be used for PWM output.

The output device assignment is as follows.

CPU module				High-speed pulse input/output module*1							
				First module		Second module		Third module		Fourth module	
CH1	CH2	CH3	CH4	CH5	CH6	CH7	CH8	CH9	CH10	CH11	CH12
Y0 to Y7 (Any device can be set.)				Y□+1	Y□+5	Y□+1	Y□+5	Y□+1	Y□+5	Y□+1	Y□+5



Outputs (Y) assigned for PWM output in parameter settings cannot be used by the positioning function.

\*1 The number in □ is the head output number for each high-speed pulse input/output module.

## Setting range of period and pulse width

The setting values that can be set for cycle and pulse width are shown below.

### ■FX5S CPU module

Output number	Period		Pulse width	
	1 ms units	1 μs units	1 ms units	1 μs units
Y0 to Y3	1 to 2147483 ms	10 to 2147483647 μs	1 to 2147483 ms	5 to 2147483647 μs
Y4 to Y7	1 to 2147483 ms	400 to 2147483647 μs	1 to 2147483 ms	200 to 2147483647 μs

### ■FX5UJ CPU module

Output number	Period		Pulse width	
	1 ms units	1 μs units	1 ms units	1 μs units
Y0 to Y2	1 to 2147483 ms	5 to 2147483647 μs	1 to 2147483 ms	2 to 2147483647 μs
Y3 to Y7	1 to 2147483 ms	400 to 2147483647 μs	1 to 2147483 ms	200 to 2147483647 μs

### ■FX5U/FX5UC CPU module

Output number	Period		Pulse width	
	1 ms units	1 μs units	1 ms units	1 μs units
Y0 to Y3	1 to 2147483 ms	1 to 2147483647 μs	1 to 2147483 ms	1 to 2147483647 μs
Y4 to Y7	1 to 2147483 ms	400 to 2147483647 μs	1 to 2147483 ms	200 to 2147483647 μs

### ■High-speed pulse input/output module

Output number	Period		Pulse width	
	1 ms units	1 μs units	1 ms units	1 μs units
High-speed pulse input/output module*1				
Y□+1, Y□+5	1 to 2147483 ms	1 to 2147483647 μs	1 to 2147483 ms	1 to 2147483647 μs

\*1 The number in □ is the head output number for each high-speed pulse input/output module.

The response time for actual output varies depending on the connected load. Check the output specifications of the module that uses PWM outputs. For the output specifications, refer to the manual of each module.

## Relationship between cycle and pulse width

The relationship between period and pulse width is shown below.

### ■When positive logic is set

The relationship between the period and pulse width when the output pulse logic at start of pulse output is set to "Positive Logic" is shown below. (The pulse width is called the "ON width".)

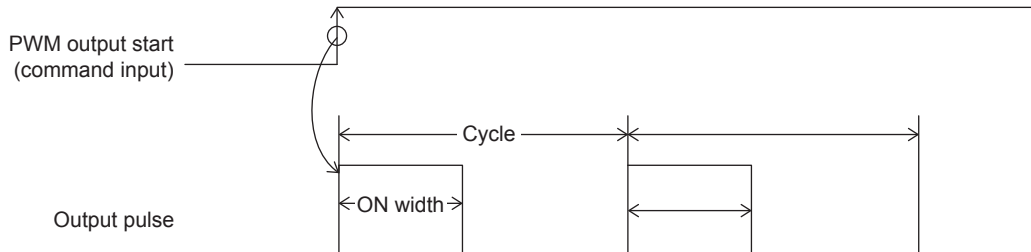

#### Point

- When positive logic is set, PWM output begins from output ON.)
- Pulse output is stopped at the specified number of pulses.
- Pulse output stops in the output (Y) status of before PWM output was started.

### ■When negative logic is set

The relationship between the period and pulse width when the output pulse logic at start of pulse output is set to "Negative Logic" is shown below. (The pulse width is called the "OFF width".)

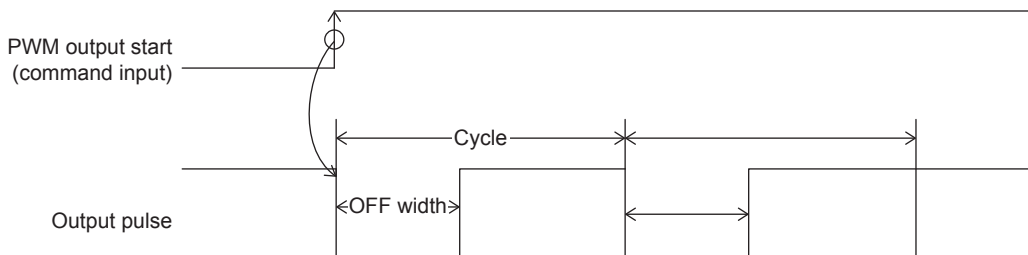

#### Point

- When negative logic is set, PWM output begins when the output pulse turns OFF.
- Pulse output is stopped at the specified number of pulses.
- Pulse output stops in the output (Y) status of before PWM output was started.

## PWM driving method

PWM output is driven by either of the following methods.

### ■Driven by HIOEN/DHIOEN instruction

The logical settings like output destination, cycle, pulse width, output pulse logic, etc. are set in parameters, and the HIOEN/DHIOEN instruction is used to execute pulse output. For parameters, refer to [Page 322 PWM output parameters](#).

For the HIOEN/DHIOEN instruction, refer to [MELSEC iQ-F FX5 Programming Manual \(Instructions, Standard Functions/Function Blocks\)](#).

### ■Driven by PWM/DPWM instruction

The PWM/DPWM instruction is used to execute pulse output.

For the PWM/DPWM instruction, refer to [MELSEC iQ-F FX5 Programming Manual \(Instructions, Standard Functions/Function Blocks\)](#).

# PWM output function execution procedure

The procedure for executing the PWM output function is explained below.

## 1. Check the specifications of PWM output.

Check specifications such as pulse output performance of PWM output. (Page 319 PWM output specifications)

## 2. Connect the CPU module to the external device.

For details on wiring to external devices, refer to the following manual

MELSEC iQ-F FX5S/FX5UJ/FX5U/FX5UC User's Manual (Hardware)

## 3. Set the parameters.

Set the output destination, cycle, pulse width, output pulse logic, etc. of the PWM in parameters, (Page 322 PWM output parameters)

## 4. Create the program.

Create the program for using PWM output.

## 5. Run the program.

# PWM output parameters

This section explains the PWM output parameters.

Set the PWM output parameters in GX Works3.

## Outline of parameters

PWM output parameters are output destination, pulse width/cycle unit, output pulse logic, pulse width, and period.

## Parameter setting

This section explains how to set the PWM output parameters.

Set the output destination, pulse width/cycle unit, output pulse logic, pulse width, period, etc. of the channel to be used.

### ■CPU module

Navigation window ⇒ [Parameter] ⇒ [Module model name] ⇒ [Module Parameter] ⇒ [High Speed I/O] ⇒ "Output Function" ⇒ "PWM" ⇒ "Detailed Setting"

### Window

Item	CH1	CH2	CH3	CH4
<b>Use PWM Output</b>	<b>Set whether to use PWM output or not.</b>			
Use/Not Use	Enable	Enable	Disable	Enable
<b>Output Signal</b>	<b>Set the output destination device.</b>			
Output Signal	Y0	Y1	Y0	Y3
<b>Pulse Width/Cycle Unit</b>	<b>Set pulse width/cycle unit.</b>			
Pulse Width/Cycle Unit	1ms	1micro-s	1ms	1ms
<b>Output Pulse Logic</b>	<b>Set output pulse logic.</b>			
Output Pulse Logic	Positive Logic	Positive Logic	Positive Logic	Negative Logic
<b>Pulse Width</b>	<b>Set pulse width.</b>			
Pulse Width	10 ms	100 micro-s	1 ms	200 ms
<b>Cycle</b>	<b>Set cycle.</b>			
Cycle	20 ms	500 micro-s	1 ms	300 ms

## Displayed items

Item	Description	Setting range	Default
Use PWM Output	Set whether to use PWM output or not.	<ul style="list-style-type: none"> <li>• Disable</li> <li>• Enable</li> </ul>	Disable
Output Signal	Set the output destination device of output signal.	Y0 to Y7	—
Pulse Width/Cycle Unit	Set pulse width/cycle unit.	<ul style="list-style-type: none"> <li>• 1 ms</li> <li>• 1 μs</li> </ul>	—
Output Pulse Logic	Sets output pulse logic.	<ul style="list-style-type: none"> <li>• Positive Logic</li> <li>• Negative Logic</li> </ul>	—
Pulse Width	Sets the ON/OFF width of the pulse.	<p>■FX5S CPU module</p> <ul style="list-style-type: none"> <li>• When pulse width/period unit is set to 1 ms Y0 to Y3: 1 to 2147483ms Y4 to Y7: 1 to 2147483ms</li> <li>• When pulse width/period unit is set to 1 μs Y0 to Y3: 5 to 2147483647 μs Y4 to Y7: 200 to 2147483647 μs</li> </ul> <p>■FX5UJ CPU module</p> <ul style="list-style-type: none"> <li>• When pulse width/period unit is set to 1 ms Y0 to Y2: 1 to 2147483ms Y3 to Y7: 1 to 2147483ms</li> <li>• When pulse width/period unit is set to 1 μs Y0 to Y2: 2 to 2147483647 μs Y3 to Y7: 200 to 2147483647 μs</li> </ul> <p>■FX5U/FX5UC CPU module</p> <ul style="list-style-type: none"> <li>• When pulse width/period unit is set to 1 ms Y0 to Y3: 1 to 2147483ms Y4 to Y7: 1 to 2147483ms</li> <li>• When pulse width/period unit is set to 1 μs Y0 to Y3: 2 to 2147483647 μs Y4 to Y7: 200 to 2147483647 μs</li> </ul>	—
Cycle	Sets cycle.	<p>■FX5S CPU module</p> <ul style="list-style-type: none"> <li>• When pulse width/period unit is set to 1 ms Y0 to Y3: 1 to 2147483ms Y4 to Y7: 1 to 2147483ms</li> <li>• When pulse width/period unit is set to 1 μs Y0 to Y3: 10 to 2147483647 μs Y4 to Y7: 400 to 2147483647 μs</li> </ul> <p>■FX5UJ CPU module</p> <ul style="list-style-type: none"> <li>• When pulse width/period unit is set to 1 ms Y0 to Y2: 1 to 2147483ms Y3 to Y7: 1 to 2147483ms</li> <li>• When pulse width/period unit is set to 1 μs Y0 to Y2: 5 to 2147483647 μs Y3 to Y7: 400 to 2147483647 μs</li> </ul> <p>■FX5U/FX5UC CPU module</p> <ul style="list-style-type: none"> <li>• When pulse width/period unit is set to 1 ms Y0 to Y3: 1 to 2147483ms Y4 to Y7: 1 to 2147483ms</li> <li>• When pulse width/period unit is set to 1 μs Y0 to Y3: 5 to 2147483647 μs Y4 to Y7: 400 to 2147483647 μs</li> </ul>	—

## ■High-speed pulse input/output module

Add the high-speed pulse input/output module.

Navigation window ⇒ [Parameter] ⇒ [Module Information] ⇒ Right-click ⇒ Add New Module

After adding the high-speed pulse input/output module, make settings on the screen displayed from the following operation.

Navigation window ⇒ [Parameter] ⇒ [Module Information] ⇒ [1 to 16 (high-speed pulse input/output module)] ⇒ [Module Parameter] ⇒ "Output Function" ⇒ "PWM" ⇒ "Detail Setting"

### Window

Item	CH5	CH6
<b>Use PWM Output</b>	<b>Set whether to use PWM output or not.</b>	
Use/Not Use	Enable	Enable
<b>Output Signal</b>	<b>Set the output destination device.</b>	
Output Signal	Y21	Y25
<b>Pulse Width/Cycle Unit</b>	<b>Set pulse width/cycle unit.</b>	
Pulse Width/Cycle Unit	1ms	1micro-s
<b>Output Pulse Logic</b>	<b>Set output pulse logic.</b>	
Output Pulse Logic	Positive Logic	Negative Logic
<b>Pulse Width</b>	<b>Set pulse width.</b>	
Pulse Width	100 ms	300 micro-s
<b>Cycle</b>	<b>Set cycle.</b>	
Cycle	500 ms	1000 micro-s

Shown above is the screen at the time when the first high-speed pulse input/output module is selected.

### Displayed items

Item	Description	Setting range	Default
Use PWM Output	Set whether to use PWM output or not.	<ul style="list-style-type: none"> <li>• Disable</li> <li>• Enable</li> </ul>	Disable
Output Signal	The output destination device of output signal. The output number is fixed for each channel.	<ul style="list-style-type: none"> <li>• CH□: Y■+1<sup>*1</sup></li> <li>• CH□+1: Y■+5<sup>*1</sup></li> </ul>	—
Pulse Width/Cycle Unit	Set pulse width/cycle unit.	<ul style="list-style-type: none"> <li>• 1ms</li> <li>• 1 μs</li> </ul>	—
Output Pulse Logic	Sets output pulse logic.	<ul style="list-style-type: none"> <li>• Positive Logic</li> <li>• Negative Logic</li> </ul>	—
Pulse Width	Sets the ON/OFF width of the pulse.	<ul style="list-style-type: none"> <li>• When pulse width/period unit is set to 1 ms 1 to 2147483 ms</li> <li>• When pulse width/period unit is set to 1 μs 1 to 2147483647 μs</li> </ul>	—
Cycle	Sets cycle.	<ul style="list-style-type: none"> <li>• When pulse width/cycle unit is set to 1 ms 1 to 2147483 ms</li> <li>• When pulse width/period unit is set to 1 μs 1 to 2147483647 μs</li> </ul>	—

\*1 The number in □ is first module: 5, second module: 7, third module: 9, fourth module: 11.  
The number in ■ is the head output number for each high-speed pulse input/output module.

### Point

The items specified in the parameters are stored in special devices when the CPU module is set from STOP to RUN.

# Details of special relays/special registers

Details of special relays/special registers used in PWM output are explained below.

## Operation monitor

This device is for monitoring the operation/stopped status of PWM output.

### ■Corresponding devices

The device numbers corresponding to each channel are as follows.

CPU module				High-speed pulse input/output module							
				First module		Second module		Third module		Fourth module	
CH1	CH2	CH3	CH4	CH5	CH6	CH7	CH8	CH9	CH10	CH11	CH12
SM5300	SM5301	SM5302	SM5303	SM5304	SM5305	SM5306	SM5307	SM5308	SM5309	SM5310	SM5311

### ■Update timing

The timing of device update is as follows.

ON	OFF
<ul style="list-style-type: none"> <li>• PWM output driven by HIOEN/DHIOEN instruction</li> <li>• PWM/DPWM instruction ON execution</li> </ul>	<ul style="list-style-type: none"> <li>• PWM output stopped by HIOEN/DHIOEN instruction</li> <li>• After end of output of the specified number of pulses</li> <li>• PWM/DPWM instruction OFF execution</li> <li>• Activation contact turned OFF</li> <li>• Power OFF→ON, reset, RUN→STOP/PAUSE</li> </ul>

## PWM output complete flag

This device is for monitoring the completion status (normal completion) of PWM output.

### ■Corresponding devices

The device numbers corresponding to each channel are as follows.

CPU module				High-speed pulse input/output module							
				First module		Second module		Third module		Fourth module	
CH1	CH2	CH3	CH4	CH5	CH6	CH7	CH8	CH9	CH10	CH11	CH12
SM5316	SM5317	SM5318	SM5319	SM5320	SM5321	SM5322	SM5323	SM5324	SM5325	SM5326	SM5327

### ■Update timing

The timing of device update is as follows.

ON	OFF
<ul style="list-style-type: none"> <li>• At execution of the PWM/DPWM, HIOEN/DHIOEN instruction or the END processing after the output of the specified pulse count is output</li> </ul>	<ul style="list-style-type: none"> <li>• Power OFF→ON, reset, STOP/PAUSE→RUN</li> <li>• When pulse output starts</li> <li>• When turned OFF by the user</li> </ul>



If the number of output pulses is set to "0" (unlimited output), PWM output complete flag is not turned ON.

## PWM output abnormal end flag

This device is for monitoring the end status (abnormal end) of PWM output.

### ■Corresponding devices

The device numbers corresponding to each channel are as follows.

CPU module				High-speed pulse input/output module							
				First module		Second module		Third module		Fourth module	
CH1	CH2	CH3	CH4	CH5	CH6	CH7	CH8	CH9	CH10	CH11	CH12
SM5332	SM5333	SM5334	SM5335	SM5336	SM5337	SM5338	SM5339	SM5340	SM5341	SM5342	SM5343

### ■Update timing

The timing of device update is as follows.

ON	OFF
<ul style="list-style-type: none"> <li>At stop of pulse output due to an error in the setting value of the pulse width, period, or output pulse count</li> <li>At stop of pulse output due to the relation of pulse width &gt; period</li> <li>In the case of forced stop with SM8034 (all output disable) or output cannot be started</li> </ul>	<ul style="list-style-type: none"> <li>Power OFF→ON, reset, STOP/PAUSE→RUN</li> <li>When pulse output starts</li> <li>When turned OFF by the user</li> <li>After forced stop by SM8034 (all output disable), SM8034 is turned off, and PWM output resumes (only when unlimited output)</li> </ul>

#### Point

The ON timing of the PWM output abnormal end flag includes startup of the PWM/DPWM, HIOEN/ DHIEN instruction.

## Number of output pulses

The number of output pulses of PWM output is stored.

When "0" is set, output is continued without any limitation.

### ■Corresponding devices

The device numbers corresponding to each channel are as follows.

CPU module				High-speed pulse input/output module							
				First module		Second module		Third module		Fourth module	
CH1	CH2	CH3	CH4	CH5	CH6	CH7	CH8	CH9	CH10	CH11	CH12
SD5301, SD5300	SD5317, SD5316	SD5333, SD5332	SD5349, SD5348	SD5365, SD5364	SD5381, SD5380	SD5397, SD5396	SD5413, SD5412	SD5429, SD5428	SD5445, SD5444	SD5461, SD5460	SD5477, SD5476

### ■Update timing

The timing to reflect the device in operation is as follows.

- When the HCMOV/DHCMOV instruction is executed (values updated immediately)
- When the PWM/DPWM instruction is executed
- END processing

### ■Clear timing

The timing when the device is cleared is as follows.

- STOP/PAUSE→RUN

#### Point

- If the number of output pulses written is equal to or smaller than the number of pulses that have already been output, pulse output is stopped after the pulses being currently output are completed.
- If the number of output pulses written is greater than the number of pulses that have already been output, pulse output is stopped after the specified number of pulses are output.
- If the number of output pulses is set to "0" (output without any limitation), the value cannot be changed while pulses are being output.
- The number of output pulses cannot be changed to "0" (output without any limitation) while pulses are being output.



## Pulse width

The pulse width of PWM output is stored.

### ■Corresponding devices

The device numbers corresponding to each channel are as follows.

CPU module				High-speed pulse input/output module							
				First module		Second module		Third module		Fourth module	
CH1	CH2	CH3	CH4	CH5	CH6	CH7	CH8	CH9	CH10	CH11	CH12
SD5303, SD5302	SD5319, SD5318	SD5335, SD5334	SD5351, SD5350	SD5367, SD5366	SD5383, SD5382	SD5399, SD5398	SD5415, SD5414	SD5431, SD5430	SD5447, SD5446	SD5463, SD5462	SD5479, SD5478

### ■Update timing

The timing to reflect the device in operation is as follows.

- When the HCMOV/DHCMOV instruction is executed (values updated immediately)
- When the PWM/DPWM instruction is executed
- END processing

### ■Clear timing

The timing when the device is cleared is as follows.

- STOP/PAUSE→RUN

#### Point

- The pulse width and cycle can be changed even while pulses are being output.
- The pulse width and cycle are stored in the unit specified by the parameter (ms or  $\mu$ s).

## Period

The period of PWM output is stored.

### ■Corresponding devices

The device numbers corresponding to each channel are as follows.

CPU module				High-speed pulse input/output module							
				First module		Second module		Third module		Fourth module	
CH1	CH2	CH3	CH4	CH5	CH6	CH7	CH8	CH9	CH10	CH11	CH12
SD5305, SD5304	SD5321, SD5320	SD5337, SD5336	SD5353, SD5352	SD5369, SD5368	SD5385, SD5384	SD5401, SD5400	SD5417, SD5416	SD5433, SD5432	SD5449, SD5448	SD5465, SD5464	SD5481, SD5480

### ■Update timing

The timing to reflect the device in operation is as follows.

- When the HCMOV/DHCMOV instruction is executed (values updated immediately)
- When the PWM/DPWM instruction is executed
- END processing

### ■Clear timing

The timing when the device is cleared is as follows.

- STOP/PAUSE→RUN

#### Point

- The pulse width and cycle can be changed even while pulses are being output.
- The pulse width and cycle are stored in the unit specified by the parameter (ms or  $\mu$ s).

## Number of output pulses current value monitor

The current value of the number of output pulses of PWM output is stored.

### ■Corresponding devices

The device numbers corresponding to each channel are as follows.

CH1	CH2	CH3	CH4
SD5307, SD5306	SD5323, SD5322	SD5339, SD5338	SD5355, SD5354

### ■Update timing

The timing to reflect the device in operation is as follows.

- When the HCMOV/DHCMOV instruction is executed (values updated immediately)
- When the PWM/DPWM instruction is executed
- END processing

### ■Clear timing

The timing when the device is cleared is as follows.

- Power OFF→ON
- Reset
- STOP/PAUSE→RUN

#### Point

- If the number of output pulses is set to "0" (output without any limitation), the number of output pulse current value monitor is fixed at "0".
- The number of output pulse current value monitor can be changed even while pulses are being output.

## Cautions when using the PWM function

- Set the pulse width and period for each module as follows.

Module	Pulse width	Period
FX5S CPU module	5 $\mu$ s or more	10 $\mu$ s or more
FX5UJ CPU module	2 $\mu$ s or more	5 $\mu$ s or more
FX5U/FX5UC CPU module		
High-speed pulse input/output module		

- Set the value so that pulse width  $\leq$  period.
- The PWM/DPWM instruction is not executed when a channel number not selected for PWM output in parameters setting is specified by the PWM/DPWM instruction.
- If the all output disable flag (SM8034) is turned ON while PWM is output, PWM output is stopped. However, when the number of output pulses is "0" (unlimited output), the operation restarts when SM8034 is turned OFF.
- In a program with interruption priority 1, the HCMOV/DHCMOV instruction specified with the following devices cannot be executed.
  - Number of output pulses
  - Pulse width
  - Period
- For functions that share outputs with the PWM function, refer to  Page 285 Functions that share inputs and outputs.

# Examples of program

An example of a program using the PWM function is explained below.

## Outline of operation

An example of a program using output Y0 on the FX5U CPU module to output one pulse with a delay is explained below.

## Parameter setting

This program assumes that parameters are set as follows.

CH2, CH3 and CH4 need not be set.

Item	CH to be used
	CH1
Output destination	Y0
Output pulse logic	Negative logic (Output from OFF)
Pulse width	50 ms
Cycle	60 ms

## Program

An operation diagram and program are shown below.

### ■ Operation diagram

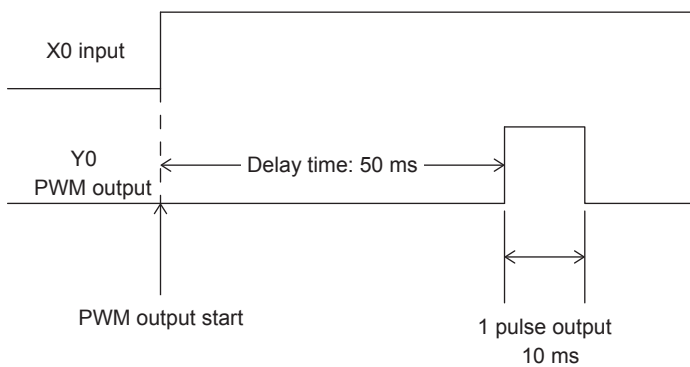

## Program

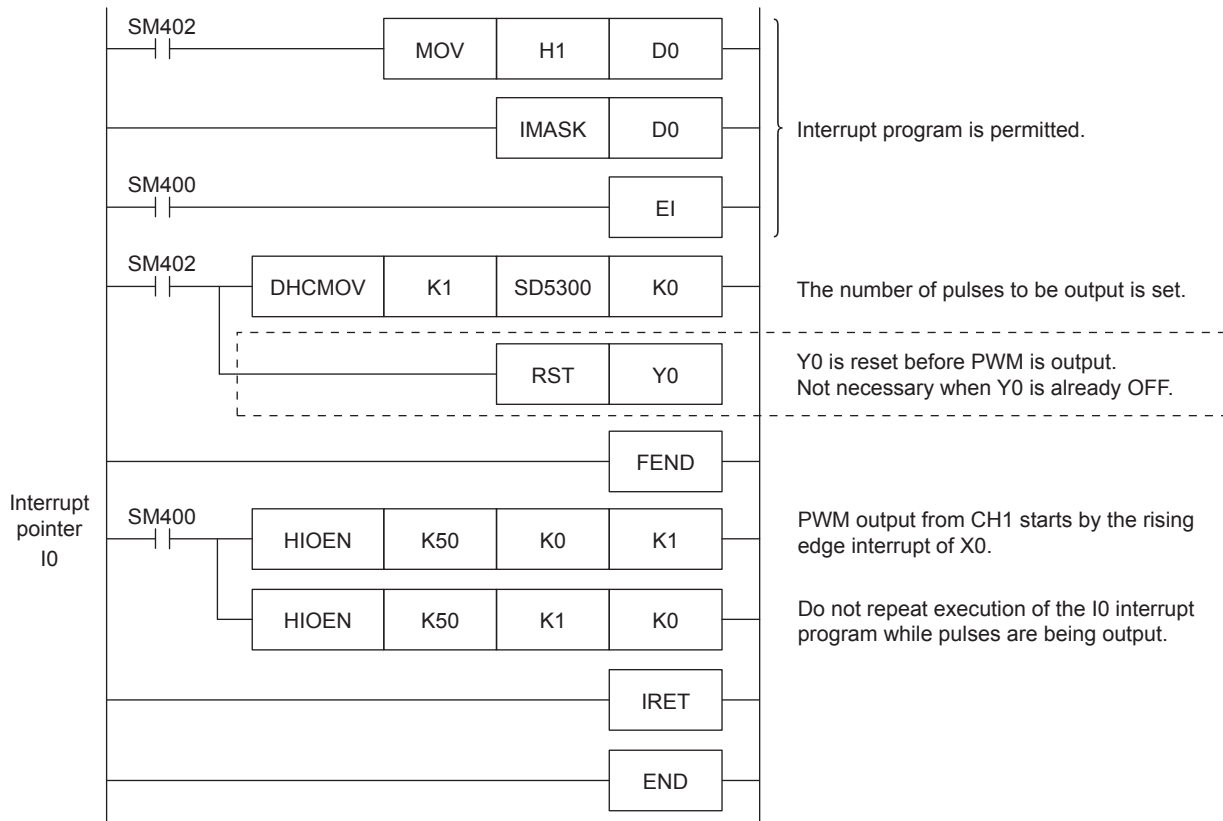

## Precautions

- PWM in the same channel as an ongoing PWM execution cannot be executed by the alternate of the PWM/DPWM instruction and HIOEN/DHIOEN instruction. However, the PWM operation that is already in execution continues.
- If a channel with invalid PWM output parameters is executed by HIOEN/DHIOEN instruction, the PWM output is not executed.
- In a program with interruption priority 1, the HIOEN/DHIOEN or PWM/DPWM instruction to start or stop PWM output of the high-speed pulse input/output module (CH5 to CH12) cannot be executed. (☞ Page 109 Interrupt priority)

This part consists of the following chapters.

27 OUTLINE

---

28 FUNCTION LIST

---

29 SPECIFICATIONS

---

30 POSITIONING CONTROL FUNCTION

---

31 POSITIONING PARAMETER

---

32 POSITIONING INSTRUCTION

---

33 TABLE OPERATION

---

34 PROGRAMMING

---

35 TROUBLESHOOTING

---

# 27 OUTLINE

The CPU module (transistor output) and high-speed pulse input/output module can perform positioning control by outputting pulse signals to servo motors or stepping motors. Increase the pulse frequency to increase the motor speed. Increase the number of pulses to increase the number of motor revolutions. In other words, set the pulse frequency to determine the workpiece transfer (positioning) speed. Set the number of pulses to determine the workpiece transfer distance.

## 27.1 Features

- Positioning functions include positioning using the CPU module built-in I/O and positioning using the high-speed pulse input/output module. For applicable version of high-speed pulse input/output module, refer to  Page 966 Added and Enhanced Functions.
- The positioning function can control up to 12 axes for positioning operations. (CPU module: 4 axes, High-speed pulse input/output module: 2 axes × 4 modules)
- Use positioning instructions and positioning parameters for positioning control.
- The pulse output method can be PULSE/SIGN mode or CW/CCW mode. General-purpose outputs can output a pulse train of 200 kpps (100 kpps for the FX5S CPU module).
- The positioning function is compatible with MELSERVO MR-J4□A, MR-J3□A and MR-JN□A series servo amplifiers.

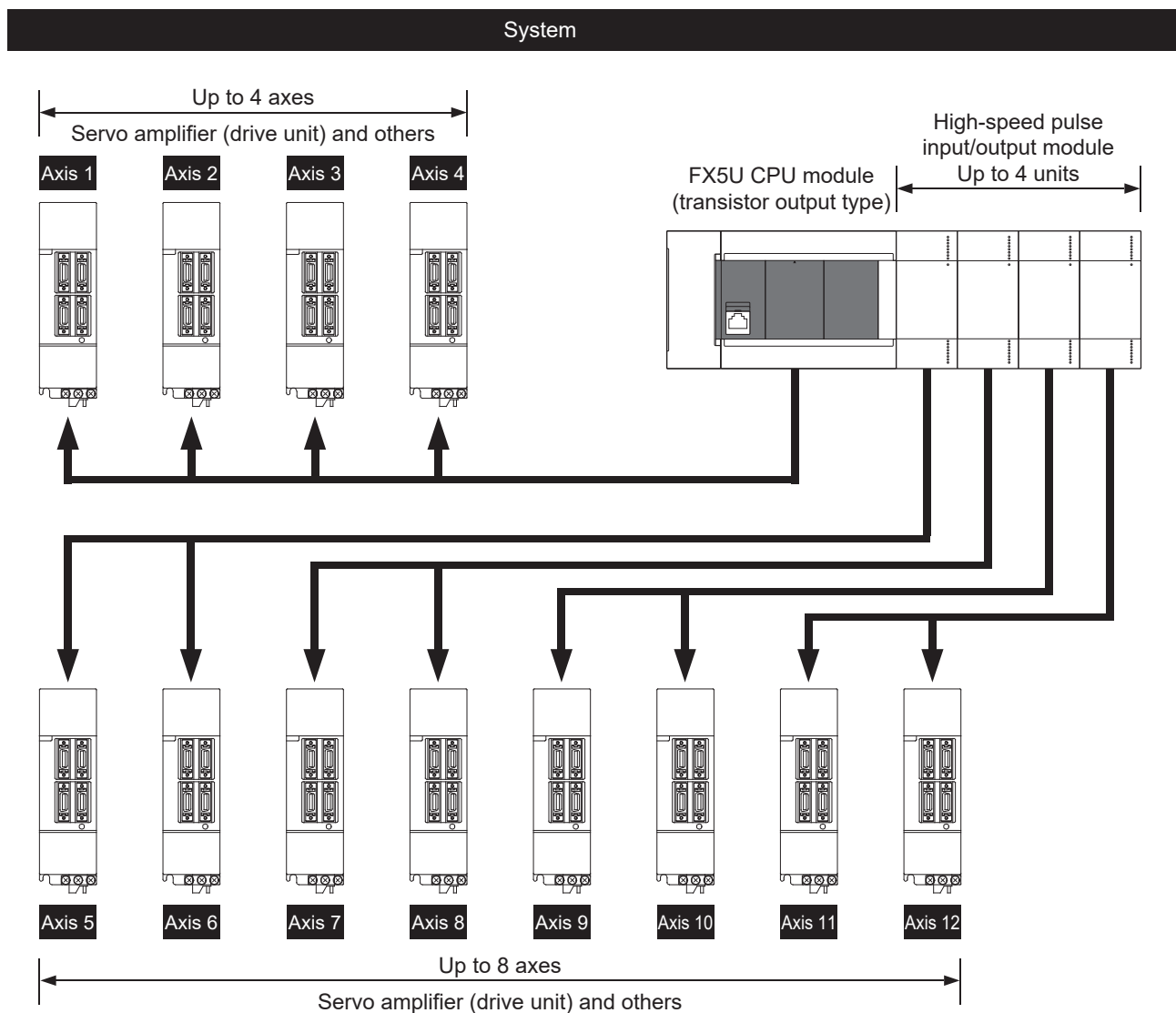

## 27.2 Setup Procedure for Positioning Control

### 1. Check specifications of incorporated positioning functions

For performance specifications, input specifications and output specifications, refer to  Page 336 SPECIFICATIONS.

For control function and auxiliary function, refer to  Page 348 POSITIONING CONTROL FUNCTION.

For connection equipment specifications, refer to the manual for each connection equipment.

### 2. System configuration and unit selection

Refer to the following manual and the manual for each connection equipment.

 MELSEC iQ-F FX5S/FX5UJ/FX5U/FX5UC User's Manual (Hardware)

### 3. Wiring

Refer to the following manual and the manual for each connection equipment.

 MELSEC iQ-F FX5S/FX5UJ/FX5U/FX5UC User's Manual (Hardware)

### 4. Parameter settings in GX Works3<sup>\*1</sup>

For setting method and details of parameters, refer to  Page 364 POSITIONING PARAMETER.

For table setting method and operations of control method, refer to  Page 487 TABLE OPERATION.

### 5. Creating programs in GX Works3<sup>\*1</sup>

For details of each positioning instruction, refer to  Page 402 POSITIONING INSTRUCTION.

For common items of each positioning instruction and cautions for program creation, refer to  Page 524 PROGRAMMING.

<sup>\*1</sup> For details on connecting procedures to a CPU module and operating procedures of GX Works3, refer to  GX Works3 Operating Manual.

# 28 FUNCTION LIST

When the positioning instructions and the positioning parameters are used together, various positioning operations are enabled.

☞ Page 402 POSITIONING INSTRUCTION

☞ Page 364 POSITIONING PARAMETER

The positioning functions of the FX5 PLC are shown below.

Positioning operation pattern	Reference	Positioning operation pattern	Reference																												
<p>JOG operation (substituted by variable speed operation)</p>	Page 354	<p>Interrupt 1-speed positioning</p>	Page 352																												
<p>Mechanical OPR</p>	Page 349	<p>Interrupt 2-speed positioning</p>	Page 353																												
<p>High-speed OPR</p>	Page 349	<p>Variable speed operation</p>	Page 354																												
<p>1-speed positioning</p>	Page 350	<p>Simple linear interpolation operation (2-axis simultaneous start)*1</p>	Page 355																												
<p>2-speed positioning</p>	Page 350	<p>Table operation</p> <table border="1"> <thead> <tr> <th>No.</th> <th>Device</th> <th>Control Method</th> <th>M.No. for Jump Condition</th> </tr> </thead> <tbody> <tr> <td>1</td> <td>D100</td> <td>4: Variable Speed Operation</td> <td>0</td> </tr> <tr> <td>2</td> <td>D106</td> <td>1: 1 Speed Positioning (Relative Address Specification)</td> <td>0</td> </tr> <tr> <td>3</td> <td>D112</td> <td>1: 1 Speed Positioning (Relative Address Specification)</td> <td>0</td> </tr> <tr> <td>4</td> <td>D118</td> <td>1: 1 Speed Positioning (Relative Address Specification)</td> <td>0</td> </tr> <tr> <td>5</td> <td>D124</td> <td>0: No Positioning</td> <td>0</td> </tr> <tr> <td>⋮</td> <td>⋮</td> <td>⋮</td> <td>⋮</td> </tr> </tbody> </table>	No.	Device	Control Method	M.No. for Jump Condition	1	D100	4: Variable Speed Operation	0	2	D106	1: 1 Speed Positioning (Relative Address Specification)	0	3	D112	1: 1 Speed Positioning (Relative Address Specification)	0	4	D118	1: 1 Speed Positioning (Relative Address Specification)	0	5	D124	0: No Positioning	0	⋮	⋮	⋮	⋮	Page 354
No.	Device	Control Method	M.No. for Jump Condition																												
1	D100	4: Variable Speed Operation	0																												
2	D106	1: 1 Speed Positioning (Relative Address Specification)	0																												
3	D112	1: 1 Speed Positioning (Relative Address Specification)	0																												
4	D118	1: 1 Speed Positioning (Relative Address Specification)	0																												
5	D124	0: No Positioning	0																												
⋮	⋮	⋮	⋮																												
<p>Multi-speed operation</p>	Page 351	<p>Absolute position detection system</p>	Page 483																												



Positioning operation pattern	Reference	Positioning operation pattern	Reference
Interrupt stop 	Page 351	—	—

\*1 Only FX5S/FX5U/FX5UC CPU module and high-speed pulse input/output module support this operation.

# 29 SPECIFICATIONS

For general specifications, power supply and system configuration, refer to the following manuals.

📖 MELSEC iQ-F FX5S/FX5UJ/FX5U/FX5UC User's Manual (Hardware)

## 29.1 Performance Specifications

The following list shows performance specifications of the positioning function.

For details on positioning parameter, refer to 📖 Page 364 POSITIONING PARAMETER.

Item	Description			
	FX5S CPU module	FX5UJ CPU module	FX5U/FX5UC CPU module	High-speed pulse input/output module*1
Number of control axes	4 axes*2 Pulse can be output from general-purpose outputs of the CPU module (axis 1: Y0, axis 2: Y1, axis 3: Y2, and axis 4: Y3).	3 axes Pulse can be output from general-purpose outputs of the CPU module (axis 1: Y0, axis 2: Y1, and axis 3: Y2).	4 axes*2 Pulse can be output from general-purpose outputs of the CPU module (axis 1: Y0, axis 2: Y1, axis 3: Y2, and axis 4: Y3).	2 axes /module, up to 4 modules can be connected Pulse can be output from general-purpose outputs of the high-speed pulse input/output module. <ul style="list-style-type: none"> <li>• First module axis 5: Y□, axis 6: Y□+1</li> <li>• Second module axis 7: Y□, axis 8: Y□+1</li> <li>• Third module axis 9: Y□, axis 10: Y□+1</li> <li>• Fourth module axis 11: Y□, axis 12: Y□+1</li> </ul> The number in □ is the head output number for each high-speed pulse input/output module.
Pulse output form	Transistor			
Maximum frequency	100 kpps (100 kpps in pulses)	200 kpps (200 kpps in pulses)		
Positioning program	Created in sequence program Table operation (can be set in GX Works3.) <ul style="list-style-type: none"> <li>• When the positioning table data set to use device: 100 data points/axis</li> <li>• When the positioning table data set to do not use device: 32 data points/axis</li> </ul>			Created in sequence program Table operation (can be set in GX Works3.) <ul style="list-style-type: none"> <li>• When the positioning table data set to use device: 100 data points/axis</li> </ul>
Position data	1 point (set in sequence program)			

Item		Description				
		FX5S CPU module	FX5UJ CPU module	FX5U/FX5UC CPU module	High-speed pulse input/output module*1	
Positioning	Pulse output mode		PULSE/SIGN mode CW/CCW mode	PULSE/SIGN mode	PULSE/SIGN mode CW/CCW mode	
	Positioning range	Control unit	Motor system, machine system, multiple system,			
		Number of pulses per rotation	0 to 2147483647			
		Travel distance per rotation	1 to 2147483647			
		Positioning data magnification	1, 10, 100, 1000 (times)			
		Positioning range	-2147483648 to +2147483647 (motor/machine/multiple unit system)*3			
	Speed command*4	Speed command unit	Determined by the set unit system			
		Bias speed	0 to 100 kpps (motor/multiple unit system) 0 to 2147483647 (machine unit system)	0 to 200 kpps (motor/multiple unit system) 0 to 2147483647 (machine unit system)		
		Maximum speed	1 pps to 100 kpps (motor/multiple unit system) 1 to 2147483647 (machine/multiple unit system)	1 pps to 200 kpps (motor/multiple unit system) 1 to 2147483647 (machine/multiple unit system)		
		OPR speed	1 pps to 100 kpps (motor/multiple unit system) 1 to 2147483647 (machine unit system)	1 pps to 200 kpps (motor/multiple unit system) 1 to 2147483647 (machine unit system)		
	Positioning	Speed command*4	Creep speed	1 pps to 100 kpps (motor/multiple unit system) 1 to 2147483647 (machine unit system)	1 pps to 200 kpps (motor/multiple unit system) 1 to 2147483647 (machine unit system)	
			Acceleration time	0 to 32767 ms		
			Deceleration time	0 to 32767 ms		
Acceleration/deceleration process		Trapezoidal acceleration/deceleration				
Absolute position detection (ABS current value reading)		DABS instruction used				
Interpolation		Simple linear interpolation operation by 2-axis simultaneous start	—	Simple linear interpolation operation by 2-axis simultaneous start		
Start time (time until pulse output is started after execution of the instruction is started)		When using the external start signal: 50 μs or less Interpolation operation: 300 μs or less	When using the external start signal: 50 μs or less	When using the external start signal: 50 μs or less Interpolation operation: 300 μs or less	When using the external start signal: 300 μs or less Interpolation operation: 400 μs or less	

\*1 Only FX5UJ/FX5U/FX5UC CPU module can be connected.

\*2 The number of control axes is two when the pulse output mode is CW/CCW mode.

\*3 Set the number of output pulses per operation to 2147483647 or lower.

\*4 For the start speed, refer to  Page 402 Start speed.

## 29.2 Input Specifications

The input specifications of the CPU module and high-speed pulse input/output module are explained below.

Note that the simultaneous turning-on rate of the CPU module is restricted. For details on this restriction, refer to the following manuals.

📖 MELSEC iQ-F FX5S/FX5UJ/FX5U/FX5UC User's Manual (Hardware)

### FX5S CPU module

Item		Specifications
Input signal voltage		24 V DC +20%, -15%
Input impedance	X0 to X7	4.3 kΩ
	X10 and subsequent	5.6 kΩ
Input signal current	X0 to X7	5.1 mA/24 V DC
	X10 and subsequent	4.0 mA/24 V DC
ON input sensitivity current	X0 to X7	3.5 mA or more
	X10 and subsequent	3.0 mA or more
OFF input sensitivity current		1.5 mA or less
Input response time (H/W filter delay)	X0, X1, X3, X4	ON: 5.0 μs or less OFF: 5.0 μs or less
	X2, X5 to X7	ON: 30 μs or less OFF: 50 μs or less
	X10 to X17	ON: 50 μs or less OFF: 150 μs or less
	X20 or subsequent	ON: Approx. 10 ms OFF: Approx. 10 ms
Input response time (Digital filter setting value) <sup>*1</sup>		None, 10 μs, 50 μs, 0.1 ms, 0.2 ms, 0.4 ms, 0.6 ms, 1 ms, 5 ms, 10 ms (initial values), 20 ms, 70 ms
Input signal type	Sink input	No-voltage contact input NPN open collector transistor
	Source input	No-voltage contact input PNP open collector transistor
Indication of input motion		Turning on the input will light the LED indicator lamp

\*1 This can be set only for X0 to X17.

## FX5UJ CPU module

Item		Specifications
Input signal voltage		24 V DC +20%, -15%
Input impedance	X0 to X7	4.3 k $\Omega$
	X10 and subsequent	5.6 k $\Omega$
Input signal current	X0 to X7	5.3 mA/24 V DC
	X10 and subsequent	4.0 mA/24 V DC
ON input sensitivity current	X0 to X7	3.5 mA or more
	X10 and subsequent	3.0 mA or more
OFF input sensitivity current		1.5 mA or less
Input response time (H/W filter delay)	X0, X1, X3, X4	ON: 5.0 $\mu$ s or less OFF: 5.0 $\mu$ s or less
	X2, X5 to X7	ON: 30 $\mu$ s or less OFF: 50 $\mu$ s or less
	X10 to X17	ON: 50 $\mu$ s or less OFF: 150 $\mu$ s or less
	X20 or subsequent	ON: Approx. 10 ms OFF: Approx. 10 ms
Input response time (Digital filter setting value)		None, 10 $\mu$ s, 50 $\mu$ s, 0.1 ms, 0.2 ms, 0.4 ms, 0.6 ms, 1 ms, 5 ms, 10 ms (initial values), 20 ms, 70 ms
Input signal type		No-voltage contact input Sink input: NPN open collector transistor Source input: PNP open collector transistor
Indication of input motion		Turning on the input will light the LED indicator lamp

## FX5U CPU module

Item		Specifications	
Input signal voltage		24 V DC +20%, -15%	
Input impedance	X0 to X17	4.3 k $\Omega$	
	X20 or subsequent	5.6 k $\Omega$	
Input signal current	X0 to X17	5.3 mA/24 V DC	
	X20 or subsequent	4.0 mA/24 V DC	
ON input sensitivity current	X0 to X17	3.5 mA or more	
	X20 or subsequent	3.0 mA or more	
OFF input sensitivity current		1.5 mA or less	
Input response time (H/W filter delay)	FX5U-32MT/ $\square$	X0 to X5	ON: 2.5 $\mu$ s or less OFF: 2.5 $\mu$ s or less
	FX5U-64MT/ $\square$ , FX5U-80MT/ $\square$	X0 to X7	
	FX5U-32MT/ $\square$	X6 to X17	ON: 30 $\mu$ s or less OFF: 50 $\mu$ s or less
	FX5U-64MT/ $\square$ , FX5U-80MT/ $\square$	X10 to X17	
		X20 or subsequent	ON: 50 $\mu$ s or less OFF: 150 $\mu$ s or less
Input response time (Digital filter setting value)		None, 10 $\mu$ s, 50 $\mu$ s, 0.1 ms, 0.2 ms, 0.4 ms, 0.6 ms, 1 ms, 5 ms, 10 ms (initial values), 20 ms, 70 ms	
Input signal type		No-voltage contact input Sink input: NPN open collector transistor Source input: PNP open collector transistor	
Indication of input motion		Turning on the input will light the LED indicator lamp	

## FX5UC CPU module

Item		Specifications	
Input signal voltage		24 V DC +20%, -15%	
Input impedance	X0 to X17	4.3 kΩ	
	X20 or subsequent	5.6 kΩ	
Input signal current	X0 to X17	5.3 mA/24 V DC	
	X20 or subsequent	4.0 mA/24 V DC	
ON input sensitivity current	X0 to X17	3.5 mA or more	
	X20 or subsequent	3.0 mA or more	
OFF input sensitivity current		1.5 mA or less	
Input response time (H/W filter delay)	FX5UC-32MT/□	X0 to X5	ON: 2.5 μs or less OFF: 2.5 μs or less
	FX5UC-64MT/□, FX5UC-96MT/□	X0 to X7	
	FX5UC-32MT/□	X6 to X17	ON: 30 μs or less OFF: 50 μs or less
	FX5UC-64MT/□, FX5UC-96MT/□	X10 to X17	
	FX5UC-64MT/□, FX5UC-96MT/□	X20 or subsequent	ON: 50 μs or less OFF: 150 μs or less
Input response time (Digital filter setting value)		None, 10 μs, 50 μs, 0.1 ms, 0.2 ms, 0.4 ms, 0.6 ms, 1 ms, 5 ms, 10 ms (initial values), 20 ms, 70 ms	
Input signal type	FX5UC-□MT/D	No-voltage contact input NPN open collector transistor	
	FX5UC-□MT/DSS	No-voltage contact input Sink input: NPN open collector transistor Source input: PNP open collector transistor	
Indication of input motion	FX5UC-□MT/D(SS)	Turning on the input will light the LED indicator lamp (DISP switch IN side)	
	FX5UC-32MT/DS(S)-TS	Turning on the input will light the LED indicator lamp	

## High-speed pulse input/output module

Item		Specifications
Input signal voltage		24 V DC +20%, -15%
Input impedance		4.3 kΩ
Input signal current		5.3 mA/24 V DC
ON input sensitivity current		3.5 mA or more
OFF input sensitivity current		1.5 mA or less
Input response time (H/W filter delay)	X□ to X□+5*1	ON: 2.5 μs or less OFF: 2.5 μs or less
	X□+6, X□+7*1	ON: 30 μs or less OFF: 50 μs or less
Input response time (Digital filter setting value)		None, 10 μs, 50 μs, 0.1 ms, 0.2 ms, 0.4 ms, 0.6 ms, 1 ms, 5 ms, 10 ms (initial values), 20 ms, 70 ms
Input signal type		No-voltage contact input Sink input: NPN open collector transistor Source input: PNP open collector transistor
Indication of input motion		Turning on the input will light the LED indicator lamp

\*1 □: Head input number for high-speed pulse input/output module

# Input assignment

Input numbers of the CPU module and high-speed pulse input/output module are assigned as follows.

For parameter settings in GX Works3, refer to [Page 364 POSITIONING PARAMETER](#).

## CPU module

Application		Input number	Remarks								
Stop command		All input points	Connect a line to any input. If the line-connected input is turned on, the following operations stop the pulse output. <ul style="list-style-type: none"> <li>• Turn off the positioning instruction signal.</li> <li>• Turn on the pulse output stop command.</li> <li>• Turn on the pulse decelerate and stop command.</li> </ul>								
OPR	Start command	All input points	Connect a line to any input. When the line-connected input is turned on, drive the DSZR/DDSZR instruction. ( <a href="#">Page 411 Mechanical OPR</a> )								
	Near-point signal (DOG)	X0 to X17 <sup>*1</sup>	Connect a line to the input specified in the parameter setting of GX Works3. The signal does not occupy the input interrupt function, and its edge is detected with a 1-ms interrupt. For the near-point signal, refer to <a href="#">Page 390 Near-point Dog Signal</a> .								
	Zero signal	X0 to X17 <sup>*1</sup>	Connect a line to the input specified in the parameter setting of GX Works3. The input interrupt function is assigned forcibly to a specified input. For the zero signal, refer to <a href="#">Page 391 Zero Signal</a> .								
ABS read		All input points	Connect a line if it is necessary to use the absolute position detection system. Connect a line to the input specified by the DABS instruction. ( <a href="#">Page 483 Absolute Position Detection System</a> ) 3 consecutive input points are used for this function.								
External start signal		X0 to X17	Connect a line to the input specified in the parameter setting of GX Works3. The input interrupt function is assigned forcibly to a specified input.								
Interrupt input signal 1		X0 to X17	Connect a line to the input specified in the parameter setting of GX Works3. The input interrupt function is assigned forcibly to a specified input.								
Interrupt input signal 2		X0 to X17	Connect a line to the input specified in the table parameter setting of GX Works3. The signal does not occupy the input interrupt function, and its edge is detected with a 1-ms interrupt.								
Forward rotation limit (LSF)		All input points	Connect a line to any input. When the line-connected input is turned on, the forward limit relay must be turned on. The forward limit depends on the axis number as shown in the following table. <table border="1" style="margin-left: auto; margin-right: auto;"> <thead> <tr> <th>Axis 1</th> <th>Axis 2</th> <th>Axis 3</th> <th>Axis 4<sup>*2</sup></th> </tr> </thead> <tbody> <tr> <td>SM5660</td> <td>SM5661</td> <td>SM5662</td> <td>SM5663</td> </tr> </tbody> </table>	Axis 1	Axis 2	Axis 3	Axis 4 <sup>*2</sup>	SM5660	SM5661	SM5662	SM5663
Axis 1	Axis 2	Axis 3	Axis 4 <sup>*2</sup>								
SM5660	SM5661	SM5662	SM5663								
Reverse rotation limit (LSR)		All input points	Connect a line to any input. When the line-connected input is turned on, reverse limit relay must be turned on. The reverse limit depends on the axis number as shown in the following table. <table border="1" style="margin-left: auto; margin-right: auto;"> <thead> <tr> <th>Axis 1</th> <th>Axis 2</th> <th>Axis 3</th> <th>Axis 4<sup>*2</sup></th> </tr> </thead> <tbody> <tr> <td>SM5676</td> <td>SM5677</td> <td>SM5678</td> <td>SM5679</td> </tr> </tbody> </table>	Axis 1	Axis 2	Axis 3	Axis 4 <sup>*2</sup>	SM5676	SM5677	SM5678	SM5679
Axis 1	Axis 2	Axis 3	Axis 4 <sup>*2</sup>								
SM5676	SM5677	SM5678	SM5679								

\*1 In the case of FX3 compatible operand, DSZR/DDSZR instruction can use bit device other than X. In this case, the near-point signal (DOG) and zero signal must be assigned to the same device. For details, refer to [Page 411 Mechanical OPR](#).

\*2 Only FX5S/FX5U/FX5UC CPU module can use the devices of axis 4.

## High-speed pulse input/output module

Application		Axis <sup>*1</sup>	Input number	Remarks																
Stop command		All axes	All input points <sup>*2</sup>	Connect a line to any input. If the line-connected input is turned on, the following operations stop the pulse output. <ul style="list-style-type: none"> <li>• Turn off the positioning instruction signal.</li> <li>• Turn on the pulse output stop command.</li> <li>• Turn on the pulse decelerate and stop command.</li> </ul>																
OPR	Start command	All axes	All input points <sup>*2</sup>	Connect a line to any input. When the line-connected input is turned on, drive the DSZR/DDSZR instruction. (☞ Page 411 Mechanical OPR)																
	Near-point signal (DOG)	All axes	All input points <sup>*2</sup>	Connect a line to the input specified in the parameter setting of GX Works3. The signal does not occupy the input interrupt function, and its edge is detected with a 1-ms interrupt. For the near-point signal, refer to ☞ Page 390 Near-point Dog Signal.																
	Zero signal	5, 7, 9, 11 6, 8, 10, 12	X□+5 <sup>*3</sup> X□+2 <sup>*3</sup>	Connect a line to fixed assignment input in each module. For the zero signal, refer to ☞ Page 391 Zero Signal.																
ABS read		All axes	All input points <sup>*2</sup>	Connect a line if it is necessary to use the absolute position detection system. Connect a line to the input specified by the DABS instruction. (☞ Page 483 Absolute Position Detection System) 3 consecutive input points are used for this function.																
External start signal		5, 7, 9, 11 6, 8, 10, 12	X□+7 <sup>*3</sup> X□+6 <sup>*3</sup>	Connect a line to fixed assignment input in each module.																
Interrupt input signal 1		5, 7, 9, 11 6, 8, 10, 12	X□+4 <sup>*3</sup> X□+3 <sup>*3</sup>	Connect a line to fixed assignment input in each module.																
Forward rotation limit (LSF)		All axes	All input points <sup>*2</sup>	Connect a line to any input. When the line-connected input is turned on, the forward limit relay must be turned on. The forward limit depends on the axis number as shown in the following table. <table border="1" data-bbox="694 1048 1455 1126"> <thead> <tr> <th>Axis 5</th> <th>Axis 6</th> <th>Axis 7</th> <th>Axis 8</th> <th>Axis 9</th> <th>Axis 10</th> <th>Axis 11</th> <th>Axis 12</th> </tr> </thead> <tbody> <tr> <td>SM5664</td> <td>SM5665</td> <td>SM5666</td> <td>SM5667</td> <td>SM5668</td> <td>SM5669</td> <td>SM5670</td> <td>SM5671</td> </tr> </tbody> </table>	Axis 5	Axis 6	Axis 7	Axis 8	Axis 9	Axis 10	Axis 11	Axis 12	SM5664	SM5665	SM5666	SM5667	SM5668	SM5669	SM5670	SM5671
Axis 5	Axis 6	Axis 7	Axis 8	Axis 9	Axis 10	Axis 11	Axis 12													
SM5664	SM5665	SM5666	SM5667	SM5668	SM5669	SM5670	SM5671													
Reverse rotation limit (LSR)		All axes	All input points <sup>*2</sup>	Connect a line to any input. When the line-connected input is turned on, reverse limit relay must be turned on. The reverse limit depends on the axis number as shown in the following table. <table border="1" data-bbox="694 1234 1455 1312"> <thead> <tr> <th>Axis 5</th> <th>Axis 6</th> <th>Axis 7</th> <th>Axis 8</th> <th>Axis 9</th> <th>Axis 10</th> <th>Axis 11</th> <th>Axis 12</th> </tr> </thead> <tbody> <tr> <td>SM5680</td> <td>SM5681</td> <td>SM5682</td> <td>SM5683</td> <td>SM5684</td> <td>SM5685</td> <td>SM5686</td> <td>SM5687</td> </tr> </tbody> </table>	Axis 5	Axis 6	Axis 7	Axis 8	Axis 9	Axis 10	Axis 11	Axis 12	SM5680	SM5681	SM5682	SM5683	SM5684	SM5685	SM5686	SM5687
Axis 5	Axis 6	Axis 7	Axis 8	Axis 9	Axis 10	Axis 11	Axis 12													
SM5680	SM5681	SM5682	SM5683	SM5684	SM5685	SM5686	SM5687													

\*1 The axes of high-speed pulse input/output module are assigned as described below. The high-speed pulse input/output modules are ordered as the first module, second module, next modules from nearest to the CPU module.

First module		Second module		Third module		Fourth module	
Axis 5	Axis 6	Axis 7	Axis 8	Axis 9	Axis 10	Axis 11	Axis 12

\*2 CPU module inputs can also be used.

\*3 □: Head input number for high-speed pulse input/output module

The inputs that have not been assigned to a function by GX Works3 parameter can be used as general-purpose inputs.



## 29.3 Output Specifications

This section describes the transistor output specifications of the CPU module and high-speed pulse input/output module. Note that the simultaneous turning-on rate of the CPU module is restricted. For details on this restriction, refer to the following manuals.

■ MELSEC iQ-F FX5S/FX5UJ/FX5U/FX5UC User's Manual (Hardware)

### CPU module

For MELSERVO series servo amplifiers, use a sink input/sink output type CPU module.

Item		Specifications	
External power supply		5 to 30 V DC	
Maximum load	FX5S-□MT/□	0.5 A/point The total load current per common terminal should be the following value or less. • 3 output point common: 0.6 A • 4 output point common: 0.8 A	
	FX5UJ-□MT/□	0.5 A/point The total load current per common terminal should be the following value or less. • 3 output point common: 0.6 A • 4 output point common: 0.8 A	
	FX5U-□MT/□	0.5 A/point The total load current per common terminal should be the following value or less. • 4 output point common: 0.8 A • 8 output point common: 1.6 A	
	FX5UC-□MT/□	Y0 to Y3: 0.3 A/point Y4 or subsequent: 0.1 A/point The total load current per common terminal should be 0.8 A <sup>*1</sup> or less.	
Open-circuit leakage current		0.1 mA or less at 30 V DC	
Voltage drop when ON	FX5S-□MT/□	Y0 to Y3	1.0 V or less
	FX5UJ-□MT/□	Y0 to Y2	1.0 V or less
	FX5U-□MT/□, FX5UC-□MT/□	Y0 to Y3	
	FX5S-□MT/□	Y4 or subsequent	1.5 V or less
	FX5UJ-□MT/□	Y3 or subsequent	
	FX5U-□MT/□, FX5UC-□MT/□	Y4 or subsequent	
Response time	FX5S-□MT/□	Y0 to Y3	5 μs or less at 10 mA or more (5 to 24 V DC)
	FX5UJ-□MT/□	Y0 to Y2	2.5 μs or less at 10 mA or more (5 to 24 V DC)
	FX5U-□MT/□, FX5UC-□MT/□	Y0 to Y3	
	FX5S-□MT/□	Y4 or subsequent	0.2 ms or less at 200 mA (24 V DC)
	FX5UJ-□MT/□	Y3 or subsequent	
	FX5U-□MT/□	Y4 or subsequent	
	FX5UC-□MT/□		
Indication of output motion	FX5S-□MT/□, FX5UJ-□MT/□, FX5U-□MT/□, FX5UC-32MT/DS(S)-TS		LED on panel turns on when output
	FX5UC-□MT/D(SS)		LED on panel turns on when output (DISP switch OUT side)

\*1 When two COM■ (or +V■) terminals are connected outside the CPU module, the total load current is 1.6 A or less. Where ■ indicates: 0, 1 or 2

To use the positioning instruction, adjust the load current of the NPN open collector output to 10 to 100 mA (5 to 24 V DC).

Item	Description
Operation voltage range	5 to 24 V DC
Operation current range	10 to 100 mA
Output frequency	■ FX5S CPU module 100 kpps or less ■ FX5UJ/FX5U/FX5UC CPU module 200 kpps or less

## High-speed pulse input/output module

For MELSERVO series servo amplifiers, use a sink input/sink output type FX5-16ET/ES-H.

Item	Specifications	
External power supply	5 to 30 V DC	
Output type	FX5-16ET/ES-H	Transistor/sink output
	FX5-16ET/ESS-H	Transistor/source output
Maximum load	1.6 A/8 point common	
Open-circuit leakage current	0.1 mA or less at 30 V DC	
Voltage drop when ON	Y□, Y□+1, Y□+4, Y□+5 <sup>*1</sup>	1.0 V or less
	Y□+2, Y□+3, Y□+6, Y□+7 <sup>*1</sup>	1.5 V or less
Response time	Y□, Y□+1, Y□+4, Y□+5 <sup>*1</sup>	2.5 μs or less at 10 mA or more (5 to 24 V DC)
	Y□+2, Y□+3, Y□+6, Y□+7 <sup>*1</sup>	0.2 ms or less at 200 mA (24 V DC)
Indication of output motion	LED on panel turns on when output	

\*1 The number in □ is the head output number for each high-speed pulse input/output module.

To use the positioning instruction, adjust the load current of the NPN open collector output to 10 to 100 mA (5 to 24 V DC).

Item	Description
Operation voltage range	5 to 24 V DC
Operation current range	10 to 100 mA
Output frequency	200 kpps or less

## Sink internal output circuit

### ■FX5S/FX5UJ/FX5U CPU module

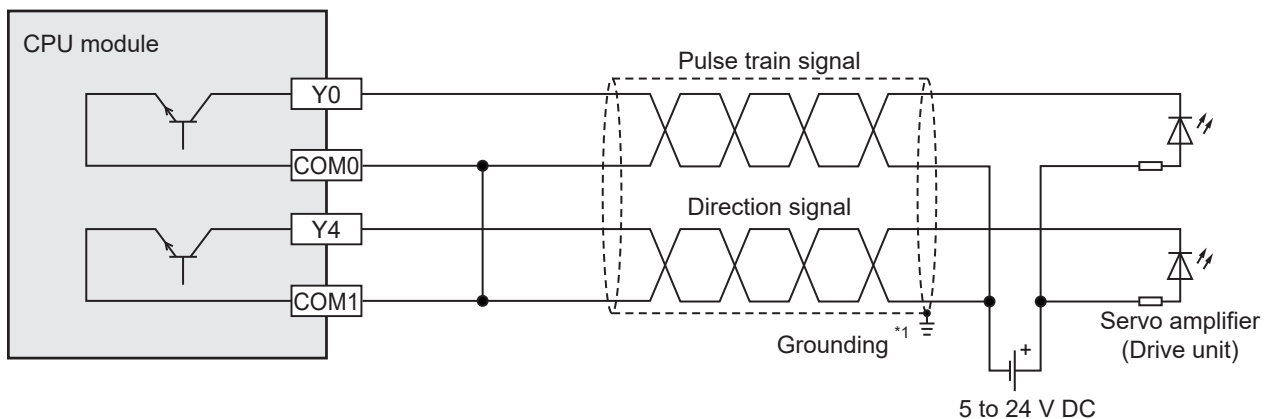

\*1 To ground the unit, refer to the servo amplifier (drive unit) manual.

If the grounding method is not specified, carry out class-D grounding (grounding resistance: 100 Ω or less).

### ■FX5UC CPU module

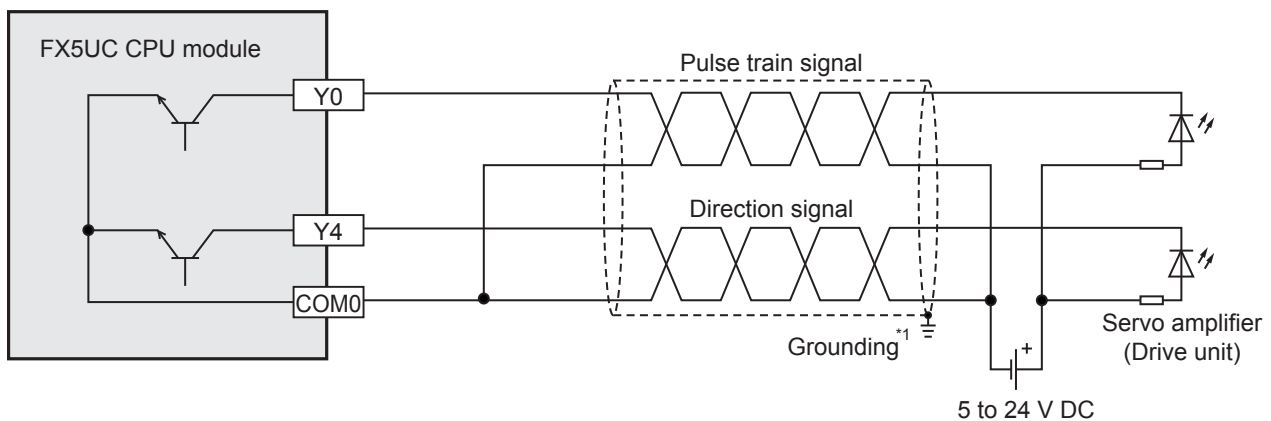

\*1 To ground the unit, refer to the servo amplifier (drive unit) manual.

If the grounding method is not specified, carry out class-D grounding (grounding resistance: 100 Ω or less).

## ■FX5-16ET/ES-H

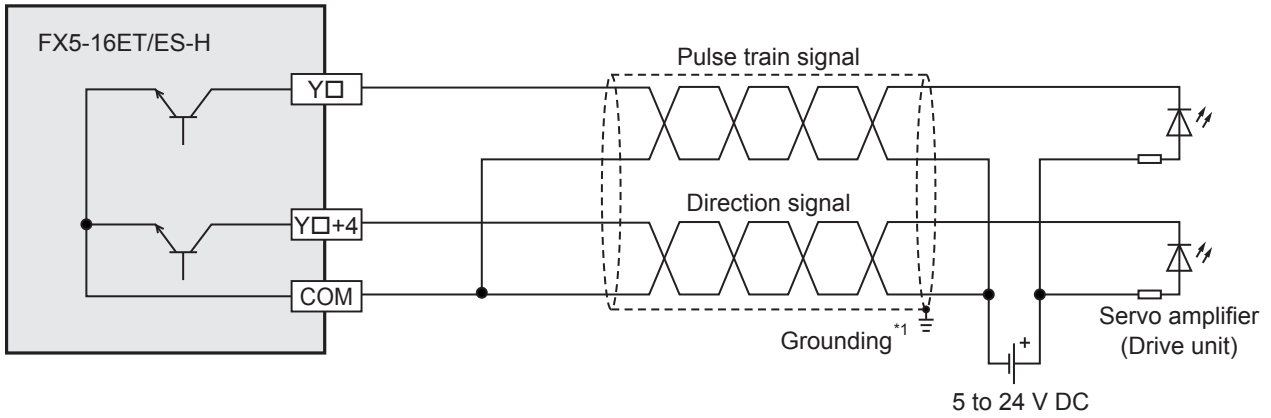

- \*1 To ground the unit, refer to the servo amplifier (drive unit) manual.  
If the grounding method is not specified, carry out class-D grounding (grounding resistance: 100 Ω or less).

## Source internal output circuit

### ■FX5S/FX5UJ/FX5U CPU module

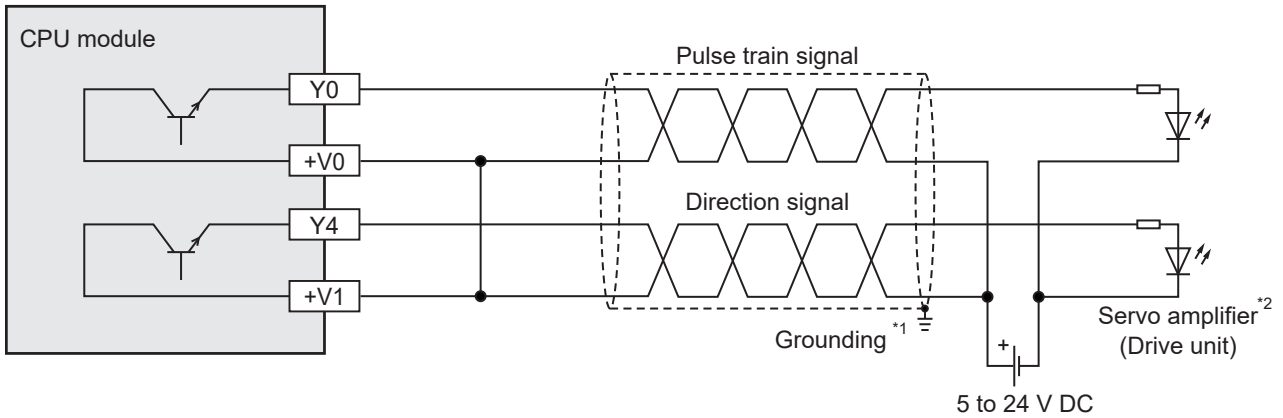

- \*1 To ground the unit, refer to the servo amplifier (drive unit) manual.  
If the grounding method is not specified, carry out class-D grounding (grounding resistance: 100 Ω or less).  
\*2 For MELSERVO series servo amplifiers, use a sink output type FX5U CPU module.

### ■FX5UC CPU module

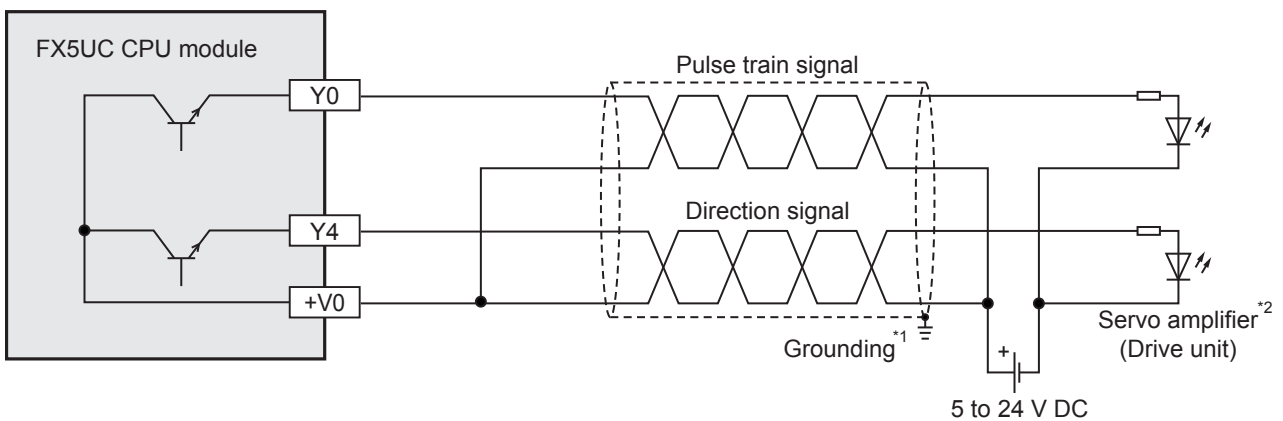

- \*1 To ground the unit, refer to the servo amplifier (drive unit) manual.  
If the grounding method is not specified, carry out class-D grounding (grounding resistance: 100 Ω or less).  
\*2 For MELSERVO series servo amplifiers, use a sink output type FX5UC CPU module.

## ■FX5-16ET/ESS-H

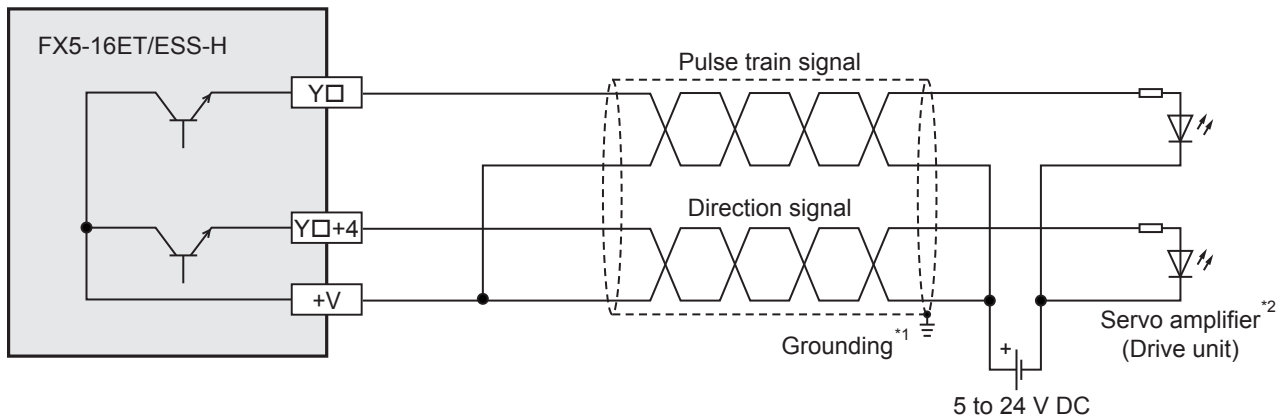

\*1 To ground the unit, refer to the servo amplifier (drive unit) manual.

If the grounding method is not specified, carry out class-D grounding (grounding resistance: 100 Ω or less).

\*2 For MELSERVO series servo amplifiers, use an FX5-16ET/ES-H (sink output type).

## Assignment of output numbers

Output numbers of the CPU module and high-speed pulse input/output module are assigned as follow.

For parameter settings in GX Works3, refer to [Page 364 POSITIONING PARAMETER](#).

### FX5UJ CPU module

Application	Output number	Remarks																																																																								
Pulse output destination	PULSE Y0 to Y2	The assignment is determined according to the output mode specified in GX Works3.																																																																								
Rotation direction signal	SIGN Y0 to Y17 <sup>*1</sup>	<table border="1"> <thead> <tr> <th>Axis number</th> <th>Output mode</th> <th>Y0</th> <th>Y1</th> <th>Y2</th> <th>Y3</th> <th>Y4</th> <th>Y5</th> <th>Y6</th> <th>Y7</th> <th>Y10</th> <th>Y11</th> <th>Y12</th> <th>Y13</th> <th>Y14</th> <th>Y15</th> <th>Y16</th> <th>Y17</th> </tr> </thead> <tbody> <tr> <td>Axis1</td> <td>PULSE/SIGN</td> <td>PLS</td> <td></td> <td></td> <td></td> <td></td> <td></td> <td></td> <td></td> <td colspan="8">SIGN</td> </tr> <tr> <td>Axis2</td> <td>PULSE/SIGN</td> <td>SIGN</td> <td>PLS</td> <td></td> <td></td> <td></td> <td></td> <td></td> <td></td> <td colspan="8">SIGN</td> </tr> <tr> <td>Axis3</td> <td>PULSE/SIGN</td> <td></td> <td>SIGN</td> <td>PLS</td> <td></td> <td></td> <td></td> <td></td> <td></td> <td colspan="8">SIGN</td> </tr> </tbody> </table> <p>PLS: Pulse train signal, SIGN: Direction signal</p>	Axis number	Output mode	Y0	Y1	Y2	Y3	Y4	Y5	Y6	Y7	Y10	Y11	Y12	Y13	Y14	Y15	Y16	Y17	Axis1	PULSE/SIGN	PLS								SIGN								Axis2	PULSE/SIGN	SIGN	PLS							SIGN								Axis3	PULSE/SIGN		SIGN	PLS						SIGN							
Axis number	Output mode	Y0	Y1	Y2	Y3	Y4	Y5	Y6	Y7	Y10	Y11	Y12	Y13	Y14	Y15	Y16	Y17																																																									
Axis1	PULSE/SIGN	PLS								SIGN																																																																
Axis2	PULSE/SIGN	SIGN	PLS							SIGN																																																																
Axis3	PULSE/SIGN		SIGN	PLS						SIGN																																																																
Clear signal	Y0 to Y17	When using the clear signal in the DSZR/DDSZR instruction, wire to the output specified in the high speed I/O parameter of GX Works3. ( <a href="#">Page 411 Mechanical OPR</a> , <a href="#">Page 389 Clear Signal Output</a> )																																																																								

\*1 Specify an output number for transistor output. Any output can be selected.

### FX5S/FX5U/FX5UC CPU module

Application	Output number	Remarks																																																																																																																																																																		
Pulse output destination	PULSE Y0 to Y3	The assignment is determined according to the output mode specified in GX Works3.																																																																																																																																																																		
	CW Y0, Y1																																																																																																																																																																			
Rotation direction signal	SIGN Y0 to Y17 <sup>*1</sup>	<table border="1"> <thead> <tr> <th>Axis number</th> <th>Output mode</th> <th>Y0</th> <th>Y1</th> <th>Y2</th> <th>Y3</th> <th>Y4</th> <th>Y5</th> <th>Y6</th> <th>Y7</th> <th>Y10</th> <th>Y11</th> <th>Y12</th> <th>Y13</th> <th>Y14</th> <th>Y15</th> <th>Y16</th> <th>Y17</th> </tr> </thead> <tbody> <tr> <td>Axis1</td> <td>PULSE/SIGN</td> <td>PLS</td> <td></td> <td></td> <td></td> <td></td> <td></td> <td></td> <td></td> <td colspan="8">SIGN</td> </tr> <tr> <td></td> <td>CW/CCW</td> <td>CW</td> <td>-</td> <td>CCW</td> <td></td> <td></td> <td></td> <td></td> <td></td> <td colspan="8">-</td> </tr> <tr> <td>Axis2</td> <td>PULSE/SIGN</td> <td>SIGN</td> <td>PLS</td> <td></td> <td></td> <td></td> <td></td> <td></td> <td></td> <td colspan="8">SIGN</td> </tr> <tr> <td></td> <td>CW/CCW</td> <td>-</td> <td>CW</td> <td>-</td> <td>CCW</td> <td></td> <td></td> <td></td> <td></td> <td colspan="8">-</td> </tr> <tr> <td>Axis3</td> <td>PULSE/SIGN</td> <td></td> <td>SIGN</td> <td>PLS</td> <td></td> <td></td> <td></td> <td></td> <td></td> <td colspan="8">SIGN</td> </tr> <tr> <td></td> <td>CW/CCW</td> <td></td> <td></td> <td></td> <td></td> <td></td> <td></td> <td></td> <td></td> <td colspan="8">-</td> </tr> <tr> <td>Axis4</td> <td>PULSE/SIGN</td> <td></td> <td></td> <td>SIGN</td> <td>PLS</td> <td></td> <td></td> <td></td> <td></td> <td colspan="8">SIGN</td> </tr> <tr> <td></td> <td>CW/CCW</td> <td></td> <td></td> <td></td> <td></td> <td></td> <td></td> <td></td> <td></td> <td colspan="8">-</td> </tr> </tbody> </table> <p>PLS: Pulse train signal, SIGN: Direction signal, CW: Forward pulse train, CCW: Reverse pulse train</p>	Axis number	Output mode	Y0	Y1	Y2	Y3	Y4	Y5	Y6	Y7	Y10	Y11	Y12	Y13	Y14	Y15	Y16	Y17	Axis1	PULSE/SIGN	PLS								SIGN									CW/CCW	CW	-	CCW						-								Axis2	PULSE/SIGN	SIGN	PLS							SIGN									CW/CCW	-	CW	-	CCW					-								Axis3	PULSE/SIGN		SIGN	PLS						SIGN									CW/CCW									-								Axis4	PULSE/SIGN			SIGN	PLS					SIGN									CW/CCW									-							
Axis number	Output mode	Y0	Y1	Y2	Y3	Y4	Y5	Y6	Y7	Y10	Y11	Y12	Y13	Y14	Y15	Y16	Y17																																																																																																																																																			
Axis1	PULSE/SIGN	PLS								SIGN																																																																																																																																																										
	CW/CCW	CW	-	CCW						-																																																																																																																																																										
Axis2	PULSE/SIGN	SIGN	PLS							SIGN																																																																																																																																																										
	CW/CCW	-	CW	-	CCW					-																																																																																																																																																										
Axis3	PULSE/SIGN		SIGN	PLS						SIGN																																																																																																																																																										
	CW/CCW									-																																																																																																																																																										
Axis4	PULSE/SIGN			SIGN	PLS					SIGN																																																																																																																																																										
	CW/CCW									-																																																																																																																																																										
Clear signal	Y0 to Y17	When using the clear signal in the DSZR/DDSZR instruction, wire to the output specified in the high speed I/O parameter of GX Works3. ( <a href="#">Page 411 Mechanical OPR</a> , <a href="#">Page 389 Clear Signal Output</a> )																																																																																																																																																																		

\*1 Specify an output number for transistor output. Any output can be selected.

## High-speed pulse input/output module

The assignment is determined according to the output mode specified in GX Works3.

Application		Output number*1							
		First module		Second module		Third module		Fourth module	
		Axis 5	Axis 6	Axis 7	Axis 8	Axis 9	Axis 10	Axis 11	Axis 12
Pulse output destination	PULSE/CW	Y□	Y□+1	Y□	Y□+1	Y□	Y□+1	Y□	Y□+1
Rotation direction signal	SIGN/CCW	Y□+4	Y□+5	Y□+4	Y□+5	Y□+4	Y□+5	Y□+4	Y□+5
Clear signal		Y□+2	Y□+3	Y□+2	Y□+3	Y□+2	Y□+3	Y□+2	Y□+3

\*1 The number in □ is the head output number for each high-speed pulse input/output module.

The high-speed pulse input/output modules are ordered as the first module, second module, next modules from nearest to the CPU module.

# 30 POSITIONING CONTROL FUNCTION

The positioning control outputs pulses with each positioning instruction and operates based on the positioning parameters (such as for speed and for operation flag). This chapter describes control patterns that are available for combinations of the positioning instructions and the positioning parameters.

For details on each positioning instruction, refer to [Page 402 POSITIONING INSTRUCTION](#).

For details on the control method of the table operation, refer to [Page 490 Operations of Control Method](#).

For details on each positioning parameter, refer to [Page 370 Details of Parameters](#).

## 30.1 List of Control Functions

The following list shows the positioning functions.

### List of control patterns

The following list shows the positioning function patterns.

Each control pattern is operated by corresponding positioning instruction.

○: Supported, —: Not supported

Operation pattern		Supported operation pattern			Reference
		CPU module		High-speed pulse input/output module	
		FX5S/FX5U/FX5UC	FX5UJ		
OPR control	Mechanical OPR	○	○	○	Page 349
	High-speed OPR	○	○	○	Page 349
Positioning control	1-speed positioning	○	○	○	Page 350
	2-speed positioning	○	○	○	Page 350
	Multi-speed operation	○	○	○	Page 351
	Interrupt stop	○	○	○	Page 351
	Interrupt 1-speed positioning	○	○	○	Page 352
	Interrupt 2-speed positioning	○	○	—	Page 353
	Variable speed operation	○	○	○	Page 354
	Table operation	○	○	○	Page 354
	Simple linear interpolation operation (2-axis simultaneous start)	○	—	○	Page 355

### List of auxiliary functions

The following list shows the auxiliary positioning functions that can be added to the control patterns above.

○: Supported, —: Not supported

Auxiliary function	Supported auxiliary functions			Reference
	CPU module		High-speed pulse input/output module	
	FX5S/FX5U/FX5UC	FX5UJ		
Dog search function	○	○	○	Page 356
Dwell time	○	○	○	Page 358
OPR zero signal counts	○	○	○	Page 358
Forward limit and reverse limit	○	○	○	Page 359
Positioning address change during positioning operation	○	○	○	Page 359
Command speed change during positioning operation	○	○	○	Page 360
Pulse decelerate and stop	○	○	○	Page 361
Remaining distance operation	○	○	○	Page 362
Multiple axes simultaneous activation	○	○	○	Page 363
Detection of absolute position	○	○	○	Page 363
All module reset when a stop error occurs	—	—	○	Page 363

# 30.2 OPR Control

This section describes details of the OPR control.

## Mechanical OPR

The DSZR/DDSZR instruction starts the OPR operation in the direction set by the OPR direction setting. (Page 387 OPR Direction) After the speed has reached the OPR speed, the operation will be performed at the specified OPR speed. Deceleration is started when the near-point dog signal is detected and the operation continues at creep speed. (Page 390 Near-point Dog Signal) The pulse output is stopped when the zero signal is detected for the specified number of times after the near-point dog signal is detected, and the mechanical OPR is completed. (Page 391 Zero Signal) When the OPR dwell time is set, the mechanical OPR is not completed until the dwell time has elapsed. (Page 358 Dwell time)

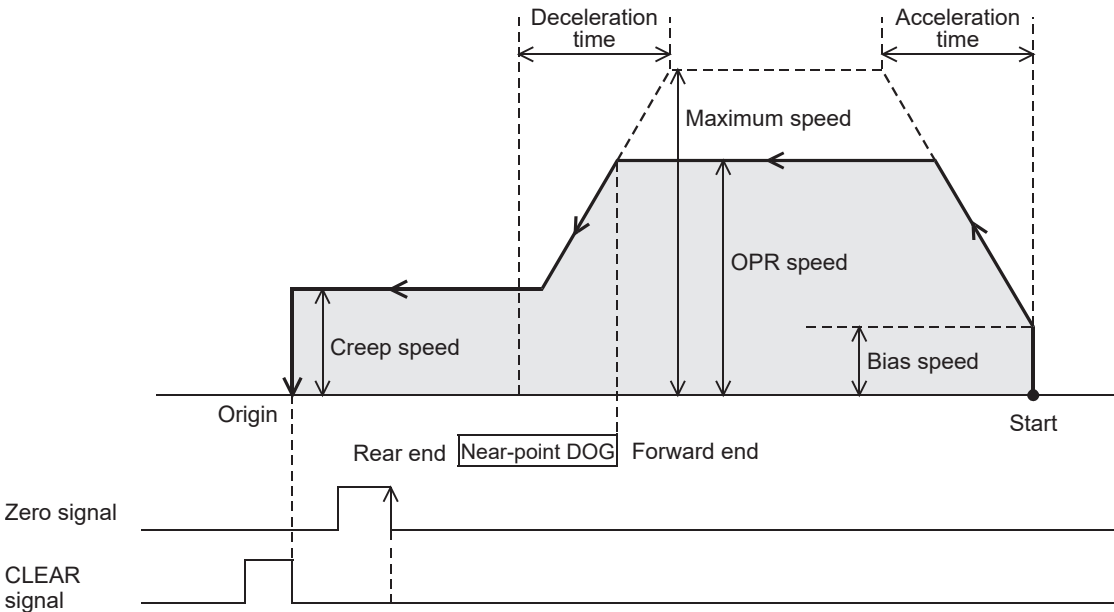

## High-speed OPR

The positioning is performed for the zero point address established by the mechanical OPR. The OPR can be performed at high-speed without using the near-point signal and the zero signal.

Set operands of instructions so that positioning address = zero position address\*1, command speed = OPR speed in the 1-speed positioning (absolute address). (Page 388 Starting Point Address)

\*1 Set the OPR address (can be specified in word device). With the table operation, the high-speed OPR can be performed only when the positioning table data is set to use device.

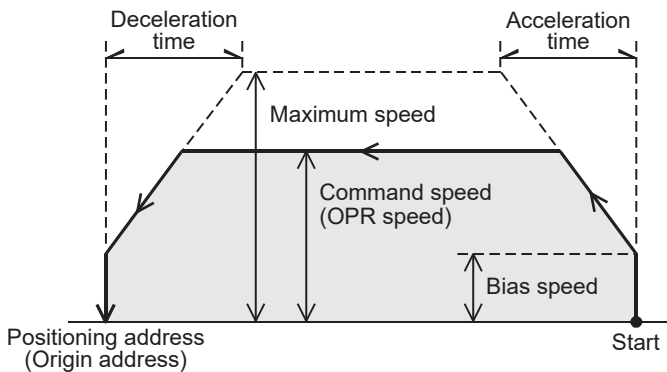

The following table shows applicable positioning instructions and control methods of the table operation.

Positioning instruction	Table operation control method
Absolute positioning (DRVA/DDRVA) instruction	2: 1 Speed Positioning (Absolute Address Specification)
Table operation (TBL*2/DRV TBL/DRVMUL) instruction	

\*2 Only CPU module is supported.

# 30.3 Positioning Control

This section describes details of the positioning control.

## 1-speed positioning

Acceleration is started at the bias speed when pulses are output by the positioning instruction. After the speed has reached the specified speed, the operation will be performed at the specified speed up to the point that deceleration must be performed. The operation decelerates in the vicinity of the target position and stops the pulse output at the position specified by the positioning address.

Both the relative address and the absolute address can be used for 1-speed positioning.

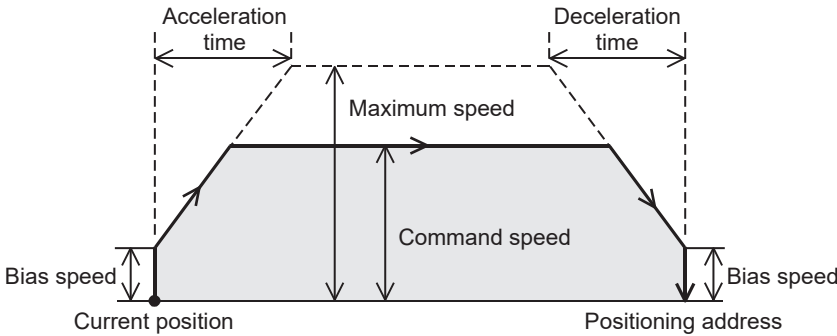

The following table shows applicable positioning instructions and control methods of the table operation.

Positioning instruction	Table operation control method
Relative positioning (DRV/DDRVI) instruction	<ul style="list-style-type: none"> <li>• 1: 1 Speed Positioning (Relative Address Specification)</li> <li>• 2: 1 Speed Positioning (Absolute Address Specification)</li> </ul>
Absolute positioning (DRVA/DDRVA) instruction	
Table operation (TBL <sup>*1</sup> /DRVTBL/DRVMUL) instruction	

\*1 Only CPU module is supported.

## 2-speed positioning

The 1-speed positioning of table 1 (excluding the deceleration stop) is performed by the table operation instruction. (Page 350 1-speed positioning) After the target position is reached, the 1-speed positioning of table 2 is performed from acceleration/deceleration.

2-speed positioning is performed when two 1-speed positionings are operated continuously by the continuous operation of the DRVTBL/DRVMUL instruction. Both relative address and absolute address can be used for the two 1-speed positionings.

(Page 521 Continuous operation)

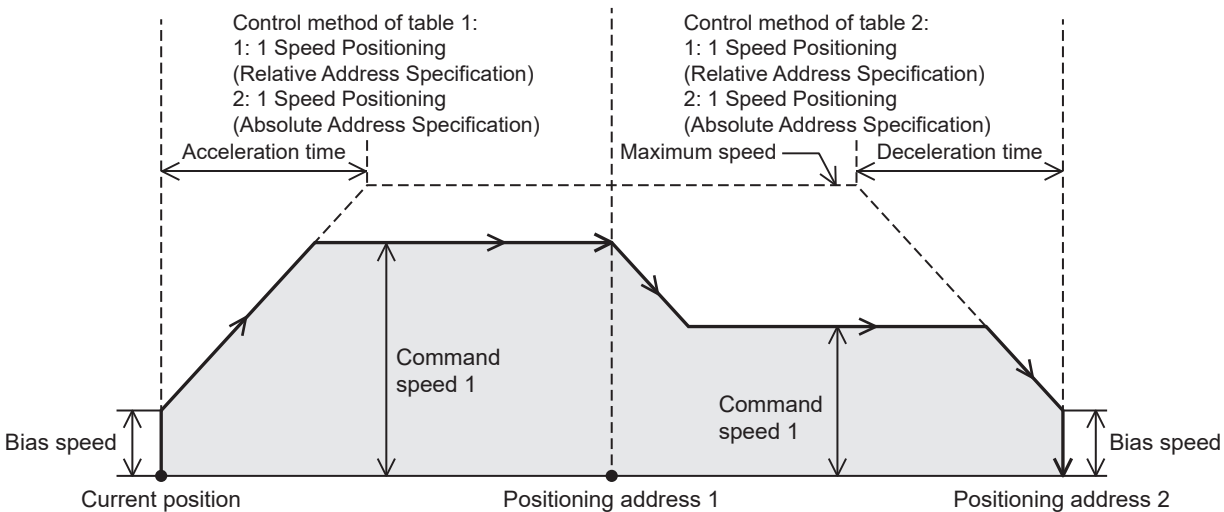

The following table shows applicable control methods of the table operation.

Positioning instruction	Table operation control method
Table operation (DRVTBL/DRVMUL) instruction	<ul style="list-style-type: none"> <li>• 1: 1 Speed Positioning (Relative Address Specification)</li> <li>• 2: 1 Speed Positioning (Absolute Address Specification)</li> </ul>



# Multi-speed operation

1-speed positioning operation (excluding the deceleration stop) is continued several times by the table operation instruction. (Page 350 1-speed positioning) At the last table, the operation decelerates and stops in the point that the speed can be reduced.

The multi-speed positioning is performed when two or more 1-speed positionings are operated continuously by the continuous operation of the DRV TBL/DRV MUL instruction. (Page 521 Continuous operation) Both relative address and absolute address can be used for the 1-speed positionings. The figure shows an example of a 4-speed operation.

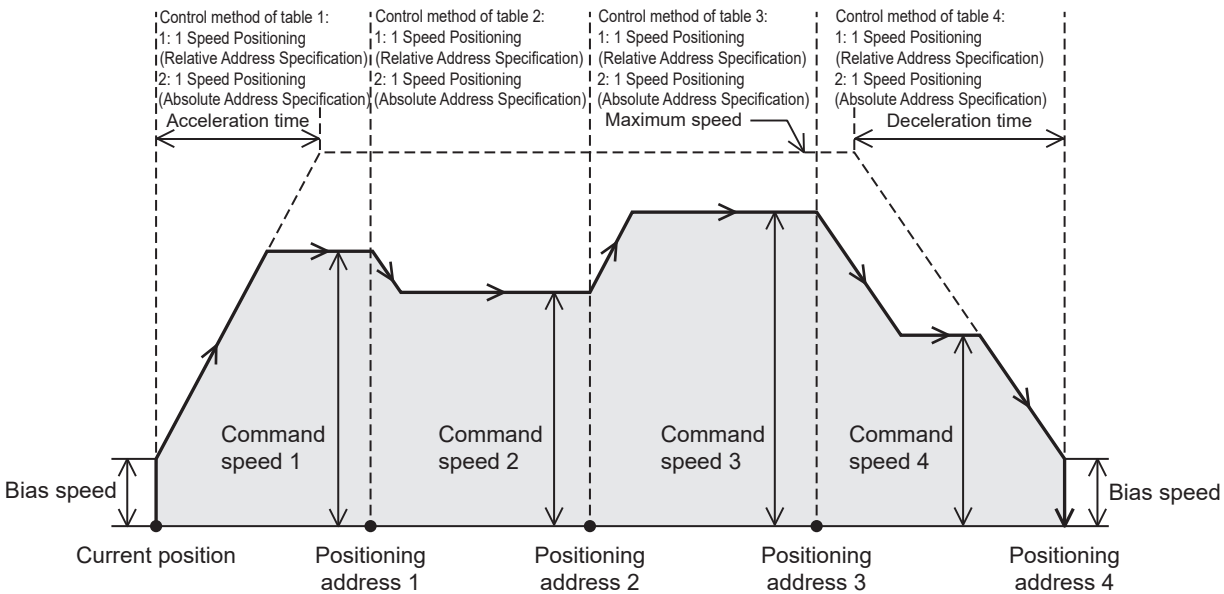

The following table shows applicable control methods of the table operation.

Positioning instruction	Table operation control method
Table operation (DRV TBL/DRV MUL) instruction	<ul style="list-style-type: none"> <li>• 1: 1 Speed Positioning (Relative Address Specification)</li> <li>• 2: 1 Speed Positioning (Absolute Address Specification)</li> </ul>

# Interrupt stop

1-speed positioning is performed by the table operation instruction. (Page 350 1-speed positioning) When the interruption input signal 1 is detected during pulse output operation, the operation decelerates and stops. (Page 381 Interrupt Input Signal 1) Both relative address and absolute address can be used for the interrupt stop.

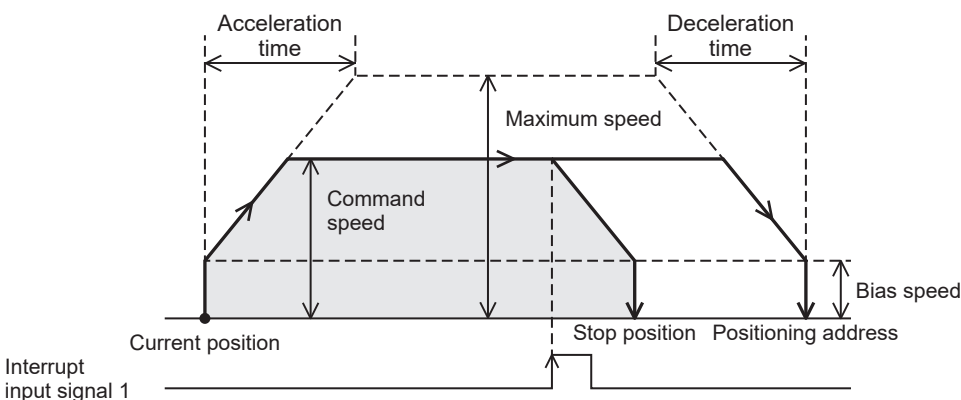

The following table shows applicable control methods of the table operation.

Positioning instruction	Table operation control method
Table operation (TBL*1/DRV TBL/DRV MUL) instruction	<ul style="list-style-type: none"> <li>• 6: Interrupt Stop (Relative Address Specification)</li> <li>• 7: Interrupt Stop (Absolute Address Specification)</li> </ul>

\*1 Only CPU module is supported.

## Precautions

When the interrupt input signal 1 does not turn on, the operation is the same as the 1-speed positioning.

## Interrupt 1-speed positioning

Acceleration is started at the bias speed when pulses are output by the positioning instruction. After the speed has reached the specified speed, the operation will be performed at the specified speed. When the interrupt input signal 1 is detected, the operation continues at the same speed as the command speed up to the point that deceleration must be performed, and decelerates and stops the pulse output at the position specified by the positioning address. (Page 381 Interrupt Input Signal 1)

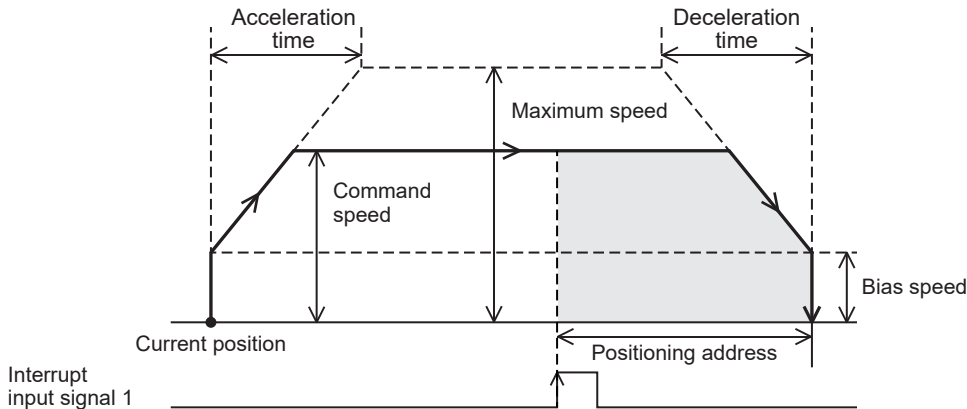

The following table shows applicable positioning instructions and control methods of the table operation.

Positioning instruction	Table operation control method
Interrupt 1-speed positioning (DVIT/DDVIT) instruction	3: Interrupt 1 Speed Positioning
Table operation (TBL* <sup>1</sup> /DRV TBL/DRVMUL) instruction	

\*1 Only CPU module is supported.

## Precautions

The pulse output is not stopped unless the interrupt input signal 1 is turned on.

When using continuous operation of the table operation instruction, the interrupt 1-speed positioning can be used only when the previous table is set to Table Transition Variable Speed Operation.

## Interrupt 2-speed positioning

The variable speed operation of table 1 is performed by the table operation instruction. (Page 354 Variable speed operation) When the interrupt input signal 2 is turned on, the interrupt 1-speed positioning of table 2 is performed from acceleration/deceleration. (Page 352 Interrupt 1-speed positioning) The operation command speed can be changed until the interrupt input signal 2 turns on.

Interrupt 2-speed positioning is achieved when control method [5: Table Transition Variable Speed Operation] is transferred to control method [3: Interrupt 1 Speed Positioning] by the table operation instruction.

Only CPU module is supported.

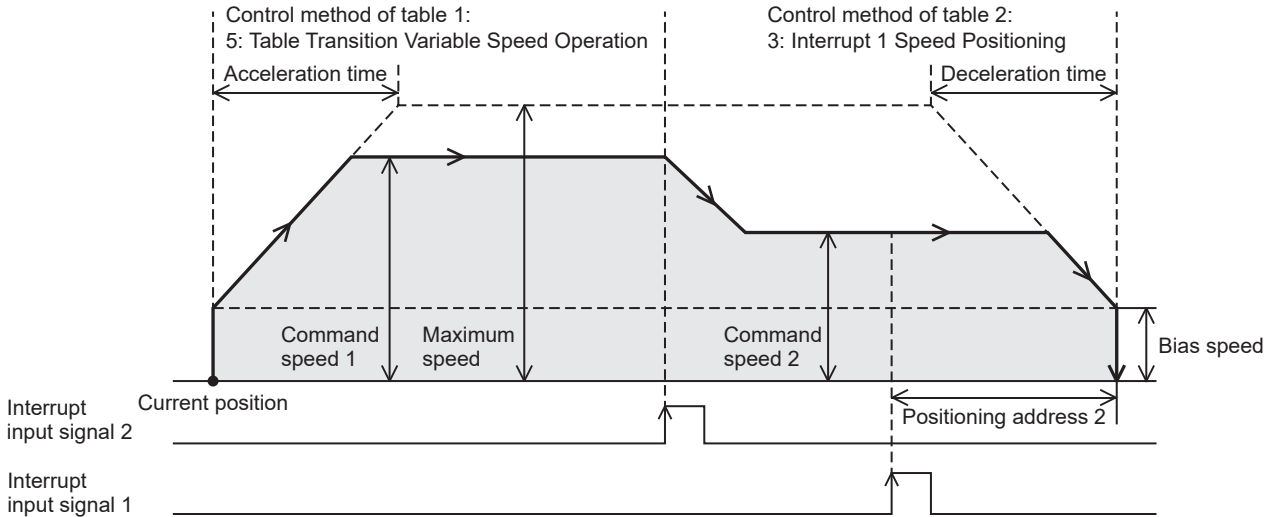

The following table shows applicable control methods of the table operation.

Positioning instruction	Table operation control method
Table operation (TBL <sup>*1</sup> /DRV TBL/DRVMUL) instruction	<ul style="list-style-type: none"> <li>• 5: Table Transition Variable Speed Operation<sup>*1</sup></li> <li>• 3: Interrupt 1 Speed Positioning</li> </ul>

\*1 Only CPU module is supported.

### Precautions

- The pulse output is not stopped unless the interrupt input signal 1 and 2 are turned on.
- When 0 is set for the command speed in the Table Transition Variable Speed Operation, the operation decelerates and stops. When the drive contact of the table operation instruction is on, the operation can be restarted when the command speed is set again.

### Point

For the high-speed pulse input/output module, substitution for the interrupt 2-speed positioning is possible by changing the command speed in mid-operation (Page 360 Command speed change during positioning operation) of the interrupt 1-speed positioning.

# Variable speed operation

Acceleration is started at the bias speed when pulses are output by the positioning instruction. After the speed has reached the specified speed, the operation will be performed at the specified speed. When the command speed is changed, the operation can change the speed to the specified speed. When the drive contact of the positioning instruction turns off, the operation decelerates and stops. The pulse output at the command speed is not stopped unless the instruction drive contact is turned off.

When setting 0 for the acceleration time and the deceleration time, speed change will be performed without the acceleration/ deceleration operation.

■With acceleration/deceleration operation

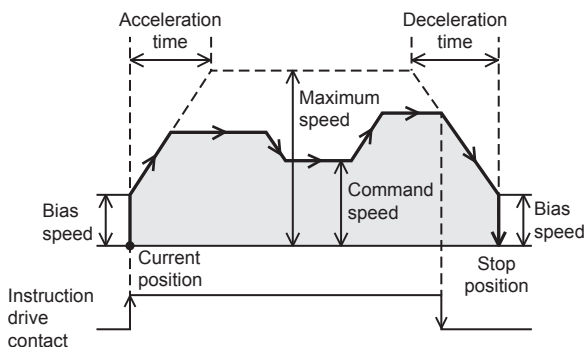

■Without acceleration/deceleration (0 is set to the acceleration time and the deceleration time.)

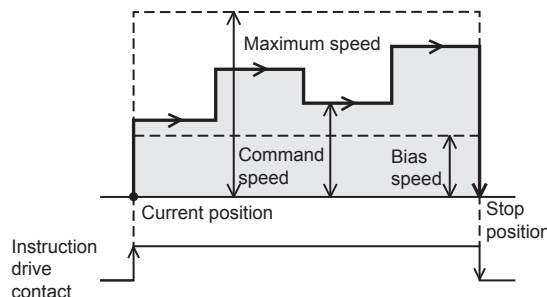

The following table shows applicable positioning instructions and control methods of the table operation.

Positioning instruction	Table operation control method
Variable speed operation (PLSV/DPLSV) instruction	4: Variable Speed Operation
Table operation (TBL <sup>*1</sup> /DRV TBL/DRVMUL) instruction	

\*1 Only CPU module is supported.

## Precautions

When 0 is set for the command speed, the operation decelerates and stops (when 0 is set for the deceleration time, the operation stops immediately). When the drive contact of the positioning instruction is on, the operation can be restarted when the command speed is set again.

## Table operation

A positioning control program can be set with the table set in GX Works3. The specified table operation is started by the table operation instruction.

The TBL instruction performs the operation of a single table, the DRV TBL instruction performs the stepping operation and continuous operation of multiple tables, and the DRVMUL instruction can handle tables of multiple axes (continuous operation possible). (Page 519 Stepping operation, Page 521 Continuous operation)

However, the TBL instruction is available only for the CPU module.

For details of the table operation, refer to Page 487 TABLE OPERATION.

No.	Device	Control Method	Axis to be Interpolated	Positioning Address	Command Speed	Dwell Time	Interrupt Counts	Interrupt Input Signal 2 Device No.	Jump Destination Table No.	M No. for Jump Condition
1	D100	4: Variable Speed Operation	Axis 2 Specification	0 pulse	10000 pps	0 ms	1 Times	X0	1	0
2	D106	1: 1 Speed Positioning (Relative Address Specification)	Axis 2 Specification	100000 pulse	30000 pps	0 ms	1 Times	X0	1	0
3	D112	1: 1 Speed Positioning (Relative Address Specification)	Axis 2 Specification	-10000 pulse	2000 pps	0 ms	1 Times	X0	1	0
4	D118	1: 1 Speed Positioning (Relative Address Specification)	Axis 2 Specification	20000 pulse	140000 pps	0 ms	1 Times	X0	1	0
5	D124	0: No Positioning	Axis 2 Specification	0 pulse	1 pps	0 ms	1 Times	X0	1	0
6	D130	0: No Positioning	Axis 2 Specification	0 pulse	1 pps	0 ms	1 Times	X0	1	0
7	D136	0: No Positioning	Axis 2 Specification	0 pulse	1 pps	0 ms	1 Times	X0	1	0
8	D142	0: No Positioning	Axis 2 Specification	0 pulse	1 pps	0 ms	1 Times	X0	1	0
9	D148	3: Interrupt 1 Speed Positioning	Axis 2 Specification	30000 pulse	100000 pps	10 ms	1 Times	X0	1	0
10	D154	3: Interrupt 1 Speed Positioning	Axis 2 Specification	2000 pulse	20000 pps	10 ms	1 Times	X0	1	0
⋮	⋮	⋮	⋮	⋮	⋮	⋮	⋮	⋮	⋮	⋮

## Simple linear interpolation operation (2-axis simultaneous start)

The work piece will travel to the target position at the specified vector speed (interpolation operation) by the table operation instruction. In this interpolation operation of two axes, the CPU module calculates the start timing based on the positioning address and the command speed set in the table. The interpolation speed can be specified by combined speed and reference-axis speed. (Page 395 Interpolation Speed Specified Method) For maximum speed, bias speed, the acceleration time, and deceleration time, use the reference-axis setting.

Only FX5S/FX5U/FX5UC CPU module and high-speed pulse input/output module support this operation.

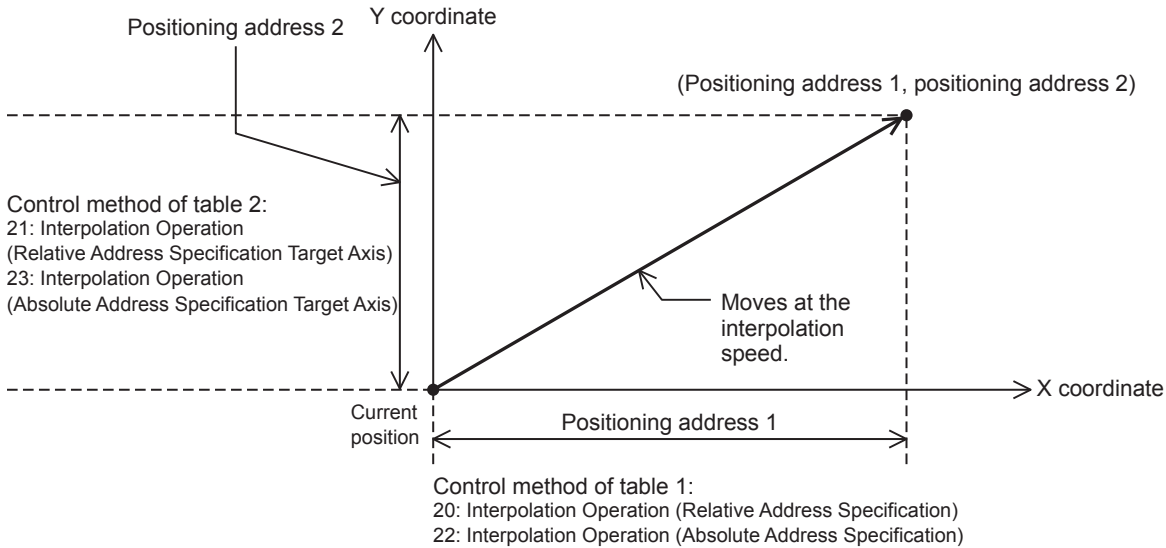

The following table shows applicable control methods of the table operation.

Positioning instruction	Table operation control method
Table operation (TBL <sup>*1</sup> /DRV TBL/DRVMUL) instruction	<ul style="list-style-type: none"> <li>• 20: Interpolation Operation (Relative Address Specification)</li> <li>• 21: Interpolation Operation (Relative Address Specification Target Axis)</li> <li>• 22: Interpolation Operation (Absolute Address Specification)</li> <li>• 23: Interpolation Operation (Absolute Address Specification Target Axis)</li> </ul>

\*1 Only CPU module is supported.

### Precautions

The 2 axes used must be from the same module. (Example. The combination of a reference-axis in the CPU module and a counterpart axis in a high-speed pulse input/output module is not allowed.)

## 30.4 Auxiliary Function

This section describes auxiliary functions of the positioning.

### Dog search function

If the forward rotation limit and the reverse rotation limit are used, the DOG search function can be used for OPR. (Page 359 Forward limit and reverse limit) The OPR operation depends on the OPR start position.

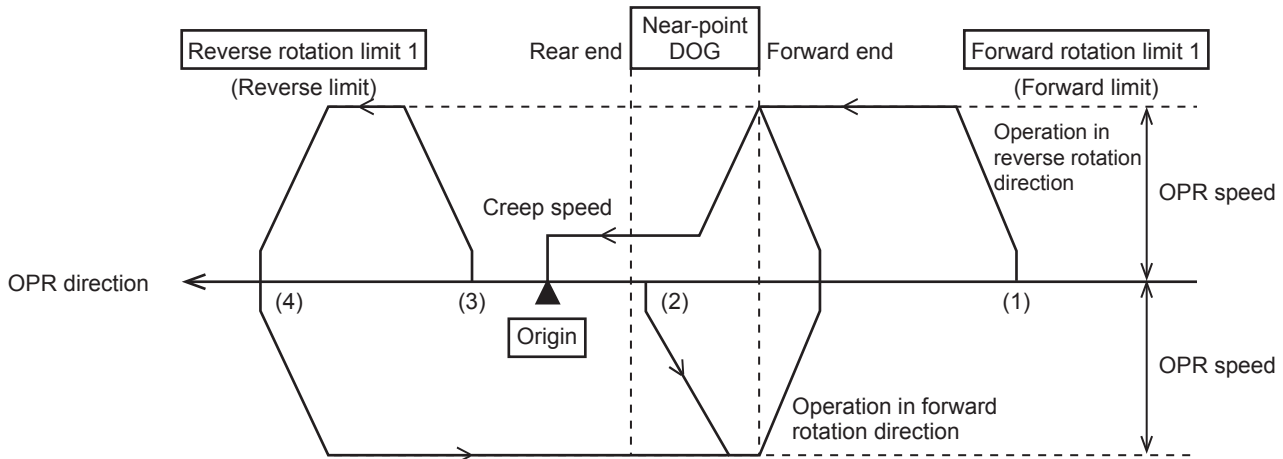

#### (1) If the start position is before the near-point dog:

1. When the DSZR/DDSZR instruction is executed, OPR will be started.
2. Transfer operation will be started in the OPR direction at the OPR speed.
3. If the front end of the near-point dog is detected, the speed will be reduced to the creep speed.
4. After detecting the rear end of the near-point dog, if the zero signal is detected for the specified number of times is detected, the operation will be stopped.

#### (2) If the start position is in the near-point dog area:

1. When the DSZR/DDSZR instruction is executed, OPR will be started.
2. Transfer operation will be started in the opposite direction of the OPR speed.
3. If the front end of the near-point dog is detected, the speed will decelerate and the operation will stop. (The workpiece will come out of the near-point dog area.)
4. Transfer operation will be started in the OPR direction at the OPR speed. (The workpiece will enter the near-point dog area again.)
5. If the front end of the near-point dog is detected, the speed will be reduced to the creep speed.
6. After detecting the rear end of the near-point dog, if the zero signal is detected for the specified number of times is detected, the operation will be stopped.

### (3) If the start position is after the near-point dog:

1. When the DSZR/DDSZR instruction is executed, OPR will be started.
2. Transfer operation will be started in the OPR direction at the OPR speed.
3. If the reverse rotation limit 1 (reverse rotation limit) is detected, the speed will decelerate, and the operation will stop.
4. Transfer operation will be started in the opposite direction of the OPR direction at the OPR speed.
5. If the front end of the near-point dog is detected, the speed will decelerate and the operation will stop. (The workpiece will detect (come out) the near-point dog area.)
6. Transfer operation will be started in the OPR direction at the OPR speed. (The workpiece will enter the near-point dog area again.)
7. If the front end of the near-point dog is detected, the speed will be reduced to the creep speed.
8. After detecting the rear end of the near-point dog, if the zero signal is detected for the specified number of times is detected, the operation will be stopped.

### (4) If the limit switch in the OPR direction turns on (if the start position is at reverse rotation limit 1):

1. When the DSZR/DDSZR instruction is executed, OPR will be started.
2. Transfer operation will be started in the opposite direction of the OPR direction at the OPR speed.
3. If the front end of the near-point dog is detected, the speed will decelerate and the operation will stop. (The workpiece will detect (come out) the near-point dog area.)
4. Transfer operation will be started in the OPR direction at the OPR speed. (The workpiece will enter the near-point dog area again.)
5. If the front end of the near-point dog is detected, the speed will be reduced to the creep speed.
6. After detecting the rear end of the near-point dog, if the zero signal is detected for the specified number of times is detected, the operation will be stopped.

#### **Point**

When the same device is specified for the near-point dog signal and the zero signal and OPR zero signal counts is 1, OPR is stopped when the OPR is completed by the near-point dog signal detection, not by the zero signal detection. When the timing of counting start of the number of zero signals is set to the front end of near-point dog, the number of zero signals is counted from when the near-point dog signal is detected.

# Dwell time

Set the time (dwell time) until the complete flag turns on after positioning operation is completed between 0 and 32767 ms. (Page 400 Complete flag) When the positioning operation is completed, the complete flag remains off until the dwell time has elapsed.

Dwell time applies to the DSZR/DDSZR instruction and the table operation instruction. If the CLEAR signal is output by the DSZR/DDSZR instruction, the dwell time applies when the CLEAR signal turns off.

Set the dwell time of DSZR/DDSZR instruction with the positioning parameter. (Page 390 OPR Dwell Time) Set the dwell time of the table operation instruction for the control method of each table with the table operation parameter. (Page 393 Dwell Time)

## ■OPR (DSZR/DDSZR) instruction

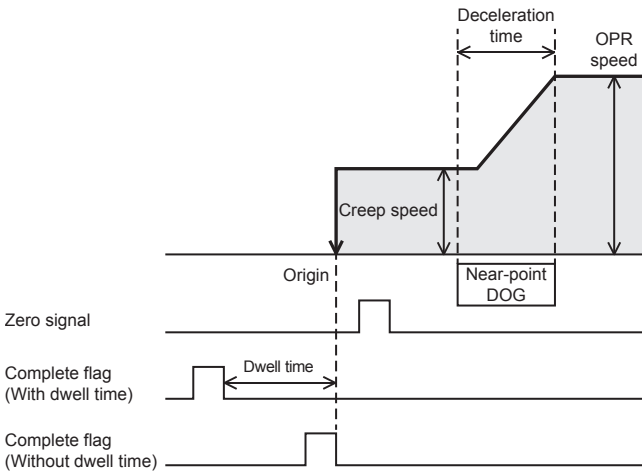

## ■Table operation instruction (control method: [1 Speed Positioning])

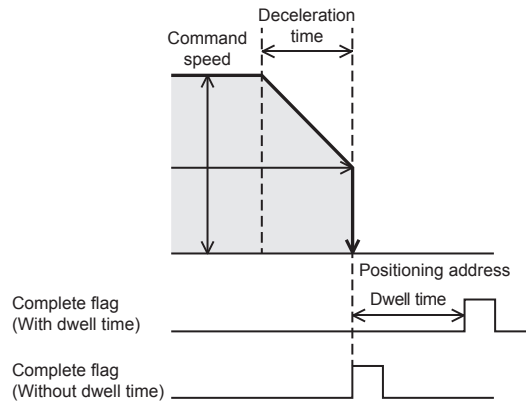

# OPR zero signal count

When the DSZR/DDSZR instruction is used, the OPR zero signal counts is counted after the zero signal count start timing. (Page 391 Zero Signal) When the number of the zero signals has reached specified number, pulse output is stopped. The setting range is from 0 to 32767. When not counting the OPR zero signal counts, set 1. The pulse output is stopped when the OPR zero signal counts has reached specified number even during the deceleration operation.

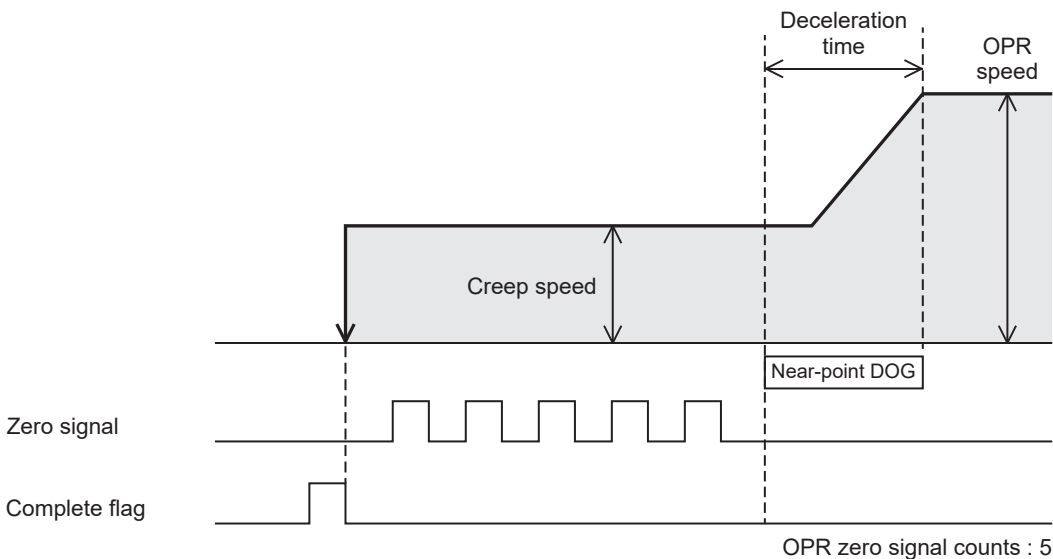

## Precautions

When the OPR zero signal counts is set to 0, the motor stops immediately after the forward end or rear end (selected by parameter) of near-point dog is detected. Note that immediate stop may damage the machine because the motor stops immediately.



## Forward limit and reverse limit

When using the servo motor, the forward rotation limit and the reverse rotation limit can be set for the servo amplifier. To use the DOG search function for OPR, or to set the forward rotation limit or the reverse rotation limit for operations other than OPR using the CPU module, set the forward rotation limit 1 (LSF) and reverse rotation limit 1 (LSR) for the CPU module so that these limit switches can be activated before the forward rotation limit 2 or reverse rotation limit 2 of the servo amplifier. As shown in the following figure, interlock the forward rotation limit 1 (LSF) with the forward limit, and the reverse rotation limit 1 (LSR) with the reverse limit.

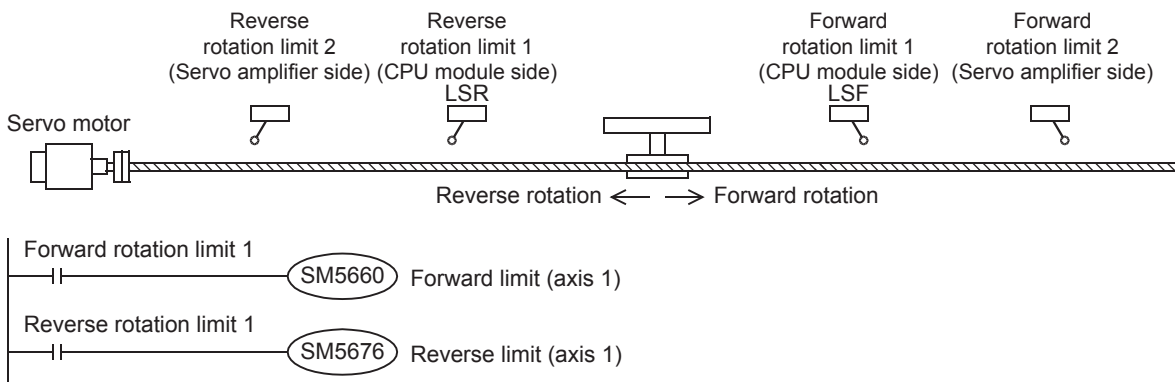

The following table lists the corresponding devices. Related devices of axis 4 are available only for the FX5S/FX5U/FX5UC CPU module.

Name	CPU module				High-speed pulse input/output module							
					First module		Second module		Third module		Fourth module	
	Axis 1	Axis 2	Axis 3	Axis 4	Axis 5	Axis 6	Axis 7	Axis 8	Axis 9	Axis 10	Axis 11	Axis 12
Forward limit	SM5660	SM5661	SM5662	SM5663	SM5664	SM5665	SM5666	SM5667	SM5668	SM5669	SM5670	SM5671
Reverse limit	SM5676	SM5677	SM5678	SM5679	SM5680	SM5681	SM5682	SM5683	SM5684	SM5685	SM5686	SM5687

### Precautions

If the forward rotation limit 1 (LSF) and the reverse rotation limit 1 (LSR) cannot be set, observe the following items:

- Even if forward rotation limit 2 or reverse rotation limit 2 turns on and the servo motor is automatically stopped, the positioning instruction currently being driven cannot recognize the motor being stopped. Therefore, pulses will be continuously output until the instruction is deactivated.
- The dog search function cannot be used.

## Positioning address change during positioning operation

This function changes positioning address during positioning operation.

- For positioning instructions, by specifying a word device as an operand and changing the value, positioning address can be changed during positioning operation.
- For the table operation, by setting the positioning table data in devices and changing the operand value of the control method of a table, positioning address can be changed during positioning operation. Only the last table can be changed in the case of continuous operation.

The changed value is applied when the positioning instruction is executed at the next scan.

The following table shows applicable positioning instructions and control methods of the table operation.

Positioning instruction	Table operation control method
Pulse Y output (PLSY/DPLSY) instruction*1	<ul style="list-style-type: none"> <li>• 1: 1 Speed Positioning (Relative Address Specification)</li> <li>• 2: 1 Speed Positioning (Absolute Address Specification)</li> <li>• 3: Interrupt 1 Speed Positioning</li> <li>• 6: Interrupt Stop (Relative Address Specification)</li> <li>• 7: Interrupt Stop (Absolute Address Specification)</li> </ul>
Relative positioning (DRVI/DDRVI) instruction	
Absolute positioning (DRVA/DDRVA) instruction	
Interrupt 1-speed positioning (DVIT/DDVIT) instruction	
Table operation (TBL*1/DRV TBL/DRVMUL) instruction	

\*1 Only CPU module is supported.

## Precautions

- The current address at start of a positioning instruction is used as the basis, thus, positioning operation is performed with the current address at startup as the basis even when the positioning address is changed during positioning operation.
- The PLSY/DPLSY instruction is stopped immediately when set to a value equal to or less than the number of pulses that have been already output.
- If the positioning address is changed to a value that reverses the current rotation direction, the rotation direction is reversed\*<sup>2</sup> after deceleration stop and the positioning is started for the positioning address.
- When an address that positioning address cannot decelerate in time is set, the transfer direction is reversed\*<sup>2</sup> after deceleration stop and the positioning is started for the positioning address.
- A reversed operation makes it impossible to change the positioning address during positioning operation until positioning operation is reactivated.
- When positioning address is changed to a large remaining transfer distance during the deceleration operation with small remaining transfer distance, the positioning operation is performed after re-acceleration.
- When the transfer distance from the current address exceeds -2147483648 to +2147483647 in pulse in the positioning operation with relative address specification, the operation ends with an error after deceleration stop.
- If a table other than the last one is changed in the case of continuous operation, the change may not be reflected on the operation correctly.

\*2 The waiting time for the pulse reverse after deceleration stop is "1 ms + scan time". Set the new positioning address after confirming that it does not affect the system. At this time, pulse output in the reversed direction is started regardless of the dwell time.

## Command speed change during positioning operation

This function changes operation speed during positioning operation.

- For positioning instructions, by specifying a word device as an operand that specifies the command speed (for the DSZR/ DDSZR instruction, the OPR speed and the creep speed) and changing the value, operation speed can be changed during operation.
- For the table operation, by setting the positioning table data in devices and changing the operand value of the corresponding control method, command speed can be changed during positioning operation.

The changed value is applied when the positioning instruction is executed at the next scan.

The following table shows applicable positioning instructions and control methods of the table operation.

Positioning instruction	Table operation control method
Pulse Y output (PLSY/DPLSY) instruction* <sup>1</sup>	<ul style="list-style-type: none"> <li>• 1: 1 Speed Positioning (Relative Address Specification)</li> <li>• 2: 1 Speed Positioning (Absolute Address Specification)</li> <li>• 3: Interrupt 1 Speed Positioning*<sup>3</sup></li> <li>• 4: Variable Speed Operation</li> <li>• 5: Table Transition Variable Speed Operation*<sup>1</sup></li> <li>• 6: Interrupt Stop (Relative Address Specification)*<sup>3</sup></li> <li>• 7: Interrupt Stop (Absolute Address Specification)*<sup>3</sup></li> </ul>
Mechanical OPR (DSZR/DDSZR) instruction* <sup>2</sup>	
Relative positioning (DRVI/DDRVI) instruction	
Absolute positioning (DRVA/DDRVA) instruction	
Interrupt 1-speed positioning (DVIT/DDVIT) instruction* <sup>3</sup>	
Variable speed operation (PLSV/DPLSV) instruction	
Table operation (TBL* <sup>1</sup> /DRV TBL/DRVMUL) instruction	

\*1 Only CPU module is supported.

\*2 A change in the command speed after the zero signal is detected is applied when the positioning instruction is next driven again.

\*3 A change in the command speed after the interrupt input signal 1 is detected is applied when the positioning instruction is next driven again.

## Precautions

- When command speed is lower than bias speed, the bias speed is applied. The PLSY/DPLSY instruction, PLSV/DPLSV instruction and the table operation instruction (control method: [4: Variable Speed Operation] or [5: Table Transition Variable Speed Operation]) can be changed to lower than the bias speed.
- Do not change command speed to 200 kpps or more in pulse. For the FX5S CPU module, the command speed must be less than 100 kpps in pulse.
- If the creep speed is changed to a speed equal to or faster than the OPR speed during operation at creep speed by the DSZR/DDSZR instruction, the speed is changed to the OPR speed.
- For instruction or control method other than the PLSY/DPLSY instruction, PLSV/DPLSV instruction and the table operation instruction (control method: [4: Variable Speed Operation] or [5: Table Transition Variable Speed Operation]), do not set 0 for the command speed. The operation ends with an error.
- If the command speed is changed to 0 during PLSY/DPLSY instruction operation, the operation does not end with error but it immediately stops. As long as the drive contact is on, changing the command speed restarts pulse output. However, if the command speed is changed to negative value during operation, the operation ends with an error.
- If the command speed of the PLSV/DPLSV instruction or the table operation instruction (control method: [4: Variable Speed Operation] or [5: Table Transition Variable Speed Operation]) is changed to 0 during operation, the operation does not end with error but it decelerates to a stop. As long as the drive contact is on, changing the command speed restarts pulse output.
- If the speed is changed to reverse the rotation direction, pulses are output inversely after deceleration stop. The waiting time for the pulse reverse after deceleration stop is "1 ms + scan time". Set the new command speed after confirming that it does not affect the system.
- When operation speed is changed for acceleration with small remaining travel distance, the speed is increased to a speed at which deceleration stop is still possible (the operation is not performed at the changed speed), then decelerates.

## Pulse decelerate and stop

When the pulse decelerate and stop command is turned on during positioning operation, the positioning operation can be decelerated and stopped. (📖 Page 383 Pulse decelerate and stop command) When positioning operation is stopped by the pulse decelerate and stop command, remaining distance operation can be performed with positioning instructions. (📖 Page 362 Remaining distance operation)

The following table lists the corresponding devices. Related devices of axis 4 are available only for the FX5S/FX5U/FX5UC CPU module.

Name	CPU module				High-speed pulse input/output module							
					First module		Second module		Third module		Fourth module	
	Axis 1	Axis 2	Axis 3	Axis 4	Axis 5	Axis 6	Axis 7	Axis 8	Axis 9	Axis 10	Axis 11	Axis 12
Pulse decelerate and stop command	SM5644	SM5645	SM5646	SM5647	SM5648	SM5649	SM5650	SM5651	SM5652	SM5653	SM5654	SM5655

## Precautions

- When this function is used with remaining distance operation-compatible instructions with remaining distance operation enabled and non-table operation control method (other than remaining distance operation), the operation ends with an error.
- PLSY/DPLSY instruction stops immediately.
- For the PLSV/DPLSV instruction and table operation instruction (control method: [4: Variable Speed Operation] or [5: Table Transition Variable Speed Operation]), the operation ends normally. When operation is performed without acceleration/ deceleration operation, the operation stops immediately.
- When this function is used during stepping operation and the table operation instruction (control method: [4: Variable Speed Operation] or [5: Table Transition Variable Speed Operation]), the following table is activated after deceleration stop.

## Remaining distance operation

When pulse output is stopped by the pulse decelerate and stop command during positioning instruction operation and the remaining distance operation enabled is ON, the remaining distance operation ready status is acquired. (Page 385 Remaining distance operation, Page 361 Pulse decelerate and stop) When the pulse decelerate and stop command turns off, the remaining distance operation starts. Or if the external start signal (when enabled) is detected, remaining transfer amount from deceleration stop is output. After the remaining distance operation is completed, the complete flag turns on. (Page 383 External Start Signal)

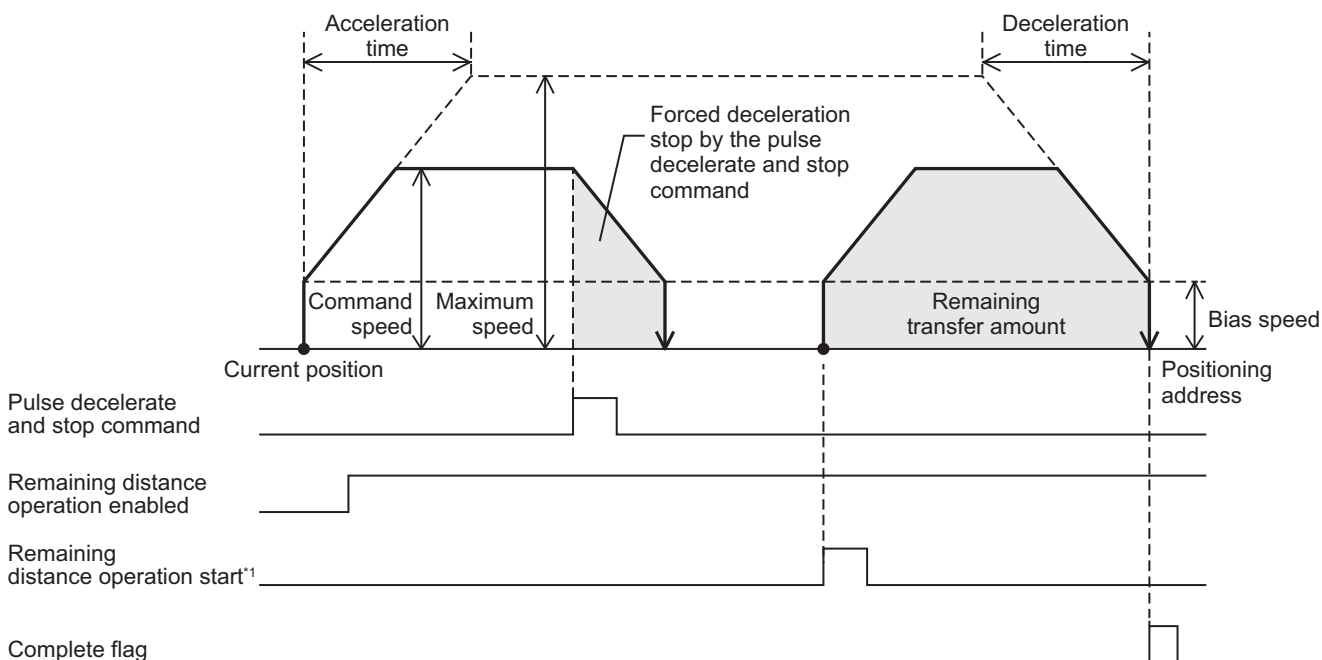

\*1 The external start signal can start the remaining distance operation as well.

The following table shows applicable positioning instructions and control methods of the table operation.

Positioning instruction	Table operation control method
Relative positioning (DRVI/DDRVI) instruction	• 1: 1 Speed Positioning (Relative Address Specification)
Absolute positioning (DRVA/DDRVA) instruction	• 2: 1 Speed Positioning (Absolute Address Specification)
Table operation (TBL*2/DRV TBL/DRVMUL) instruction	• 6: Interrupt Stop (Relative Address Specification) • 7: Interrupt Stop (Absolute Address Specification)

\*2 Only CPU module is supported.

Changes to the positioning address and command speed during positioning operation are valid until the system starts deceleration stop under the pulse decelerate and stop command. After deceleration stop, changes are applied when the positioning instruction is started again.

When dwell time is set, and the remaining distance operation start command is turned on immediately after deceleration stop, remaining distance operation is started regardless of the dwell time.

### Precautions

- Where the system starts the remaining distance operation after changing the positioning address under the relative address specification, positioning operation is performed with the current address at start of the positioning or table instruction as the basis.
- After the interrupt input signal 1 is detected, the table operation instruction (control method: [6: Interrupt Stop (Relative Address Specification)] or [7: Interrupt Stop (Absolute Address Specification)]) becomes unable to execute the remaining distance operation.
- For positioning instructions or control methods of the table operation that are not compatible with the remaining distance operation, only deceleration stop is performed. The operation ends with an error. For the PLSV/DPLSV instruction and table operation instruction (control method: [4: Variable Speed Operation] or [5: Table Transition Variable Speed Operation]), after the deceleration stop the operation ends normally.
- When the operation is stopped by other than the pulse decelerate and stop command remaining distance operation enabled is ON, the operation ends with an error. (Page 404 Pulse output stop)

## Multiple axes simultaneous activation

---

Tables for up to 4 axes can be activated at the same time with the DRVMUL instruction. Continuous operation can be performed. (☞ Page 521 Continuous operation) After the operation is started, each axis operates independently, thus, table shift timing during continuous operation does not need to be considered.

### Precautions

- The axes to be driven simultaneously must be from the same module. (Example. The combination of axis 1 and axis 2 in the CPU module and axis 5 and axis 6 in a high-speed pulse input/output module is not allowed.)
- 3 axes can be simultaneously driven for the FX5UJ CPU module.
- 2 axes can be simultaneously driven for the high-speed pulse input/output module.

## Detection of absolute position

---

The absolute position (ABS) data of the servo amplifier can be read with the DABS instruction.  
For the absolute position detection operation, refer to ☞ Page 484 Outline of operation.

## All module reset when a stop error occurs

---

When the system intends to stop the pulse output but fails to do so due to a bus error, this function resets all the extension modules while immediately stopping the pulse output. (☞ Page 383 Enabled/Disabled Reset All Modules at Error Stop)  
For supported versions for all module reset when a stop error occurs, refer to ☞ Page 966 Added and Enhanced Functions.

30

### Point

In addition, all modules are reset when the following conditions are satisfied.

- All module reset instruction (SM4210) is turned ON
- F5F5H (reset permission code) is stored in the all module reset instruction permission code (SD4210)

### Precautions

An error occurs when stop by reset. To restart operation of the extension module, turn the power of the CPU module from off to on or reset the system.

# 31 POSITIONING PARAMETER

This chapter describes the parameters for the positioning function and relevant devices.

Set the parameters of the positioning using the high speed I/O parameter, operand, and special devices.

For the parameters of the table operation, refer to [Page 487 TABLE OPERATION](#).

## 31.1 Setting Method

The following list shows the setting methods for the positioning parameter.

### High Speed I/O Parameter

High speed I/O parameter settings can be made from GX Works3. The following describes the details of the positioning setting.

- Basic Setting ([Page 365 Basic setting](#))
- Axis #1 Positioning Data to Axis #12 Positioning Data ([Page 487 Table setting method](#))
- Input Check ([Page 368 Input check](#))
- Output Confirmation ([Page 369 Output check](#))

### Operand

The command speed or positioning address can be set by operand for each positioning instruction or control method for table operation. When specifying a word device (if table operation, when the positioning table data is set to use device) as an operand, the value can be changed during operation. For the details of operand, refer to the following.

[Page 402 POSITIONING INSTRUCTION](#)

[Page 487 TABLE OPERATION](#)

### Special Device

Values of special devices for positioning parameters can be read or written from engineering tool or program. Changes to the special devices during positioning operation are applied when the positioning instruction is started again. However, the changed pulse output stop command, pulse decelerate and stop command, forward limit, reverse limit, table shift command, remaining distance operation enabled and remaining distance operation start are applied in the next scan.

The values of special devices for positioning parameters can be also read or written to by high-speed current value transfer (HCMOV/DHCMOV) instruction and data transfer (MOV/DMOV) instructions.

For the details of special device that can be read or written to, refer to the following.

[Page 370 Details of Parameters](#)

[Page 772 Special Relay List](#)

# Basic setting

The items set in basic setting correspond to the positioning parameters of each axis. In special devices corresponding to parameters, values set in the basic setting are stored as the initial values when the power of CPU module is STOP→RUN. When items occupying I/O are changed, the high speed I/O assignment parameters are also refreshed together.

For parameters, refer to Page 370 Details of Parameters.

## Window

### ■ CPU module

[Navigation window] ⇒ [Parameter] ⇒ Module model name ⇒ [Module Parameter] ⇒ [High Speed I/O] ⇒ [Output Function] ⇒ [Positioning] ⇒ [Detailed Setting] ⇒ [Basic Settings]

Item	Axis1	Axis2	Axis3	Axis4
<b>Basic Parameter 1</b>	<b>Set basic parameter 1.</b>			
— Pulse Output Mode	2CW/CCW	1PULSE/SIGN	0: Not Used	1PULSE/SIGN
— Output Device (PULSE/CW)	Y0	Y1	Y2	Y3
— Output Device (SIGN/CCW)	Y2	Y5	Y6	Y7
— Rotation Direction Setting	0: Current Address Increment with Forward Run Pulse Output	1: Current Address Increment with Reverse Run Pulse Output	0: Current Address Increment with Forward Run Pulse Output	0: Current Address Increment with Forward Run Pulse Output
— Unit Setting	0: Motor System (pulse, pps)	1: Machine System (um, cm/min)	0: Motor System (pulse, pps)	2: Machine System (0.001 inch, inch/min)
— No. of Pulse per Rotation	2000 pulse	8000 pulse	2000 pulse	2000 pulse
— Movement Amount per Rotation	1000 pulse	2000 um	1000 pulse	1000 X 0.0001 inch
— Position Data Magnification	1: X Single	1: X Single	1: X Single	10 X 10 Times
<b>Basic Parameter 2</b>	<b>Set basic parameter 2.</b>			
— Interpolation Speed Specification Method	1: Reference Axis Speed	0: Composite Speed	0: Composite Speed	0: Composite Speed
— Max. Speed	120000 pps	200000 cm/min	100000 pps	150000 inch/min
— Bias Speed	1500 pps	1800 cm/min	0 pps	1000 inch/min
— Acceleration Time	1000 ms	1000 ms	100 ms	1000 ms
— Deceleration Time	100 ms	100 ms	100 ms	100 ms
<b>Detailed Setting Parameter</b>	<b>Set the detailed setting parameter.</b>			
— External Start Signal Enable/Disable	1: Valid	0: Invalid	0: Invalid	1: Valid
— External Start Signal Device No.	X0	X0	X0	X6
— External Start Signal Logic	0: Positive Logic	0: Positive Logic	0: Positive Logic	0: Positive Logic
— Interrupt Input Signal 1 Enable/Disable	0: Invalid	0: Invalid	0: Invalid	1: Valid
— Interrupt Input Signal 1 Mode	0: High Speed Mode	0: High Speed Mode	0: High Speed Mode	1: Standard Mode
— Interrupt Input Signal 1 Device No.	X0	X0	X0	X2
— Interrupt Input Signal 1 Logic	0: Positive Logic	0: Positive Logic	0: Positive Logic	0: Positive Logic
— Interrupt Input Signal 2 Logic	0: Positive Logic	0: Positive Logic	0: Positive Logic	1: Negative Logic
<b>OPR Parameter</b>	<b>Set the OPR parameter.</b>			
— OPR Enable/Disable	1: Valid	1: Valid	0: Invalid	0: Invalid
— OPR Direction	1: Positive Direction (Address Increment Direction)	0: Negative Direction (Address Decrement Direction)	0: Negative Direction (Address Decrement Direction)	0: Negative Direction (Address Decrement Direction)
— Starting Point Address	100 pulse	~10000 um	0 pulse	0 X 0.001 inch
— Clear Signal Output Enable/Disable	1: Valid	1: Valid	1: Valid	1: Valid
— Clear Signal Output Device No.	Y10	Y11	Y0	Y0
— OPR Dwell Time	0 ms	100 ms	0 ms	0 ms
— Near-point Dog Signal Device No.	X7	X10	X0	X0
— Near-point Dog Signal Logic	0: Positive Logic	1: Negative Logic	0: Positive Logic	0: Positive Logic
— Zero Signal Device No.	X4	X5	X0	X0
— Zero Signal Logic	0: Positive Logic	1: Negative Logic	0: Positive Logic	0: Positive Logic
— Zero Signal OPR Zero Signal Counts	1	1	1	1
— Zero Signal Count Start Time	0: Near-point Dog Latter Part	1: Near-point Dog Front Part	0: Near-point Dog Latter Part	0: Near-point Dog Latter Part

## High-speed pulse input/output module

Navigation window ⇒ Parameter ⇒ Module Information ⇒ Right-click ⇒ Add New Module

After adding the high-speed pulse input/output module, make settings on the screen displayed from the following operation.

Navigation window ⇒ Parameter ⇒ Module Information ⇒ 1 to 16 (high-speed input/output module) ⇒ Module Parameter ⇒ Output Function ⇒ Positioning ⇒ Detailed Setting ⇒ Basic Settings

Item	Axis5	Axis6
<b>Basic Parameter 1</b>	<b>Set basic parameter 1.</b>	
Pulse Output Mode	2: CW/CCW	1: PULSE/SIGN
Output Device (PULSE/CW)	Y20	Y21
Output Device (SIGN/CCW)	Y24	Y25
Rotation Direction Setting	0: Current Address Increment with Forward Run Pulse Output	1: Current Address Increment with Reverse Run Pulse Output
Unit Setting	0: Motor System (pulse, pps)	1: Machine System (um, cm/min)
No. of Pulse per Rotation	2000 pulse	3000 pulse
Movement Amount per Rotation	1000 pulse	2000 um
Position Data Magnification	1: X Single	1: X Single
<b>Basic Parameter 2</b>	<b>Set basic parameter 2.</b>	
Interpolation Speed Specification Method	1: Reference Axis Speed	0: Composite Speed
Max. Speed	120000 pps	200000 cm/min
Bias Speed	1500 pps	1800 cm/min
Acceleration Time	1000 ms	1000 ms
Deceleration Time	100 ms	100 ms
<b>Detailed Setting Parameter</b>	<b>Set the detailed setting parameter.</b>	
External Start Signal Enable/Disable	1: Valid	0: Invalid
External Start Signal Device No.	X27	X26
External Start Signal Logic	0: Positive Logic	0: Positive Logic
Interrupt Input Signal 1 Enable/Disable	0: Invalid	1: Valid
Interrupt Input Signal 1 Mode	0: High Speed Mode	0: High Speed Mode
Interrupt Input Signal 1 Device No.	X24	X23
Interrupt Input Signal 1 Logic	0: Positive Logic	0: Positive Logic
<b>OPR Parameter</b>	<b>Set the OPR parameter.</b>	
OPR Enable/Disable	1: Valid	1: Valid
OPR Direction	1: Positive Direction (Address Increment Direction)	0: Negative Direction (Address Decrement Direction)
Starting Point Address	100 pulse	-10000 um
Clear Signal Output Enable/Disable	1: Valid	1: Valid
Clear Signal Output Device No.	Y22	Y23
OPR Dwell Time	0 ms	100 ms
Near-point Dog Signal Device No.	X20	X21
Near-point Dog Signal Logic	0: Positive Logic	1: Negative Logic
Zero Signal Device No.	X25	X22
Zero Signal OPR Zero Signal Counts	1	1
Zero Signal Count Start Time	0: Near-point Dog Latter Part	0: Near-point Dog Latter Part
<b>Axis Common Parameter</b>	<b>Set the axis common parameter</b>	
Enable/Disable Reset All Modules at Error Stop	1: Valid	

Shown above is the screen at the time when the first high-speed pulse input/output module is selected.



## Parameter list

The following table lists the positioning parameters that can be set in Basic Setting.

Item	Setting value				Reference
	CPU module		High-speed pulse input/output module		
			Axis ■*4	Axis ■+1*4	
Basic Parameter 1					
Pulse Output Mode	0: Not Used, 1: PULSE/SIGN, 2: CW/CCW*1				Page 370
Output Device	PULSE/CW	FX5S/FX5U/FX5UC: Y0 to Y3*2*3 FX5UJ: Y0 to Y2*2	Y□*5	Y□+1*5	Page 371
	SIGN/CCW	Y0 to Y17*3	Y□+4*5	Y□+5*5	
Rotation Direction Setting	0: Current Address Increment with Forward Run Pulse Output, 1: Current Address Increment with Reverse Run Pulse Output				Page 372
Unit Setting	0: Motor System (pulse, pps) 1: Machine System (μm, cm/min) 2: Machine System (0.0001 inch, inch/min) 3: Machine System (mdeg, 10 deg/min) 4: Multiple System (μm, pps) 5: Multiple System (0.0001 inch, pps) 6: Multiple System (mdeg, pps)				Page 373
No. of Pulse per Rotation	1 to 2147483647				Page 374
Movement Amount per Rotation	1 to 2147483647				Page 374
Position Data Magnification	1: × Single, 10: × 10 Times, 100: × 100 Times, 1000: × 1000 Times				Page 375
Basic Parameter 2					
Interpolation Speed Specified Method*1	0: Composite Speed, 1: Reference Axis Speed				Page 395
Max. Speed	1 to 2147483647				Page 377
Bias Speed	0 to 2147483647				Page 377
Acceleration Time	0 to 32767 ms				Page 378
Deceleration Time	0 to 32767ms				Page 378
Detailed Setting Parameter					
External Start Signal	Enabled/Disabled	0: Disabled, 1: Enabled			Page 383
	Device No.	X0 to X17	X□+7*5	X□+6*5	
	Logic	0: Positive Logic, 1: Negative Logic			
Interrupt Input Signal 1	Enabled/Disabled	0: Disabled, 1: Enabled			Page 381
	Mode	0: High Speed Mode, 1: Standard Mode			
	Device No.	X0 to X17	X□+4*5	X□+3*5	
	Logic	0: Positive Logic, 1: Negative Logic			
Interrupt Input Signal 2 Logic	0: Positive Logic, 1: Negative Logic			—	Page 394
OPR Parameter					
OPR Enabled/Disabled	0: Disabled, 1: Enabled				Page 387
OPR Direction	0: Negative Direction (Address Decrement Direction), 1: Positive Direction (Address Increment Direction)				Page 387
Starting Point Address	-2147483648 to +2147483647				Page 388
Clear Signal Output	Enabled/Disabled	0: Disabled, 1: Enabled			Page 389
	Device No.	Y0 to Y17	Y□+2*5	Y□+3*5	Page 390
OPR Dwell Time	0 to 32767 ms				Page 390
Near-point Dog Signal	Device No.	X0 to X17	X0 to X377 (Optional)		Page 390
	Logic	0: Positive Logic, 1: Negative Logic			
Zero Signal	Device No.	X0 to X17	X□+5*5	X□+2*5	Page 391
	Logic	0: Positive Logic, 1: Negative Logic			
	OPR zero signal counts	0 to 32767			
	Count Start Time	0: Near-point Dog Latter Part, 1: Near-point Dog Front Part			
Axis Common Parameter					
Enabled/Disabled Reset All Modules at Error Stop	—			0: Disabled, 1: Enabled	Page 383

- \*1 Only FX5S/FX5U/FX5UC CPU module and high-speed pulse input/output module can use this item or setting.
- \*2 PULSE/CW is fixed to the output device (Y) of "axis number -1".
- \*3 In the CW/CCW mode, PULSE/CW and SIGN/CCW are fixed to Y0 (CW)/Y2 (CCW), Y1 (CW)/Y3 (CCW).
- \*4 The number in ■ is first module: 5, second module: 7, third module: 9, fourth module: 11.
- \*5 □: Head input/output number for each high-speed pulse input/output module

## Input check

The usage status of the input device (X) can be checked from the input check window.

### Window

#### ■CPU module

 [Navigation window] ⇒ [Parameter] ⇒ Module model name ⇒ [Module Parameter] ⇒ [High Speed I/O] ⇒ [Input Check] ⇒ [Positioning]

Item	X0	X1	X2	X3	X4	X5	X6	X7	X10	X11	X12	X13	X14	X15	X16	X17
<b>Positioning</b>																
Axis 1 External Start Signal Positive Logic	0															
Axis 1 External Start Signal Negative Logic																
Axis 1 Interrupt Input Signal 1 High Speed																
Axis 1 Interrupt Input Signal 1 Standard Positive Logic																
Axis 1 Interrupt Input Signal 1 Standard Negative Logic																
Axis 1 Near-point Dog Signal								0								
Axis 1 Zero Signal Positive Logic					0											
Axis 1 Zero Signal Negative Logic																
Axis 1 Interrupt Input Signal 2																
Axis 2 External Start Signal Positive Logic																
Axis 2 External Start Signal Negative Logic																

#### ■High-speed pulse input/output module

 [Navigation window] ⇒ [Parameter] ⇒ [1 to 16 (high-speed pulse input/output module)] ⇒ [Module Parameter] ⇒ [Input Check] ⇒ [Positioning]

Item	X20	X21	X22	X23	X24	X25	X26	X27
<b>Positioning</b>								
Axis 5 External Start Signal Positive Logic								0
Axis 5 External Start Signal Negative Logic								
Axis 5 Interrupt Input Signal 1 High Speed								
Axis 5 Interrupt Input Signal 1 Standard Positive Logic								
Axis 5 Interrupt Input Signal 1 Standard Negative Logic								
Axis 5 Near-point Dog Signal	0							
Axis 5 Zero Signal Positive Logic					0			
Axis 6 External Start Signal Positive Logic								
Axis 6 External Start Signal Negative Logic								

Shown above is the screen at the time when the first high-speed pulse input/output module is selected.

# Output check

The usage status of the output device (Y) can be checked from the output check window.

## Window

### ■CPU module

[Navigation window] ⇒ [Parameter] ⇒ Module model name ⇒ [Module Parameter] ⇒ [High Speed I/O] ⇒ [Output Confirmation] ⇒ [Positioning]

Item	Y0	Y1	Y2	Y3	Y4	Y5	Y6	Y7	Y10	Y11	Y12	Y13	Y14	Y15	Y16	Y17
<b>Positioning</b>																
Axis 1 Pulse Output (PULSE)																
Axis 1 Pulse Output (SIGN)																
Axis 1 Pulse Output (CW)	0															
Axis 1 Pulse Output (CCW)			0													
Axis 1 Clear Signal									0							
Axis 2 Pulse Output (PULSE)		0														
Axis 2 Pulse Output (SIGN)						0										
Axis 2 Pulse Output (CW)																
Axis 2 Pulse Output (CCW)																
Axis 2 Clear Signal										0						
Axis 3 Pulse Output (PULSE)																
Axis 3 Pulse Output (SIGN)																
Axis 3 Pulse Output (CW)																
Axis 3 Pulse Output (CCW)																
Axis 3 Clear Signal																
Axis 4 Pulse Output (PULSE)				0												
Axis 4 Pulse Output (SIGN)									0							
Axis 4 Pulse Output (CW)																
Axis 4 Pulse Output (CCW)																
Axis 4 Clear Signal																

### ■High-speed pulse input/output module

[Navigation window] ⇒ [Parameter] ⇒ [1 to 16 (high-speed pulse input/output module)] ⇒ [Module Parameter] ⇒ [Output Confirmation] ⇒ [Positioning]

Item	Y20	Y21	Y22	Y23	Y24	Y25	Y26	Y27
<b>Positioning</b>								
Axis 5 Pulse Output (PULSE)								
Axis 5 Pulse Output (SIGN)								
Axis 5 Pulse Output (CW)	0							
Axis 5 Pulse Output (CCW)					0			
Axis 5 Clear Signal			0					
Axis 6 Pulse Output (PULSE)		0						
Axis 6 Pulse Output (SIGN)						0		
Axis 6 Pulse Output (CW)								
Axis 6 Pulse Output (CCW)								
Axis 6 Clear Signal				0				

Shown above is the screen at the time when the first high-speed pulse input/output module is selected.

# 31.2 Details of Parameters

The following describes the details of the parameters and relevant devices.

Note that parameters and relevant devices of axis 4 are available only for the FX5S/FX5U/FX5UC CPU module.

## Common item

The following lists the setting items related to common aspects of positioning operation.

### Pulse Output Mode

▶ Setting method: High Speed I/O Parameter

Specify the pulse output method.

When [0: Not Used] is selected, the positioning function is not used.

When [1: PULSE/SIGN] is selected, the positioning function is executed with the pulse train and direction signal output.

When [2: CW/CCW] is selected, the positioning function is executed with the outputs of the forward pulse train and reverse pulse train.

The following describes the output configuration in the PULSE/SIGN mode and CW/CCW mode.

#### ■ PULSE/SIGN mode

- CPU module

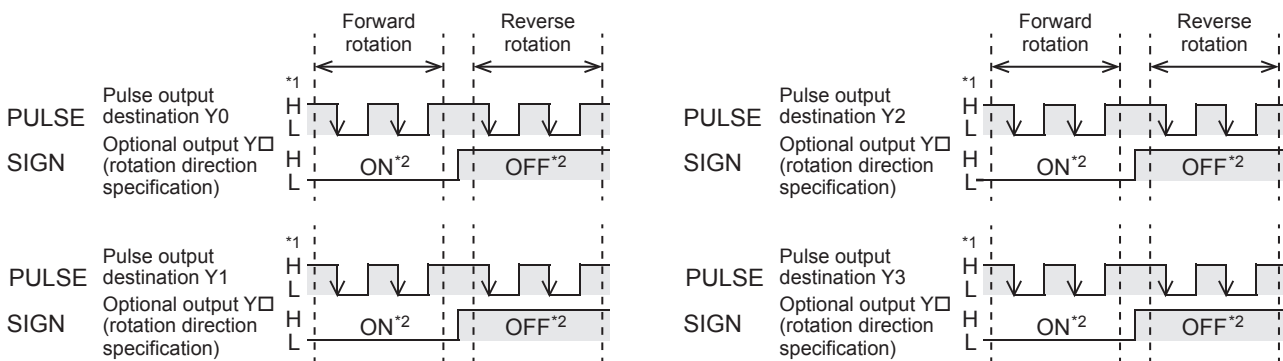

\*1 "H" and "L" respectively represent the HIGH status and the LOW status of the waveform.

\*2 "ON" and "OFF" represent the output status of the FX5 CPU module.

- High-speed pulse input/output module

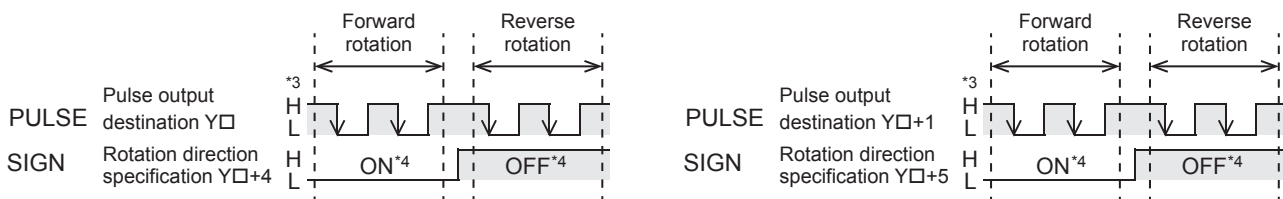

\*3 "H" and "L" respectively represent the HIGH status and the LOW status of the waveform.

\*4 "ON" and "OFF" represent the output status of the high-speed pulse input/output module.

The following table lists the output assignment in the PULSE/SIGN mode.

Item	CPU module				High-speed pulse input/output module*5							
					First module		Second module		Third module		Fourth module	
	Axis 1	Axis 2	Axis 3	Axis 4	Axis 5	Axis 6	Axis 7	Axis 8	Axis 9	Axis 10	Axis 11	Axis 12
PULSE	Y0	Y1	Y2	Y3	Y□	Y□+1	Y□	Y□+1	Y□	Y□+1	Y□	Y□+1
SIGN	Unused device among Y0 to Y17 (Any device can be set.)				Y□+4	Y□+5	Y□+4	Y□+5	Y□+4	Y□+5	Y□+4	Y□+5

\*5 The number in □ is the head output number for each high-speed pulse input/output module.

## ■ CW/CCW mode

- CPU module

Only FX5S/FX5U/FX5UC CPU module support the CW/CCW mode.

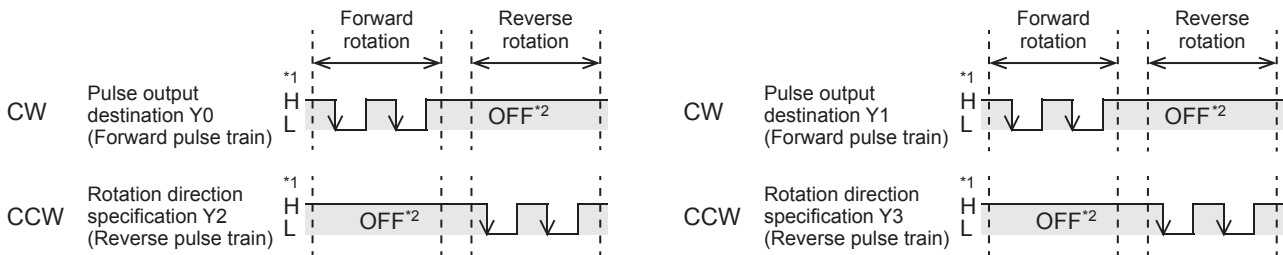

\*1 "H" and "L" respectively represent the HIGH status and the LOW status of the waveform.

\*2 "ON" and "OFF" represent the output status of the CPU module.

- High-speed pulse input/output module

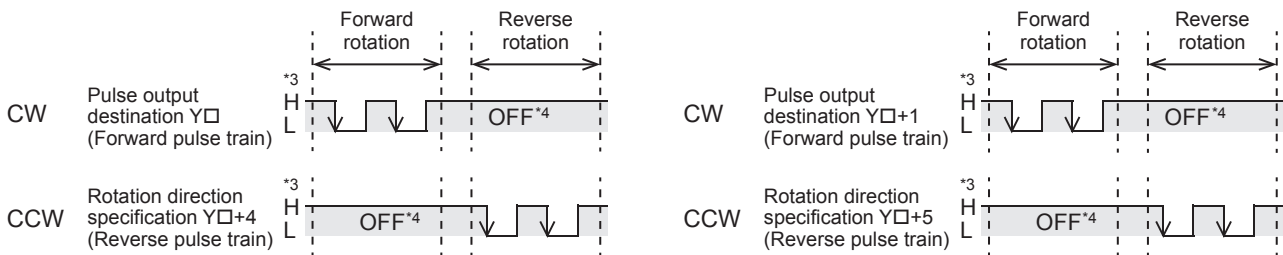

\*3 "H" and "L" respectively represent the HIGH status and the LOW status of the waveform.

\*4 "ON" and "OFF" represent the output status of the high-speed pulse input/output module.

The following table lists the output assignment in the CW/CCW mode. The positioning function can be executed for up to 10 axes.

Item	CPU module				High-speed pulse input/output module*5							
					First module		Second module		Third module		Fourth module	
	Axis 1	Axis 2	Axis 3	Axis 4	Axis 5	Axis 6	Axis 7	Axis 8	Axis 9	Axis 10	Axis 11	Axis 12
CW	Y0	Y1	—		Y□	Y□+1	Y□	Y□+1	Y□	Y□+1	Y□	Y□+1
CCW	Y2	Y3			Y□+4	Y□+5	Y□+4	Y□+5	Y□+4	Y□+5	Y□+4	Y□+5

\*5 The number in □ is the head output number for each high-speed pulse input/output module.

### Point

The PULSE/SIGN mode and CW/CCW mode can be used together. Examples of the combinations are as follows:

- CPU module

When axis 1 is used in CW/CCW mode, PULSE/SIGN mode can be set in axis 2 and 4.

When axis 2 is used in CW/CCW mode, PULSE/SIGN mode can be set in axis 1 and 3.

- High-speed pulse input/output module

The combination of axis 5 in CW/CCW mode and axis 6 in PULSE/SIGN mode, etc. are possible.

## Output Device

▶ Setting method: High Speed I/O Parameter

Set outputs that are used as positioning outputs. Outputs that are not used as positioning outputs can be used as general-purpose output or PWM output.

For PWM output, refer to the following.

☞ Page 319 PWM Function

## ■ PULSE/CW

PULSE output in PULSE/SIGN mode or CW output in CW/CCW mode is selected.

For the CW/CCW mode, this parameter does not need to be set for CW because the axis number and output device (Y) that executes outputs are fixed.

## ■SIGN/CCW

SIGN output in PULSE/SIGN mode or CCW output in CW/CCW mode is selected.

For the CW/CCW mode, this parameter does not need to be set for CCW because the axis number and output device (Y) that executes outputs are fixed.

## Rotation Direction Setting

▶Setting method: High Speed I/O Parameter, Special Device

Set the relationship between motor rotation direction and increase or decrease of the current address.

### ■High Speed I/O Parameter

When [0: Current Address Increment with Forward Run Pulse Output] is selected, the current address increases when forward pulses are output and decreases when reverse pulses are output.

When [1: Current Address Increment with Reverse Run Pulse Output] is selected, the current address increases when reverse pulses are output and decreases when forward pulses are output.

### ■Special Device

Name	CPU module				High-speed pulse input/output module								R/W
	First module		Second module		Third module		Fourth module						
	Axis 1	Axis 2	Axis 3	Axis 4	Axis 5	Axis 6	Axis 7	Axis 8	Axis 9	Axis 10	Axis 11	Axis 12	
Rotation direction setting	SM5772	SM5773	SM5774	SM5775	SM5776	SM5777	SM5778	SM5779	SM5780	SM5781	SM5782	SM5783	R/W

R/W: Read/Write

When rotation direction setting is turned off: The current address increases when forward pulses are output and decreases when reverse pulses are output.

When rotation direction setting is turned on: the current address increases when reverse pulses are output and decreases when forward pulses are output.

### Point

For the PLSV/DPLSV instruction and table operation instruction (control method: [4: Variable Speed Operation] or [5: Table Transition Variable Speed Operation]), the direction of increase/decrease in the address and pulse output direction are determined by the sign of the command speed and rotation direction setting, as shown below.

Item		Rotation Direction Setting	
		Current Value Increment with Forward Run Pulse Output	Current Value Increment with Reverse Run Pulse Output
Command speed	Positive direction	Output direction: Forward Address: Increment	Output direction: Reverse Address: Increment
	0	Output direction: No pulse output, Address: No increase or decrease	
	Negative direction	Output direction: Reverse Address: Decrement	Output direction: Forward Address: Decrement

For the DSZR/DDSZR instruction, the direction of increase/decrease in the address and the pulse output direction are determined by the OPR direction and rotation direction setting. ( Page 418 OPR direction)

## Unit Setting

### ►Setting method: High Speed I/O Parameter

Set the unit system (user unit) to be used for the positioning function.

The selected unit system is applied to the speed used for positioning instructions and operands of positioning-related special devices and positioning instructions (command speed, positioning address) as a unit. The unit types of the positioning control include the motor system unit, machine system unit, and multiple system unit.

Unit system	Item	Position unit	Speed unit	Remarks
Motor System	[0: Motor System (pulse, pps)]	pulse	pps	Based on the number of pulses for position commands and speed commands.
Machine System	[1: Machine System ( $\mu\text{m}$ , cm/min)]	$\mu\text{m}$	cm/min	Based on position commands and $\mu\text{m}$ , $10^{-4}$ inch and mdeg of speed.
	[2: Machine System (0.0001 inch, inch/min)]	$10^{-4}$ inch	inch/min	
	[3: Machine System (mdeg, 10 deg/min)]	mdeg	10 deg/min	
Multiple System	[4: Multiple System ( $\mu\text{m}$ , pps)]	$\mu\text{m}$	pps	Uses the machine system unit for position commands and motor system unit for speed command.
	[5: Multiple System (0.0001 inch, pps)]	$10^{-4}$ inch		
	[6: Multiple System (mdeg, pps)]	mdeg		

The following indicates the relation between the motor system unit and machine system unit.

- Transfer distance (pulse) = Transfer distance ( $\mu\text{m}$ ,  $10^{-4}$  inch, mdeg)  $\times$  No. of pulses per rotation  $\times$  Positioning data magnification  $\div$  Transfer distance per rotation
- Speed command (pps) = Speed command (cm/min, inch/min, 10 deg/min)  $\times$  No. of pulses per rotation  $\times 10^4 \div$  Transfer distance per rotation  $\div 60$

## Precautions

### ■Command error when the machine system unit or multiple system unit is used:

Under the condition of the number of pulses per rotation = A, transfer distance per rotation = B, and relative transfer distance = C, the number of pulses that the CPU module should output is calculated from " $C \times (A/B)$ ". Even if the result of  $(A/B)$  is not an integer, no calculation error occurs as long as the result of  $C \times (A/B)$  is an integer. However, if the result of  $C \times (A/B)$  is not an integer, a rounding error within one pulse occurs.

For positioning operations using absolute address, a rounding error within one pulse may occur. For positioning operations using relative address, errors may accumulate in the current address.

### ■The position unit when the machine system unit or multiple system unit is used:

When the machine system or multiple system is set as the unit system, the number of pulses and transfer distance per rotation must be set. When the machine system or multiple system is set, the position unit is handled as the machine system unit of  $\mu\text{m}$ ,  $10^{-4}$  inch or mdeg. The unit can be selected from  $\mu\text{m}$ ,  $10^{-4}$  inch, and mdeg in the unit setting. However, consider that other positioning address and command speed all have the same unit, and then the same pulse output can be acquired as long as the setting value is the same even with different units. The following is a setting example.

#### Ex.

Setting example of control unit

Condition

Setting item	Setting value	Remarks
Pulse No. of per Rotation	4000 [pulse/REV]	—
Travel distance per rotation	100 [ $\mu\text{m}/\text{REV}$ , $10^{-4}$ inch/REV, mdeg/REV]	—
Position Data Magnification	Single	The transfer distance is handled in $\mu\text{m}$ , $10^{-4}$ inch or mdeg.
Electronic gear of servo amplifier (Setting of servo amplifier)	1/1	—

### ■When set in $\mu\text{m}$

In the positioning operation with transfer distance of 100 [ $\mu\text{m}$ ] and operation speed of 6 [ $\text{cm}/\text{min}$ ], pulses are output as follows.

- Number of pulses to be generated = Transfer distance  $\div$  Transfer distance per rotation  $\times$  Number of pulses per rotation =  $100 [\mu\text{m}] \div 100 [\mu\text{m}/\text{REV}] \times 4000 [\text{pulse}/\text{REV}] = 4000 [\text{pulse}]$
- Pulse frequency = Operation speed<sup>\*1</sup>  $\div$  Transfer distance per rotation<sup>\*1</sup>  $\times$  Number of pulses per rotation =  $6 [\text{cm}/\text{min}] \times 10^4 \div 60 \div 100 [\mu\text{m}/\text{REV}] \times 4000 [\text{pulse}/\text{REV}] = 40000 [\text{pps}]$

\*1 Adjust the units at calculation. 1 cm =  $10^4 \mu\text{m}$ , 1 min = 60 s

### ■When set in $10^{-4}$ inch

In the positioning operation with transfer distance of 100 [ $\times 10^{-4}$  inch] and operation speed of 6 [ $\text{inch}/\text{min}$ ], pulses are output as follows.

- Number of pulses to be generated = Transfer distance  $\div$  Transfer distance per rotation  $\times$  Number of pulses per rotation =  $100 [\times 10^{-4} \text{ inch}] \div 100 [\times 10^{-4} \text{ inch}/\text{REV}] \times 4000 [\text{pulse}/\text{REV}] = 4000 [\text{pulse}]$
- Pulse frequency = Operation speed<sup>\*1</sup>  $\div$  Transfer distance per rotation<sup>\*1</sup>  $\times$  Number of pulses per rotation =  $6 [\text{inch}/\text{min}] \times 10^4 \div 60 \div 100 [\times 10^{-4} \text{ inch}/\text{REV}] \times 4000 [\text{pulse}/\text{REV}] = 40000 [\text{pps}]$

\*1 Adjust the units at calculation. 1 min = 60 s

### ■When set in mdeg

In the positioning operation with transfer distance of 100 [mdeg] and operation speed of 6 [ $\text{deg}/\text{min}$ ], pulses are output as follows.

- Number of pulses to be generated = Transfer distance  $\div$  Transfer distance per rotation  $\times$  Number of pulses per rotation =  $100 [\text{mdeg}] \div 100 [\text{mdeg}/\text{REV}] \times 4000 [\text{pulse}/\text{REV}] = 4000 [\text{pulse}]$
- Pulse frequency = Operation speed<sup>\*1</sup>  $\div$  Transfer distance per rotation<sup>\*1</sup>  $\times$  Number of pulses per rotation =  $6 [10 \text{ deg}/\text{min}] \times 10^4 \div 60 \div 100 [\text{mdeg}/\text{REV}] \times 4000 [\text{pulse}/\text{REV}] = 40000 [\text{pps}]$

\*1 Adjust the units at calculation. 1 deg =  $10^3$  mdeg, 1 min = 60 s

## No. of Pulse per Rotation

▶Setting method: High Speed I/O Parameter

Set the number of pulses required to rotate a motor once, within 1 to 2147483647. This parameter must be set when the unit setting is set to [Machine System] or [Multiple System]. When [Motor System] is set, the setting of this parameter is ignored.

### Precautions

When the servo amplifier has an electronic gear setting, set this parameter considering the multiplication of the electronic gear. The relation between the number of pulses per rotation and electronic gear is as follows.

- Number of pulses per rotation = Encoder resolution (positioning feedback pulse)  $\div$  Electronic gear

For electronic gear, refer to the manual for each servo amplifier.

## Movement Amount per Rotation

▶Setting method: High Speed I/O Parameter

Set the transfer distance of the machine per motor rotation within 1 to 2147483647. This parameter must be set when the unit setting is set to [Machine System] or [Multiple System]. When [Motor System] is set, the setting of this parameter is ignored.



## Position Data Magnification

▶Setting method: High Speed I/O Parameter

The values of positioning addresses can be multiplied by the Position Data Magnification. The available multiplying factors include single, 10 times, 100 times, and 1000 times. The following shows a setting example.

**Ex.**

For magnification by 1000 times

For the positioning address of 123, the following shows the actual address and transfer distance.

- Motor System unit:  $123 \times 10^3 = 123000$  [pulse]
- Machine/Multiple System unit:  $123 \times 10^3 = 123000$  [ $\mu\text{m}$ ,  $10^{-4}$  inch, mdeg] = 123 [mm,  $10^{-1}$  inch, deg]

The following table lists the relation between the positioning data magnification of each unit system.

Position Data Magnification	Unit system setting (position unit)				Unit system setting (speed unit)			
	pulse	$\mu\text{m}$	0.0001 inch	mdeg	pps	cm/min	inch/min	10 deg/min
Single	pulse	$\mu\text{m}$	$\times 0.0001$ inch	mdeg	pps	cm/min	inch/min	$\times 10$ deg/min
10 times	$\times 10$ pulse	$\times 10$ $\mu\text{m}$	$\times 0.001$ inch	$\times 10$ mdeg				
100 times	$\times 100$ pulse	$\times 100$ $\mu\text{m}$	$\times 0.01$ inch	$\times 100$ mdeg				
1000 times	$\times 1000$ pulse	mm	$\times 0.1$ inch	deg				

## Items related to speed

The following describes the setting items related to speed.

### Command speed

▶Setting method: Operand

Set the speed used in positioning operation. The user unit is set by unit setting. (  Page 373 Unit Setting)

The setting range differs depending on the positioning instruction and table operation control method. Set the command speed to 200 kpps<sup>\*1</sup> or lower in pulse ( $-200$  kpps to  $+200$  kpps<sup>\*2</sup> for the PLSV/DPLSV instruction or table operation instruction (control method [4: Variable Speed Operation], [5: Table Transition Variable Speed Operation])).

\*1 100 kpps for the FX5S CPU module

\*2  $-100$  kpps to  $+100$  kpps for the FX5S CPU module

Even within the setting range, the following relation must be followed: bias speed  $\leq$  command speed  $\leq$  maximum speed.

When command speed is faster than the maximum speed, the maximum speed is applied. When positioning instruction start, if bias speed is faster than command speed, the bias speed is applied.

### ■Operand: Positioning Instruction

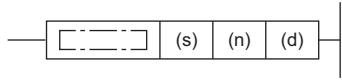
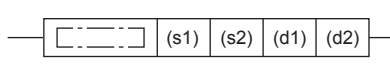
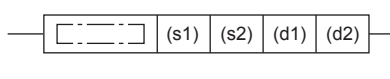
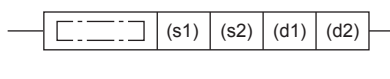
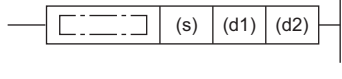
Positioning instruction	Operand	Range	Ladder	Reference	
Pulse Y output <sup>*1*2</sup>	PLSY	(s)	0 to 65535		Page 405
	DPLSY		0 to 2147483647		
Relative positioning	DRVI	(s2)	1 to 65535		Page 421
	DDRVI		1 to 2147483647		
Absolute positioning	DRVA	(s2)	1 to 65535		Page 431
	DDRVA		1 to 2147483647		
Interrupt 1-speed positioning	DVIT	(s2)	1 to 65535		Page 440
	DDVIT		1 to 2147483647		
Variable speed operation <sup>*1</sup>	PLSV	(s)	$-32768$ to $+32767$		Page 450
	DPLSV		$-2147483648$ to $+2147483647$		

\*1 When 0 is set for the command speed at start of a positioning instruction, instruction ends with an error.

\*2 Only CPU module is supported.

## ■Operand: Table Operation Control Method

Table operation control method	Operand	Range	Reference
1: 1 Speed Positioning (Relative Address Specification)	Operand 2 (When the positioning table data is set to use device: Head device +2, +3)	1 to 2147483647	Page 491
2: 1 Speed Positioning (Absolute Address Specification)			Page 493
3: Interrupt 1 Speed Positioning			Page 495
4: Variable Speed Operation <sup>*1</sup>		-2147483648 to +2147483647	Page 498
5: Table Transition Variable Speed Operation <sup>*1*2</sup>			Page 500
6: Interrupt Stop (Relative Address Specification)		1 to 2147483647	Page 502
7: Interrupt Stop (Absolute Address Specification)			Page 505
20: Interpolation Operation (Relative Address Specification) <sup>*3</sup>			Page 509
22: Interpolation Operation (Absolute Address Specification) <sup>*3</sup>			Page 514

\*1 When 0 is set for the command speed at start of a positioning instruction, instruction ends with an error.

\*2 Only CPU module is supported.

\*3 Only FX5S/FX5U/FX5UC CPU module and high-speed pulse input/output module support this operation.

### Point

The command speed can be changed during operation. (☞ Page 360 Command speed change during positioning operation)

## Current speed (user unit)

This indicates the positioning operation speed.

The user unit is set by unit setting. (☞ Page 373 Unit Setting) The range is 0 to 2147483647 (200 kpps<sup>\*1</sup> or lower in pulse).

\*1 100 kpps for the FX5S CPU module

The following table lists the corresponding devices.

Name	CPU module				High-speed pulse input/output module								R/W
					First module		Second module		Third module		Fourth module		
	Axis 1	Axis 2	Axis 3	Axis 4	Axis 5	Axis 6	Axis 7	Axis 8	Axis 9	Axis 10	Axis 11	Axis 12	
Current speed (user unit)	SD5504, SD5505	SD5544, SD5545	SD5584, SD5585	SD5624, SD5625	SD5664, SD5665	SD5704, SD5705	SD5744, SD5745	SD5784, SD5785	SD5824, SD5825	SD5864, SD5865	SD5904, SD5905	SD5944, SD5945	R

R: Read-only

When the unit system is machine system unit, the current speed can be calculated from the equation below.

- Current speed (machine system unit) = Actual output frequency × 60 × Pulse No. of per Rotation ÷ Movement Amount per Rotation ÷ 10<sup>4</sup>

Before being stored in the current speed, the command speed in user unit is converted into pulse unit (pps), and then converted again into user unit. Thus, because of an error due to this calculation process, a value that is lower than the command speed may be stored.

## Precautions

In a program with interruption priority 1, the HCMOV/DHCMOV instruction specified with this device for high-speed pulse input/output module cannot be executed. (☞ Page 109 Interrupt priority)

## Max. Speed

▶Setting method: High Speed I/O Parameter, Special Device

Set the upper limit (maximum speed) for command speed, OPR speed, and creep speed. The user unit is set by unit setting.

(☞ Page 373 Unit Setting)

The setting range is as follows.

Module	Motor/multiple unit system	Machine unit system
FX5S CPU module	1 pps to 100 kpps	1 to 2147483647
FX5UJ CPU module FX5U CPU module FX5UC CPU module High-speed pulse input/output module	1 pps to 200 kpps	1 to 2147483647

Even within the setting range, each of the following relations must be followed: bias speed  $\leq$  creep speed  $\leq$  OPR speed  $\leq$  maximum speed for the DSZR/DDSZR instruction and bias speed  $\leq$  command speed  $\leq$  maximum speed for the other instructions.

## Special Device

Name	CPU module				High-speed pulse input/output module								R/W
					First module		Second module		Third module		Fourth module		
	Axis 1	Axis 2	Axis 3	Axis 4	Axis 5	Axis 6	Axis 7	Axis 8	Axis 9	Axis 10	Axis 11	Axis 12	
Maximum speed	SD5516, SD5517	SD5556, SD5557	SD5596, SD5597	SD5636, SD5637	SD5676, SD5677	SD5716, SD5717	SD5756, SD5757	SD5796, SD5797	SD5836, SD5837	SD5876, SD5877	SD5916, SD5917	SD595, SD5957	R/W

R/W: Read/Write

## Bias Speed

▶Setting method: High Speed I/O Parameter, Special Device

Set the lower limit (bias speed) for command speed, OPR speed, and creep speed. The user unit is set by unit setting.

(☞ Page 373 Unit Setting)

The setting range is as follows.

Module	Motor/multiple unit system	Machine unit system
FX5S CPU module	0 pps to 100 kpps	0 to 2147483647
FX5UJ CPU module FX5U CPU module FX5UC CPU module High-speed pulse input/output module	0 pps to 200 kpps	0 to 2147483647

Even within the setting range, the following relation must be followed: bias speed  $\leq$  command speed (OPR speed)  $\leq$  maximum speed.

To control a stepping motor using each positioning instruction, set the bias speed considering the resonance range and the self-starting frequency of the stepping motor.

## Special Device

Name	CPU module				High-speed pulse input/output module								R/W
					First module		Second module		Third module		Fourth module		
	Axis 1	Axis 2	Axis 3	Axis 4	Axis 5	Axis 6	Axis 7	Axis 8	Axis 9	Axis 10	Axis 11	Axis 12	
Bias speed	SD5518, SD5519	SD5558, SD5559	SD5598, SD5599	SD5638, SD5639	SD5678, SD5679	SD5718, SD5719	SD5758, SD5759	SD5798, SD5799	SD5838, SD5839	SD5878, SD5879	SD5918, SD5919	SD5958, SD5959	R/W

R/W: Read/Write

## Acceleration Time

▶Setting method: High Speed I/O Parameter, Special Device

Set the time required for acceleration from the bias speed to the maximum speed.

The setting range of acceleration time is 0 to 32767 ms. If command speed is slower than the maximum speed, the actual acceleration time becomes shorter than the set time.

### ■Special Device

Name	CPU module				High-speed pulse input/output module								R/W
					First module		Second module		Third module		Fourth module		
	Axis 1	Axis 2	Axis 3	Axis 4	Axis 5	Axis 6	Axis 7	Axis 8	Axis 9	Axis 10	Axis 11	Axis 12	
Acceleration time	SD5520	SD5560	SD5600	SD5640	SD5680	SD5720	SD5760	SD5800	SD5840	SD5880	SD5920	SD5960	R/W

R/W: Read/Write

## Deceleration Time

▶Setting method: High Speed I/O Parameter, Special Device

Set the time required for deceleration from the maximum speed to the bias speed.

The setting range of deceleration time is 0 to 32767 ms. If command speed is slower than the maximum speed, the actual deceleration time becomes shorter than the set time.

### ■Special Device

Name	CPU module				High-speed pulse input/output module								R/W
					First module		Second module		Third module		Fourth module		
	Axis 1	Axis 2	Axis 3	Axis 4	Axis 5	Axis 6	Axis 7	Axis 8	Axis 9	Axis 10	Axis 11	Axis 12	
Deceleration time	SD5521	SD5561	SD5601	SD5641	SD5681	SD5721	SD5761	SD5801	SD5841	SD5881	SD5921	SD5961	R/W

R/W: Read/Write

## Precautions

When deceleration time is set to 0, deceleration is not performed. Because the motor stops immediately, the machine may be damaged.

## Items related to positioning address

The following describes the setting items related to positioning address.

### Positioning address

▶Setting method: Operand

Set the positioning address. The user unit is set by unit setting, and the value indicated does not include positioning data magnification. (Page 373 Unit Setting, Page 375 Position Data Magnification)

The setting range differs depending on the positioning instruction and table operation control method.

Set the positioning address to -2147483648 to +2147483647 in pulse (0 to 2147483647 when PLSY/DPLSY instruction, -2147483648 to +2147483647 when positioning operation by absolute address).

## ■Operand: Positioning Instruction

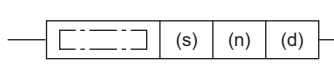
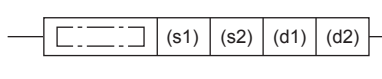
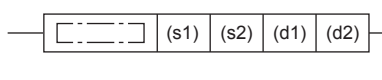
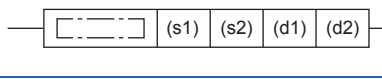
Positioning instruction	Operand	Range	Ladder	Reference	
Pulse Y output*1	PLSY	(n)	0 to 65535		Page 405
	DPLSY		0 to 2147483647*2		
Relative positioning	DRVI	(s1)	-32768 to +32767		Page 421
	DDRVI		-2147483648 to +2147483647*2		
Absolute positioning	DRVA	(s1)	-32768 to +32767		Page 431
	DDRVA		-2147483648 to +2147483647*2		
Interrupt 1-speed positioning	DVIT	(s1)	-32768 to +32767		Page 440
	DDVIT		-2147483648 to +2147483647*2		

\*1 Only CPU module is supported.

\*2 Set the number of output pulses per instruction execution to 2147483647 or lower. (Except for the case when positioning address of DPLSY instruction is 0)

## ■Operand: Table Operation Control Method

Table operation control method	Operand	Range	Reference
1: 1 Speed Positioning (Relative Address Specification)	Operand 1 (When the positioning table data is set to use device: Head device +0, +1)	-2147483648 to +2147483647*2	Page 491
2: 1 Speed Positioning (Absolute Address Specification)			Page 493
3: Interrupt 1 Speed Positioning			Page 495
6: Interrupt Stop (Relative Address Specification)			Page 502
7: Interrupt Stop (Absolute Address Specification)			Page 505
20: Interpolation Operation (Relative Address Specification)*1			Page 509
21: Interpolation Operation (Relative Address Specification Target Axis)*1			Page 513
22: Interpolation Operation (Absolute Address Specification)*1			Page 514
23: Interpolation Operation (Absolute Address Specification Target Axis)*1			Page 518

\*1 Only FX5S/FX5U/FX5UC CPU module and high-speed pulse input/output module support this operation.

\*2 Set the number of output pulses per table to 2147483647 or lower.

### Point

The positioning address can be changed during operation. Only the last table in table operation accepts the change in the case of continuous operation. (☞ Page 359 Positioning address change during positioning operation)

For interpolation operation, the change is applied only when the table operation instruction is next driven again.

## Precautions

Set the number of output pulses per instruction execution or per table to 2147483647 or lower. An error occurs if the number of pulses exceeds 2147483648. However, operation is performed normally if unlimited pulses are being output by PLSY/DPLSY instruction.

## Current address

▶Setting method: Special Device

Store the current address operated by the positioning instruction. The current address stores an absolute address and is increased or decreased depending on the rotation direction.

### ■Current address (user unit)

The user unit is set by unit setting, the value of the following formula (Value not including positioning data magnification) is stored. (☞ Page 373 Unit Setting, Page 375 Position Data Magnification)

- Current address (Motor system) = Movement amount (pulse unit) ÷ Position data magnification
- Current address (Machine/multiple system) = Movement amount (pulse unit) ÷ (No. of pulse per rotation × Position data magnification) × Movement amount per rotation

The address range is -2147483648 to +2147483647.

### ■Special Device

Name	CPU module				High-speed pulse input/output module								R/W
					First module		Second module		Third module		Fourth module		
	Axis 1	Axis 2	Axis 3	Axis 4	Axis 5	Axis 6	Axis 7	Axis 8	Axis 9	Axis 10	Axis 11	Axis 12	
Current address (user unit)	SD5500, SD5501	SD5540, SD5541	SD5580, SD5581	SD5620, SD5621	SD5660, SD5661	SD5700, SD5701	SD5740, SD5741	SD5780, SD5781	SD5820, SD5821	SD5860, SD5861	SD5900, SD5901	SD5940, SD5941	R/W

R/W: Read/Write

When the value in the devices above is changed, the current address (pulse unit) is also changed.

### Point

- Writing can be performed to the current address (user unit) only by the HCMOV/DHCMOV instruction. However, writing to the current address (user unit) during positioning operation is disabled.
- Reading can be performed to the current value by the HCMOV/DHCMOV instruction.
- In a program with interruption priority 1, the HCMOV/DHCMOV instruction specified with this device for high-speed pulse input/output module cannot be executed. (☞ Page 109 Interrupt priority)

## Precautions

The current address (user unit) functions within the range of -2147483648 to +2147483647. However, an overflow or underflow occurs before the current address (pulse unit) is reached if the axis parameter is set in such a way that the number of pulses per rotation is greater than the number of transfer distance units per rotation. If that happens, overflow/underflow to the upper or lower limit value is stored in the device.

### ■Current address (pulse unit)

The unit is the motor system unit (pulse unit), and the value indicated includes positioning data magnification. (☞ Page 373 Unit Setting, Page 375 Position Data Magnification) The address range is -2147483648 to +2147483647.

### ■Special Device

Name	F X *1	CPU module				High-speed pulse input/output module								R/W
						First module		Second module		Third module		Fourth module		
		Axis 1	Axis 2	Axis 3	Axis 4	Axis 5	Axis 6	Axis 7	Axis 8	Axis 9	Axis 10	Axis 11	Axis 12	
Current address (pulse unit)	5	SD5502, SD5503	SD5542, SD5543	SD5582, SD5583	SD5622, SD5623	SD5662, SD5663	SD5702, SD5703	SD5742, SD5743	SD5782, SD5783	SD5822, SD5823	SD5862, SD5863	SD5902, SD5903	SD5942, SD5943	R/W
	3	SD8340, SD8341	SD8350, SD8351	SD8360, SD8361	SD8370, SD8371	—	—	—	—	—	—	—	—	R

R: Read only, R/W: Read or Write

\*1 5: FX5 dedicated device, 3: FX3 compatible device

When the value in the devices above changes, the current address (user unit) also changes automatically.

- Writing can be performed to the current address (pulse unit) of FX5 dedicated device only by the HCMOV/DHCMOV instruction. However, writing to the current address (pulse unit) during positioning operation is disabled.
- Reading can be performed to the current value by the HCMOV/DHCMOV instruction.
- In a program with interruption priority 1, the HCMOV/DHCMOV instruction specified with this device for high-speed pulse input/output module cannot be executed. ( Page 109 Interrupt priority)

## Precautions

The current address (pulse unit) functions with the range of -2147483648 to +2147483647 pulses. However, if the upper limit is exceeded, current address overflows to the lower limit. If below the lower limit, current address underflows to the upper limit.

## Items related to operating command

The following lists the items related to the positioning operation.

For the input interrupt function, refer to the following.

 Page 232 HIGH-SPEED INPUT/OUTPUT FUNCTION

### Interrupt Input Signal 1

▶ Setting method: High Speed I/O Parameter

When the DVIT/DDVIT instruction or table operation instruction (control method: [3: Interrupt 1 Speed Positioning], [6: Interrupt Stop (Relative Address Specification)], [7: Interrupt Stop (Absolute Address Specification)]) is used, set this parameter. If the interrupt input signal 1 is detected, an interrupt is performed.

#### ■ Enabled/Disabled

Specify whether to use the interrupt input signal 1.

When [0: Disabled] is selected, the interrupt input signal 1 cannot be used.

When [1: Enabled] is selected, use interrupt input signal 1.

## Precautions

When interrupt input signal 1 is disabled, the DVIT/DDVIT instruction and table operation (control method: [3: Interrupt 1 Speed Positioning], [6: Interrupt Stop (Relative Address Specification)], [7: Interrupt Stop (Absolute Address Specification)]) do not operate and error occurs.

#### ■ Mode

Specify detection mode of interrupt input signal 1.

When [0: High speed Mode] is selected, the DVIT/DDVIT instruction performs an interrupt when one input is detected. The table operation performs an interrupt when input is detected for the number of interrupt counts. ( Page 393 Interrupt Counts)

When [1: Standard Mode] is selected, an interrupt is performed when one input is detected.

- The high-speed mode is faster than the standard mode in performing the operation from interrupt to pulse output.
- For supported versions for high-speed mode, refer to  Page 966 Added and Enhanced Functions.

## ■Device No.

The interrupt input signal 1 assignment is as follows. For the high-speed pulse input/output module, the input is fixed as shown below, so setting is invalid.

CPU module				High-speed pulse input/output module *1							
				First module		Second module		Third module		Fourth module	
Axis 1	Axis 2	Axis 3	Axis 4	Axis 5	Axis 6	Axis 7	Axis 8	Axis 9	Axis 10	Axis 11	Axis 12
X0 to X17 (Any device can be set.)				X□+4	X□+3	X□+4	X□+3	X□+4	X□+3	X□+4	X□+3

\*1 The number in □ is the head input number for each high-speed pulse input/output module.

Set the input response time (initial values: 10 ms) in input response time parameters. (☞ Page 316 General-purpose Input Functions)

## ■Logic

Specify the logic of interrupt input signal 1. In high-speed mode, it is fixed to positive logic, and the following setting is disabled.

When [0: Positive Logic] is selected, interrupt input signal 1 functions on a rising edge.

When [1: Negative Logic] is selected, interrupt input signal 1 functions on a falling edge.

## Precautions

For details on the following precautions, refer to ☞ Page 526 Functions that share inputs and outputs.

- This is not usable if all inputs are occupied with another high-speed input/output function.
- In the case of standard mode, the input interrupt function is assigned forcibly to the specified input.
- In the case of high-speed mode, one high-speed comparison table is occupied, and this is included in the number of simultaneous execution of the high-speed comparison table and high-speed comparison instruction.

## Pulse output stop command

▶Setting method: Special Device

During the execution of a positioning instruction, if the pulse output stop command is turned on, the pulses being output will immediately stop. The instruction of the pulse output which is stopped ends with error.

## ■Special Device

Name	CPU module				High-speed pulse input/output module								R/W
					First module		Second module		Third module		Fourth module		
	Axis 1	Axis 2	Axis 3	Axis 4	Axis 5	Axis 6	Axis 7	Axis 8	Axis 9	Axis 10	Axis 11	Axis 12	
Pulse output stop command	SM5628	SM5629	SM5630	SM5631	SM5632	SM5633	SM5634	SM5635	SM5636	SM5637	SM5638	SM5639	R/W

R/W: Read/Write

### Point

During positioning operation, a change in the pulse output stop command is applied at the next scan time.

## Precautions

- Use pulse output stop command only if immediate stop is absolutely needed to avoid danger. Because the motor stops immediately, the machine may be damaged.
- For normal stop (deceleration and stop), turn off the positioning instruction and use the pulse decelerate and stop, forward limit, and reverse limit. (☞ Page 383 Pulse decelerate and stop command, Page 384 Forward limit, Page 384 Reverse limit)



## Pulse decelerate and stop command

▶Setting method: Special Device

During the execution of a positioning instruction, if the pulse decelerate and stop command is turned on, the pulses being output will decelerate and stop.

The instruction of the pulse output which is stopped ends with error after decelerate and stop. However, the PLSY/DPLSY instruction (when unlimited pulses are output), the PLSV/DPLSV instruction and table operation instruction (control method: [4: Variable Speed Operation] or [5: Table Transition Variable Speed Operation]) end normally. For remaining distance operation-compatible positioning instructions and table control methods, the remaining distance operation ready status is acquired by turning off the pulse decelerate and stop command when remaining distance operation enabled is on. (  Page 362 Remaining distance operation)

### ■Special Device

Name	CPU module				High-speed pulse input/output module								R/W
					First module		Second module		Third module		Fourth module		
	Axis 1	Axis 2	Axis 3	Axis 4	Axis 5	Axis 6	Axis 7	Axis 8	Axis 9	Axis 10	Axis 11	Axis 12	
Pulse decelerate and stop command	SM5644	SM5645	SM5646	SM5647	SM5648	SM5649	SM5650	SM5651	SM5652	SM5653	SM5654	SM5655	R/W

R/W: Read/Write

#### Point

During positioning operation, a change in the pulse decelerate and stop command is applied at the next scan.

31

### Precautions

When the deceleration time is set to 0, the PLSV/DPLSV instruction or table operation (control method: [4: Variable Speed Operation] or [5: Table Transition Variable Speed Operation]) is immediately stopped after the pulse decelerate and stop command turns on. (  Page 378 Deceleration Time)

## Enabled/Disabled Reset All Modules at Error Stop

▶Setting method: High Speed I/O Parameter

Specify whether to use the all module reset when a stop error occurs (  Page 363 All module reset when a stop error occurs). Only high-speed pulse input/output module is supported.

When [0: Disabled] is selected, all module reset when a stop error occurs cannot be used.

When [1: Enabled] is selected, use all module reset when a stop error occurs.

For supported versions for all module reset when a stop error occurs, refer to  Page 966 Added and Enhanced Functions.

## External Start Signal

▶Setting method: High Speed I/O Parameter

Set this parameter to start positioning at high-speed using an external input signal.

This parameter can be used as a start command of the remaining distance operation or table shift command of stepping operation of the DRVTBL instruction. (  Page 362 Remaining distance operation, Page 519 Stepping operation)

### ■Enabled/Disabled

Specify whether to use the external start signal.

When [0: Disabled] is selected, the external start signal is not used.

When [1: Enabled] is selected, the external start signal is used.

With this parameter enabled, even when the drive contact of each positioning instruction is turned on, the standby status is held. In this status, turning on the set input signal starts positioning.

## ■Device No.

The external start signal assignment is as follows.

CPU module				High-speed pulse input/output module*1							
				First module		Second module		Third module		Fourth module	
Axis 1	Axis 2	Axis 3	Axis 4	Axis 5	Axis 6	Axis 7	Axis 8	Axis 9	Axis 10	Axis 11	Axis 12
X0 to X17 (Any device can be set.)				X□+7	X□+6	X□+7	X□+6	X□+7	X□+6	X□+7	X□+6

\*1 The number in □ is the head input number for each high-speed pulse input/output module.

Set the input response time (initial values: 10 ms) in input response time parameters. (☞ Page 316 General-purpose Input Functions)

## Precautions

This is not usable if all inputs are occupied with another high-speed input/output function. However, overlap of input numbers is allowed for input interrupts. (☞ Page 526 Functions that share inputs and outputs)

## ■Logic

Specify the logic of the external start signal.

When [0: Positive Logic] is selected, the external start signal functions on a rising edge.

When [1: Negative Logic] is selected, the external start signal functions on a falling edge.

## Forward limit

▶Setting method: Special Device

Forward limit notifies the CPU module of the forward limit.

If forward limit is turned on while positioning operation is being output in the forward direction, the speed will decelerate, and the operation will stop (the PLSY/DPLSY instruction will stop immediately). If forward limit is turned on while positioning operation is being output in the reverse direction, it is ignored.

For details on the operation, refer to ☞ Page 359 Forward limit and reverse limit. A specific operation pattern is applied when the DSZR/DDSZR instruction is used. (☞ Page 356 Dog search function) Operation ends with an error after deceleration stop when a positioning instruction other than the DSZR/DDSZR instruction is used.

## ■Special Device

Name	CPU module				High-speed pulse input/output module								R/W
					First module		Second module		Third module		Fourth module		
	Axis 1	Axis 2	Axis 3	Axis 4	Axis 5	Axis 6	Axis 7	Axis 8	Axis 9	Axis 10	Axis 11	Axis 12	
Forward limit	SM5660	SM5661	SM5662	SM5663	SM5664	SM5665	SM5666	SM5667	SM5668	SM5669	SM5670	SM5671	R/W

R/W: Read/Write



During positioning operation, a change in the forward limit is applied at the next scan.

## Reverse limit

▶Setting method: Special Device

Reverse limit notifies the CPU module of the reverse limit.

If reverse limit is turned on while positioning operation is being output in the reverse direction, the speed will decelerate, and the operation will stop. If reverse limit is turned on while positioning operation is being output in the forward direction, it is ignored. However, it is effective for the PLSY/DPLSY instruction that operates in the forward direction. If reverse limit is turned on, the operation will stop immediately.

For details on the operation, refer to ☞ Page 359 Forward limit and reverse limit. A specific operation pattern is applied when the DSZR/DDSZR instruction is used. (☞ Page 356 Dog search function) Operation ends with an error after deceleration stop when a positioning instruction other than the DSZR/DDSZR instruction is used.

## ■Special Device

Name	CPU module				High-speed pulse input/output module								R/W
					First module		Second module		Third module		Fourth module		
	Axis 1	Axis 2	Axis 3	Axis 4	Axis 5	Axis 6	Axis 7	Axis 8	Axis 9	Axis 10	Axis 11	Axis 12	
Reverse limit	SM5676	SM5677	SM5678	SM5679	SM5680	SM5681	SM5682	SM5683	SM5684	SM5685	SM5686	SM5687	R/W

R/W: Read/Write

### Point

During positioning operation, a change in the reverse limit is applied at the next scan.

## Remaining distance operation

▶Setting method: Special Device

For the remaining distance operation, refer to  Page 362 Remaining distance operation.

### ■Remaining distance operation enabled

Remaining distance operation enabled enables remaining distance operation with remaining distance operation-compatible instructions.

If remaining distance operation enabled is on when deceleration stop is performed with the pulse decelerate and stop command, the remaining distance operation ready status is acquired. ( Page 383 Pulse decelerate and stop command)

For positioning instructions or a control method of the table operation that is not compatible with the remaining distance operation, the remaining distance ready status is not acquired even when remaining distance operation enabled is ON.

## ■Special Device

Name	CPU module				High-speed pulse input/output module								R/W
					First module		Second module		Third module		Fourth module		
	Axis 1	Axis 2	Axis 3	Axis 4	Axis 5	Axis 6	Axis 7	Axis 8	Axis 9	Axis 10	Axis 11	Axis 12	
Remaining distance operation enabled	SM5596	SM5597	SM5598	SM5599	SM5600	SM5601	SM5602	SM5603	SM5604	SM5605	SM5606	SM5607	R/W

R/W: Read/Write



### Point

During positioning operation, a change in remaining distance operation enabled is applied at the next scan.

## Precautions

If the remaining distance operation enabled remains off until deceleration stop of the pulse decelerate and stop command, the remaining distance operation-compatible instruction ends with an error.

### ■Remaining distance operation start

In the remaining distance operation ready status, turning on remaining distance operation enabled after turning off the pulse decelerate and stop command starts remaining distance operation. ( Page 383 Pulse decelerate and stop command) In addition, remaining distance operation can be started with the external start signal, as well as the remaining distance operation start. ( Page 383 External Start Signal) Remaining distance operation start turns off when the remaining distance operation starts.

## ■Special Device

Name	CPU module				High-speed pulse input/output module								R/W
					First module		Second module		Third module		Fourth module		
	Axis 1	Axis 2	Axis 3	Axis 4	Axis 5	Axis 6	Axis 7	Axis 8	Axis 9	Axis 10	Axis 11	Axis 12	
Remaining distance operation start	SM5612	SM5613	SM5614	SM5615	SM5616	SM5617	SM5618	SM5619	SM5620	SM5621	SM5622	SM5623	R/W

R/W: Read/Write



During positioning operation, a change in the remaining distance operation start is applied at the next scan.

## Precautions

When the drive contact of a positioning instruction is turned off without remaining distance operation, the remaining distance operation is canceled.

## Items related to pulse Y output instruction

The following lists the items related to the pulse output (PLSY/DPLSY) instruction. Only CPU module is supported.

### Total number of pulses output from axis 1 and axis 2

▶Setting method: Special Device

The total number of the pulses output by PLSY/DPLSY instruction in axis 1 and axis 2. The total number is increased by forward rotation pulses, regardless of the setting of rotation direction, because the PLSY/DPLSY instruction outputs only forward rotation pulses. The pulse range is -2147483648 to +2147483647.

## ■Special Device

Name	For compatibility with FX3				R/W
	Axis 1	Axis 2	Axis 3	Axis 4	
Total number of pulses output from axis 1 and axis 2	SD8136, SD8137		—	—	R/W

R/W: Read/Write

### Number of pulses output by PLSY instruction

▶Setting method: Special Device

The number of pulses output by PLSY/DPLSY instruction. The total number is increased by forward rotation pulses, regardless of the setting of rotation direction, because the PLSY/DPLSY instruction outputs only forward rotation pulses. The pulse range is -2147483648 to +2147483647.

## ■Special Device

Name	For compatibility with FX3				R/W
	Axis 1	Axis 2	Axis 3	Axis 4	
Number of pulses output by PLSY instruction	SD8140, SD8141	SD8142, SD8143	—	—	R/W

R/W: Read/Write

# Items related to OPR

The following lists the items related to the OPR. (☞ Page 349 Mechanical OPR, Page 411 Mechanical OPR)

For the input interrupt function, refer to the following.

☞ Page 232 HIGH-SPEED INPUT/OUTPUT FUNCTION

## OPR Enabled/Disabled

▶Setting method: High Speed I/O Parameter

Specify whether to use the OPR.

When [0: Disabled] is selected, OPR related parameters cannot be set.

When [1: Enabled] is selected, OPR related parameters can be set.

## Precautions

1 high-speed comparison table is occupied for an axis with OPR enabled for the high-speed pulse input/output module.

(☞ Page 254 High-speed comparison table)

## OPR Direction

▶Setting method: High Speed I/O Parameter, Special Device

Specify the direction when OPR is started.

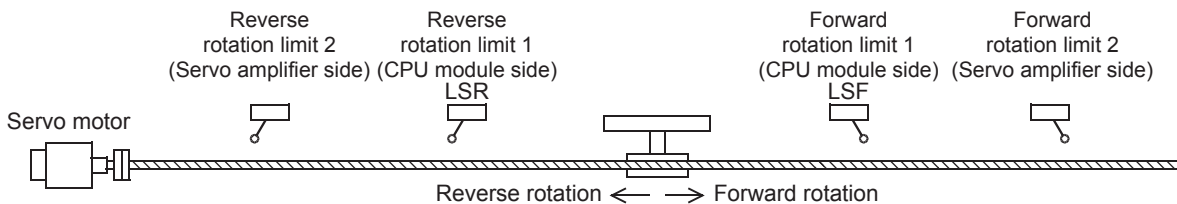

## High Speed I/O Parameter

When [0: Negative Direction (Address Decrement Direction)] is selected, OPR starts in the direction in which address decreases.

When [1: Positive Direction (Address Increment Direction)] is selected, OPR starts in the direction in which address increases.

## Special Device

Name	CPU module				High-speed pulse input/output module								R/W
					First module		Second module		Third module		Fourth module		
	Axis 1	Axis 2	Axis 3	Axis 4	Axis 5	Axis 6	Axis 7	Axis 8	Axis 9	Axis 10	Axis 11	Axis 12	
OPR direction specification	SM5804	SM5805	SM5806	SM5807	SM5808	SM5809	SM5810	SM5811	SM5812	SM5813	SM5814	SM5815	R/W

R/W: Read/Write

OPR direction specification is turned off: OPR starts in the direction in which address decreases.

OPR direction specification is turned on: OPR starts in the direction in which address increases.

## Starting Point Address

▶Setting method: High Speed I/O Parameter, Special Device

Set the origin address for OPR.

The user unit is set by unit setting, and the value indicated does not include positioning data magnification. (Page 373 Unit Setting, Page 375 Position Data Magnification) The origin address range is -2147483648 to +2147483647.

### Special Device

Name	CPU module				High-speed pulse input/output module								R/W
					First module		Second module		Third module		Fourth module		
	Axis 1	Axis 2	Axis 3	Axis 4	Axis 5	Axis 6	Axis 7	Axis 8	Axis 9	Axis 10	Axis 11	Axis 12	
Origin address	SD5530, SD5531	SD5570, SD5571	SD5610, SD5611	SD5650, SD5651	SD5690, SD5691	SD5730, SD5731	SD5770, SD5771	SD5810, SD5811	SD5850, SD5851	SD5890, SD5891	SD5930, SD5931	SD5970, SD5971	R/W

R/W: Read/Write

When OPR is completed, the same value as that in the device above is stored in the current address (user unit) and the current address (pulse unit).

## OPR speed

▶Setting method: Operand, Special Device

Set the speed at OPR of the machine. The user unit is set by unit setting. (Page 373 Unit Setting)

The setting range is as follows.

Module	Motor/multiple unit system	Machine unit system
FX5S CPU module	1 pps to 100 kpps	1 to 2147483647
FX5UJ CPU module FX5U CPU module FX5UC CPU module High-speed pulse input/output module	1 pps to 200 kpps	1 to 2147483647

Even within the setting range, the following relation must be followed: bias speed ≤ creep speed ≤ OPR speed ≤ maximum speed. When OPR speed is faster than the maximum speed, the maximum speed is applied.

### Operand: Positioning Instruction

When the following instruction is FX5 operand specified, instruction can set OPR speed.

Instruction	Operand	Range	Ladder	Reference
Mechanical OPR	DSZR	(s1) 1 to 65535		Page 411
	DDSZR	1 to 2147483647		



The OPR speed can be changed during operation. (Page 360 Command speed change during positioning operation)

### Special Device

Name	CPU module				High-speed pulse input/output module								R/W
					First module		Second module		Third module		Fourth module		
	Axis 1	Axis 2	Axis 3	Axis 4	Axis 5	Axis 6	Axis 7	Axis 8	Axis 9	Axis 10	Axis 11	Axis 12	
OPR speed	SD5526, SD5527	SD5566, SD5567	SD5606, SD5607	SD5646, SD5647	SD5686, SD5687	SD5726, SD5727	SD5766, SD5767	SD5806, SD5807	SD5846, SD5847	SD5886, SD5887	SD5926, SD5927	SD5966, SD5967	R/W

R/W: Read/Write

## Precautions

When OPR speed is set in the FX5 operand of the DSZR/DDSZR instruction (s1), the OPR speed is overwritten at execution of the instruction.

## Creep speed

▶Setting method: Operand, Special Device

Set the creep speed at OPR of the machine. The user unit is set by unit setting. (☞ Page 373 Unit Setting)

The setting range is as follows.

Module	Motor/multiple unit system	Machine unit system
FX5S CPU module	1 pps to 100 kpps	1 to 2147483647
FX5UJ CPU module FX5U CPU module FX5UC CPU module High-speed pulse input/output module	1 pps to 200 kpps	1 to 2147483647

Even within the setting range, the following relation must be followed: bias speed ≤ creep speed ≤ OPR speed ≤ maximum speed. When creep speed is faster than OPR speed, the OPR speed is applied. When bias speed is faster than creep speed, the bias speed is applied.

### ■Operand: Positioning Instruction

When the following instruction is FX5 operand specified, instruction can set creep speed.

Instruction	Operand	Range	Ladder	Reference
Mechanical OPR	DSZR	(s2) 1 to 65535		Page 411
	DDSZR	1 to 2147483647		

### Point

The creep speed can be changed during operation. (☞ Page 360 Command speed change during positioning operation)

31

### ■Special Device

Name	CPU module				High-speed pulse input/output module								R/W
					First module		Second module		Third module		Fourth module		
	Axis 1	Axis 2	Axis 3	Axis 4	Axis 5	Axis 6	Axis 7	Axis 8	Axis 9	Axis 10	Axis 11	Axis 12	
Creep speed	SD5528, SD5529	SD5568, SD5569	SD5608, SD5609	SD5648, SD5649	SD5688, SD5689	SD5728, SD5729	SD5768, SD5769	SD5808, SD5809	SD5848, SD5849	SD5888, SD5889	SD5928, SD5929	SD5968, SD5969	R/W

R/W: Read/Write

### Precautions

When creep speed is set in the FX5 operand of the DSZR/DDSZR instruction (s2), creep speed is overwritten at execution of the instruction.

## Clear Signal Output

Specify the output device (Y) to clear droop pulses of the servo amplifier at completion of OPR.

### ■Disabled/Enabled

▶Setting method: High Speed I/O Parameter, Special Device

Specify whether to use the clear signal output.

### ■High Speed I/O Parameter

When [0: Disabled] is selected, the clear signal output is not used.

When [1: Enabled] is selected, the clear signal output is used.

## ■Special Device

Name	CPU module				High-speed pulse input/output module								R/W
					First module		Second module		Third module		Fourth module		
	Axis 1	Axis 2	Axis 3	Axis 4	Axis 5	Axis 6	Axis 7	Axis 8	Axis 9	Axis 10	Axis 11	Axis 12	
Clear signal output function enable	SM5820	SM5821	SM5822	SM5823	SM5824	SM5825	SM5826	SM5827	SM5828	SM5829	SM5830	SM5831	R/W

R/W: Read/Write

Clear signal output function enable is turned off: The clear signal output is not used.

Clear signal output function enable is turned on: The clear signal output is used.

## ■Device No.

▶Setting method: High Speed I/O Parameter

The external start signal assignment is as follows. For high-speed pulse input/output module, it is fixed to the outputs shown below.

CPU module				High-speed pulse input/output module <sup>*1</sup>							
				First module		Second module		Third module		Fourth module	
Axis 1	Axis 2	Axis 3	Axis 4	Axis 5	Axis 6	Axis 7	Axis 8	Axis 9	Axis 10	Axis 11	Axis 12
Y0 to Y17 (Any device can be set.)				Y□+2	Y□+3	Y□+2	Y□+3	Y□+2	Y□+3	Y□+2	Y□+3

\*1 The number in □ is the head output number for each high-speed pulse input/output module.

When the clear signal output is enabled, the clear signal is output from the specified device "20 ms + 1 scan time" after OPR is completed.

## OPR Dwell Time

▶Setting method: High Speed I/O Parameter, Special Device

Set the time until the completion flag for the DSZR/DDSZR instruction is turned on when OPR is completed. The setting range for the OPR dwell time is 0 to 32767 ms. (Page 358 Dwell time)

## ■Special Device

Name	CPU module				High-speed pulse input/output module								R/W
					First module		Second module		Third module		Fourth module		
	Axis 1	Axis 2	Axis 3	Axis 4	Axis 5	Axis 6	Axis 7	Axis 8	Axis 9	Axis 10	Axis 11	Axis 12	
OPR dwell time	SD5533	SD5573	SD5613	SD5653	SD5693	SD5733	SD5773	SD5813	SD5853	SD5893	SD5933	SD5973	R/W

R/W: Read/Write

## Near-point Dog Signal

Specify the near-point dog signal to be used in OPR.

## ■Device No.

▶Setting method: High Speed I/O Parameter, Operand

The near-point dog signal does not occupy the input interrupt function, and its edge is detected with a 1-ms interrupt.

In CPU module for the same axis, the near-point dog signal can be set in the device to which the zero signal has already been set. In high-speed pulse input/output module, it can be set overlapped to any input device (X) other than the zero signal.

## ■High Speed I/O Parameter

The input devices (X) available for CPU module are X0 to X17. The input devices available for high-speed pulse input/output module are X0 to X377.



### ■Operand: Positioning Instruction

When the FX3 compatible operand is specified, DSZR/DDSZR instruction can set the near-point dog signal. The FX3 compatible operand specification is supported only in CPU module.

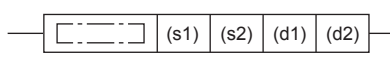
Instruction		Operand	Available device	Ladder	Reference
Mechanical OPR	DSZR	(s1)	X, Y, M, L, SM, F, B, SB		Page 411

### Precautions

- The CPU module cannot be used when the assignment of another high-speed input function occupies 8 channels. However, overlap of input numbers is allowed for input interrupts. (  Page 526 Functions that share inputs and outputs)
- When specifying an input device (X) as an operand, use the device assigned in high speed I/O parameter.

### ■Logic

▶Setting method: High Speed I/O Parameter

Specify the logic of the near-point dog signal.

When [0: Positive Logic] is selected, the near-point dog signal functions on a rising edge.

When [1: Negative Logic] is selected, the near-point dog signal functions on a falling edge.

### Precautions

This logic setting is not applied to the near-point dog signal for devices other than input device (X) specified by the DSZR/DDSZR instruction. The devices other than input device (X) functions on a rising edge.

### Zero Signal

Specify the zero signal to be used in OPR.

### ■Device No.

▶Setting method: High Speed I/O Parameter, Operand

Zero signal is assigned forcibly to a specified input.

To use the near-point dog signal for stop, set the device to which the near-point dog signal is assigned.

### ■High Speed I/O Parameter

The zero signal assignment is as follows. For high-speed pulse input/output module, it is fixed to the inputs shown below.

CPU module				High-speed pulse input/output module *1							
				First module		Second module		Third module		Fourth module	
Axis 1	Axis 2	Axis 3	Axis 4	Axis 5	Axis 6	Axis 7	Axis 8	Axis 9	Axis 10	Axis 11	Axis 12
X0 to X17 (Any device can be set.)				X□+5	X□+2	X□+5	X□+2	X□+5	X□+2	X□+5	X□+2

\*1 The number in □ is the head input number for each high-speed pulse input/output module.

Set the input response time (initial values: 10 ms) in input response time parameters. (  Page 316 General-purpose Input Functions)

### ■Operand: Positioning Instruction

When the FX3 compatible operand is specified, DSZR/DDSZR instruction can set the zero signal. The FX3 compatible operand specification is supported only in CPU module.

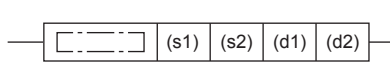
Instruction		Operand	Available device	Ladder	Reference
Mechanical OPR	DSZR	(s2)	X, Y, M, L, SM, F, B, SB		Page 411

## Precautions

For details on the following precautions, refer to  Page 526 Functions that share inputs and outputs.

[CPU module]

- This cannot be used when the assignment of another high-speed input function occupies 8 channels. However, it can overlap with an input interrupt.
- It is not allowed to specify the input device (X) of the high-speed pulse input/output module.
- When specifying an input device (X) as an operand, use the device assigned in high speed I/O parameter.
- When specifying a device other than input devices (X) as an operand, always use the same device as that for the near-point dog signal.

[High-speed pulse input/output module]

- If an input device is used by another high-speed input function, its simultaneous use is not allowed. However, it can overlap with an input interrupt.

### ■Logic

▶Setting method: High Speed I/O Parameter

Specify the logic of the zero signal. For the high-speed pulse input/output module, it is fixed to positive logic.

When [0: Positive Logic] is selected, the zero signal functions on a rising edge.

When [1: Negative Logic] is selected, the zero signal functions on a falling edge.

## Precautions

This logic setting is not applied to the zero signal of the device other than input device (X) specified by the DSZR/DDSZR instruction. The devices other than input device (X) functions on a rising edge.

### ■OPR Zero Signal Counts

▶Setting method: High Speed I/O Parameter, Special Device

Set the number of zero signals until OPR stops after detection of the near-point dog. The timing of counting start of the number of zero signals can be selected using the count start timing between the front end and rear end of the near-point dog. The setting range is from 0 to 32767. When the near-point dog signal and zero signal are set in the same device, the number of zero signals is fixed to 1.

### ■Special Device

Name	CPU module				High-speed pulse input/output module								R/W
					First module		Second module		Third module		Fourth module		
	Axis 1	Axis 2	Axis 3	Axis 4	Axis 5	Axis 6	Axis 7	Axis 8	Axis 9	Axis 10	Axis 11	Axis 12	
OPR zero signal counts	SD5532	SD5572	SD5612	SD5652	SD5692	SD5732	SD5772	SD5812	SD5852	SD5892	SD5932	SD5972	R/W

R/W: Read/Write

## Precautions

When the OPR zero signal counts is set to 0, the motor stops immediately after the near-point dog is detected. If a sudden stop may damage the devices, take the following measures.

- Set the creep speed to a low speed.
- Set the timing of counting start of the number of zero signals to the rear end of the near-point dog.
- Design the near-point dog so that the speed can be decelerated to the creep speed before counting the number of zero signals is started.

### ■Count Start Time

▶Setting method: High Speed I/O Parameter, Special Device

Specify the timing of counting start of the number of zero signals.

### ■High Speed I/O Parameter

When [0: Near-point Dog Latter Part] is selected, start counting at the falling edge of the near-point dog.

When [1: Near-point Dog Front Part] is selected, start counting at the rising edge of the near-point dog.

## Special Device

Name	CPU module				High-speed pulse input/output module								R/W
					First module		Second module		Third module		Fourth module		
	Axis 1	Axis 2	Axis 3	Axis 4	Axis 5	Axis 6	Axis 7	Axis 8	Axis 9	Axis 10	Axis 11	Axis 12	
Zero signal count start time	SM5868	SM5869	SM5870	SM5871	SM5872	SM5873	SM5874	SM5875	SM5876	SM5877	SM5878	SM5879	R/W

R/W: Read/Write

Zero signal count start timing is turned off: Start counting at the falling edge of the near-point dog.

Zero signal count start timing is turned on: Start at the rising edge of the near-point dog.

## Items related to table operation

The following lists the items specific to table operation.

### Dwell Time

▶Setting method: Operand

Set the time until the completion flag is turned on when table operation is completed. (📖 Page 358 Dwell time)

### Operand: Table Operation Control Method

Table operation control method	Operand	Range	Reference
1: 1 Speed Positioning (Relative Address Specification)	Operand 3 (When the positioning table data is set to use device: Head device +4)	0 to 32767 ms	Page 491
2: 1 Speed Positioning (Absolute Address Specification)			Page 493
3: Interrupt 1 Speed Positioning			Page 495
4: Variable Speed Operation			Page 498
5: Table Transition Variable Speed Operation*1			Page 500
6: Interrupt Stop (Relative Address Specification)			Page 502
7: Interrupt Stop (Absolute Address Specification)			Page 505
20: Interpolation Operation (Relative Address Specification)*2			Page 509
22: Interpolation Operation (Absolute Address Specification)*2			Page 514

\*1 Only CPU module is supported.

\*2 Only FX5S/FX5U/FX5UC CPU module and high-speed pulse input/output module support this operation.



When the positioning table data is set to use device, dwell time can be changed during positioning operation. The change is applied when the table operation instruction is next driven again.

### Interrupt Counts

▶Setting method: Operand

Specify the number of inputs necessary for executing an interrupt of the table operation control method [3: Interrupt 1 Speed Positioning], [6: Interrupt Stop (Relative Address Specification)], [7: Interrupt Stop (Absolute Address Specification)] in the case where interrupt input signal 1 is in high-speed mode. (📖 Page 381 Mode)

No interrupt is made unless the input is detected for the number of times specified. If interrupt input signal 1 is in standard mode, the setting is disabled.

### Operand: Table Operation Control Method

Table operation control method	Operand	Range	Reference
3: Interrupt 1 Speed Positioning	Operand 4 (When the positioning table data is set to use device: Head device +5)	1 to 32767	Page 495
6: Interrupt Stop (Relative Address Specification)			Page 502
7: Interrupt Stop (Absolute Address Specification)			Page 505

## Interrupt Input Signal 2 Device No.

▶Setting method: Operand

Set an interrupt input device (X) for shifting to the next table after table operation control method [5: Table Transition Variable Speed Operation]. Only CPU module is supported.

### ■Operand: Table Operation Control Method

Table operation control method	Operand	Range	Reference
5: Table Transition Variable Speed Operation	Operand 4 (When the positioning table data is set to use device: Head device +5)	■FX5S/FX5U/FX5UC CPU module X0 to X17 ■FX5UJ CPU module FX5UJ-24MT/□ • X0 to X15 FX5UJ-40MT/□, FX5UJ-60MT/□ • X0 to X17	Page 500

#### Point

When the positioning table data is set to use device, interrupt input signal 2 device No. can be changed during positioning operation. Changes are applied when the table operation instruction is next driven again.

## Interrupt Input Signal 2 Logic

▶Setting method: High Speed I/O Parameter

Specify the logic of interrupt input signal 2 of the table operation instruction control method [5: Table Transition Variable Speed Operation]. Only CPU module is supported.

When [0: Positive Logic] is selected, interrupt input signal 2 functions on a rising edge.

When [1: Negative Logic] is selected, interrupt input signal 2 functions on a falling edge.

The interrupt input signal 2 does not occupy an input interrupt function, and its edge is detected with a 1-ms interrupt.

## Jump Destination Table No.

▶Setting method: Operand

Set the table number of the jump destination when the jump condition of the table operation control method [10: Condition Jump] is met (M No. for jump condition is on).

### ■Operand: Table Operation Control Method

Table operation control method	Operand	Range	Reference
10: Condition Jump	Operand 3 (When the positioning table data is set to use device: Head device +4)	0 to 100 <sup>*1</sup>	Page 507

\*1 1 to 32, when the positioning table data is not to use the device.

#### Point

When the positioning table data is set to use device, jump destination table No. can be changed during positioning operation. If the table being executed is located three or more tables before the condition jump, the change is applied at the next scan. If the table is located two or fewer tables before (after the condition is determined), the change is applied, but the condition jump is executed using the settings from when the condition was determined.

## M No. for Jump Condition

▶Setting method: Operand

Set an internal relay (M) to be used as a jump condition of the table operation control method [10: Condition Jump]. When M No. for jump condition is on, the condition jump is executed.

## ■Operand: Table Operation Control Method

Table operation control method	Operand	Range	Reference
10: Condition Jump	Operand 4 (When the positioning table data is set to use device: Head device +5)	0 to 32767	Page 507

### Point

When the positioning table data is set to use device, M No. for jump condition can be changed during positioning operation. If the table being executed is located three or more tables before the condition jump, the change is applied at the next scan. If the table is located two or fewer tables before (after the condition is determined), the change is applied, but the condition jump is executed using the settings from when the condition was determined.

## Axis to be Interpolated

### ▶Setting method: Operand

Set the number of the counterpart axis for the simple interpolation operation of table operation control method [20: Interpolation Operation (Relative Address Specification)] or [22: Interpolation Operation (Absolute Address Specification)]. For the counterpart axis, control method [21: Interpolation Operation (Relative Address Specification Target Axis)] or [23: Interpolation Operation (Absolute Address Specification Target Axis)] is assigned to the same table number as that specified in the axis to be interpolated. If a different control method is set to the counterpart axis, it is overwritten with Interpolation operation. Only FX5S/FX5U/FX5UC CPU module and high-speed pulse input/output module support interpolation operation.

## ■Operand: Table Operation Control Method

Table operation control method	Operand	Range	Reference
20: Interpolation Operation (Relative Address Specification)	Operand 4 (When the positioning table data is set to use device: Head device +5)	Axis 1 Specification to Axis 4 Specification	Page 509
22: Interpolation Operation (Absolute Address Specification)			Page 514

## Interpolation Speed Specified Method

### ▶Setting method: High Speed I/O Parameter

Specify the speed specification method for interpolation operation in the table operation. Only FX5S/FX5U/FX5UC CPU module and high-speed pulse input/output module support interpolation operation.

When [0: Composite Speed] is selected, specify the moving speed of the control target and then the CPU module calculates the speed of each axis.

When [1: Reference Axis Speed] is selected, specify the speed of the reference axis and then the CPU module calculates the speed of the other axis.

When the combined speed is specified

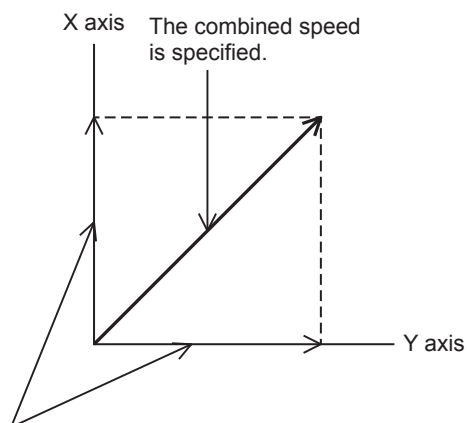

The CPU module calculates these speeds.

When the reference-axis speed is specified

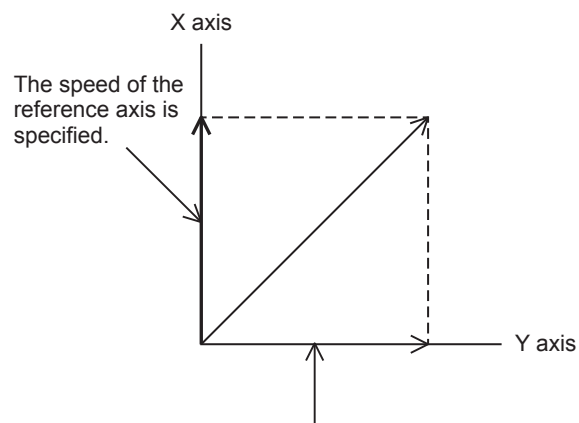

The CPU module calculates these speeds.

## Current speed (composite speed)

This indicates the positioning operation speed (composite speed) for the interpolation operation. When the interpolation speed specified method is [0: Composite Speed], the current speed is stored in the corresponding special device of the reference-axis.

The user unit is set by unit setting. (  Page 373 Unit Setting)

### Special Device

Name	High-speed pulse input/output module								R/W
	First module		Second module		Third module		Fourth module		
	Axis 5	Axis 6	Axis 7	Axis 8	Axis 9	Axis 10	Axis 11	Axis 12	
Current speed (composite speed)	SD5668, SD5669	SD5708, SD5709	SD5748, SD5749	SD5788, SD5789	SD5828, SD5829	SD5868, SD5869	SD5908, SD5909	SD5948, SD5949	R

R: Read-only



## Precautions

In a program with interruption priority 1, the HCMOV/DHCMOV instruction specified with this device for high-speed pulse input/output module cannot be executed. (  Page 109 Interrupt priority)

## Table shift command

▶Setting method: Special Device

Table shift command is to switch to the following table in stepping operation of the DRVTBL instruction.

When stepping operation for a table is completed, if table shift command is OFF→ON, the positioning operation for the following table is started. (  Page 519 Stepping operation) When the positioning operation is still being executed for the previous table or it is not stepping operation of the DRVTBL instruction, OFF→ON this flag is ignored. The table can be switched to the following table with the external start signal too, like the table shift command. (  Page 383 External Start Signal)

### Special Device

Name	CPU module				High-speed pulse input/output module								R/W
	First module		Second module		Third module		Fourth module						
	Axis 1	Axis 2	Axis 3	Axis 4	Axis 5	Axis 6	Axis 7	Axis 8	Axis 9	Axis 10	Axis 11	Axis 12	
Table shift command	SM5580	SM5581	SM5582	SM5583	SM5584	SM5585	SM5586	SM5587	SM5588	SM5589	SM5590	SM5591	R/W

R/W: Read/Write

### Point

During positioning operation, a change in the table shift command is applied at the next scan.

## Positioning execution table number

Use the positioning execution table number to check the table number being executed during table operation.

During activation of a table operation instruction, the table number that was executed last is held. During interpolation operation or multiple axes simultaneous activation, the table number is stored in the positioning execution table number of all the corresponding axes. After the table is executed, the table number is set to 0 when the drive contact of the table instruction is turned off. If there are pulses being output after the drive contact is turned off, the table number is set to 0 after the pulse output stops.

## ■Special Device

Name	CPU module				High-speed pulse input/output module								R/W
					First module		Second module		Third module		Fourth module		
	Axis 1	Axis 2	Axis 3	Axis 4	Axis 5	Axis 6	Axis 7	Axis 8	Axis 9	Axis 10	Axis 11	Axis 12	
Positioning execution table number	SD5506	SD5546	SD5586	SD5626	SD5666	SD5706	SD5746	SD5786	SD5826	SD5866	SD5906	SD5946	R

R: Read-only

## Positioning error (error occurrence table No.)

▶Setting method: Special Device

Use the positioning error to check the table number where a table operation error occurred.

For the error, refer to Page 850 Error check.

## ■Special Device

Name	CPU module				High-speed pulse input/output module								R/W
					First module		Second module		Third module		Fourth module		
	Axis 1	Axis 2	Axis 3	Axis 4	Axis 5	Axis 6	Axis 7	Axis 8	Axis 9	Axis 10	Axis 11	Axis 12	
Positioning error (error occurrence table No.)	SD5511	SD5551	SD5591	SD5631	SD5671	SD5711	SD5751	SD5791	SD5831	SD5871	SD5911	SD5951	R/W

R/W: Read/Write

After the positioning error occurrence flag turns on, a table No. is stored in the device above. If multiple errors occur, the device is overwritten with the table number where the last error occurred.

## Precautions

The table No. of the positioning error (error occurrence table No.) is not cleared by eliminating the error cause.

Turn on SM50 (Error Detection Reset Completion) from program or engineering tool, or use the continuation error batch clear function in the module diagnosis window of GX Works3 to clear the flag. ( GX Works3 Operating Manual)

## Positioning table data initialization disable

▶Setting method: Special Device

Specify whether to use the positioning table data retaining function. ( Page 490 Positioning table data retaining function)

## ■Special Device

Name	CPU module				High-speed pulse input/output module								R/W
					First module		Second module		Third module		Fourth module		
	Axis 1	Axis 2	Axis 3	Axis 4	Axis 5	Axis 6	Axis 7	Axis 8	Axis 9	Axis 10	Axis 11	Axis 12	
Positioning table data initialization disable	SM5916	SM5917	SM5918	SM5919	SM5920	SM5921	SM5922	SM5923	SM5924	SM5925	SM5926	SM5927	R/W

R/W: Read/Write

For versions which support the positioning table data retaining function, refer to Page 966 Added and Enhanced Functions.

### Point

When the positioning table data is set to use latch device and "Use an Initialization Invalid SM" is selected in GX Works3, turn on this device to use the positioning table data retaining function.

## Items related to monitor

The following describes the items related to monitor, such as the positioning address and speed.

### Pulse output monitor

Use the pulse output monitor to check whether pulses are being output from the output device (Y) set as an output device. The pulse output monitor shows the pulse output status even when positioning operation is stopped.

#### Special Device

Name	F X *1	CPU module				High-speed pulse input/output module								R/W
						First module		Second module		Third module		Fourth module		
		Axis 1	Axis 2	Axis 3	Axis 4	Axis 5	Axis 6	Axis 7	Axis 8	Axis 9	Axis 10	Axis 11	Axis 12	
Positioning output monitor	5	SM5516	SM5517	SM5518	SM5519	SM5520	SM5521	SM5522	SM5523	SM5524	SM5525	SM5526	SM5527	R
	3	SM8340	SM8350	SM8360	SM8370	—	—	—	—	—	—	—	—	

R: Read-only

\*1 5: FX5 dedicated device, 3: FX3 compatible device

### Precautions

- When the pulse output monitor is on, do not execute another positioning instruction that uses the corresponding axis.
- Do not write to the pulse output monitor using a transfer instruction. This may change the value and cause abnormal monitoring.

### Positioning instruction activation

Use "positioning instruction activation" to check whether or not a positioning instruction is being executed.

Even if no pulse is output, this flag is on while the instruction is being driven. Even after the drive contact of the positioning instruction is turned off, this flag remains on until the pulse output is stopped. Use this flag to prevent simultaneous activation of two or more positioning instructions for the same axis.

#### Special Device

Name	F X *1	CPU module				High-speed pulse input/output module								R/W
						First module		Second module		Third module		Fourth module		
		Axis 1	Axis 2	Axis 3	Axis 4	Axis 5	Axis 6	Axis 7	Axis 8	Axis 9	Axis 10	Axis 11	Axis 12	
Positioning instruction activation	5	SM5500	SM5501	SM5502	SM5503	SM5504	SM5505	SM5506	SM5507	SM5508	SM5509	SM5510	SM5511	R
	3	SM8348	SM8358	SM8368	SM8378	—	—	—	—	—	—	—	—	

R: Read-only

\*1 5: FX5 dedicated device, 3: FX3 compatible device

### Precautions

Do not write to the pulse output monitor using a transfer instruction. This may change the value and cause abnormal monitoring.

### Positioning error occurrence

►Setting method: Special Device

Use the positioning error occurrence to check whether or not an error specific to the positioning instruction occurs.

This flag turns on when an error specific to the positioning instruction occurs.



## ■Special Device

Name	CPU module				High-speed pulse input/output module								R/W
					First module		Second module		Third module		Fourth module		
	Axis 1	Axis 2	Axis 3	Axis 4	Axis 5	Axis 6	Axis 7	Axis 8	Axis 9	Axis 10	Axis 11	Axis 12	
Positioning error occurrence	SM5532	SM5533	SM5534	SM5535	SM5536	SM5537	SM5538	SM5539	SM5540	SM5541	SM5542	SM5543	R/W

R/W: Read/Write

After the positioning error occurrence is turned on, an error code is stored in the corresponding positioning error (error code).

### Precautions

The positioning error occurrence flag is not cleared by eliminating the error cause.

Turn on SM50 (Error Detection Reset Completion) from program or engineering tool, or use the continuation error batch clear function in the module diagnosis window of GX Works3 to clear the flag. (GX Works3 Operating Manual)

## Positioning error (error code)

▶Setting method: Special Device

Use the following devices to check the error code of an error that has occurred in the positioning operation.

For the error codes, refer to  Page 850 Error check.

## ■Special Device

Name	CPU module				High-speed pulse input/output module								R/W
					First module		Second module		Third module		Fourth module		
	Axis 1	Axis 2	Axis 3	Axis 4	Axis 5	Axis 6	Axis 7	Axis 8	Axis 9	Axis 10	Axis 11	Axis 12	
Positioning error (error code)	SD5510	SD5550	SD5590	SD5630	SD5670	SD5710	SD5750	SD5790	SD5830	SD5870	SD5910	SD5950	R/W

R/W: Read/Write

After the positioning error occurrence flag turns on, an error code is stored in the device above. If multiple errors occur, the old error is overwritten by a new error.

### Precautions

The error code in the positioning error (error code) is not cleared by eliminating the error cause.

Turn on SM50 (Error Detection Reset Completion) from program or engineering tool, or use the continuation error batch clear function in the module diagnosis window of GX Works3 to clear the flag. (GX Works3 Operating Manual)

## Complete flag

### ▶Setting method: Operand

Use the complete flag to check whether or not a positioning instruction is completed. Note that the operation differs depending on the positioning instruction or the control method of the table operation. For details, refer to the complete flag of each positioning instruction and table operation control method.

### ■Instruction execution complete flag

When the positioning operation is completed normally, the instruction execution complete flag turns on. There are the following two types of instruction execution complete flags.

- User specification: The device of the operand specified by the positioning instruction (when FX5 operand specified)

This instruction execution complete flag is used only for the positioning instruction specified. The user-specified instruction execution flag is turned off by program or engineering tool or when the next positioning instruction is activated.

- SM8029: Instruction execution complete flag

This instruction execution complete flag is shared among positioning instructions other than the DRVMUL instruction. In programs, use the flag immediately after a positioning instruction. When the FX3 compatible operand is specified for the positioning instruction, only the instruction execution flag (SM8029) turns on. SM8029 turns off when the drive contact of the positioning instruction is turned off.

The instruction execution complete flags above turn on when pulses have been output. When dwell time is set for the DSZR/ DDSZR instruction or table operation, the flag turns on when pulse output is complete or the clear signal turns off and the dwell time elapses.

### ■Operand: Positioning Instruction

When the following instruction is FX5 operand specified, instruction can set the complete flag.

Instruction	Operand	Available device	Ladder	Reference
Mechanical OPR	DSZR	(d2)		Page 411
	DDSZR			
Relative positioning	DRVI	(d2)		Page 421
	DDRVI			
Absolute positioning	DRVA	(d2)		Page 431
	DDRVA			
Interrupt 1-speed positioning	DVIT	(d2)		Page 440
	DDVIT			
Variable speed operation	PLSV	(d2)		Page 450
	DPLSV			
Multiple-table operation	DRVTLB	(d2)		Page 468
Multiple-axis table operation	DRVMUL	(d)		Page 476

## ■Special Device

Name	CPU module				High-speed pulse input/output module								R/W
					First module		Second module		Third module		Fourth module		
	Axis 1	Axis 2	Axis 3	Axis 4	Axis 5	Axis 6	Axis 7	Axis 8	Axis 9	Axis 10	Axis 11	Axis 12	
Instruction execution complete flag	SM8029 (FX3 compatible device)											R	

R: Read-only

## ■Instruction execution abnormal end flag

When the positioning operation is completed abnormally, the instruction execution abnormal end flag turns on. There are the following two types of instruction execution abnormal end flags.

- User specification: The device of the operand specified by the positioning instruction (when FX5 operand specified)

This instruction execution abnormal end flag is used only for the positioning instruction specified. The user-specified instruction execution abnormal end flag is turned off by program or engineering tool or when the next positioning instruction is activated.

- SM8329: Instruction execution abnormal end flag

This instruction execution abnormal end complete flag is shared among positioning instructions other than the DRVMUL instruction. In programs, use the flag immediately after a positioning instruction. When the FX3 compatible operand is specified for the positioning instruction, only the instruction execution abnormal end flag (SM8329) turns on. SM8329 turns off when the drive contact of the positioning instruction is turned off.

For the conditions under which the instruction execution abnormal end flags above turn on, refer to the operation of the complete flag of each positioning instruction and the table operation control method. When dwell time is set for the DSZR/ DDSZR instruction or table operation, the flag turns on when pulse output is complete and the dwell time elapses.

## ■Operand

Refer to instruction execution complete flag. The device of the operand specified by the positioning instruction is (d2) +1 ((d)+1 when DRVMUL instruction).

## ■Special Device

Name	CPU module				High-speed pulse input/output module								R/W
					First module		Second module		Third module		Fourth module		
	Axis 1	Axis 2	Axis 3	Axis 4	Axis 5	Axis 6	Axis 7	Axis 8	Axis 9	Axis 10	Axis 11	Axis 12	
Instruction execution abnormal end flag	SM8329 (FX3 compatible device)											R	

R: Read-only

# 32 POSITIONING INSTRUCTION

This chapter describes positioning instructions that are used in the positioning function.

For the expression and execution type of the applied instruction, refer to MELSEC iQ-F FX5 Programming Manual (Instructions, Standard Functions/Function Blocks).

## 32.1 Common Items

This section describes the common items in the positioning instruction. For auxiliary functions, refer to Page 356 Auxiliary Function.

### Operand specification method

The operand specification method includes two types: FX5 operand and FX3 compatible operand. The operand setting differs depending on the specification method. The items that cannot be set through operands positioning instruction follow the setting values of the positioning parameters. ( Page 364 POSITIONING PARAMETER)

The FX3 compatible operand is supported only in CPU module.

The DDSZR, DRVTBL, DRVMUL, and DABS instructions have only one operand specification method.

### Start speed

The start speed of instructions for specifying positioning addresses and table operation control methods, except for the PLSY/DPLSY instruction, PLSV/DPLSV instruction, and table operation instruction (control method: [4: Variable Speed Operation] or [5: Table Transition Variable Speed Operation]), is calculated by the following equation:

- Start speed = (Maximum speed - Bias speed) ÷ Acceleration time

The start speed varies as follows, depending on the command speed and bias speed:

(1) Bias speed < Start speed < Command speed: Start speed = Start speed (the value from the equation above)

In the case of Bias speed (5 pps) < Start speed (Approx. 13.6 pps) < Command speed (45 pps)

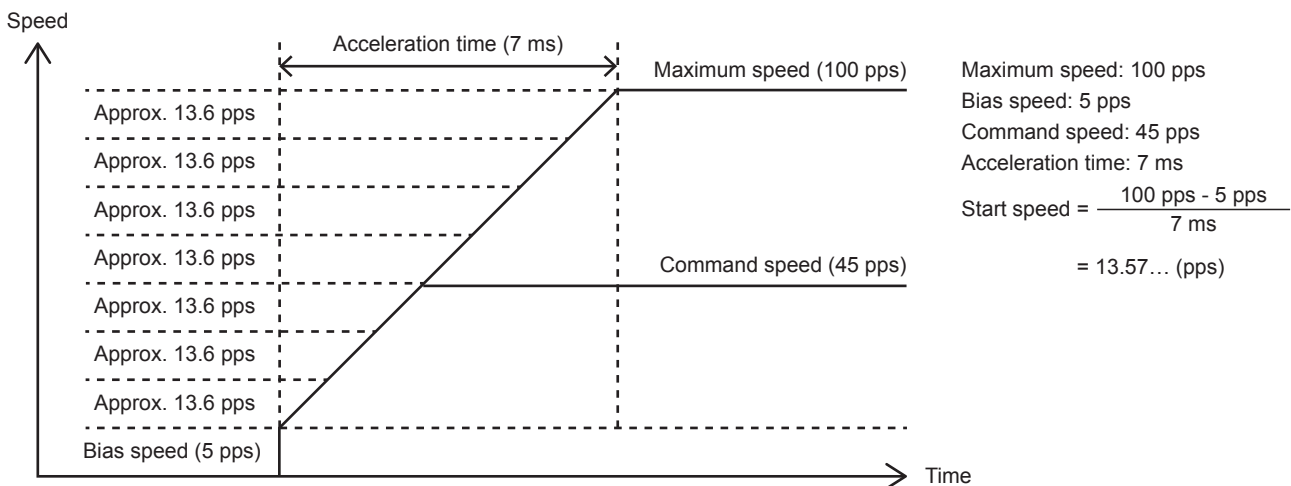

(2) Bias speed < Command speed < Start speed: Start speed = Command speed

In the case of Bias speed (5 pps) < Command speed (10 pps) < Start speed (Approx. 13.6 pps)

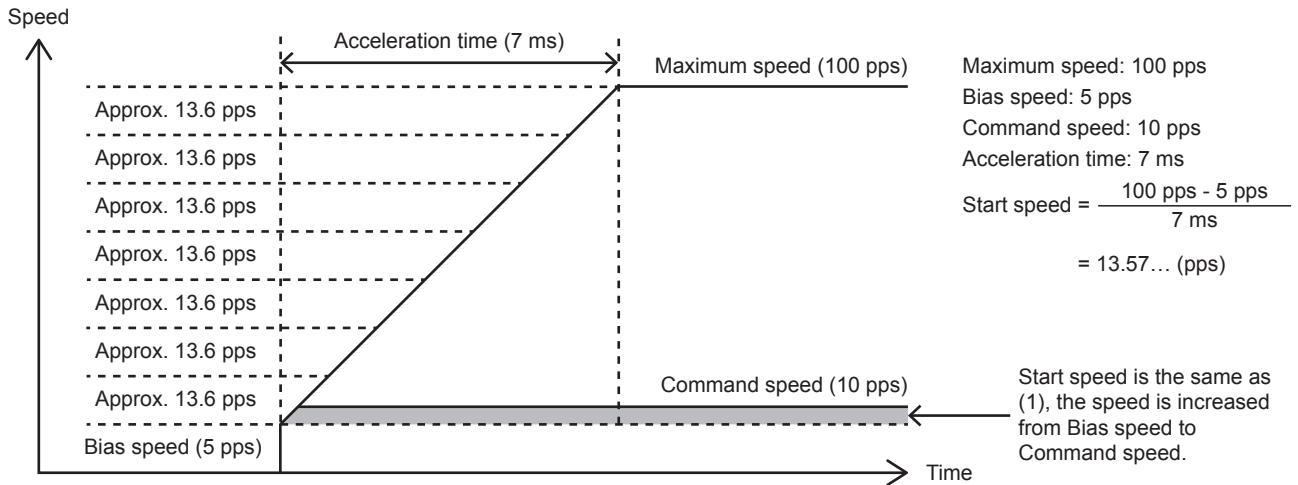

(3) Start speed < Bias speed, or Command speed < Bias speed: Start speed = Bias speed

In the case of Command speed (10 pps) < Bias speed (20 pps)

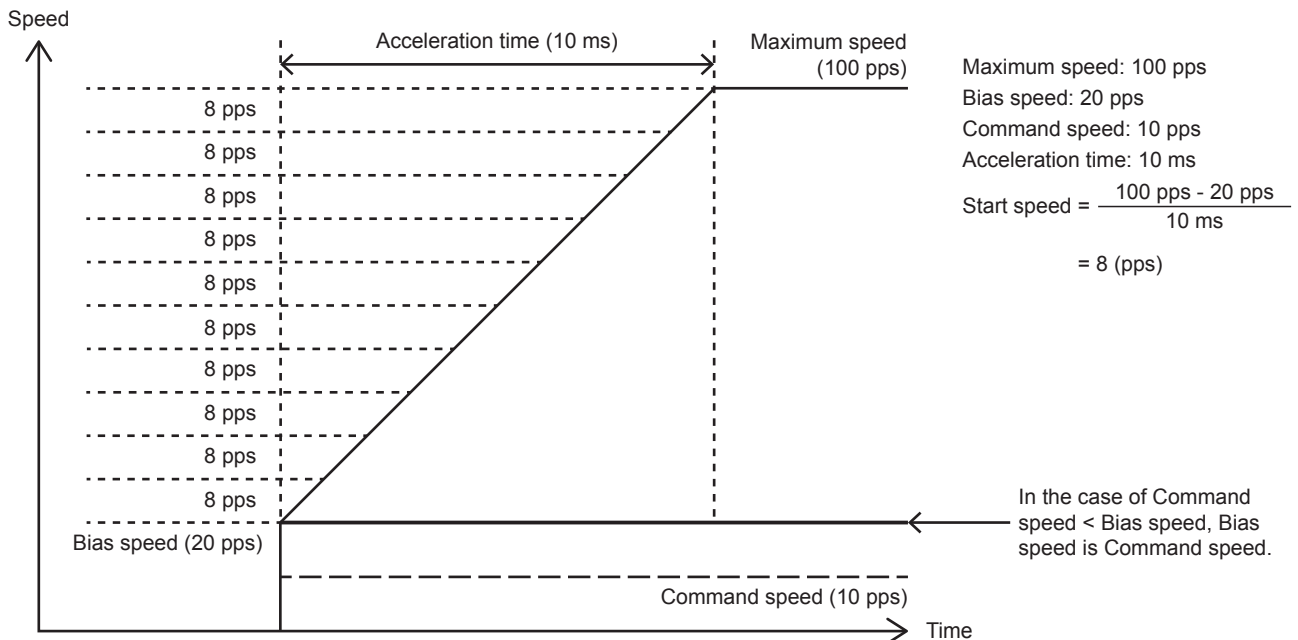

For the PLSV/DPLSV instruction and table operation instruction (control method: [4: Variable Speed Operation] or [5: Table Transition Variable Speed Operation]), the following equations are used instead of those above:

(4) Acceleration time = 0: Start speed = Command speed

(5) Acceleration time = 0: Start speed = Bias speed

## Pulse output stop

The following table lists methods to stop pulse output, other than normal completion.

Select the stop method according to whether to use deceleration (deceleration stop or immediate stop) and to use the remaining distance operation. (  Page 362 Remaining distance operation)

Operation	Deceleration <sup>*1</sup>	Abnormal end flag	Remaining distance operation	Remarks	Reference
Pulse output stop command	Immediate stop	ON	None	Immediate stop without any conditions	Page 382
All outputs disabled (SM8034)	Immediate stop	ON	None	Immediate stop without any conditions	—
Pulse decelerate and stop command	Deceleration stop	ON/OFF	Provided	With the corresponding instruction, the remaining distance operation can be used. For remaining distance operation-compatible instructions (when the remaining distance operation is enabled), the PLSV/DPLSV instruction (when unlimited pulses are output), and table operation instruction (control method: [4: Variable Speed Operation] or [5: Table Transition Variable Speed Operation]), the abnormal end flag does not turn on.	Page 383
Forward limit	Deceleration stop	ON	None	Effective only at forward rotation	Page 384
Reverse limit	Deceleration stop	ON	None	Effective only at reverse rotation	Page 384
All module reset when a stop error occurs	Immediate stop	ON	None	Immediate stop if a stop processing fails during pulse output due to a bus error Only high-speed pulse input/output module is supported.	Page 363
Turning off the instruction drive contact	Deceleration stop	ON <sup>*2</sup>	None	Deceleration stop without any conditions For the PLSY/DPLSY instruction, the PLSV/DPLSV instruction and table operation instruction (control method: [4: Variable Speed Operation] or [5: Table Transition Variable Speed Operation]), the abnormal end flag does not turn on.	—
Setting the command speed to 0	Deceleration stop	ON/OFF	None	For the PLSY/DPLSY instruction, the PLSV/DPLSV instruction and table operation instruction (control method: [4: Variable Speed Operation] or [5: Table Transition Variable Speed Operation]), the abnormal end flag does not turn on. When the command speed is changed, pulse output is restarted.	Page 360

\*1 The PLSY/DPLSY instruction is stopped immediately by all the operations.

\*2 Only the FX5 specified abnormal end flag is valid.

### Precautions

- Note that the immediate stop may damage the machine because the motor stops immediately.
- Pulse output stop takes priority over deceleration stop. Pulse outputs are immediately stopped if an immediate stop operation is performed during a deceleration stop operation.

## Operation at an error or abnormal end

The following describes operation at an error or abnormal end.

### Operation at an abnormal end

When operation of the positioning function ends with an error, pulse output is stopped.

- When an error occurs at start of a positioning instruction, pulse output is not started. Pulse output is also not started when a positioning instruction is executed with pulse output stopped, such as the pulse output stop command is on.
- When an error occurs during pulse output, deceleration stop is performed. To restart the positioning, eliminate the cause of the error that has caused the stop and then activate the positioning instruction again.
- When pulse output is stopped by an error status, the positioning instruction for the same axis cannot be activated until the drive contact of the positioning instruction is turned off or until the instruction is eliminated by online change.
- All axes except the one in which an error occurs keep operating normally. This is the same for multiple axes simultaneous activation using DRVMUL instruction. However, if an error leading to a stop occurs in one axis in interpolation operation, operation of both the axes are stopped.
- If an error occurs in table operation in the stepping operation or continuous operation, deceleration stop is performed and the tables that follow are not executed.

### Operation at an error

For the errors, refer to [Page 850 Error check](#).

## Caution

For the items specific to each positioning instruction, refer to the cautions of each instruction.

For cautions on program creation, refer to [Page 524 Cautions for Program Creation](#).

For cautions on each table operation, refer to the cautions of each control method or the corresponding positioning instruction. ([Page 490 Operations of Control Method](#))

## 32.2 Pulse Y Output

This instruction generates a pulse signal. It generates only forward rotation pulses and increases the value of the current address. Only CPU module is supported.

### PLSY/DPLSY

This instruction executes pulse output.

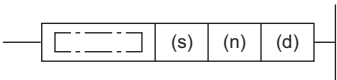
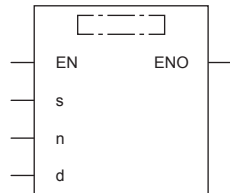
Ladder	ST	FBD/LD
	<pre>ENO:=PLSY(EN,s,n,d); ENO:=DPLSY(EN,s,n,d);</pre>	

## Setting data

### ■Description, range, data type (PLSY)

• FX5 operand

Operand	Description	Range	Data type	Data type (label)
(s)	Word device number storing command speed or data* <sup>1</sup>	0 to 65535 (User system unit)	16-bit unsigned binary	ANY16
(n)	Word device number storing the positioning address or data* <sup>2</sup>	0 to 65535 (User system unit)	16-bit unsigned binary	ANY16
(d)	Axis number from which pulses are output	■FX5S/FX5U/FX5UC CPU module K1 to K4 ■FX5UJ CPU module K1 to K3	16-bit unsigned binary	ANY_ELEMENTARY (WORD)
EN	Execution condition	—	Bit	BOOL
ENO	Execution result	—	Bit	BOOL

• FX3 compatible operand

Operand	Description	Range	Data type	Data type (label)
(s)	Word device number storing command speed or data* <sup>1</sup>	0 to 65535 (User system unit)	16-bit unsigned binary	ANY16
(n)	Word device number storing the positioning address or data* <sup>2</sup>	0 to 65535 (User system unit)	16-bit unsigned binary	ANY16
(d)	Bit device number (Y) from which pulses are output	■FX5S/FX5U/FX5UC CPU module Y0 to Y3 ■FX5UJ CPU module Y0 to Y2	Bit	ANY_ELEMENTARY (BOOL)
EN	Execution condition	—	Bit	BOOL
ENO	Execution result	—	Bit	BOOL

\*1 Command speed can be changed during positioning operation. (Page 360 Command speed change during positioning operation)

\*2 The positioning address can be changed during positioning operation. (Page 359 Positioning address change during positioning operation)

### ■Description, range, data type (DPLSY)

• FX5 operand

Operand	Description	Range	Data type	Data type (label)
(s)	Word device number storing command speed or data* <sup>1</sup>	0 to 2147483647 (User system unit)	32-bit signed binary	ANY32
(n)	Word device number storing the positioning address or data* <sup>2</sup>	0 to 2147483647 (User system unit)	32-bit signed binary	ANY32
(d)	Axis number from which pulses are output	■FX5S/FX5U/FX5UC CPU module K1 to K4 ■FX5UJ CPU module K1 to K3	16-bit unsigned binary	ANY_ELEMENTARY (WORD)
EN	Execution condition	—	Bit	BOOL
ENO	Execution result	—	Bit	BOOL



- FX3 compatible operand

Operand	Description	Range	Data type	Data type (label)
(s)	Word device number storing command speed or data <sup>*1</sup>	0 to 2147483647 (User system unit)	32-bit signed binary	ANY32
(n)	Word device number storing the positioning address or data <sup>*2</sup>	0 to 2147483647 (User system unit)	32-bit signed binary	ANY32
(d)	Bit device number (Y) from which pulses are output	<ul style="list-style-type: none"> <li>■FX5S/FX5U/FX5UC CPU module Y0 to Y3</li> <li>■FX5UJ CPU module Y0 to Y2</li> </ul>	Bit	ANY_ELEMENTARY (BOOL)
EN	Execution condition	—	Bit	BOOL
ENO	Execution result	—	Bit	BOOL

\*1 Command speed can be changed during positioning operation.

\*2 The positioning address can be changed during positioning operation.

### ■ Available device (PLSY/DPLSY)

- FX5 operand

Operand	Bit	Word				Double word		Indirect specification	Constant			Others
	X, Y, M, L, SM, F, B, SB, S	T, ST, C, D, W, SD, SW, R	U□\G□	Z	LC	LZ	K, H		E	\$		
(s)	○	○	○	○	○ <sup>*1</sup>	○ <sup>*1</sup>	○	○	—	—	—	
(n)	○	○	○	○	○ <sup>*1</sup>	○ <sup>*1</sup>	○	○	—	—	—	
(d)	—	○	○	○	—	—	○	○	—	—	—	

- FX3 compatible operand

Operand	Bit	Word				Double word		Indirect specification	Constant			Others
	X, Y, M, L, SM, F, B, SB, S	T, ST, C, D, W, SD, SW, R	U□\G□	Z	LC	LZ	K, H		E	\$		
(s)	○	○	○	○	○ <sup>*1</sup>	○ <sup>*1</sup>	○	○	—	—	—	
(n)	○	○	○	○	○ <sup>*1</sup>	○ <sup>*1</sup>	○	○	—	—	—	
(d)	○ <sup>*2</sup>	—	—	—	—	—	—	—	—	—	—	

\*1 Only available for DPLSY instruction.

\*2 FX5UJ CPU module: Only Y0 to Y2 devices can be used.

FX5S/FX5U/FX5UC CPU module: Only Y0 to Y3 devices can be used.

### Processing details

This instruction outputs pulse trains specified by the command speed (s) from the output (d) for the amount of forward rotation pulse specified by the positioning address (n).

## Related devices

The following lists the related special devices.

Related devices of axis 4 are available only for the FX5S/FX5U/FX5UC CPU module.

### Special relays

FX5 dedicated				FX3 compatible				Name	High Speed I/O Parameter	R/W	Reference
Axis 1	Axis 2	Axis 3	Axis 4	Axis 1	Axis 2	Axis 3	Axis 4				
—	—	—	—	SM8029				Instruction execution complete flag	×	R	Page 400
—	—	—	—	SM8329				Instruction execution abnormal end flag	×	R	
SM5500	SM5501	SM5502	SM5503	SM8348	SM8358	SM8368	SM8378	Positioning instruction activation	×	R	Page 398
SM5516	SM5517	SM5518	SM5519	SM8340	SM8350	SM8360	SM8370	Pulse output monitor	×	R	Page 398
SM5532	SM5533	SM5534	SM5535	—	—	—	—	Positioning error occurrence	×	R/W	Page 398
SM5628	SM5629	SM5630	SM5631	—	—	—	—	Pulse output stop command	×	R/W	Page 382
SM5644	SM5645	SM5646	SM5647	—	—	—	—	Pulse decelerate and stop command	×	R/W	Page 383
SM5660	SM5661	SM5662	SM5663	—	—	—	—	Forward limit	×	R/W	Page 384
SM5676	SM5677	SM5678	SM5679	—	—	—	—	Reverse limit	×	R/W	Page 384

R: Read only, R/W: Read/write, ×: Not supported

### Special registers

FX5 dedicated				FX3 compatible				Name	High Speed I/O Parameter	R/W	Reference
Axis 1	Axis 2	Axis 3	Axis 4	Axis 1	Axis 2	Axis 3	Axis 4				
—	—	—	—	SD8136, SD8137		—	—	Total number of pulses output from axis 1 and axis 2	×	R/W	Page 386
—	—	—	—	SD8140, SD8141	SD8142, SD8143	—	—	The number of pulse by PLSY instruction	×	R/W	Page 386
SD5500, SD5501	SD5540, SD5541	SD5580, SD5581	SD5620, SD5621	—	—	—	—	Current address (user unit)	×	R/W <sup>*1</sup>	Page 380
SD5502, SD5503	SD5542, SD5543	SD5582, SD5583	SD5622, SD5623	SD8340, SD8341	SD8350, SD8351	SD8360, SD8361	SD8370, SD8371	Current address (pulse unit)	×	R/W <sup>*1</sup>	Page 380
SD5504, SD5505	SD5544, SD5545	SD5584, SD5585	SD5624, SD5625	—	—	—	—	Current speed (user unit)	×	R	Page 376
SD5510	SD5550	SD5590	SD5630	—	—	—	—	Positioning error (error code)	×	R/W	Page 399

R: Read only, R/W: Read/write, ×: Not supported

\*1 Only FX5 dedicated devices can be written by the HCMOV/DHCMOV instruction.

# Outline of operation

For each speed, refer to Page 375 Items related to speed.

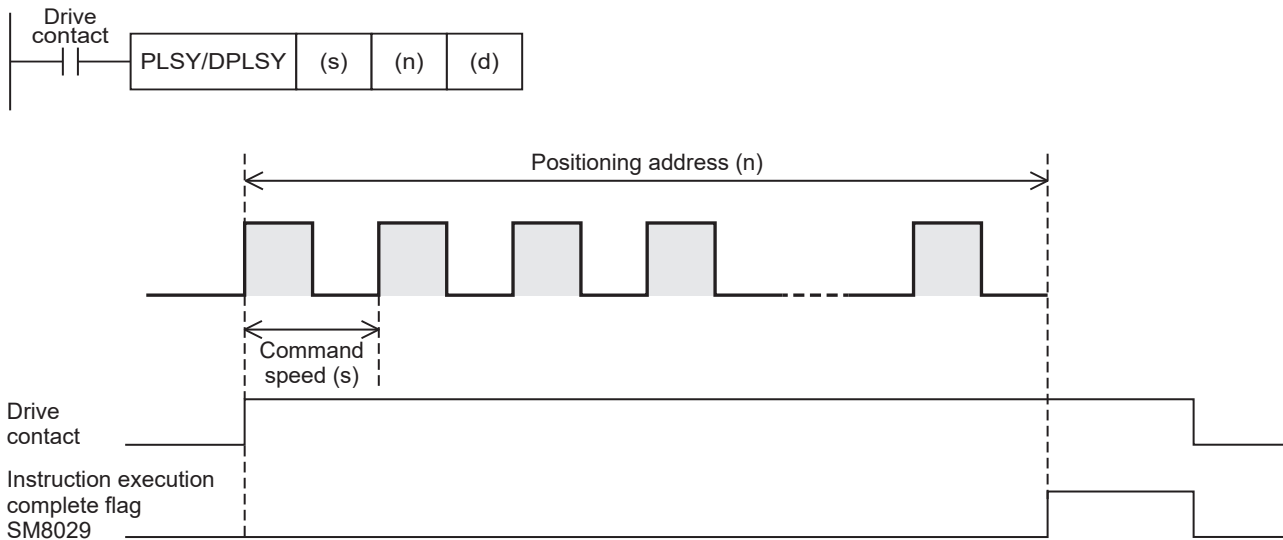

## Basic operation

The following describes the basic operation.

1. After the drive contact is turned on, pulse output is started in command speed.
2. After reached the positioning address, pulse output is stopped.

## Operand specification

### ■When FX5 operand is specified

1. For (s), specify the command speed. Set to a value 0 to 200 kpps in pulse. For the FX5S CPU module, set to a value 0 to 100 kpps.
  - PLSY: 0 to 65535 (User system unit)
  - DPLSY: 0 to 2147483647 (User system unit)
2. For (n), specify the positioning address. ( Page 378 Positioning address) Set to a value 0 to 2147483647 in pulse.
  - PLSY: 0 to 65535 (User system unit)
  - DPLSY: 0 to 2147483647 (User system unit)
3. For (d), specify an axis number for which pulses are output.

Specify an axis number whose positioning parameters are set in the high speed I/O parameters. Operation cannot be performed if any other axis number is specified.

- FX5S/FX5U/FX5UC CPU module: K1 to K4 (Axis 1 to Axis 4)
- FX5UJ CPU module: K1 to K3 (Axis 1 to Axis 3)

### ■When the FX3 compatible operand is specified

1. For (s), specify the command speed. Set to a value 0 to 200 kpps in pulse. For the FX5S CPU module, set to a value 0 to 100 kpps.
  - PLSY: 0 to 65535 (User system unit)
  - DPLSY: 0 to 2147483647 (User system unit)
2. For (n), specify the positioning address. Set to a value 0 to 2147483647 in pulse.
  - PLSY: 0 to 65535 (User system unit)
  - DPLSY: 0 to 2147483647 (User system unit)

### 3. For (d), specify the pulse output number.

Specify an output device (Y) number set in the high speed I/O parameters. (☞ Page 370 Pulse Output Mode) Operation cannot be performed if any other axis number is specified.

- FX5S/FX5U/FX5UC CPU module: Y0 to Y3 (equivalent to axes 1 to 4)
- FX5UJ CPU module: Y0 to Y2 (equivalent to axes 1 to 3)

## Direction handling

- The PLSY/DPLSY instruction always increases the current address because the setting of rotation direction is disabled due to the absence of direction. (☞ Page 372 Rotation Direction Setting)
- When the output mode is CW/CCW mode, output is always performed from the device set to CW. (☞ Page 370 Pulse Output Mode)
- If reverse limit is used, it operates as forward limit.

## Items related to speed

- If the command speed is set to 0 when the instruction is activated, the operation ends with an error.
- If the command speed is changed to 0 during operation, the operation does not end with errors but it immediately stops. As long as the drive contact is on, changing the command speed restarts pulse output.
- The acceleration time and deceleration time are disabled because acceleration and deceleration are not performed.
- The bias speed is disabled because the speed is changed immediately.

## Positioning address

- If the positioning address is 0 when the instruction is activated, unlimited pulses are output.
- When unlimited pulses are being output, the operation ends normally if the pulse decelerate and stop command is turned on.
- The operation ends with an error if the positioning address is changed to a value smaller than the number of pulses that have been output or a value outside the range during positioning operation. The positioning address becomes invalid if it is changed from 0 to a value other than 0 or from a value other than 0 to 0 during positioning operation.

## Precautions

When unlimited pulses are not being output, set the number of output pulses per PLSY/DPLSY instruction execution to 2147483647 or lower. An error occurs if the number of pulses exceeds 2147483648.

## Operation of the complete flags

The following describes the operation timings of the complete flags.

Item	FX3 compatible	
	Instruction execution complete flag (SM8029)	Instruction execution abnormal end flag (SM8329)
ON condition	<ul style="list-style-type: none"> <li>• From when pulse output of the specified positioning address is completed to when the drive contact is turned off</li> <li>• Pulse decelerate and stop command (when unlimited pulses are being output)</li> </ul>	From when the following operation or function is completed to when the drive contact is turned off <ul style="list-style-type: none"> <li>• The axis is already used.*1</li> <li>• Pulse output stop command</li> <li>• Pulse decelerate and stop command (when unlimited pulses are not being output)</li> <li>• Limit of the moving direction</li> <li>• All outputs disabled (SM8034)</li> <li>• Positioning address error</li> </ul>
ON → OFF condition	When the drive contact is turned off	

\*1 The flag turns on only for one scan when the drive contact of the instruction turns from OFF to ON.

## Program example

The following is a program example of pulse output from axis 1 (Y0).

■ Unlimited pulses output: Positioning address (operand (n)) = 0

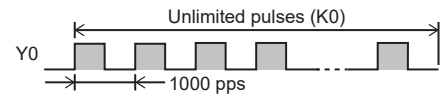
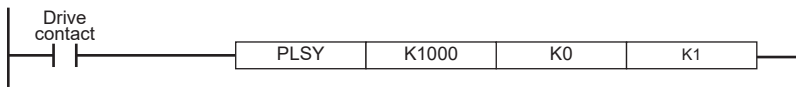

■ Pulse output: Positioning address (operand (n)) > 0

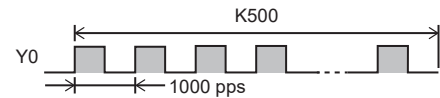
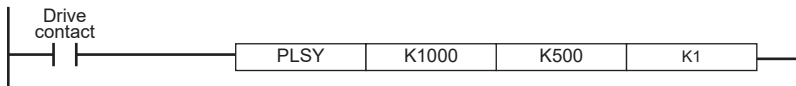

## 32.3 Mechanical OPR

If forward rotation pulses or reverse rotation pulses are generated, the positioning instruction will increase or decrease the value of the current address.

When the power of the CPU module is turned off, the value stored in the current address will be erased. For this reason, after turning on the power again, be sure to adjust the value of the current address in the CPU module to the current position of the machine. The positioning function uses the DSZR/DDSZR instruction (OPR instruction) to adjust the value of the current address in the CPU module to the current mechanical position.

### DSZR/DDSZR

This instruction executes mechanical OPR.

Ladder	ST	FBD/LD
	<pre>ENO:=DSZR(EN,s1,s2,d1,d2); ENO:=DDSZR(EN,s1,s2,d1,d2);</pre>	

32

### Setting data

#### ■ Description, range, data type (DSZR)

• FX5 operand

Operand	Description	Range	Data type	Data type (label)
(s1)	Word device number storing OPR speed or data <sup>*1</sup>	1 to 65535 (User system unit)	16-bit unsigned binary	ANY_ELEMENTARY (WORD)
(s2)	Word device number storing creep speed or data <sup>*1</sup>	1 to 65535 (User system unit)	16-bit unsigned binary	ANY_ELEMENTARY (WORD)
(d1)	Axis number from which pulses are output	<ul style="list-style-type: none"> <li>■FX5S CPU module K1 to K4</li> <li>■FX5UJ CPU module K1 to K3, K5 to K12</li> <li>■FX5U/FX5UC CPU module K1 to K12</li> </ul>	16-bit unsigned binary	ANY_ELEMENTARY (WORD)
(d2)	Bit device number of the instruction execution complete flag and abnormal end flag	—	Bit	ANY_BOOL
EN	Execution condition	—	Bit	BOOL
ENO	Execution result	—	Bit	BOOL

- FX3 compatible operand (Supported only for CPU module)

Operand	Description	Range	Data type	Data type (label)
(s1)	Bit device number to which the near-point dog signal is input	—	Bit	ANY_ELEMENTARY (BOOL)
(s2)	Bit device number to which the zero signal is input	—	Bit	ANY_ELEMENTARY (BOOL)
(d1)	Bit device number (Y) from which pulses are output	<ul style="list-style-type: none"> <li>■FX5S/FX5U/FX5UC CPU module Y0 to Y3</li> <li>■FX5UJ CPU module Y0 to Y2</li> </ul>	Bit	ANY_ELEMENTARY (BOOL)
(d2)	Bit device number from which rotation direction is output	—	Bit	ANY_BOOL
EN	Execution condition	—	Bit	BOOL
ENO	Execution result	—	Bit	BOOL

\*1 OPR speed and creep speed can be changed during positioning operation. (Page 360 Command speed change during positioning operation)

### ■Description, range, data type (DDSZR)<sup>\*1</sup>

Operand	Description	Range	Data type	Data type (label)
(s1)	Word device number storing OPR speed or data <sup>*2</sup>	1 to 2147483647 (User system unit)	32-bit signed binary	ANY32
(s2)	Word device number storing creep speed or data <sup>*2</sup>	1 to 2147483647 (User system unit)	32-bit signed binary	ANY32
(d1)	Axis number from which pulses are output	<ul style="list-style-type: none"> <li>■FX5S CPU module K1 to K4</li> <li>■FX5UJ CPU module K1 to K3, K5 to K12</li> <li>■FX5U/FX5UC CPU module K1 to K12</li> </ul>	16-bit unsigned binary	ANY16
(d2)	Bit device number of the instruction execution complete flag and abnormal end flag	—	Bit	ANY_BOOL
EN	Execution condition	—	Bit	BOOL
ENO	Execution result	—	Bit	BOOL

\*1 The DDSZR instructions have only one operand specification method.

\*2 OPR speed and creep speed can be changed during positioning operation.

### ■Available device (DSZR/DDSZR)<sup>\*1</sup>

- FX5 operand

Operand	Bit	Word			Double word		Indirect specification	Constant			Others
	X, Y, M, L, SM, F, B, SB, S	T, ST, C, D, W, SD, SW, R	U□\G□	Z	LC	LZ		K, H	E	\$	
(s1)	○	○	○	○	○ <sup>*2</sup>	○ <sup>*2</sup>	○	○	—	—	—
(s2)	○	○	○	○	○ <sup>*2</sup>	○ <sup>*2</sup>	○	○	—	—	—
(d1)	—	○	○	○	—	—	○	○	—	—	—
(d2) <sup>*3</sup>	○	○ <sup>*4</sup>	—	—	—	—	—	—	—	—	—

- FX3 compatible operand (Supported only for CPU module)

Operand	Bit	Word			Double word		Indirect specification	Constant			Others
	X, Y, M, L, SM, F, B, SB, S	T, ST, C, D, W, SD, SW, R	U□\G□	Z	LC	LZ		K, H	E	\$	
(s1)	○ <sup>5</sup>	—	—	—	—	—	—	—	—	—	—
(s2)	○ <sup>5*6</sup>	—	—	—	—	—	—	—	—	—	—
(d1)	○ <sup>7</sup>	—	—	—	—	—	—	—	—	—	—
(d2)	○ <sup>8</sup>	—	—	—	—	—	—	—	—	—	—

- \*1 The DDSZR instructions have only one operand specification method.
- \*2 Only available for DDSZR instruction.
- \*3 Two devices are occupied from the specified device.
- \*4 T, ST, C cannot be used.
- \*5 For X devices, always specify the device set in high speed I/O parameter.
- \*6 For device other than X device, set the device to which the near-point dog signal (s1) is assigned.
- \*7 FX5S/FX5U/FX5UC CPU module: Only Y0 to Y3 devices can be used.  
FX5UJ CPU module: Only Y0 to Y2 devices can be used.
- \*8 When the output mode is CW/CCW, specify the CCW axis. When the output mode is PULSE/SIGN, only the SIGN output of the axis or general-purpose output can be specified.

## Processing details

This instruction executes mechanical OPR.

With the forward limit and reverse limit, OPR using the dog search function can be executed. (  Page 356 Dog search function)

## Related devices

The following lists the related special devices.

Related devices of axis 4 are available only for the FX5S/FX5U/FX5UC CPU module.

## Special relays

### ■CPU module

FX5 dedicated				FX3 compatible				Name	High Speed I/O Parameter	R/W	Reference
Axis 1	Axis 2	Axis 3	Axis 4	Axis 1	Axis 2	Axis 3	Axis 4				
—	—	—	—	SM8029				Instruction execution complete flag	×	R	Page 400
—	—	—	—	SM8329				Instruction execution abnormal end flag	×	R	
SM5500	SM5501	SM5502	SM5503	SM8348	SM8358	SM8368	SM8378	Positioning instruction activation	×	R	Page 398
SM5516	SM5517	SM5518	SM5519	SM8340	SM8350	SM8360	SM8370	Pulse output monitor	×	R	Page 398
SM5532	SM5533	SM5534	SM5535	—	—	—	—	Positioning error occurrence	×	R/W	Page 398
SM5628	SM5629	SM5630	SM5631	—	—	—	—	Pulse output stop command	×	R/W	Page 382
SM5644	SM5645	SM5646	SM5647	—	—	—	—	Pulse decelerate and stop command	×	R/W	Page 383
SM5660	SM5661	SM5662	SM5663	—	—	—	—	Forward limit	×	R/W	Page 384
SM5676	SM5677	SM5678	SM5679	—	—	—	—	Reverse limit	×	R/W	Page 384
SM5772	SM5773	SM5774	SM5775	—	—	—	—	Rotation direction setting	○	R/W	Page 372
SM5804	SM5805	SM5806	SM5807	—	—	—	—	OPR direction specification	○	R/W	Page 387
SM5820	SM5821	SM5822	SM5823	—	—	—	—	Clear signal output function enable	○	R/W	Page 389
SM5868	SM5869	SM5870	SM5871	—	—	—	—	Zero signal count start time	○	R/W	Page 392

R: Read only, R/W: Read/write, ○: Supported, ×: Not supported

## High-speed pulse input/output module

First module		Second module		Third module		Fourth module		Name	High Speed I/O Parameter	R/W	Reference
Axis 5	Axis 6	Axis 7	Axis 8	Axis 9	Axis 10	Axis 11	Axis 12				
SM8029 (FX3 compatible device)								Instruction execution complete flag	×	R	Page 400
SM8329 (FX3 compatible device)								Instruction execution abnormal end flag	×	R	
SM5504	SM5505	SM5506	SM5507	SM5508	SM5509	SM5510	SM5511	Positioning instruction activation	×	R	Page 398
SM5520	SM5521	SM5522	SM5523	SM5524	SM5525	SM5526	SM5527	Pulse output monitor	×	R	Page 398
SM5536	SM5537	SM5538	SM5539	SM5540	SM5541	SM5542	SM5543	Positioning error occurrence	×	R/W	Page 398
SM5632	SM5633	SM5634	SM5635	SM5636	SM5637	SM5638	SM5639	Pulse output stop command	×	R/W	Page 382
SM5648	SM5649	SM5650	SM5651	SM5652	SM5653	SM5654	SM5655	Pulse decelerate and stop command	×	R/W	Page 383
SM5664	SM5665	SM5666	SM5667	SM5668	SM5669	SM5670	SM5671	Forward limit	×	R/W	Page 384
SM5680	SM5681	SM5682	SM5683	SM5684	SM5685	SM5686	SM5687	Reverse limit	×	R/W	Page 384
SM5776	SM5777	SM5778	SM5779	SM5780	SM5781	SM5782	SM5783	Rotation direction setting	○	R/W	Page 372
SM5808	SM5809	SM5810	SM5811	SM5812	SM5813	SM5814	SM5815	OPR direction specification	○	R/W	Page 387
SM5824	SM5825	SM5826	SM5827	SM5828	SM5829	SM5830	SM5831	Clear signal output function enable	○	R/W	Page 389
SM5872	SM5873	SM5874	SM5875	SM5876	SM5877	SM5878	SM5879	Zero signal count start time	○	R/W	Page 392

R: Read only, R/W: Read/write, ○: Supported, ×: Not supported

## Special registers

### CPU module

FX5 dedicated				FX3 compatible				Name	High Speed I/O Parameter	R/W	Reference
Axis 1	Axis 2	Axis 3	Axis 4	Axis 1	Axis 2	Axis 3	Axis 4				
SD5500, SD5501	SD5540, SD5541	SD5580, SD5581	SD5620, SD5621	—	—	—	—	Current address (user unit)	×	R/W <sup>*1</sup>	Page 380
SD5502, SD5503	SD5542, SD5543	SD5582, SD5583	SD5622, SD5623	SD8340, SD8341	SD8350, SD8351	SD8360, SD8361	SD8370, SD8371	Current address (pulse unit)	×	R/W <sup>*1</sup>	Page 380
SD5504, SD5505	SD5544, SD5545	SD5584, SD5585	SD5624, SD5625	—	—	—	—	Current speed (user unit)	×	R	Page 376
SD5510	SD5550	SD5590	SD5630	—	—	—	—	Positioning error (error code)	×	R/W	Page 399
SD5516, SD5517	SD5556, SD5557	SD5596, SD5597	SD5636, SD5637	—	—	—	—	Maximum speed	○	R/W	Page 377
SD5518, SD5519	SD5558, SD5559	SD5598, SD5599	SD5638, SD5639	—	—	—	—	Bias speed	○	R/W	Page 377
SD5520	SD5560	SD5600	SD5640	—	—	—	—	Acceleration time	○	R/W	Page 378
SD5521	SD5561	SD5601	SD5641	—	—	—	—	Deceleration time	○	R/W	Page 378
SD5526, SD5527	SD5566, SD5567	SD5606, SD5607	SD5646, SD5647	—	—	—	—	OPR speed	○	R/W	Page 388
SD5528, SD5529	SD5568, SD5569	SD5608, SD5609	SD5648, SD5649	—	—	—	—	Creep speed	○	R/W	Page 389
SD5530, SD5531	SD5570, SD5571	SD5610, SD5611	SD5650, SD5651	—	—	—	—	Origin address	○	R/W	Page 388
SD5532	SD5572	SD5612	SD5652	—	—	—	—	OPR zero signal counts	○	R/W	Page 392
SD5533	SD5573	SD5613	SD5653	—	—	—	—	OPR dwell time	○	R/W	Page 390

R: Read only, R/W: Read/write, ○: Supported, ×: Not supported

\*1 Only FX5 dedicated devices can be written by the HCMOV/DHMOV instruction.



## High-speed pulse input/output module

First module		Second module		Third module		Fourth module		Name	High Speed I/O Parameter	R/W	Reference
Axis 5	Axis 6	Axis 7	Axis 8	Axis 9	Axis 10	Axis 11	Axis 12				
SD5660, SD5661	SD5700, SD5701	SD5740, SD5741	SD5780, SD5781	SD5820, SD5821	SD5860, SD5861	SD5900, SD5901	SD5940, SD5941	Current address (user unit)	×	R/W <sup>*1</sup>	Page 380
SD5662, SD5663	SD5702, SD5703	SD5742, SD5743	SD5782, SD5783	SD5822, SD5823	SD5862, SD5863	SD5902, SD5903	SD5942, SD5943	Current address (pulse unit)	×	R/W <sup>*1</sup>	Page 380
SD5664, SD5665	SD5704, SD5705	SD5744, SD5745	SD5784, SD5785	SD5824, SD5825	SD5864, SD5865	SD5904, SD5905	SD5944, SD5945	Current speed (user unit)	×	R	Page 376
SD5670	SD5710	SD5750	SD5790	SD5830	SD5870	SD5910	SD5950	Positioning error (error code)	×	R/W	Page 399
SD5676, SD5677	SD5716, SD5717	SD5756, SD5757	SD5796, SD5797	SD5836, SD5837	SD5876, SD5877	SD5916, SD5917	SD5956, SD5957	Maximum speed	○	R/W	Page 377
SD5678, SD5679	SD5718, SD5719	SD5758, SD5759	SD5798, SD5799	SD5838, SD5839	SD5878, SD5879	SD5918, SD5919	SD5958, SD5959	Bias speed	○	R/W	Page 377
SD5680	SD5720	SD5760	SD5800	SD5840	SD5880	SD5920	SD5960	Acceleration time	○	R/W	Page 378
SD5681	SD5721	SD5761	SD5801	SD5841	SD5881	SD5921	SD5961	Deceleration time	○	R/W	Page 378
SD5686, SD5687	SD5726, SD5727	SD5766, SD5767	SD5806, SD5807	SD5846, SD5847	SD5886, SD5887	SD5926, SD5927	SD5966, SD5967	OPR speed	○	R/W	Page 388
SD5688, SD5689	SD5728, SD5729	SD5768, SD5769	SD5808, SD5809	SD5848, SD5849	SD5888, SD5889	SD5928, SD5929	SD5968, SD5969	Creep speed	○	R/W	Page 389
SD5690, SD5691	SD5730, SD5731	SD5770, SD5771	SD5810, SD5811	SD5850, SD5851	SD5890, SD5891	SD5930, SD5931	SD5970, SD5971	Origin address	○	R/W	Page 388
SD5692	SD5732	SD5772	SD5812	SD5852	SD5892	SD5932	SD5972	OPR zero signal counts	○	R/W	Page 392
SD5693	SD5733	SD5773	SD5813	SD5853	SD5893	SD5933	SD5973	OPR dwell time	○	R/W	Page 390

R: Read only, R/W: Read/write, ○: Supported, ×: Not supported

\*1 Writing can be performed only by the HCMOV/DHCMOV instruction.

# Outline of operation

For each speed, refer to Page 375 Items related to speed.

For the items related to OPR, refer to Page 387 Items related to OPR.

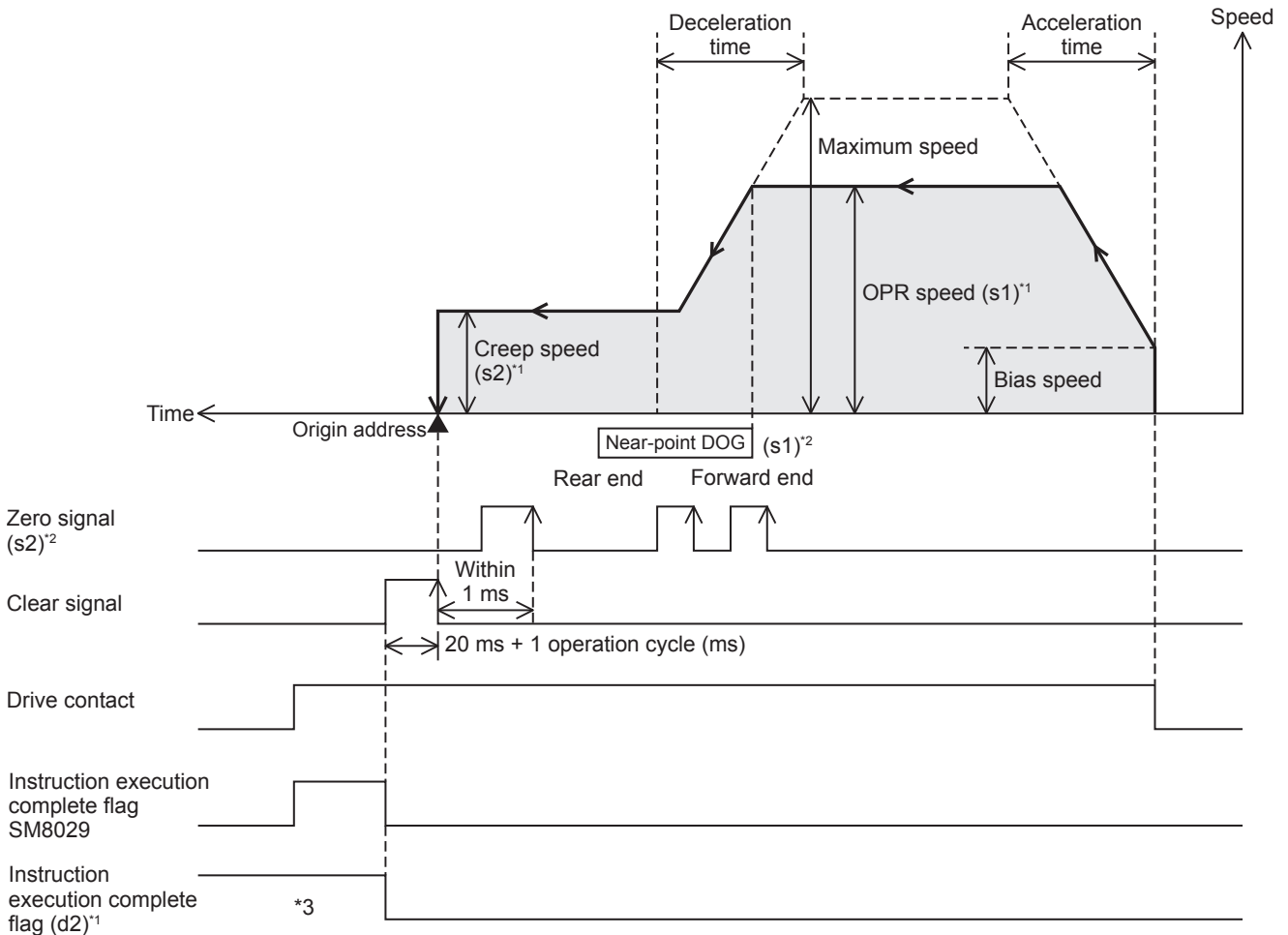
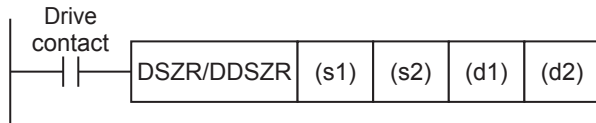

\*1 When FX5 operand is specified

\*2 When the FX3 compatible operand is specified

\*3 Remains on until it is turned off using program or engineering tool or the positioning instruction is next driven again.

## Basic operation

The following describes the basic operation.

1. After the drive contact is turned on, pulse output is started and the speed is increased from the bias speed.
2. After the speed has reached the OPR speed, the operation will be performed at the OPR speed.
3. After the near-point dog is detected, the speed is decreased.
4. After the speed has reached the creep speed, the operation will be performed at the creep speed.
5. After the near-point dog is turned from ON to OFF, pulse output is stopped when the zero signal is detected.

## Operand specification

### ■When FX5 operand is specified or the DDSZR instruction is used

**1.** For (s1), specify the OPR speed. Set to a value 1 pps to 200 kpps in pulse. For the FX5S CPU module, set to a value 1 to 100 kpps.

- DSZR: 1 to 65535 (User system unit)
- DDSZR: 1 to 2147483647 (User system unit)

**2.** For (s2), specify the creep speed. Set to a value 1 pps to 200 kpps in pulse. For the FX5S CPU module, set to a value 1 to 100 kpps.

- DSZR: 1 to 65535 (User system unit)
- DDSZR: 1 to 2147483647 (User system unit)

**3.** For (d1), specify an axis number for which pulses are output.

Specify an axis number whose positioning parameters are set in the high speed I/O parameters. Operation cannot be performed if any other axis number is specified.

[FX5S CPU module]

- K1 to K4: Axis 1 to Axis 4

[FX5UJ CPU module]

- K1 to K3: Axis 1 to Axis 3 (CPU module)
- K5, K6: Axis 5, Axis 6 (High-speed pulse input/output module first module)
- K7, K8: Axis 7, Axis 8 (High-speed pulse input/output module second module)
- K9, K10: Axis 9, Axis 10 (High-speed pulse input/output module third module)
- K11, K12: Axis 11, Axis 12 (High-speed pulse input/output module fourth module)

[FX5U/FX5UC CPU module]

- K1 to K4: Axis 1 to Axis 4 (CPU module)
- K5, K6: Axis 5, Axis 6 (High-speed pulse input/output module first module)
- K7, K8: Axis 7, Axis 8 (High-speed pulse input/output module second module)
- K9, K10: Axis 9, Axis 10 (High-speed pulse input/output module third module)
- K11, K12: Axis 11, Axis 12 (High-speed pulse input/output module fourth module)

**4.** For (d2), specify the bit devices of the instruction execution complete flag and abnormal end flag. (📖 Page 400 Complete flag)

- (d2): Instruction execution complete flag
- (d2)+1: Instruction execution abnormal end flag

### ■When the FX3 compatible operand is specified (Supported only for CPU module)

**1.** For (s1), specify the near-point dog signal input device number.

When an input device (X) is used, only the device that is specified with the high speed I/O parameter can be specified. The logic set with the high speed I/O parameter is applied. Bit devices can be specified, in addition to input devices (X). In that case, the relay operates on a rising edge.

**2.** For (s2), specify the zero signal input device number.

When an input device (X) is used, only the device that is specified with the high speed I/O parameter can be specified. The logic set with the high speed I/O parameter is applied. Bit devices can be specified, in addition to input devices (X). In that case, the relay operates on a rising edge.

**3.** For (d1), specify the pulse output number.

Specify an output device (Y) number set in the high speed I/O parameters. (📖 Page 370 Pulse Output Mode) Operation cannot be performed if any other axis number is specified.

- FX5S/FX5U/FX5UC CPU module: Y0 to Y3 (equivalent to axes 1 to 4)
- FX5UJ CPU module: Y0 to Y2 (equivalent to axes 1 to 3)

4. For (d2), specify the rotation direction signal output device number. (Page 372 Rotation Direction Setting)  
 When an output device (Y) is used, only the device that is specified with the positioning parameter or a general-purpose output can be specified. However, if an output device (Y) to which PWM, PULSE/SIGN axis of another axis, or CW/CCW axis is assigned is specified, an error occurs without any operation.

For the PWM function, refer to the following.

Page 319 PWM Function

## OPR direction

The pulse output direction is determined by the OPR direction and rotation direction setting. The following table lists operations performed when the origin return direction and rotation direction setting are used in combination. (Page 372 Rotation Direction Setting)

Item		Rotation Direction Setting	
		Current Value Increment with Forward Run Pulse Output	Current Value Increment with Reverse Run Pulse Output
OPR Direction	Positive Direction (Address Increment Direction)	Output direction: Forward Address: Increment	Output direction: Reverse Address: Increment
	Negative Direction (Address Decrement Direction)	Output direction: Reverse Address: Decrement	Output direction: Forward Address: Decrement

## Operand change in positioning operation

During positioning operation for the OPR speed (s1) and creep speed (s2), the command speed can be changed before the zero signal is detected. If it is changed after the zero signal is detected, the change is applied when the DSZR/DDSZR instruction is next driven again.

## Operation of the complete flags

The following describes the operation timings of the complete flags.

The user-specified complete flags are valid only when specified using FX5 operand. If dwell time is specified, the user-specified complete flag turns on after the dwell time elapses.

Item	FX3 compatible		User specification	
	Instruction execution complete flag (SM8029)	Instruction execution abnormal end flag (SM8329)	Instruction execution complete flag (d2)	Instruction execution abnormal end flag (d2)+1
ON condition	From when OPR is completed to when the drive contact is turned off	From when the following operation or function is completed to when the drive contact is turned off <ul style="list-style-type: none"> <li>The axis is already used.*1</li> <li>Pulse output stop command</li> <li>Pulse decelerate and stop command</li> <li>All module reset when a stop error occurs*2</li> <li>All outputs disabled (SM8034)</li> <li>Origin address error</li> <li>Deceleration stop after OPR speed and creep speed are changed to 0</li> <li>Deceleration stop at limit detection after the near-point dog is detected</li> </ul>	From when OPR is completed to when the ON → OFF condition is met	From when the following operation or function is completed to when the ON → OFF condition is met <ul style="list-style-type: none"> <li>The axis is already used.</li> <li>The drive contact is turned off during positioning operation</li> <li>Pulse output stop command</li> <li>Pulse decelerate and stop command</li> <li>All module reset when a stop error occurs*2</li> <li>All outputs disabled (SM8034)</li> <li>Online change</li> <li>Origin address error</li> <li>Deceleration stop after OPR speed and creep speed are changed to 0</li> <li>Deceleration stop at limit detection after the near-point dog is detected</li> </ul>
ON → OFF condition	When the drive contact is turned off		The flag remains on until either of the following is performed. <ul style="list-style-type: none"> <li>Turning off the flag by the user</li> <li>Restarting the positioning instruction</li> </ul>	

\*1 The flag turns on only for one scan when the drive contact of the instruction turns from OFF to ON.

\*2 Only high-speed pulse input/output module is supported.

# Program example

The following is a program example of OPR operation (axis 1).

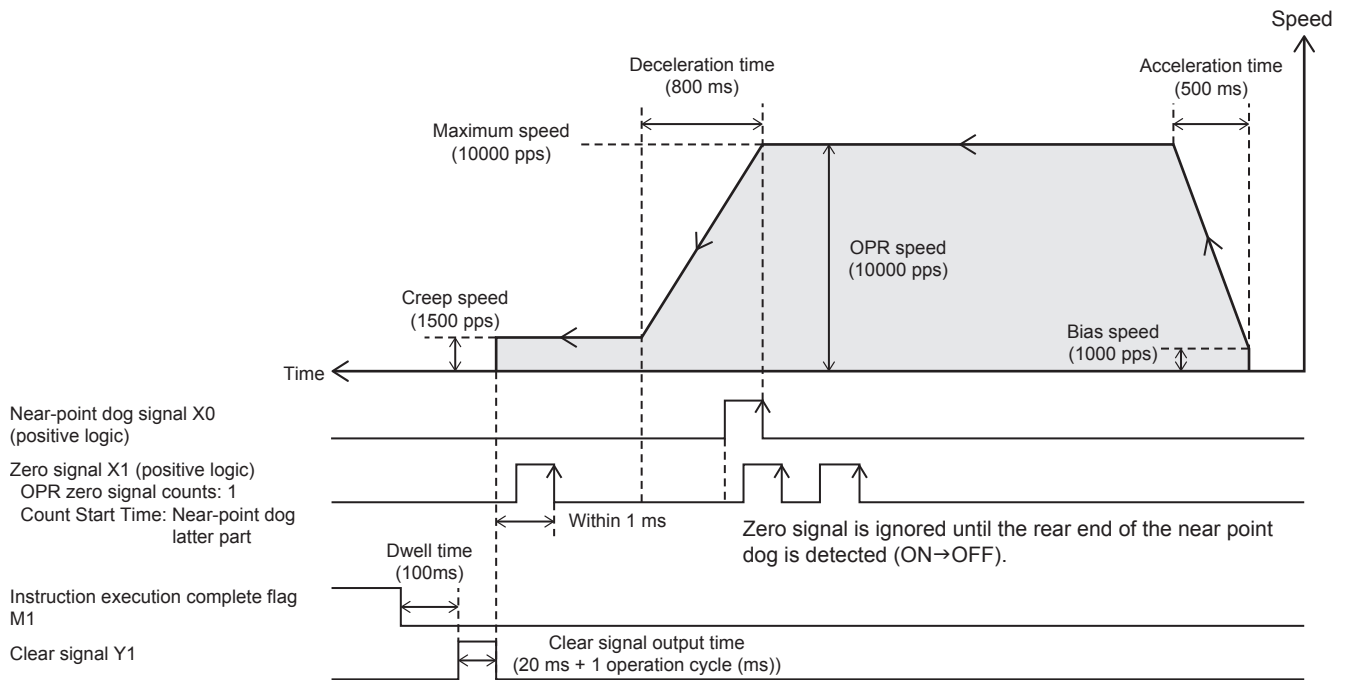

## Setting data

### Positioning parameter (high speed I/O parameter)

Item	Axis 1	Item	Axis 1
■Basic Parameter 1		■Detailed Setting Parameter	
Pulse Output Mode	1: PULSE/SIGN	External Start Signal Enabled/ Disabled	0: Disabled
Output Device (PULSE/CW)	Y0	Interrupt Input Signal 1 Enabled/ Disabled	0: Disabled
Output Device (SIGN/CCW)	Y4	Interrupt Input Signal 2 Logic	0: Positive Logic
Rotation Direction Setting	0: Current Address Increment with Forward Run Pulse Output	■OPR Parameter	
Unit Setting	0: Motor System (pulse, pps)	OPR Enabled/Disabled	1: Enabled
No. of Pulse per Rotation	2000 pulse	OPR Direction	0: Negative Direction (Address Decrement Direction)
Movement Amount per Rotation	1000 pulse	Starting Point Address	0 pulse
Position Data Magnification	1: × Single	Clear Signal Output Enabled/ Disabled	1: Enabled
■Basic Parameter 2		Clear Signal Output Device No.	Y1
Interpolation Speed Specified Method	0: Composite Speed	OPR Dwell Time	100 ms
Max. Speed	10000 pps	Near-point Dog Signal Device No.	X0
Bias Speed	1000 pps	Near-point Dog Signal Logic	0: Positive Logic
Acceleration Time	500 ms	Zero Signal Device No.	X1
Deceleration Time	800 ms	Zero Signal Logic	0: Positive Logic
—		Zero Signal OPR Zero Signal Counts	1
—		Zero Signal Count Start Time	0: Near-point Dog Latter Part

## Program example

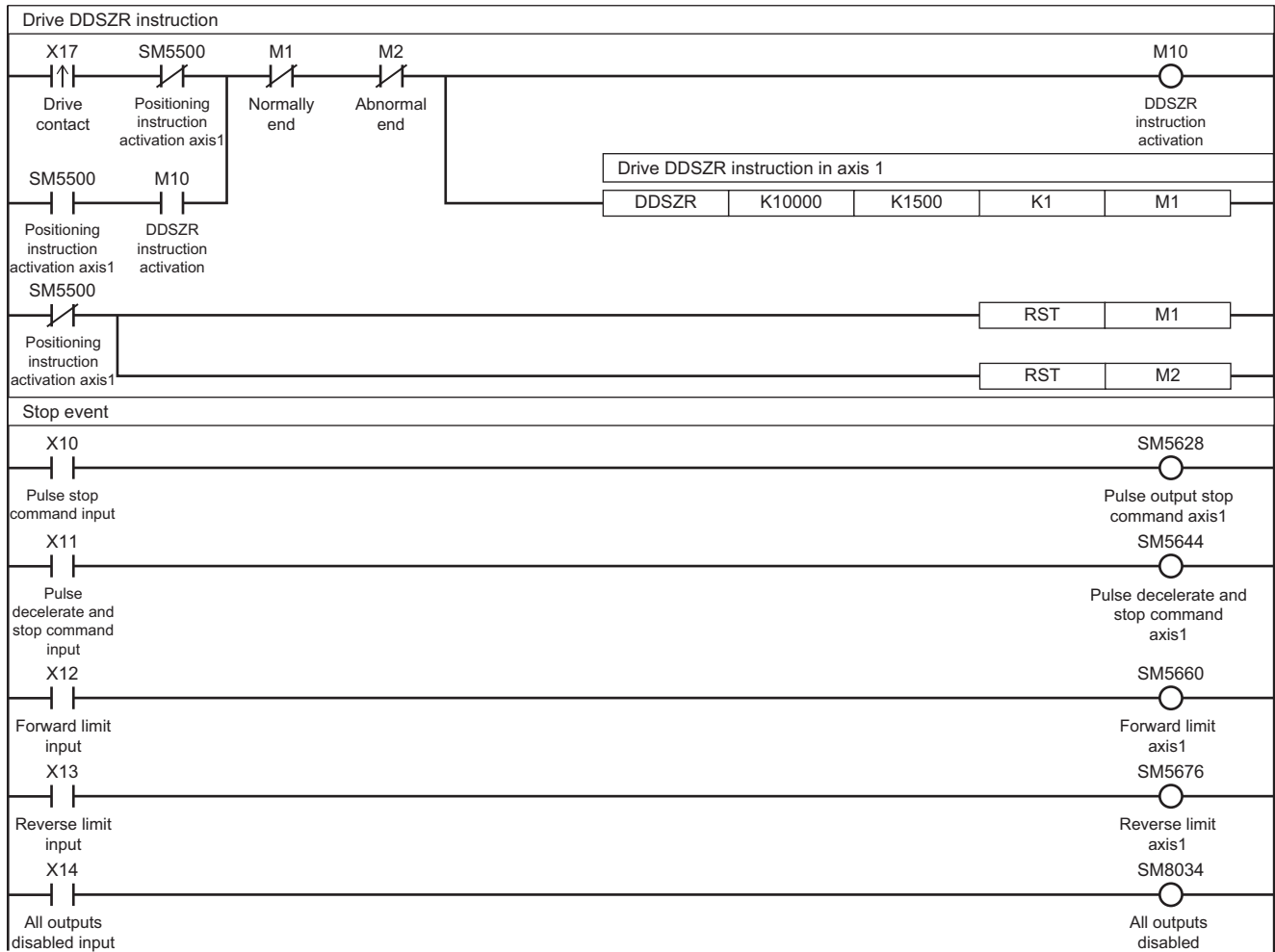

## Caution

- Detection of (the rear end and the front end of) the near-point dog will be affected by the input response time and the scan time of the sequence program. Secure 1 scan time or more from the rear end of the near-point dog to turning ON of the zero signal.
- Since the zero signal of the servo motor is used, adjust the relation between the rear end of the near-point dog and the zero signal as shown in the following figure. If fine adjustment of the origin position is needed, adjust the position of the near-point dog.

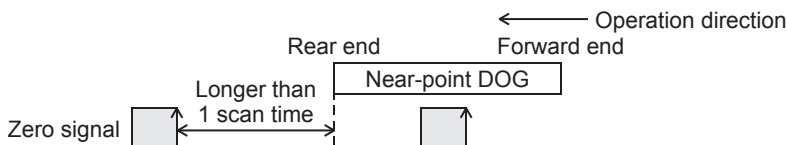

- Properly set the near-point dog so that the near-point dog can be kept at the ON status until the speed is reduced to the creep speed. Deceleration to the creep speed starts at the front end of the near-point dog, the operation stops at "the rear end of the near-point dog" or at "detection of the first zero signal after the rear end of the near-point dog", and the current address is cleared. If the speed is not reduced to the creep speed before detecting the rear end of the near-point dog, the operation may not be stopped at the specified position.

- Use the near-point dog between the reverse rotation limit 1 (LSR) and the forward rotation limit 1 (LSF). The intended operation may not be performed if the relationship among the near-point dog, reverse rotation limit 1 (LSR), and forward rotation limit 1 (LSF) is not as shown in the figure below.

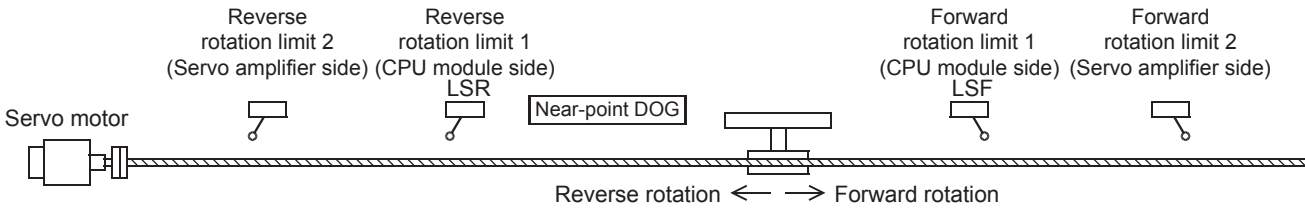

- The creep speed should be sufficiently slow. Deceleration stop is not performed. For this reason, if the creep speed is not slow enough, the operation may not be stopped at the specified position due to inertia.
- When using the high-speed pulse input/output module with OPR zero signal counts set to 0, the position of the origin position varies under influence of the calculation period. If an operation to stop immediately after the detection of the dog signal is made, executing OPR with the following setting reduces the variance of the origin position. However, it is necessary to adjust the length of the near-point dog signal so that the time of OFF to ON of the near-point dog signal is one scan or longer.

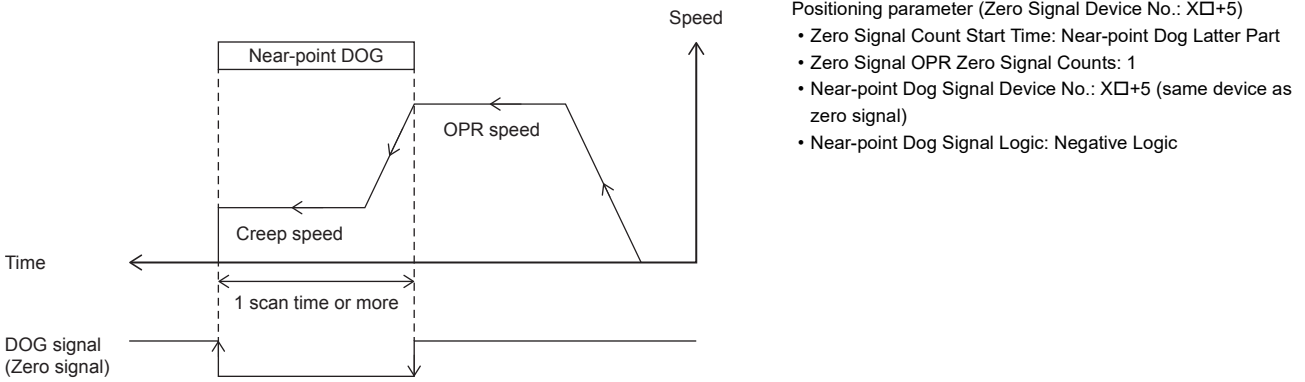

- If the dog search function cannot detect the near-point dog signal, the speed will decelerate and the operation will stop. The execution of the instruction ends with an error.
- In the case of the high-speed pulse input/output module, if the CJ instruction is used to skip the DSZR/DDSZR instruction, the near-point dog signals become undetectable. (Page 525 When a user interrupt is used) If the instruction is skipped, the operation to detect the forward limit or reverse limit and stop is made.

## 32.4 Relative Positioning

This instruction performs 1-speed positioning in the incremental method (positioning operation with a relative address). While regarding the current position as the start point, specify the transfer direction and the transfer distance (relative address) to determine the target position.

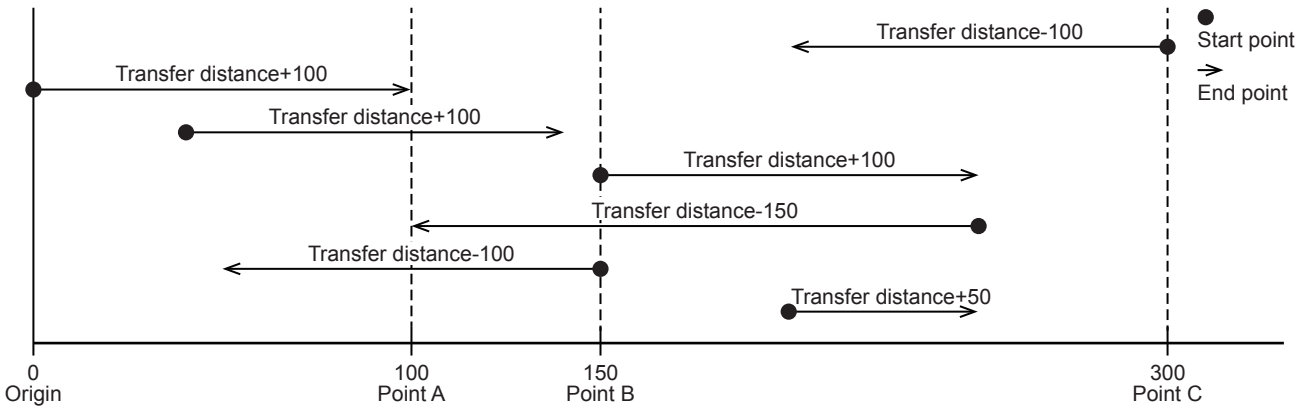

## DRVI/DDRVI

This instruction executes 1-speed positioning by relative address.

Ladder	ST	FBD/LD
	<pre>ENO:=DRVI(EN,s1,s2,d1,d2); ENO:=DDRVI(EN,s1,s2,d1,d2);</pre>	

### Setting data

#### ■Description, range, data type (DRVI)

- FX5 operand

Operand	Description	Range	Data type	Data type (label)
(s1)	Word device number storing the positioning address or data*1	-32768 to +32767 (User system unit)	16-bit signed binary	ANY16
(s2)	Word device number storing command speed or data*2	1 to 65535 (User system unit)	16-bit unsigned binary	ANY16
(d1)	Axis number from which pulses are output	<ul style="list-style-type: none"> <li>■FX5S CPU module K1 to K4</li> <li>■FX5UJ CPU module K1 to K3, K5 to K12</li> <li>■FX5U/FX5UC CPU module K1 to K12</li> </ul>	16-bit unsigned binary	ANY_ELEMENTARY (WORD)
(d2)	Bit device number of the instruction execution complete flag and abnormal end flag	—	Bit	ANY_BOOL
EN	Execution condition	—	Bit	BOOL
ENO	Execution result	—	Bit	BOOL

- FX3 compatible operand (Supported only for CPU module)

Operand	Description	Range	Data type	Data type (label)
(s1)	Word device number storing the positioning address or data*1	-32768 to +32767 (User system unit)	16-bit signed binary	ANY16
(s2)	Word device number storing command speed or data*2	1 to 65535 (User system unit)	16-bit unsigned binary	ANY16
(d1)	Bit device number (Y) from which pulses are output	<ul style="list-style-type: none"> <li>■FX5S/FX5U/FX5UC CPU module Y0 to Y3</li> <li>■FX5UJ CPU module Y0 to Y2</li> </ul>	Bit	ANY_ELEMENTARY (BOOL)
(d2)	Bit device number from which rotation direction is output	—	Bit	ANY_BOOL
EN	Execution condition	—	Bit	BOOL
ENO	Execution result	—	Bit	BOOL

\*1 The positioning address can be changed during positioning operation. ( Page 359 Positioning address change during positioning operation)

\*2 Command speed can be changed during positioning operation. ( Page 360 Command speed change during positioning operation)



## ■Description, range, data type (DDRVI)

• FX5 operand

Operand	Description	Range	Data type	Data type (label)
(s1)	Word device number storing the positioning address or data <sup>*1</sup>	-2147483648 to +2147483647 (User system unit)	32-bit signed binary	ANY32
(s2)	Word device number storing command speed or data <sup>*2</sup>	1 to 2147483647 (User system unit)	32-bit signed binary	ANY32
(d1)	Axis number from which pulses are output	■FX5S CPU module K1 to K4 ■FX5UJ CPU module K1 to K3, K5 to K12 ■FX5U/FX5UC CPU module K1 to K12	16-bit unsigned binary	ANY_ELEMENTARY (WORD)
(d2)	Bit device number of the instruction execution complete flag and abnormal end flag	—	Bit	ANY_BOOL
EN	Execution condition	—	Bit	BOOL
ENO	Execution result	—	Bit	BOOL

• FX3 compatible operand (Supported only for CPU module)

Operand	Description	Range	Data type	Data type (label)
(s1)	Word device number storing the positioning address or data <sup>*1</sup>	-2147483648 to +2147483647 (User system unit)	32-bit signed binary	ANY32
(s2)	Word device number storing command speed or data <sup>*2</sup>	1 to 2147483647 (User system unit)	32-bit signed binary	ANY32
(d1)	Bit device number (Y) from which pulses are output	■FX5S/FX5U/FX5UC CPU module Y0 to Y3 ■FX5UJ CPU module Y0 to Y2	Bit	ANY_ELEMENTARY (BOOL)
(d2)	Bit device number from which rotation direction is output	—	Bit	ANY_BOOL
EN	Execution condition	—	Bit	BOOL
ENO	Execution result	—	Bit	BOOL

\*1 The positioning address can be changed during positioning operation.

\*2 Command speed can be changed during positioning operation.

## ■Available device (DRVI/DDRVI)

• FX5 operand

Operand	Bit	Word			Double word		Indirect specification	Constant			Others
	X, Y, M, L, SM, F, B, SB, S	T, ST, C, D, W, SD, SW, R	U□\G□	Z	LC	LZ		K, H	E	\$	
(s1)	○	○	○	○	○ <sup>*1</sup>	○ <sup>*1</sup>	○	○	—	—	—
(s2)	○	○	○	○	○ <sup>*1</sup>	○ <sup>*1</sup>	○	○	—	—	—
(d1)	—	○	○	○	—	—	○	○	—	—	—
(d2) <sup>*2</sup>	○	○ <sup>*3</sup>	—	—	—	—	—	—	—	—	—

- FX3 compatible operand (Supported only for CPU module)

Operand	Bit	Word			Double word		Indirect specification	Constant			Others
	X, Y, M, L, SM, F, B, SB, S	T, ST, C, D, W, SD, SW, R	U□\G□	Z	LC	LZ		K, H	E	\$	
(s1)	○	○	○	○	○ <sup>*1</sup>	○ <sup>*1</sup>	○	○	—	—	—
(s2)	○	○	○	○	○ <sup>*1</sup>	○ <sup>*1</sup>	○	○	—	—	—
(d1)	○ <sup>*4</sup>	—	—	—	—	—	—	—	—	—	—
(d2)	○ <sup>*5</sup>	○ <sup>*3</sup>	—	—	—	—	—	—	—	—	—

\*1 Only available for DDRVI instruction.

\*2 Two devices are occupied from the specified device.

\*3 T, ST, C cannot be used.

\*4 FX5S/FX5U/FX5UC CPU module: Only Y0 to Y3 devices can be used.

FX5UJ CPU module: Only Y0 to Y2 devices can be used.

\*5 When the output mode is CW/CCW, specify the CCW axis. When the output mode is PULSE/SIGN, only the SIGN output of the axis or general-purpose output can be specified.

## Processing details

This instruction executes 1-speed positioning by relative address. The target positioning address is specified in the incremental method, in which transfer direction and transfer distance (relative address) from current address are specified for positioning operation.

## Related devices

The following lists the related special devices.

Related devices of axis 4 are available only for the FX5S/FX5U/FX5UC CPU module.

## Special relays

### ■CPU module

FX5 dedicated				FX3 compatible				Name	High Speed I/O Parameter	R/W	Reference
Axis 1	Axis 2	Axis 3	Axis 4	Axis 1	Axis 2	Axis 3	Axis 4				
—	—	—	—	SM8029				Instruction execution complete flag	×	R	Page 400
—	—	—	—	SM8329				Instruction execution abnormal end flag	×	R	
SM5500	SM5501	SM5502	SM5503	SM8348	SM8358	SM8368	SM8378	Positioning instruction activation	×	R	Page 398
SM5516	SM5517	SM5518	SM5519	SM8340	SM8350	SM8360	SM8370	Pulse output monitor	×	R	Page 398
SM5532	SM5533	SM5534	SM5535	—	—	—	—	Positioning error occurrence	×	R/W	Page 398
SM5596	SM5597	SM5598	SM5599	—	—	—	—	Remaining distance operation enabled	×	R/W	Page 385
SM5612	SM5613	SM5614	SM5615	—	—	—	—	Remaining distance operation start	×	R/W	Page 385
SM5628	SM5629	SM5630	SM5631	—	—	—	—	Pulse output stop command	×	R/W	Page 382
SM5644	SM5645	SM5646	SM5647	—	—	—	—	Pulse decelerate and stop command	×	R/W	Page 383
SM5660	SM5661	SM5662	SM5663	—	—	—	—	Forward limit	×	R/W	Page 384
SM5676	SM5677	SM5678	SM5679	—	—	—	—	Reverse limit	×	R/W	Page 384
SM5772	SM5773	SM5774	SM5775	—	—	—	—	Rotation direction setting	○	R/W	Page 372

R: Read only, R/W: Read/write, ○: Supported, ×: Not supported

## High-speed pulse input/output module

First module		Second module		Third module		Fourth module		Name	High Speed I/O Parameter	R/W	Reference
Axis 5	Axis 6	Axis 7	Axis 8	Axis 9	Axis 10	Axis 11	Axis 12				
SM8029 (FX3 compatible device)								Instruction execution complete flag	×	R	Page 400
SM8329 (FX3 compatible device)								Instruction execution abnormal end flag	×	R	
SM5504	SM5505	SM5506	SM5507	SM5508	SM5509	SM5510	SM5511	Positioning instruction activation	×	R	Page 398
SM5520	SM5521	SM5522	SM5523	SM5524	SM5525	SM5526	SM5527	Pulse output monitor	×	R	Page 398
SM5536	SM5537	SM5538	SM5539	SM5540	SM5541	SM5542	SM5543	Positioning error occurrence	×	R/W	Page 398
SM5600	SM5601	SM5602	SM5603	SM5604	SM5605	SM5606	SM5607	Remaining distance operation enabled	×	R/W	Page 385
SM5616	SM5617	SM5618	SM5619	SM5620	SM5621	SM5622	SM5623	Remaining distance operation start	×	R/W	Page 385
SM5632	SM5633	SM5634	SM5635	SM5636	SM5637	SM5638	SM5639	Pulse output stop command	×	R/W	Page 382
SM5648	SM5649	SM5650	SM5651	SM5652	SM5653	SM5654	SM5655	Pulse decelerate and stop command	×	R/W	Page 383
SM5664	SM5665	SM5666	SM5667	SM5668	SM5669	SM5670	SM5671	Forward limit	×	R/W	Page 384
SM5680	SM5681	SM5682	SM5683	SM5684	SM5685	SM5686	SM5687	Reverse limit	×	R/W	Page 384
SM5776	SM5777	SM5778	SM5779	SM5780	SM5781	SM5782	SM5783	Rotation direction setting	○	R/W	Page 372

R: Read only, R/W: Read/write, ○: Supported, ×: Not supported

## Special registers

### CPU module

FX5 dedicated				FX3 compatible				Name	High Speed I/O Parameter	R/W	Reference
Axis 1	Axis 2	Axis 3	Axis 4	Axis 1	Axis 2	Axis 3	Axis 4				
SD5500, SD5501	SD5540, SD5541	SD5580, SD5581	SD5620, SD5621	—	—	—	—	Current address (user unit)	×	R/W <sup>*1</sup>	Page 380
SD5502, SD5503	SD5542, SD5543	SD5582, SD5583	SD5622, SD5623	SD8340, SD8341	SD8350, SD8351	SD8360, SD8361	SD8370, SD8371	Current address (pulse unit)	×	R/W <sup>*1</sup>	Page 380
SD5504, SD5505	SD5544, SD5545	SD5584, SD5585	SD5624, SD5625	—	—	—	—	Current speed (user unit)	×	R	Page 376
SD5510	SD5550	SD5590	SD5630	—	—	—	—	Positioning error (error code)	×	R/W	Page 399
SD5516, SD5517	SD5556, SD5557	SD5596, SD5597	SD5636, SD5637	—	—	—	—	Maximum speed	○	R/W	Page 377
SD5518, SD5519	SD5558, SD5559	SD5598, SD5599	SD5638, SD5639	—	—	—	—	Bias speed	○	R/W	Page 377
SD5520	SD5560	SD5600	SD5640	—	—	—	—	Acceleration time	○	R/W	Page 378
SD5521	SD5561	SD5601	SD5641	—	—	—	—	Deceleration time	○	R/W	Page 378

R: Read only, R/W: Read/write, ○: Supported, ×: Not supported

\*1 Only FX5 dedicated devices can be written by the HCMOV/DHCMOV instruction.

## High-speed pulse input/output module

First module		Second module		Third module		Fourth module		Name	High Speed I/O Parameter	R/W	Reference
Axis 5	Axis 6	Axis 7	Axis 8	Axis 9	Axis 10	Axis 11	Axis 12				
SD5660, SD5661	SD5700, SD5701	SD5740, SD5741	SD5780, SD5781	SD5820, SD5821	SD5860, SD5861	SD5900, SD5901	SD5940, SD5941	Current address (user unit)	×	R/W <sup>*1</sup>	Page 380
SD5662, SD5663	SD5702, SD5703	SD5742, SD5743	SD5782, SD5783	SD5822, SD5823	SD5862, SD5863	SD5902, SD5903	SD5942, SD5943	Current address (pulse unit)	×	R/W <sup>*1</sup>	Page 380
SD5664, SD5665	SD5704, SD5705	SD5744, SD5745	SD5784, SD5785	SD5824, SD5825	SD5864, SD5865	SD5904, SD5905	SD5944, SD5945	Current speed (user unit)	×	R	Page 376
SD5670	SD5710	SD5750	SD5790	SD5830	SD5870	SD5910	SD5950	Positioning error (error code)	×	R/W	Page 399
SD5676, SD5677	SD5716, SD5717	SD5756, SD5757	SD5796, SD5797	SD5836, SD5837	SD5876, SD5877	SD5916, SD5917	SD5956, SD5957	Maximum speed	○	R/W	Page 377
SD5678, SD5679	SD5718, SD5719	SD5758, SD5759	SD5798, SD5799	SD5838, SD5839	SD5878, SD5879	SD5918, SD5919	SD5958, SD5959	Bias speed	○	R/W	Page 377
SD5680	SD5720	SD5760	SD5800	SD5840	SD5880	SD5920	SD5960	Acceleration time	○	R/W	Page 378
SD5681	SD5721	SD5761	SD5801	SD5841	SD5881	SD5921	SD5961	Deceleration time	○	R/W	Page 378

R: Read only, R/W: Read/write, ○: Supported, ×: Not supported

\*1 Writing can be performed only by the HCMOV/DHCMOV instruction.

## Outline of operation

For each speed, refer to  Page 375 Items related to speed.

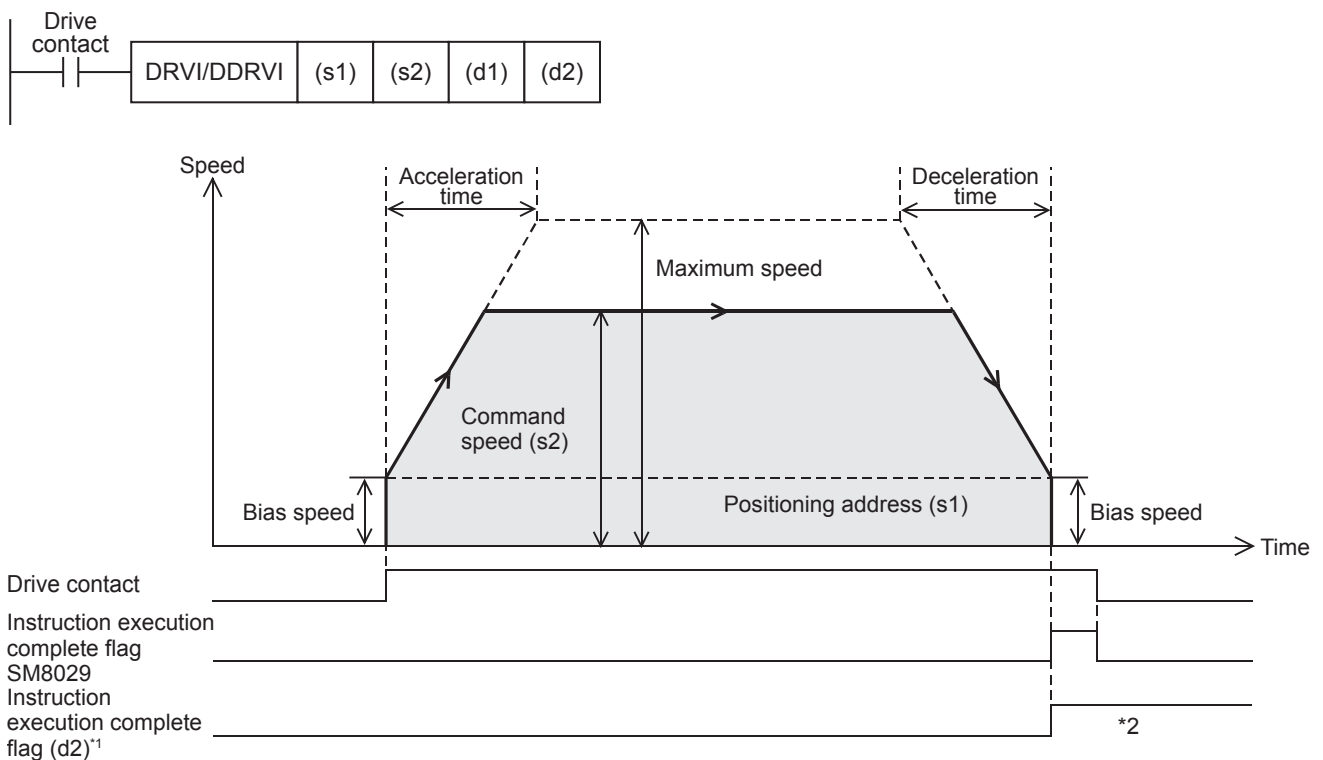

\*1 When FX5 operand is specified

\*2 Remains on until it is turned off using program or engineering tool or the positioning instruction is next driven again.

## Basic operation

The following describes the basic operation.

1. After the drive contact is turned on, pulse output is started and the speed is increased from the bias speed.
2. After the speed has reached the specified speed, the operation will be performed in the specified speed.
3. Deceleration starts from near the target position.
4. After movement to the specified positioning address, pulse output is stopped.

## Operand specification

### ■When FX5 operand is specified

**1.** For (s1), specify the relative positioning address. (☞ Page 378 Positioning address)

Set to a value -2147483648 to +2147483647 in pulse.

- DRVI: -32768 to +32767 (User system unit)
- DDRVI: -2147483648 to +2147483647 (User system unit)

**2.** For (s2), specify the command speed. Set to a value 1 pps to 200 kpps in pulse. For the FX5S CPU module, set to a value 1 to 100 kpps.

- DRVI: 1 to 65535 (User system unit)
- DDRVI: 1 to 2147483647 (User system unit)

**3.** For (d1), specify an axis number for which pulses are output.

Specify an axis number whose positioning parameters are set in the high speed I/O parameters. Operation cannot be performed if any other axis number is specified.

[FX5S CPU module]

- K1 to K4: Axis 1 to Axis 4

[FX5UJ CPU module]

- K1 to K3: Axis 1 to Axis 3 (CPU module)
- K5, K6: Axis 5, Axis 6 (High-speed pulse input/output module first module)
- K7, K8: Axis 7, Axis 8 (High-speed pulse input/output module second module)
- K9, K10: Axis 9, Axis 10 (High-speed pulse input/output module third module)
- K11, K12: Axis 11, Axis 12 (High-speed pulse input/output module fourth module)

[FX5U/FX5UC CPU module]

- K1 to K4: Axis 1 to Axis 4 (CPU module)
- K5, K6: Axis 5, Axis 6 (High-speed pulse input/output module first module)
- K7, K8: Axis 7, Axis 8 (High-speed pulse input/output module second module)
- K9, K10: Axis 9, Axis 10 (High-speed pulse input/output module third module)
- K11, K12: Axis 11, Axis 12 (High-speed pulse input/output module fourth module)

**4.** For (d2), specify the bit devices of the instruction execution complete flag and abnormal end flag. (☞ Page 400 Complete flag)

- (d2): Instruction execution complete flag
- (d2)+1: Instruction execution abnormal end flag

## ■When the FX3 compatible operand is specified (Supported only for CPU module)

1. For (s1), specify the relative positioning address.

Set to a value -2147483648 to +2147483647 in pulse.

- DRVI: -32768 to +32767 (User system unit)
- DDRVI: -2147483648 to +2147483647 (User system unit)

2. For (s2), specify the command speed. Set to a value 1 pps to 200 kpps in pulse. For the FX5S CPU module, set to a value 1 to 100 kpps.

- DRVI: 1 to 65535 (User system unit)
- DDRVI: 1 to 2147483647 (User system unit)

3. For (d1), specify the pulse output number.

Specify an output device (Y) number set in the high speed I/O parameters. (☞ Page 370 Pulse Output Mode) Operation cannot be performed if any other axis number is specified.

- FX5S/FX5U/FX5UC CPU module: Y0 to Y3 (equivalent to axes 1 to 4)
- FX5UJ CPU module: Y0 to Y2 (equivalent to axes 1 to 3)

4. For (d2), specify the rotation direction signal output device number. (☞ Page 372 Rotation Direction Setting)

When an output device (Y) is used, only the device that is specified with the positioning parameter or a general-purpose output can be specified. However, if an output device (Y) to which PWM, PULSE/SIGN axis of another axis, or CW/CCW axis is assigned is specified, an error occurs without any operation.

For the PWM function, refer to the following.

☞ Page 319 PWM Function

## Precautions

Set the number of output pulses per DRVI/DDRVI instruction execution to 2147483647 or lower. An error occurs if the number of pulses exceeds 2147483648.

## Operation of the complete flags

The following describes the operation timings of the complete flags.

The user-specified complete flags are valid only when specified using FX5 operand.

Item	FX3 compatible		User specification	
	Instruction execution complete flag (SM8029)	Instruction execution abnormal end flag (SM8329)	Instruction execution complete flag (d2)	Instruction execution abnormal end flag (d2)+1
ON condition	From when pulse output of the specified positioning address is completed to when the drive contact is turned off	From when the following operation or function is completed to when the drive contact is turned off <ul style="list-style-type: none"> <li>• The axis is already used.*1</li> <li>• Pulse output stop command</li> <li>• Pulse decelerate and stop command*2</li> <li>• Limit of the moving direction</li> <li>• All module reset when a stop error occurs*3</li> <li>• All outputs disabled (SM8034)</li> <li>• Positioning address error</li> <li>• Deceleration stop after the command speed is changed to 0</li> </ul>	From when pulse output of the specified positioning address is completed to when the ON → OFF condition is met	From when the following operation or function is completed to when the ON → OFF condition is met <ul style="list-style-type: none"> <li>• The axis is already used.</li> <li>• The drive contact is turned off during positioning operation.</li> <li>• Pulse output stop command</li> <li>• Pulse decelerate and stop command*2</li> <li>• Limit of the moving direction</li> <li>• All module reset when a stop error occurs*3</li> <li>• All outputs disabled (SM8034)</li> <li>• Online change</li> <li>• Positioning address error</li> <li>• Deceleration stop after the command speed is changed to 0</li> </ul>
ON → OFF condition	When the drive contact is turned off		The flag remains on until either of the following is performed. <ul style="list-style-type: none"> <li>• Turning off the flag by the user</li> <li>• Restarting the positioning instruction</li> </ul>	

\*1 The flag turns on only for one scan when the drive contact of the instruction turns from OFF to ON.

\*2 When remaining distance operation enabled is turned on, abnormal end flag will not turn on. (☞ Page 385 Remaining distance operation enabled)

\*3 Only high-speed pulse input/output module is supported.

# Program example

This program example shows a reversed operation that is performed by changing the positioning address at the current position + 70000 during relative positioning operation (axis 1).

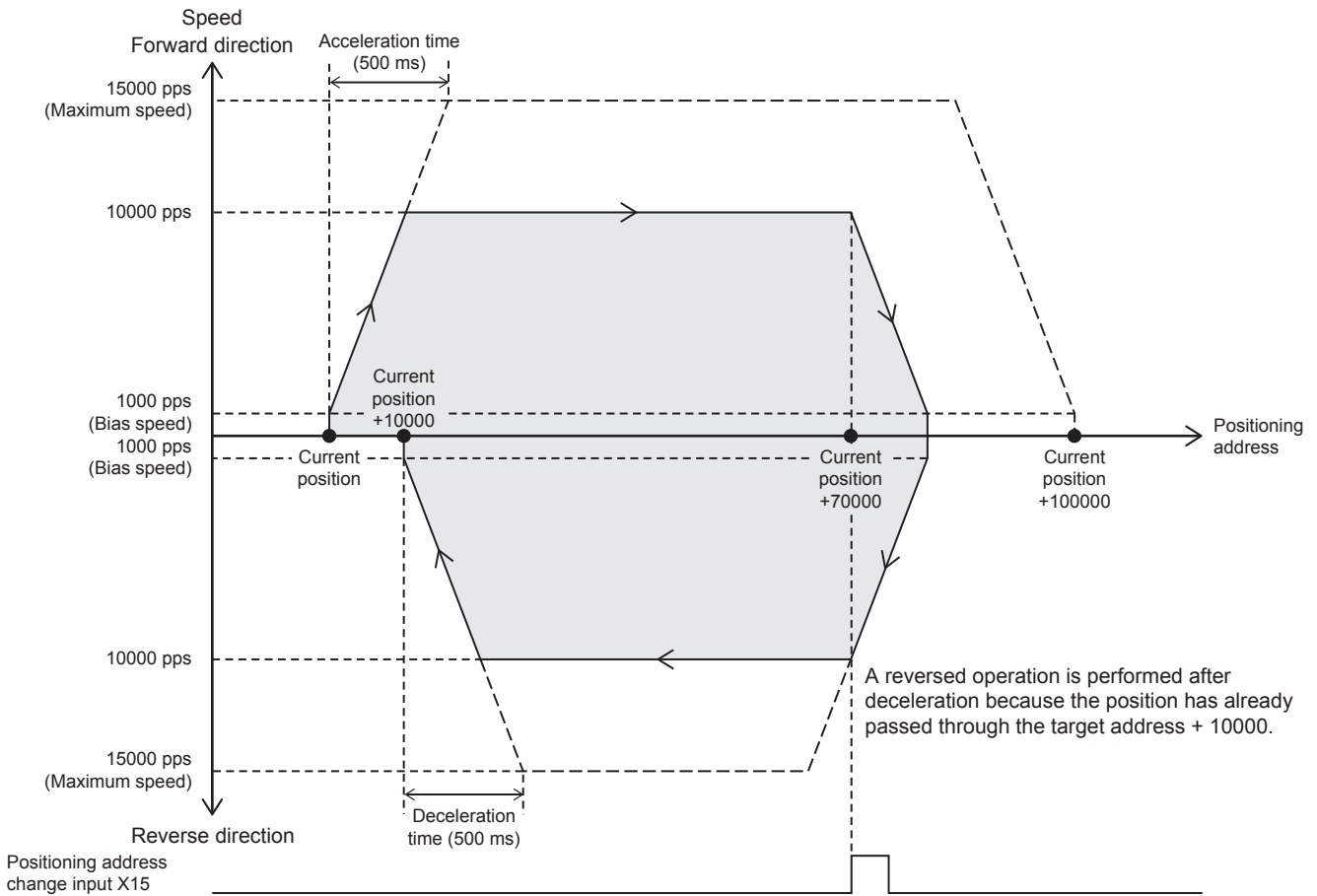

## Setting data

### ■Positioning parameter (high speed I/O parameter)

Item	Axis 1	Item	Axis 1
■Basic Parameter 1		■Basic Parameter 2	
Pulse Output Mode	1: PULSE/SIGN	Interpolation Speed Specified Method	0: Composite Speed
Output Device (PULSE/CW)	Y0	Max. Speed	15000 pps
Output Device (SIGN/CCW)	Y4	Bias Speed	1000 pps
Rotation Direction Setting	0: Current Address Increment with Forward Run Pulse Output	Acceleration Time	500 ms
Unit Setting	0: Motor System (pulse, pps)	Deceleration Time	500 ms
No. of Pulse per Rotation	2000 pulse	■Detailed Setting Parameter	
Movement Amount per Rotation	1000 pulse	External Start Signal Enabled/ Disabled	0: Disabled
Positioning Data Magnification	1: × Single	Interrupt Input Signal 1 Enabled/ Disabled	0: Disabled
—		Interrupt Input Signal 2 Logic	0: Positive Logic
		■OPR Parameter	
		OPR Enabled/Disabled	0: Disabled

## Program example

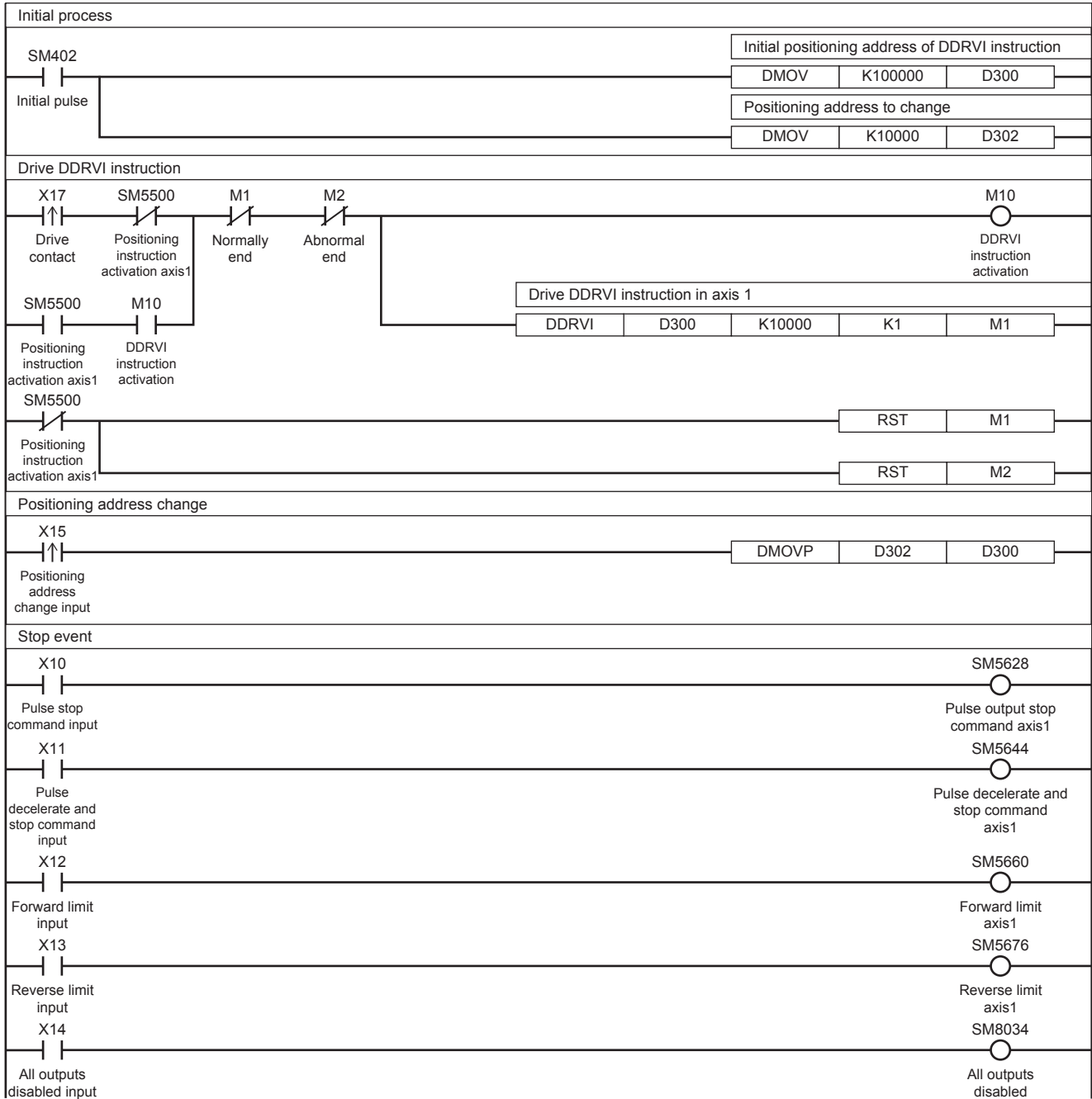



# 32.5 Absolute Positioning

This instruction performs 1-speed positioning in the absolute method (positioning operation with an absolute address). Specify the distance (absolute address) from the origin to the target position. In this case, any position can be the start point (current position).

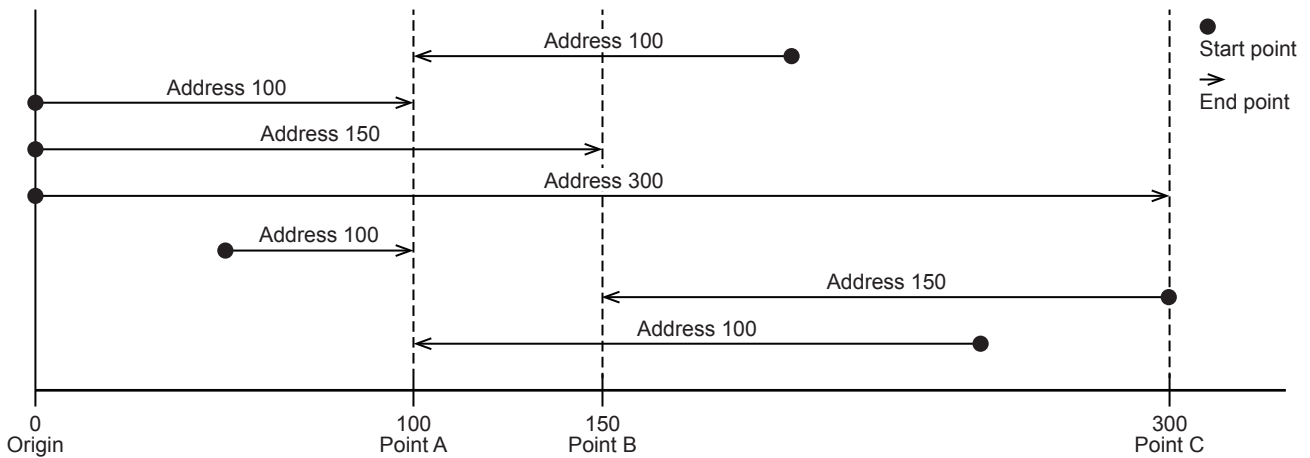

## DRVA/DDRVA

This instruction executes 1-speed positioning by absolute address.

Ladder	ST	FBD/LD
	ENO:=DRVA(EN,s1,s2,d1,d2); ENO:=DDRVA(EN,s1,s2,d1,d2);	

### Setting data

#### ■Description, range, data type (DRVA)

- FX5 operand

Operand	Description	Range	Data type	Data type (label)
(s1)	Word device number storing the positioning address or data <sup>1</sup>	-32768 to +32767 (User system unit)	16-bit signed binary	ANY16
(s2)	Word device number storing command speed or data <sup>2</sup>	1 to 65535 (User system unit)	16-bit unsigned binary	ANY16
(d1)	Axis number from which pulses are output	■FX5S CPU module K1 to K4 ■FX5UJ CPU module K1 to K3, K5 to K12 ■FX5U/FX5UC CPU module K1 to K12	16-bit unsigned binary	ANY_ELEMENTARY (WORD)
(d2)	Bit device number of the instruction execution complete flag and abnormal end flag	—	Bit	ANY_BOOL
EN	Execution condition	—	Bit	BOOL
ENO	Execution result	—	Bit	BOOL

- FX3 compatible operand (Supported only for CPU module)

Operand	Description	Range	Data type	Data type (label)
(s1)	Word device number storing the positioning address or data <sup>*1</sup>	-32768 to +32767 (User system unit)	16-bit signed binary	ANY16
(s2)	Word device number storing command speed or data <sup>*2</sup>	1 to 65535 (User system unit)	16-bit unsigned binary	ANY16
(d1)	Bit device number (Y) from which pulses are output	■FX5S/FX5U/FX5UC CPU module Y0 to Y3 ■FX5UJ CPU module Y0 to Y2	Bit	ANY_ELEMENTARY (BOOL)
(d2)	Bit device number from which rotation direction is output	—	Bit	ANY_BOOL
EN	Execution condition	—	Bit	BOOL
ENO	Execution result	—	Bit	BOOL

\*1 The positioning address can be changed during positioning operation. (Page 359 Positioning address change during positioning operation)

\*2 Command speed can be changed during positioning operation. (Page 360 Command speed change during positioning operation)

## ■Description, range, data type (DDRVA)

- FX5 operand

Operand	Description	Range	Data type	Data type (label)
(s1)	Word device number storing the positioning address or data <sup>*1</sup>	-2147483648 to +2147483647 (User system unit)	32-bit signed binary	ANY32
(s2)	Word device number storing command speed or data <sup>*2</sup>	1 to 2147483647 (User system unit)	32-bit signed binary	ANY32
(d1)	Axis number from which pulses are output	■FX5S CPU module K1 to K4 ■FX5UJ CPU module K1 to K3, K5 to K12 ■FX5U/FX5UC CPU module K1 to K12	16-bit unsigned binary	ANY_ELEMENTARY (WORD)
(d2)	Bit device number of the instruction execution complete flag and abnormal end flag	—	Bit	ANY_BOOL
EN	Execution condition	—	Bit	BOOL
ENO	Execution result	—	Bit	BOOL

- FX3 compatible operand (Supported only for CPU module)

Operand	Description	Range	Data type	Data type (label)
(s1)	Word device number storing the positioning address or data <sup>*1</sup>	-2147483648 to +2147483647 (User system unit)	32-bit signed binary	ANY32
(s2)	Word device number storing command speed or data <sup>*2</sup>	1 to 2147483647 (User system unit)	32-bit signed binary	ANY32
(d1)	Bit device number (Y) from which pulses are output	■FX5S/FX5U/FX5UC CPU module Y0 to Y3 ■FX5UJ CPU module Y0 to Y2	Bit	ANY_ELEMENTARY (BOOL)
(d2)	Bit device number from which rotation direction is output	—	Bit	ANY_BOOL
EN	Execution condition	—	Bit	BOOL
ENO	Execution result	—	Bit	BOOL

\*1 The positioning address can be changed during positioning operation.

\*2 Command speed can be changed during positioning operation.

## Available device (DRVA/DDRVA)

- FX5 operand

Operand	Bit	Word			Double word		Indirect specification	Constant			Others
	X, Y, M, L, SM, F, B, SB, S	T, ST, C, D, W, SD, SW, R	U□\G□	Z	LC	LZ		K, H	E	\$	
(s1)	○	○	○	○	○ <sup>*1</sup>	○ <sup>*1</sup>	○	○	—	—	—
(s2)	○	○	○	○	○ <sup>*1</sup>	○ <sup>*1</sup>	○	○	—	—	—
(d1)	—	○	○	○	—	—	○	○	—	—	—
(d2) <sup>*2</sup>	○	○ <sup>*3</sup>	—	—	—	—	—	—	—	—	—

- FX3 compatible operand (Supported only for CPU module)

Operand	Bit	Word			Double word		Indirect specification	Constant			Others
	X, Y, M, L, SM, F, B, SB, S	T, ST, C, D, W, SD, SW, R	U□\G□	Z	LC	LZ		K, H	E	\$	
(s1)	○	○	○	○	○ <sup>*1</sup>	○ <sup>*1</sup>	○	○	—	—	—
(s2)	○	○	○	○	○ <sup>*1</sup>	○ <sup>*1</sup>	○	○	—	—	—
(d1)	○ <sup>*4</sup>	—	—	—	—	—	—	—	—	—	—
(d2)	○ <sup>*4</sup>	○ <sup>*3</sup>	—	—	—	—	—	—	—	—	—

\*1 Only available for DDRVA instruction.

\*2 Two devices are occupied from the specified device.

\*3 T, ST, C cannot be used.

\*4 FX5S/FX5U/FX5UC CPU module: Only Y0 to Y3 devices can be used.  
FX5UJ CPU module: Only Y0 to Y2 devices can be used.

\*5 When the output mode is CW/CCW, specify the CCW axis. When the output mode is PULSE/SIGN, only the SIGN output of the axis or general-purpose output can be specified.

## Processing details

This instruction executes 1-speed positioning by absolute address drive. The target positioning address is specified in the absolute method, in which positioning is performed with the target position specified based on the origin (absolute address).

## Related devices

The following lists the related special devices.

Related devices of axis 4 are available only for the FX5S/FX5U/FX5UC CPU module.

### Special relays

#### ■CPU module

FX5 dedicated				FX3 compatible				Name	High Speed I/O Parameter	R/W	Reference
Axis 1	Axis 2	Axis 3	Axis 4	Axis 1	Axis 2	Axis 3	Axis 4				
—	—	—	—	SM8029				Instruction execution complete flag	×	R	Page 400
—	—	—	—	SM8329				Instruction execution abnormal end flag	×	R	
SM5500	SM5501	SM5502	SM5503	SM8348	SM8358	SM8368	SM8378	Positioning instruction activation	×	R	Page 398
SM5516	SM5517	SM5518	SM5519	SM8340	SM8350	SM8360	SM8370	Pulse output monitor	×	R	Page 398
SM5532	SM5533	SM5534	SM5535	—	—	—	—	Positioning error occurrence	×	R/W	Page 398
SM5596	SM5597	SM5598	SM5599	—	—	—	—	Remaining distance operation enabled	×	R/W	Page 385
SM5612	SM5613	SM5614	SM5615	—	—	—	—	Remaining distance operation start	×	R/W	Page 385
SM5628	SM5629	SM5630	SM5631	—	—	—	—	Pulse output stop command	×	R/W	Page 382
SM5644	SM5645	SM5646	SM5647	—	—	—	—	Pulse decelerate and stop command	×	R/W	Page 383
SM5660	SM5661	SM5662	SM5663	—	—	—	—	Forward limit	×	R/W	Page 384
SM5676	SM5677	SM5678	SM5679	—	—	—	—	Reverse limit	×	R/W	Page 384
SM5772	SM5773	SM5774	SM5775	—	—	—	—	Rotation direction setting	○	R/W	Page 372

R: Read only, R/W: Read/write, ○: Supported, ×: Not supported

#### ■High-speed pulse input/output module

First module		Second module		Third module		Fourth module		Name	High Speed I/O Parameter	R/W	Reference
Axis 5	Axis 6	Axis 7	Axis 8	Axis 9	Axis 10	Axis 11	Axis 12				
SM8029 (FX3 compatible device)								Instruction execution complete flag	×	R	Page 400
SM8329 (FX3 compatible device)								Instruction execution abnormal end flag	×	R	
SM5504	SM5505	SM5506	SM5507	SM5508	SM5509	SM5510	SM5511	Positioning instruction activation	×	R	Page 398
SM5520	SM5521	SM5522	SM5523	SM5524	SM5525	SM5526	SM5527	Pulse output monitor	×	R	Page 398
SM5536	SM5537	SM5538	SM5539	SM5540	SM5541	SM5542	SM5543	Positioning error occurrence	×	R/W	Page 398
SM5600	SM5601	SM5602	SM5603	SM5604	SM5605	SM5606	SM5607	Remaining distance operation enabled	×	R/W	Page 385
SM5616	SM5617	SM5618	SM5619	SM5620	SM5621	SM5622	SM5623	Remaining distance operation start	×	R/W	Page 385
SM5632	SM5633	SM5634	SM5635	SM5636	SM5637	SM5638	SM5639	Pulse output stop command	×	R/W	Page 382
SM5648	SM5649	SM5650	SM5651	SM5652	SM5653	SM5654	SM5655	Pulse decelerate and stop command	×	R/W	Page 383
SM5664	SM5665	SM5666	SM5667	SM5668	SM5669	SM5670	SM5671	Forward limit	×	R/W	Page 384
SM5680	SM5681	SM5682	SM5683	SM5684	SM5685	SM5686	SM5687	Reverse limit	×	R/W	Page 384
SM5776	SM5777	SM5778	SM5779	SM5780	SM5781	SM5782	SM5783	Rotation direction setting	○	R/W	Page 372

R: Read only, R/W: Read/write, ○: Supported, ×: Not supported

## Special registers

### ■CPU module

FX5 dedicated				FX3 compatible				Name	High Speed I/O Parameter	R/W	Reference
Axis 1	Axis 2	Axis 3	Axis 4	Axis 1	Axis 2	Axis 3	Axis 4				
SD5500, SD5501	SD5540, SD5541	SD5580, SD5581	SD5620, SD5621	—	—	—	—	Current address (user unit)	×	R/W*1	Page 380
SD5502, SD5503	SD5542, SD5543	SD5582, SD5583	SD5622, SD5623	SD8340, SD8341	SD8350, SD8351	SD8360, SD8361	SD8370, SD8371	Current address (pulse unit)	×	R/W*1	Page 380
SD5504, SD5505	SD5544, SD5545	SD5584, SD5585	SD5624, SD5625	—	—	—	—	Current speed (user unit)	×	R	Page 376
SD5510	SD5550	SD5590	SD5630	—	—	—	—	Positioning error (error code)	×	R/W	Page 399
SD5516, SD5517	SD5556, SD5557	SD5596, SD5597	SD5636, SD5637	—	—	—	—	Maximum speed	○	R/W	Page 377
SD5518, SD5519	SD5558, SD5559	SD5598, SD5599	SD5638, SD5639	—	—	—	—	Bias speed	○	R/W	Page 377
SD5520	SD5560	SD5600	SD5640	—	—	—	—	Acceleration time	○	R/W	Page 378
SD5521	SD5561	SD5601	SD5641	—	—	—	—	Deceleration time	○	R/W	Page 378

R: Read only, R/W: Read/write, ○: Supported, ×: Not supported

\*1 Only FX5 dedicated devices can be written by the HCMOV/DHCMOV instruction.

### ■High-speed pulse input/output module

First module		Second module		Third module		Fourth module		Name	High Speed I/O Parameter	R/W	Reference
Axis 5	Axis 6	Axis 7	Axis 8	Axis 9	Axis 10	Axis 11	Axis 12				
SD5660, SD5661	SD5700, SD5701	SD5740, SD5741	SD5780, SD5781	SD5820, SD5821	SD5860, SD5861	SD5900, SD5901	SD5940, SD5941	Current address (user unit)	×	R/W*1	Page 380
SD5662, SD5663	SD5702, SD5703	SD5742, SD5743	SD5782, SD5783	SD5822, SD5823	SD5862, SD5863	SD5902, SD5903	SD5942, SD5943	Current address (pulse unit)	×	R/W*1	Page 380
SD5664, SD5665	SD5704, SD5705	SD5744, SD5745	SD5784, SD5785	SD5824, SD5825	SD5864, SD5865	SD5904, SD5905	SD5944, SD5945	Current speed (user unit)	×	R	Page 376
SD5670	SD5710	SD5750	SD5790	SD5830	SD5870	SD5910	SD5950	Positioning error (error code)	×	R/W	Page 399
SD5676, SD5677	SD5716, SD5717	SD5756, SD5757	SD5796, SD5797	SD5836, SD5837	SD5876, SD5877	SD5916, SD5917	SD5956, SD5957	Maximum speed	○	R/W	Page 377
SD5678, SD5679	SD5718, SD5719	SD5758, SD5759	SD5798, SD5799	SD5838, SD5839	SD5878, SD5879	SD5918, SD5919	SD5958, SD5959	Bias speed	○	R/W	Page 377
SD5680	SD5720	SD5760	SD5800	SD5840	SD5880	SD5920	SD5960	Acceleration time	○	R/W	Page 378
SD5681	SD5721	SD5761	SD5801	SD5841	SD5881	SD5921	SD5961	Deceleration time	○	R/W	Page 378

R: Read only, R/W: Read/write, ○: Supported, ×: Not supported

\*1 Writing can be performed only by the HCMOV/DHCMOV instruction.

# Outline of operation

For each speed, refer to [Page 375](#) Items related to speed.

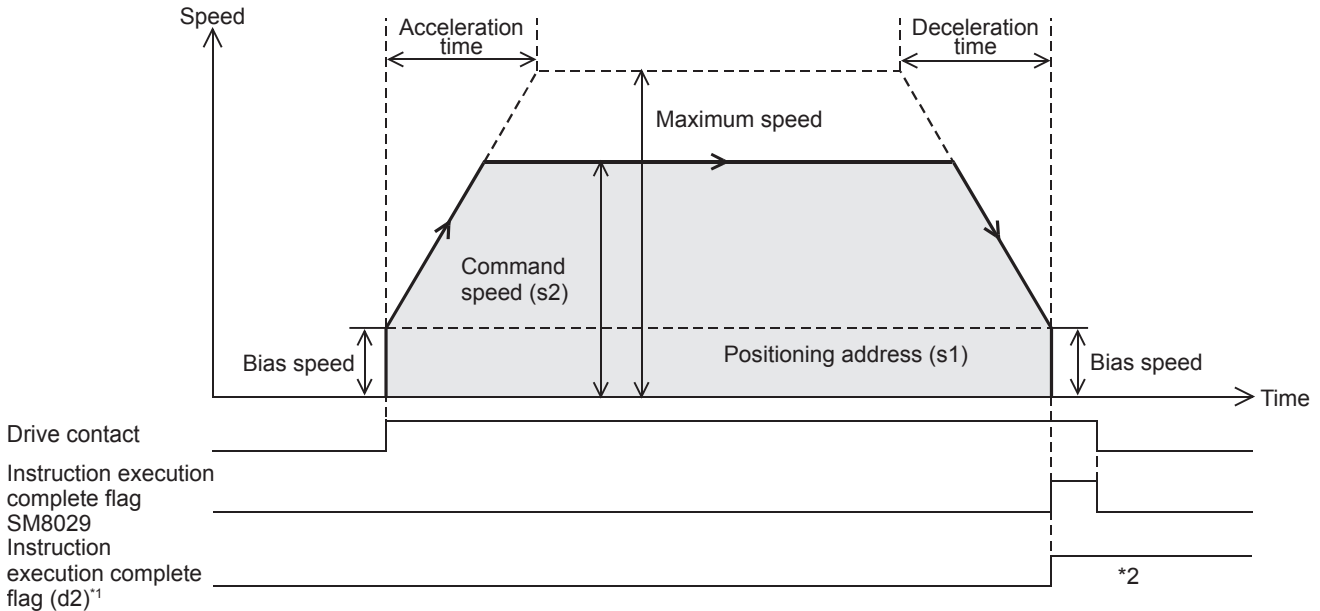
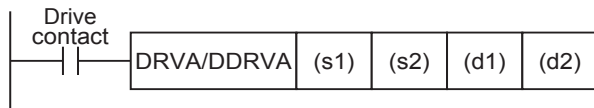

\*1 When FX5 operand is specified

\*2 Remains on until it is turned off using program or engineering tool or the positioning instruction is next driven again.

## Basic operation

The following describes the basic operation.

1. After the drive contact is turned on, pulse output is started and the speed is increased from the bias speed.
2. After the speed has reached the specified speed, the operation will be performed in the specified speed.
3. Deceleration starts from near the target position.
4. At the specified positioning address, pulse output is stopped.

## Operand specification

### ■When FX5 operand is specified

1. For (s1), specify the absolute positioning address. ([Page 378](#) Positioning address)

Set to a value -2147483648 to +2147483647 in pulse. In addition, set the number of output pulses per positioning instruction execution to 2147483647 or lower.

- DRVA: -32768 to +32767 (User system unit)
- DDRVA: -2147483648 to +2147483647 (User system unit)

2. For (s2), specify the command speed. Set to a value 1 pps to 200 kpps in pulse. For the FX5S CPU module, set to a value 1 to 100 kpps.

- DRVA: 1 to 65535 (User system unit)
- DDRVA: 1 to 2147483647 (User system unit)

**3.** For (d1), specify an axis number for which pulses are output.

Specify an axis number whose positioning parameters are set in the high speed I/O parameters. Operation cannot be performed if any other axis number is specified.

[FX5S CPU module]

- K1 to K4: Axis 1 to Axis 4

[FX5UJ CPU module]

- K1 to K3: Axis 1 to Axis 3 (CPU module)
- K5, K6: Axis 5, Axis 6 (High-speed pulse input/output module first module)
- K7, K8: Axis 7, Axis 8 (High-speed pulse input/output module second module)
- K9, K10: Axis 9, Axis 10 (High-speed pulse input/output module third module)
- K11, K12: Axis 11, Axis 12 (High-speed pulse input/output module fourth module)

[FX5U/FX5UC CPU module]

- K1 to K4: Axis 1 to Axis 4 (CPU module)
- K5, K6: Axis 5, Axis 6 (High-speed pulse input/output module first module)
- K7, K8: Axis 7, Axis 8 (High-speed pulse input/output module second module)
- K9, K10: Axis 9, Axis 10 (High-speed pulse input/output module third module)
- K11, K12: Axis 11, Axis 12 (High-speed pulse input/output module fourth module)

**4.** For (d2), specify the bit devices of the instruction execution complete flag and abnormal end flag. (☞ Page 400 Complete flag)

- (d2): Instruction execution complete flag
- (d2)+1: Instruction execution abnormal end flag

### ■When the FX3 compatible operand is specified (Supported only for CPU module)

**1.** For (s1), specify the absolute positioning address.

Set to a value -2147483648 to +2147483647 in pulse. In addition, set the number of output pulses per positioning instruction execution to 2147483647 or lower.

- DRVA: -32768 to +32767 (User system unit)
- DDRVA: -2147483648 to +2147483647 (User system unit)

**2.** For (s2), specify the command speed. Set to a value 1 pps to 200 kpps in pulse. For the FX5S CPU module, set to a value 1 to 100 kpps.

- DRVA: 1 to 65535 (User system unit)
- DDRVA: 1 to 2147483647 (User system unit)

**3.** For (d1), specify the pulse output number.

Specify an output device (Y) number set in the high speed I/O parameters. (☞ Page 370 Pulse Output Mode) Operation cannot be performed if any other axis number is specified.

- FX5S/FX5U/FX5UC CPU module: Y0 to Y3 (equivalent to axes 1 to 4)
- FX5UJ CPU module: Y0 to Y2 (equivalent to axes 1 to 3)

**4.** For (d2), specify the rotation direction signal output device number. (☞ Page 372 Rotation Direction Setting)

When an output device (Y) is used, only the device that is specified with the positioning parameter or a general-purpose output can be specified. However, if an output device (Y) to which PWM, PULSE/SIGN axis of another axis, or CW/CCW axis is assigned is specified, an error occurs without any operation.

For the PWM function, refer to the following.

☞ Page 319 PWM Function

## Precautions

Set the number of output pulses per DRVA/DDRVA instruction execution to 2147483647 or lower. An error occurs if the number of pulses exceeds 2147483648.

## Operation of the abnormal end flag

The following describes the operation timings of the complete flags.

The user-specified complete flags are valid only when specified using FX5 operand.

Item	FX3 compatible		User specification	
	Instruction execution complete flag (SM8029)	Instruction execution abnormal end flag (SM8329)	Instruction execution complete flag (d2)	Instruction execution abnormal end flag (d2)+1
ON condition	From when pulse output of the specified positioning address is completed to when the drive contact is turned off	From when the following operation or function is completed to when the drive contact is turned off <ul style="list-style-type: none"> <li>• The axis is already used.*1</li> <li>• Pulse output stop command</li> <li>• Pulse decelerate and stop command*2</li> <li>• Limit of the moving direction</li> <li>• All module reset when a stop error occurs*3</li> <li>• All outputs disabled (SM8034)</li> <li>• Positioning address error</li> <li>• Deceleration stop after the command speed is changed to 0</li> </ul>	From when pulse output of the specified positioning address is completed to when the ON → OFF condition is met	From when the following operation or function is completed to when the ON → OFF condition is met <ul style="list-style-type: none"> <li>• The axis is already used.</li> <li>• The drive contact is turned off during positioning operation.</li> <li>• Pulse output stop command</li> <li>• Pulse decelerate and stop command*2</li> <li>• Limit of the moving direction</li> <li>• All module reset when a stop error occurs*3</li> <li>• All outputs disabled (SM8034)</li> <li>• Online change</li> <li>• Positioning address error</li> <li>• Deceleration stop after the command speed is changed to 0</li> </ul>
ON → OFF condition	When the drive contact is turned off		The flag remains on until either of the following is performed. <ul style="list-style-type: none"> <li>• Turning off the flag by the user</li> <li>• Restarting the positioning instruction</li> </ul>	

\*1 The flag turns on only for one scan when the drive contact of the instruction turns from OFF to ON.

\*2 When remaining distance operation enabled is turned on, abnormal end flag will not turn on. (Page 385 Remaining distance operation enabled)

\*3 Only high-speed pulse input/output module is supported.

## Program example

The following is a program example of absolute positioning (axis 1). If current address is a positive value, positioning operation would output in the reverse direction.

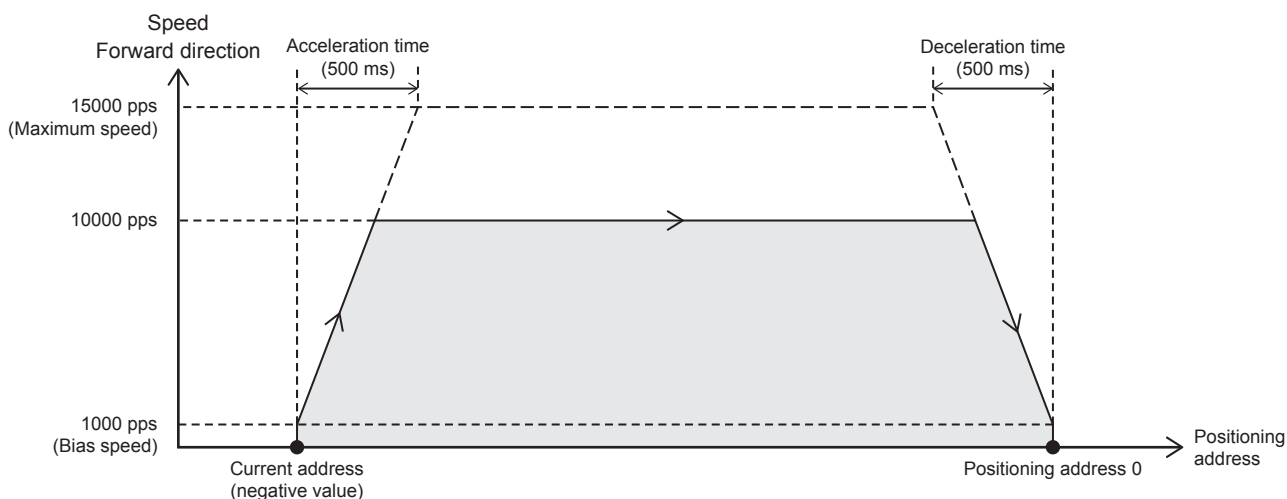



## Setting data

### Positioning parameter (high speed I/O parameter)

Item	Axis 1	Item	Axis 1
■Basic Parameter 1		■Basic Parameter 2	
Pulse Output Mode	1: PULSE/SIGN	Interpolation Speed Specified Method	0: Composite Speed
Output Device (PULSE/CW)	Y0	Max. Speed	15000 pps
Output Device (SIGN/CCW)	Y4	Bias Speed	1000 pps
Rotation Direction Setting	0: Current Address Increment with Forward Run Pulse Output	Acceleration Time	500 ms
Unit Setting	0: Motor System (pulse, pps)	Deceleration Time	500 ms
No. of Pulse per Rotation	2000 pulse	■Detailed Setting Parameter	
Movement Amount per Rotation	1000 pulse	External Start Signal Enabled/Disabled	0: Disabled
Positioning Data Magnification	1: × Single	Interrupt Input Signal 1 Enabled/Disabled	0: Disabled
—		Interrupt Input Signal 2 Logic	0: Positive Logic
		■OPR Parameter	
		OPR Enabled/Disabled	0: Disabled

## Program example

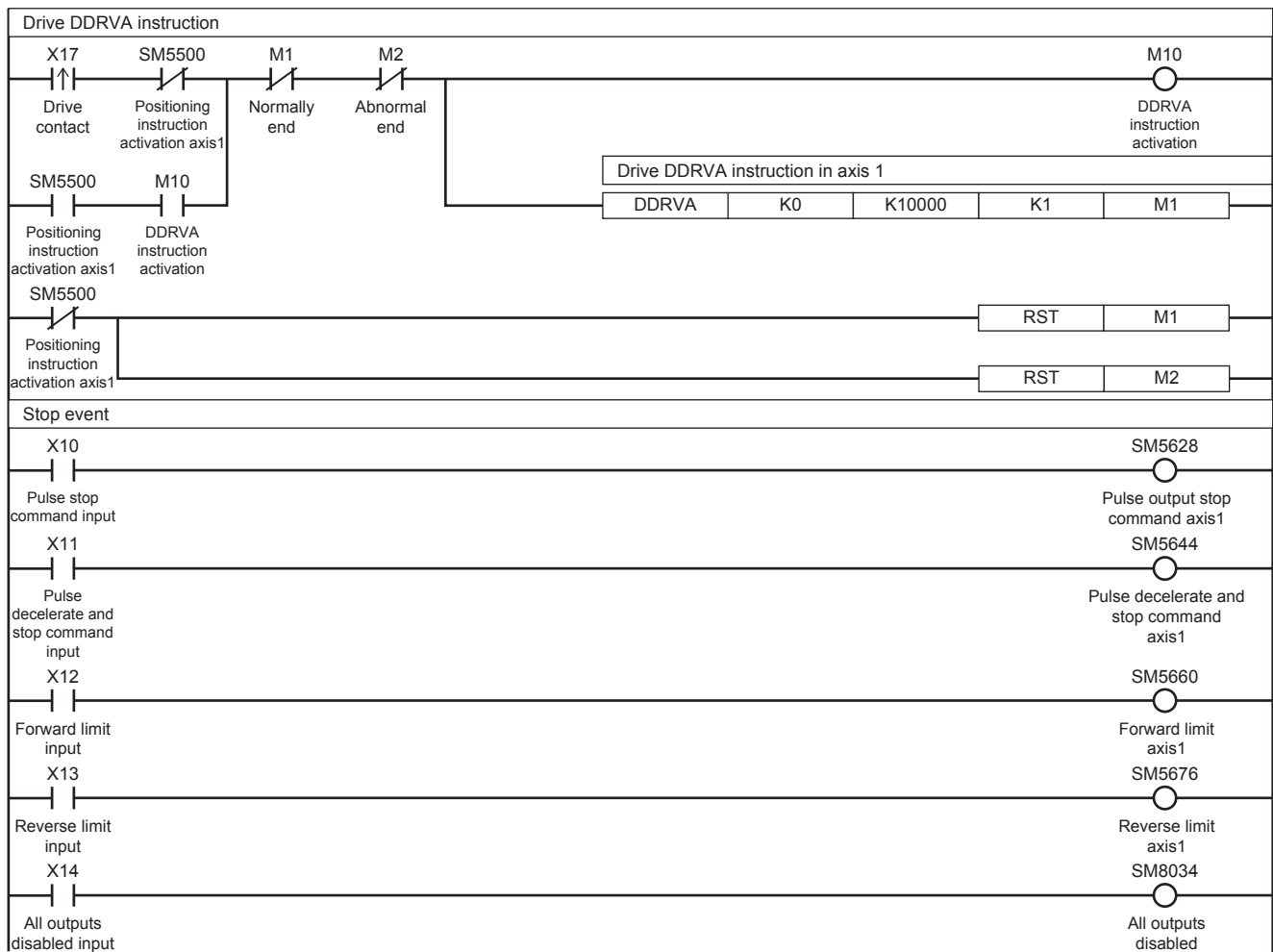

## 32.6 Interrupt 1-Speed Positioning

The positioning function uses the DVIT/DDVIT instruction to perform one-speed interrupt constant quantity feed. With this instruction, interrupt signals can be controlled through user programs.

### DVIT/DDVIT

This instruction executes one-speed interrupt constant quantity feed.

Ladder	ST	FBD/LD
	ENO:=DVIT(EN,s1,s2,d1,d2); ENO:=DDVIT(EN,s1,s2,d1,d2);	

### Setting data

#### ■Description, range, data type (DVIT)

- FX5 operand

Operand	Description	Range	Data type	Data type (label)
(s1)	Word device number storing the positioning address or data <sup>*1</sup>	-32768 to +32767 (User system unit)	16-bit signed binary	ANY16
(s2)	Word device number storing command speed or data <sup>*2</sup>	1 to 65535 (User system unit)	16-bit unsigned binary	ANY16
(d1)	Axis number from which pulses are output	■FX5S CPU module K1 to K4 ■FX5UJ CPU module K1 to K3, K5 to K12 ■FX5U/FX5UC CPU module K1 to K12	16-bit unsigned binary	ANY_ELEMENTARY (WORD)
(d2)	Bit device number of the instruction execution complete flag and abnormal end flag	—	Bit	ANY_BOOL
EN	Execution condition	—	Bit	BOOL
ENO	Execution result	—	Bit	BOOL

- FX3 compatible operand (Supported only for CPU module)

Operand	Description	Range	Data type	Data type (label)
(s1)	Word device number storing the positioning address or data <sup>*1</sup>	-32768 to +32767 (User system unit)	16-bit signed binary	ANY16
(s2)	Word device number storing command speed or data <sup>*2</sup>	1 to 65535 (User system unit)	16-bit unsigned binary	ANY16
(d1)	Bit device number (Y) from which pulses are output	■FX5S/FX5U/FX5UC CPU module Y0 to Y3 ■FX5UJ CPU module Y0 to Y2	Bit	ANY_ELEMENTARY (BOOL)
(d2)	Bit device number from which rotation direction is output	—	Bit	ANY_BOOL
EN	Execution condition	—	Bit	BOOL
ENO	Execution result	—	Bit	BOOL

\*1 The positioning address can be changed during positioning operation. (Page 359 Positioning address change during positioning operation)

\*2 Command speed can be changed during positioning operation. (Page 360 Command speed change during positioning operation)

## ■Description, range, data type (DDVIT)

• FX5 operand

Operand	Description	Range	Data type	Data type (label)
(s1)	Word device number storing the positioning address or data <sup>*1</sup>	-2147483648 to +2147483647 (User system unit)	32-bit signed binary	ANY32
(s2)	Word device number storing command speed or data <sup>*2</sup>	1 to 2147483647 (User system unit)	32-bit signed binary	ANY32
(d1)	Axis number from which pulses are output	■FX5S CPU module K1 to K4 ■FX5UJ CPU module K1 to K3, K5 to K12 ■FX5U/FX5UC CPU module K1 to K12	16-bit unsigned binary	ANY_ELEMENTARY (WORD)
(d2)	Bit device number of the instruction execution complete flag and abnormal end flag	—	Bit	ANY_BOOL
EN	Execution condition	—	Bit	BOOL
ENO	Execution result	—	Bit	BOOL

• FX3 compatible operand (Supported only for CPU module)

Operand	Description	Range	Data type	Data type (label)
(s1)	Word device number storing the positioning address or data <sup>*1</sup>	-2147483648 to +2147483647 (User system unit)	32-bit signed binary	ANY32
(s2)	Word device number storing command speed or data <sup>*2</sup>	1 to 2147483647 (User system unit)	32-bit signed binary	ANY32
(d1)	Bit device number (Y) from which pulses are output	■FX5S/FX5U/FX5UC CPU module Y0 to Y3 ■FX5UJ CPU module Y0 to Y2	Bit	ANY_ELEMENTARY (BOOL)
(d2)	Bit device number from which rotation direction is output	—	Bit	ANY_BOOL
EN	Execution condition	—	Bit	BOOL
ENO	Execution result	—	Bit	BOOL

\*1 The positioning address can be changed during positioning operation.

\*2 Command speed can be changed during positioning operation.

## ■Available device (DVIT/DDVIT)

• FX5 operand

Operand	Bit	Word			Double word		Indirect specification	Constant			Others
	X, Y, M, L, SM, F, B, SB, S	T, ST, C, D, W, SD, SW, R	U□\G□	Z	LC	LZ		K, H	E	\$	
(s1)	○	○	○	○	—	—	○	○	—	—	—
(s2)	○	○	○	○	—	—	○	○	—	—	—
(d1)	—	○	○	○	—	—	○	○	—	—	—
(d2) <sup>*1</sup>	○	○ <sup>*2</sup>	—	—	—	—	—	—	—	—	—

- FX3 compatible operand (Supported only for CPU module)

Operand	Bit	Word			Double word		Indirect specification	Constant			Others
	X, Y, M, L, SM, F, B, SB, S	T, ST, C, D, W, SD, SW, R	U□\G□	Z	LC	LZ		K, H	E	\$	
(s1)	○	○	○	○	—	—	○	○	—	—	—
(s2)	○	○	○	○	—	—	○	○	—	—	—
(d1)	○ <sup>*3</sup>	—	—	—	—	—	—	—	—	—	—
(d2)	○ <sup>*4</sup>	○ <sup>*2</sup>	—	—	—	—	—	—	—	—	—

\*1 Two devices are occupied from the specified device.

\*2 T, ST, C cannot be used.

\*3 FX5S/FX5U/FX5UC CPU module: Only Y0 to Y3 devices can be used.  
FX5UJ CPU module: Only Y0 to Y2 devices can be used.

\*4 When the output mode is CW/CCW, specify the CCW axis. When the output mode is PULSE/SIGN, only the SIGN output of the axis or general-purpose output can be specified.

## Processing details

This instruction executes one-speed interrupt constant quantity feed. From the point at which an interrupt input is detected, operation to the specified positioning address is performed at the specified speed.

## Related devices

The following lists the related special devices.

Related devices of axis 4 are available only for the FX5S/FX5U/FX5UC CPU module.

## Special relays

### ■CPU module

FX5 dedicated				FX3 compatible				Name	High Speed I/O Parameter	R/W	Reference
Axis 1	Axis 2	Axis 3	Axis 4	Axis 1	Axis 2	Axis 3	Axis 4				
—	—	—	—	SM8029				Instruction execution complete flag	×	R	Page 400
—	—	—	—	SM8329				Instruction execution abnormal end flag	×	R	
SM5500	SM5501	SM5502	SM5503	SM8348	SM8358	SM8368	SM8378	Positioning instruction activation	×	R	Page 398
SM5516	SM5517	SM5518	SM5519	SM8340	SM8350	SM8360	SM8370	Pulse output monitor	×	R	Page 398
SM5532	SM5533	SM5534	SM5535	—	—	—	—	Positioning error occurrence	×	R/W	Page 398
SM5628	SM5629	SM5630	SM5631	—	—	—	—	Pulse output stop command	×	R/W	Page 382
SM5644	SM5645	SM5646	SM5647	—	—	—	—	Pulse decelerate and stop command	×	R/W	Page 383
SM5660	SM5661	SM5662	SM5663	—	—	—	—	Forward limit	×	R/W	Page 384
SM5676	SM5677	SM5678	SM5679	—	—	—	—	Reverse limit	×	R/W	Page 384
SM5772	SM5773	SM5774	SM5775	—	—	—	—	Rotation direction setting	○	R/W	Page 372

R: Read only, R/W: Read/write, ○: Supported, ×: Not supported

## High-speed pulse input/output module

First module		Second module		Third module		Fourth module		Name	High Speed I/O Parameter	R/W	Reference
Axis 5	Axis 6	Axis 7	Axis 8	Axis 9	Axis 10	Axis 11	Axis 12				
SM8029 (FX3 compatible device)								Instruction execution complete flag	×	R	Page 400
SM8329 (FX3 compatible device)								Instruction execution abnormal end flag	×	R	
SM5504	SM5505	SM5506	SM5507	SM5508	SM5509	SM5510	SM5511	Positioning instruction activation	×	R	Page 398
SM5520	SM5521	SM5522	SM5523	SM5524	SM5525	SM5526	SM5527	Pulse output monitor	×	R	Page 398
SM5536	SM5537	SM5538	SM5539	SM5540	SM5541	SM5542	SM5543	Positioning error occurrence	×	R/W	Page 398
SM5632	SM5633	SM5634	SM5635	SM5636	SM5637	SM5638	SM5639	Pulse output stop command	×	R/W	Page 382
SM5648	SM5649	SM5650	SM5651	SM5652	SM5653	SM5654	SM5655	Pulse decelerate and stop command	×	R/W	Page 383
SM5664	SM5665	SM5666	SM5667	SM5668	SM5669	SM5670	SM5671	Forward limit	×	R/W	Page 384
SM5680	SM5681	SM5682	SM5683	SM5684	SM5685	SM5686	SM5687	Reverse limit	×	R/W	Page 384
SM5776	SM5777	SM5778	SM5779	SM5780	SM5781	SM5782	SM5783	Rotation direction setting	○	R/W	Page 372

R: Read only, R/W: Read/write, ○: Supported, ×: Not supported

## Special registers

### CPU module

FX5 dedicated				FX3 compatible				Name	High Speed I/O Parameter	R/W	Reference
Axis 1	Axis 2	Axis 3	Axis 4	Axis 1	Axis 2	Axis 3	Axis 4				
SD5500, SD5501	SD5540, SD5541	SD5580, SD5581	SD5620, SD5621	—	—	—	—	Current address (user unit)	×	R/W*1	Page 380
SD5502, SD5503	SD5542, SD5543	SD5582, SD5583	SD5622, SD5623	SD8340, SD8341	SD8350, SD8351	SD8360, SD8361	SD8370, SD8371	Current address (pulse unit)	×	R/W*1	Page 380
SD5504, SD5505	SD5544, SD5545	SD5584, SD5585	SD5624, SD5625	—	—	—	—	Current speed (user unit)	×	R	Page 376
SD5510	SD5550	SD5590	SD5630	—	—	—	—	Positioning error (error code)	×	R/W	Page 399
SD5516, SD5517	SD5556, SD5557	SD5596, SD5597	SD5636, SD5637	—	—	—	—	Maximum speed	○	R/W	Page 377
SD5518, SD5519	SD5558, SD5559	SD5598, SD5599	SD5638, SD5639	—	—	—	—	Bias speed	○	R/W	Page 377
SD5520	SD5560	SD5600	SD5640	—	—	—	—	Acceleration time	○	R/W	Page 378
SD5521	SD5561	SD5601	SD5641	—	—	—	—	Deceleration time	○	R/W	Page 378

R: Read only, R/W: Read/write, ○: Supported, ×: Not supported

\*1 Only FX5 dedicated devices can be written by the HCMOV/DHCMOV instruction.

## High-speed pulse input/output module

First module		Second module		Third module		Fourth module		Name	High Speed I/O Parameter	R/W	Reference
Axis 5	Axis 6	Axis 7	Axis 8	Axis 9	Axis 10	Axis 11	Axis 12				
SD5660, SD5661	SD5700, SD5701	SD5740, SD5741	SD5780, SD5781	SD5820, SD5821	SD5860, SD5861	SD5900, SD5901	SD5940, SD5941	Current address (user unit)	×	R/W <sup>*1</sup>	Page 380
SD5662, SD5663	SD5702, SD5703	SD5742, SD5743	SD5782, SD5783	SD5822, SD5823	SD5862, SD5863	SD5902, SD5903	SD5942, SD5943	Current address (pulse unit)	×	R/W <sup>*1</sup>	Page 380
SD5664, SD5665	SD5704, SD5705	SD5744, SD5745	SD5784, SD5785	SD5824, SD5825	SD5864, SD5865	SD5904, SD5905	SD5944, SD5945	Current speed (user unit)	×	R	Page 376
SD5670	SD5710	SD5750	SD5790	SD5830	SD5870	SD5910	SD5950	Positioning error (error code)	×	R/W	Page 399
SD5676, SD5677	SD5716, SD5717	SD5756, SD5757	SD5796, SD5797	SD5836, SD5837	SD5876, SD5877	SD5916, SD5917	SD5956, SD5957	Maximum speed	○	R/W	Page 377
SD5678, SD5679	SD5718, SD5719	SD5758, SD5759	SD5798, SD5799	SD5838, SD5839	SD5878, SD5879	SD5918, SD5919	SD5958, SD5959	Bias speed	○	R/W	Page 377
SD5680	SD5720	SD5760	SD5800	SD5840	SD5880	SD5920	SD5960	Acceleration time	○	R/W	Page 378
SD5681	SD5721	SD5761	SD5801	SD5841	SD5881	SD5921	SD5961	Deceleration time	○	R/W	Page 378

R: Read only, R/W: Read/write, ○: Supported, ×: Not supported

\*1 Writing can be performed only by the HCMOV/DHCMOV instruction.

## Outline of operation

For each speed, refer to  Page 375 Items related to speed.

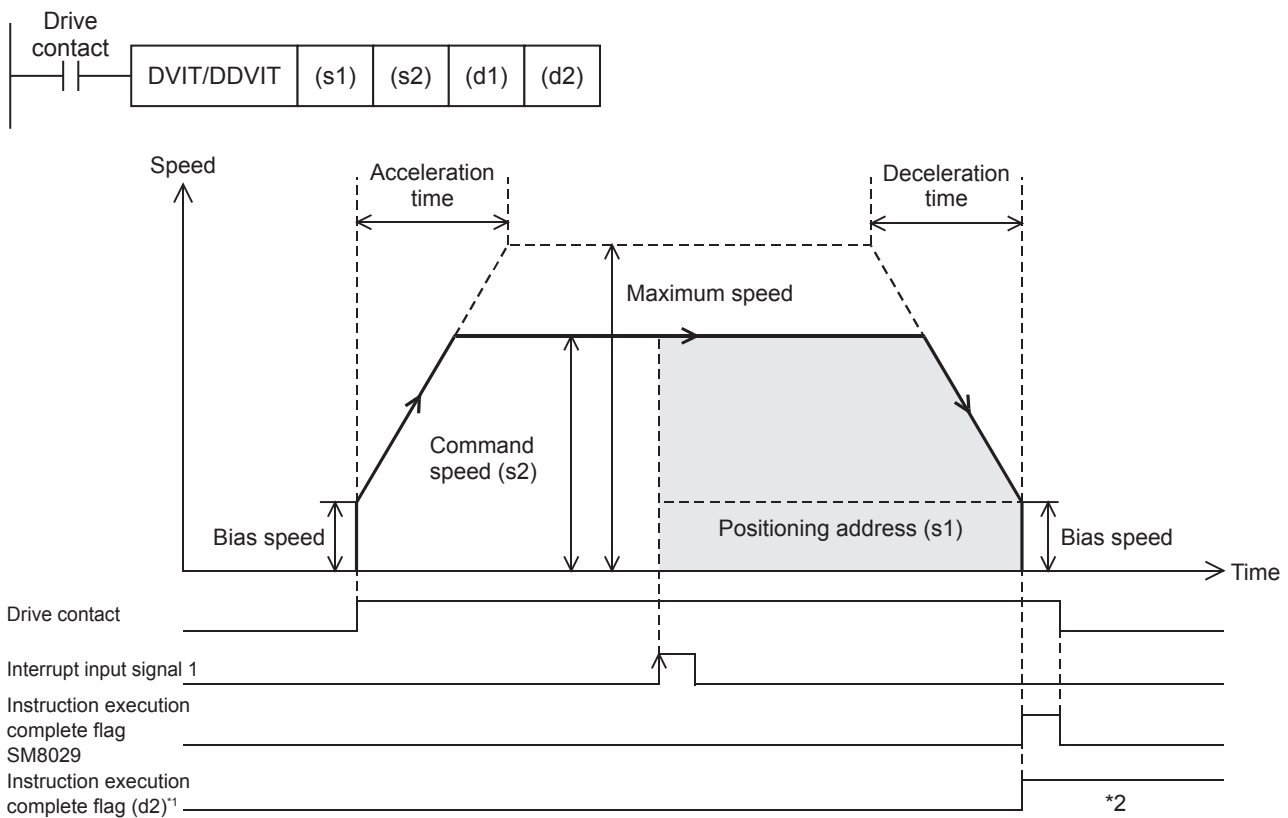

\*1 When FX5 operand is specified

\*2 Remains on until it is turned off using program or engineering tool or the positioning instruction is next driven again.

## Basic operation

The following describes the basic operation.

1. After the drive contact is turned on, pulse output is started and the speed is increased from the bias speed.
2. After the speed has reached the specified speed, the operation will be performed in the specified speed.
3. From the point at which the interrupt input signal 1 is detected, operation for the specified positioning address is performed. (☞ Page 381 Interrupt Input Signal 1)
4. Deceleration starts from near the target position.
5. At the specified positioning address, pulse output is stopped.

## Operand specification

### ■When FX5 operand is specified

1. For (s1), specify the positioning address after the interrupt input signal 1 is detected. (☞ Page 378 Positioning address)  
Set to a value -2147483648 to +2147483647 in pulse.

- DVIT: -32768 to +32767 (User system unit)
- DDVIT: -2147483648 to +2147483647 (User system unit)

2. For (s2), specify the command speed. Set to a value 1 pps to 200 kpps in pulse. For the FX5S CPU module, set to a value 1 to 100 kpps.

- DVIT: 1 to 65535 (User system unit)
- DDVIT: 1 to 2147483647 (User system unit)

3. For (d1), specify an axis number for which pulses are output.

Specify an axis number whose positioning parameters are set in the high speed I/O parameters. Operation cannot be performed if any other axis number is specified.

[FX5S CPU module]

- K1 to K4: Axis 1 to Axis 4

[FX5UJ CPU module]

- K1 to K3: Axis 1 to Axis 3 (CPU module)
- K5, K6: Axis 5, Axis 6 (High-speed pulse input/output module first module)
- K7, K8: Axis 7, Axis 8 (High-speed pulse input/output module second module)
- K9, K10: Axis 9, Axis 10 (High-speed pulse input/output module third module)
- K11, K12: Axis 11, Axis 12 (High-speed pulse input/output module fourth module)

[FX5U/FX5UC CPU module]

- K1 to K4: Axis 1 to Axis 4 (CPU module)
- K5, K6: Axis 5, Axis 6 (High-speed pulse input/output module first module)
- K7, K8: Axis 7, Axis 8 (High-speed pulse input/output module second module)
- K9, K10: Axis 9, Axis 10 (High-speed pulse input/output module third module)
- K11, K12: Axis 11, Axis 12 (High-speed pulse input/output module fourth module)

4. For (d2), specify the bit devices of the instruction execution complete flag and abnormal end flag. (☞ Page 400 Complete flag)

- (d2): Instruction execution complete flag
- (d2)+1: Instruction execution abnormal end flag

## ■When the FX3 compatible operand is specified (Supported only for CPU module)

**1.** For (s1), specify the positioning address after the interrupt input signal 1 is detected.

Set to a value -2147483648 to +2147483647 in pulse.

- DVIT: -32768 to +32767 (User system unit)
- DDVIT: -2147483648 to +2147483647 (User system unit)

**2.** For (s2), specify the command speed. Set to a value 1 pps to 200 kpps in pulse. For the FX5S CPU module, set to a value 1 to 100 kpps.

- DVIT: 1 to 65535 (User system unit)
- DDVIT: 1 to 2147483647 (User system unit)

**3.** For (d1), specify the pulse output number.

Specify an output device (Y) number set in the high speed I/O parameters. (☞ Page 370 Pulse Output Mode) Operation cannot be performed if any other axis number is specified.

- FX5S/FX5U/FX5UC CPU module: Y0 to Y3 (equivalent to axes 1 to 4)
- FX5UJ CPU module: Y0 to Y2 (equivalent to axes 1 to 3)

**4.** For (d2), specify the rotation direction signal output device number. (☞ Page 372 Rotation Direction Setting)

When an output device (Y) is used, only the device that is specified with the positioning parameter or a general-purpose output can be specified. However, if an output device (Y) to which PWM, PULSE/SIGN axis of another axis, or CW/CCW axis is assigned is specified, an error occurs without any operation.

For the PWM function, refer to the following.

☞ Page 319 PWM Function

## Interrupt input signal 1

After the interrupt input signal 1 is detected, pulses equivalent to the specified positioning address specified in (s1) are output starting from the detection point. Deceleration stop starts from point that deceleration must be performed.

### Precautions

- When the interrupt input signal 1 is disabled, the DVIT/DDVIT signal cannot be used.
- If the interrupt input signal 1 is not detected, pulse output at the command speed of (s2) continues until the signal is detected.
- If the total of the pulses that have already been output and pulses to be output after an interrupt exceeds 2147483648 when the interrupt input signal 1 is detected, an error occurs. From the point at which the interrupt input signal 1 is detected, deceleration stop is performed.
- When the interrupt input signal 1 is ON before the start of instruction, the interrupt input signal 1 is not detected even if the DVIT/DDVIT instruction is executed. However, in the case where the interruption input signal 1 is ON and the external start signal is turned ON when the external start signal is used, the interrupt input signal 1 is detected simultaneously when the DVIT/DDVIT instruction is driven.



## Operation of the complete flags

The following describes the operation timings of the complete flags.

The user-specified complete flags are valid only when specified using FX5 operand.

Item	FX3 compatible		User specification	
	Instruction execution complete flag (SM8029)	Instruction execution abnormal end flag (SM8329)	Instruction execution complete flag (d2)	Instruction execution abnormal end flag (d2)+1
ON condition	From when pulse output of the specified positioning address is completed to when the drive contact is turned off	From when the following operation or function is completed to when the drive contact is turned off <ul style="list-style-type: none"> <li>• The axis is already used.*1</li> <li>• Pulse output stop command</li> <li>• Pulse decelerate and stop command</li> <li>• Limit of the moving direction</li> <li>• All module reset when a stop error occurs*2</li> <li>• All outputs disabled (SM8034)</li> <li>• Positioning address error</li> <li>• Deceleration stop after the command speed is changed to 0</li> </ul>	From when pulse output of the specified positioning address is completed to when the ON → OFF condition is met	From when the following operation or function is completed to when the ON → OFF condition is met <ul style="list-style-type: none"> <li>• The axis is already used.</li> <li>• The drive contact is turned off during positioning operation.</li> <li>• Pulse output stop command</li> <li>• Pulse decelerate and stop command</li> <li>• Limit of the moving direction</li> <li>• All module reset when a stop error occurs*2</li> <li>• All outputs disabled (SM8034)</li> <li>• Online change</li> <li>• Positioning address error</li> <li>• Deceleration stop after the command speed is changed to 0</li> </ul>
ON → OFF condition	When the drive contact is turned off		The flag remains on until either of the following is performed. <ul style="list-style-type: none"> <li>• Turning off the flag by the user</li> <li>• Restarting the positioning instruction</li> </ul>	

\*1 The flag turns on only for one scan when the drive contact of the instruction turns from OFF to ON.

\*2 Only high-speed pulse input/output module is supported.

## Program example

The following is a program example of interrupt 1-speed positioning (axis 1).

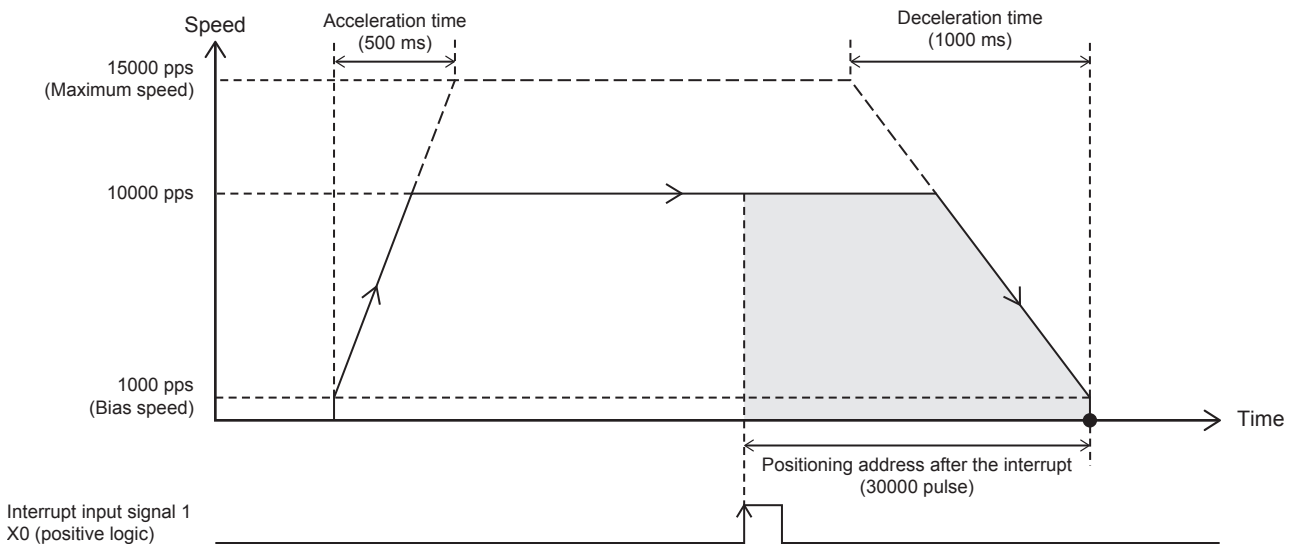

## Setting data

### Positioning parameter (high speed I/O parameter)

Item	Axis 1	Item	Axis 1
■Basic Parameter 1		■Basic Parameter 2	
Pulse Output Mode	1: PULSE/SIGN	Interpolation Speed Specified Method	0: Composite Speed
Output Device (PULSE/CW)	Y0	Max. Speed	15000 pps
Output Device (SIGN/CCW)	Y4	Bias Speed	1000 pps
Rotation Direction Setting	0: Current Address Increment with Forward Run Pulse Output	Acceleration Time	500 ms
Unit Setting	0: Motor System (pulse, pps)	Deceleration Time	1000 ms
No. of Pulse per Rotation	2000 pulse	■Detailed Setting Parameter	
Movement Amount per Rotation	1000 pulse	External Start Signal Enabled/Disabled	0: Disabled
Positioning Data Magnification	1: × Single	Interrupt Input Signal 1 Enabled/Disabled	1: Enabled
—		Interrupt Input Signal 1 Mode	1: Standard Mode
		Interrupt Input Signal 1 Device No.	X0
		Interrupt Input Signal 1 Logic	0: Positive Logic
		Interrupt Input Signal 2 Logic	0: Positive Logic
		■OPR Parameter	
		OPR Enabled/Disabled	0: Disabled

## Program example

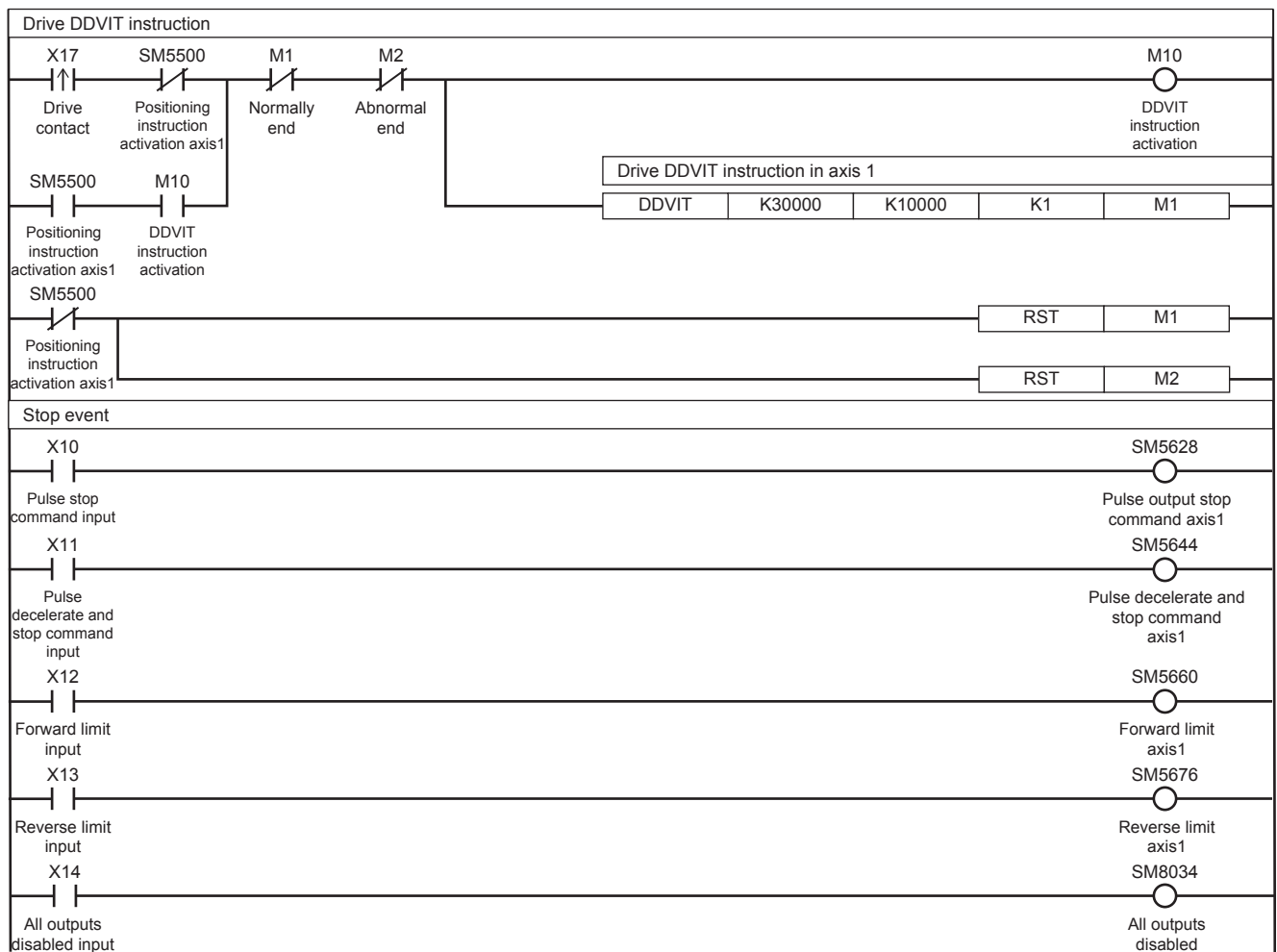

## Caution

- When 0 is set for the positioning address (s1) at start of the instruction, the operation ends with an error.
- If the positioning address (s1) is changed to 0 before the interrupt input signal 1 is detected, the operation decelerates and stops after the input interrupt occurs. After deceleration stop, the output direction is reversed to the address where the positioning address was changed and the operation ends normally.
- When transfer time to the positioning address is shorter than the time required for deceleration stop (the value set in (s1) is small), the operation immediately stops at the positioning address. Note that the immediate stop may damage the machine because the motor stops immediately.

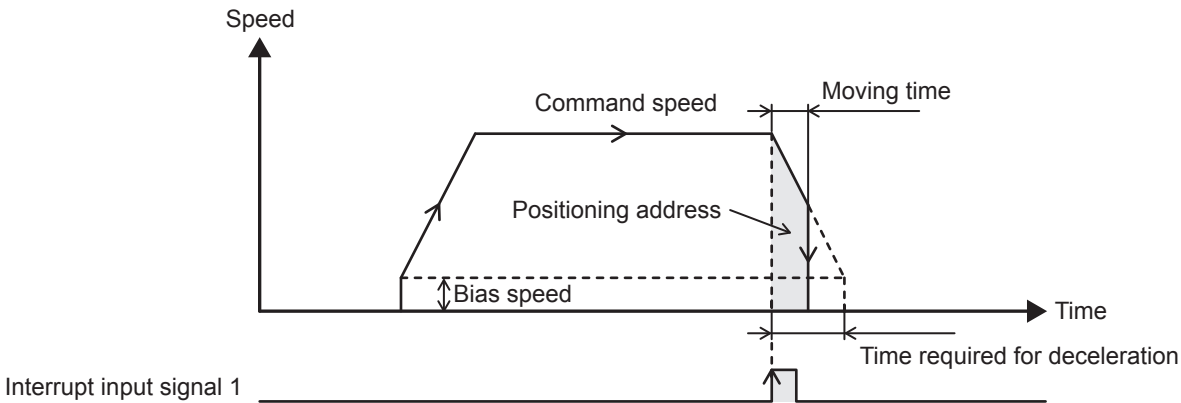

- When the interrupt input signal 1 is detected during acceleration, the operation differs depending on the positioning address value (s1) as shown below.

- 1.** When the positioning address < the number of pulses required for deceleration from the current speed  
After the interrupt input signal 1 is turned on, deceleration immediately starts, and then the operation immediately stops when the positioning address is reached. Note that the immediate stop may damage the machine because the motor stops immediately.
- 2.** When the number of pulses required for deceleration from the current speed  $\leq$  positioning address < the number of pulses required for acceleration/deceleration from the current speed  
The speed is increased until the position at which the remaining number of pulses becomes the same as that required for deceleration. Then, deceleration stop is performed.
- 3.** When the number of pulses required for acceleration/deceleration from the current speed  $\leq$  positioning address  
The speed is increased to the command speed (s2). Then, deceleration stop is performed.

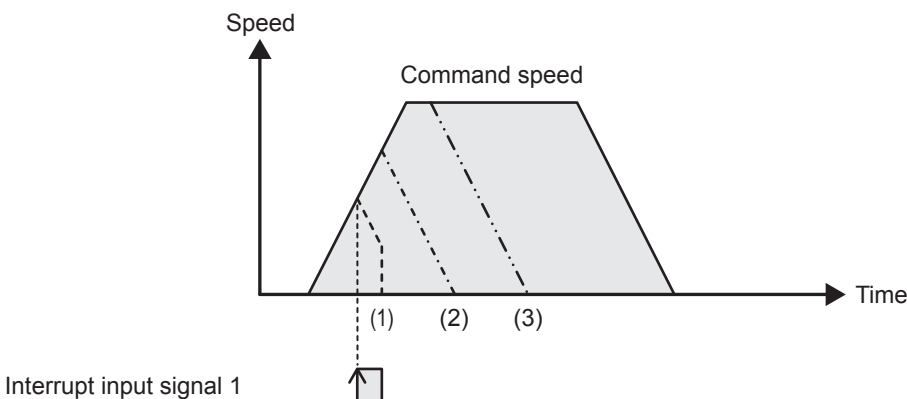

## 32.7 Variable Speed Operation

The positioning function uses the variable speed pulse output instruction equipped with the rotation direction designation function to perform variable speed operation.

This instruction can change the speed using the acceleration/deceleration speed.

### PLSV/DPLSV

This instruction outputs variable speed pulses with an assigned rotation direction output.

Ladder	ST	FBD/LD
	ENO:=PLSV(EN,s,d1,d2); ENO:=DPLSV(EN,s,d1,d2);	

### Setting data

#### ■Description, range, data type (PLSV)

- FX5 operand

Operand	Description	Range	Data type	Data type (label)
(s)	Word device number storing command speed or data*1	-32768 to +32767 (User system unit)	16-bit signed binary	ANY16
(d1)	Axis number from which pulses are output	■FX5S CPU module K1 to K4 ■FX5UJ CPU module K1 to K3, K5 to K12 ■FX5U/FX5UC CPU module K1 to K12	16-bit unsigned binary	ANY_ELEMENTARY (WORD)
(d2)	Bit device number of the instruction execution complete flag and abnormal end flag	—	Bit	ANY_BOOL
EN	Execution condition	—	Bit	BOOL
ENO	Execution result	—	Bit	BOOL

- FX3 compatible operand (Supported only for CPU module)

Operand	Description	Range	Data type	Data type (label)
(s)	Word device number storing command speed or data	-32768 to +32767 (User system unit)	16-bit signed binary	ANY16
(d1)	Bit device number (Y) from which pulses are output	■FX5S/FX5U/FX5UC CPU module Y0 to Y3 ■FX5UJ CPU module Y0 to Y2	Bit	ANY_ELEMENTARY (BOOL)
(d2)	Bit device number from which rotation direction is output	—	Bit	ANY_BOOL
EN	Execution condition	—	Bit	BOOL
ENO	Execution result	—	Bit	BOOL

\*1 OPR speed and creep speed can be changed during positioning operation. (Page 360 Command speed change during positioning operation)

## ■Description, range, data type (DPLSV)

### • FX5 operand

Operand	Description	Range	Data type	Data type (label)
(s)	Word device number storing command speed or data*1	-2147483648 to +2147483647 (User system unit)	32-bit signed binary	ANY32
(d1)	Axis number from which pulses are output	<ul style="list-style-type: none"> <li>■FX5S CPU module K1 to K4</li> <li>■FX5UJ CPU module K1 to K3, K5 to K12</li> <li>■FX5U/FX5UC CPU module K1 to K12</li> </ul>	16-bit unsigned binary	ANY_ELEMENTARY (WORD)
(d2)	Bit device number of the instruction execution complete flag and abnormal end flag	—	Bit	ANY_BOOL
EN	Execution condition	—	Bit	BOOL
ENO	Execution result	—	Bit	BOOL

### • FX3 compatible operand (Supported only for CPU module)

Operand	Description	Range	Data type	Data type (label)
(s)	Word device number storing command speed or data*1	-2147483648 to +2147483647 (User system unit)	32-bit signed binary	ANY32
(d1)	Bit device number (Y) from which pulses are output	<ul style="list-style-type: none"> <li>■FX5S/FX5U/FX5UC CPU module Y0 to Y3</li> <li>■FX5UJ CPU module Y0 to Y2</li> </ul>	Bit	ANY_ELEMENTARY (BOOL)
(d2)	Bit device number from which rotation direction is output	—	Bit	ANY_BOOL
EN	Execution condition	—	Bit	BOOL
ENO	Execution result	—	Bit	BOOL

\*1 OPR speed and creep speed can be changed during positioning operation. (Page 360 Command speed change during positioning operation)

## ■Available device (PLSV/DPLSV)

### • FX5 operand

Operand	Bit	Word			Double word		Indirect specification	Constant			Others
	X, Y, M, L, SM, F, B, SB, S	T, ST, C, D, W, SD, SW, R	U□\G□	Z	LC	LZ		K, H	E	\$	
(s)	○	○	○	○	○*1	○*1	○	○	—	—	—
(d1)	—	○	○	○	—	—	○	○	—	—	—
(d2)*2	○	○*3	—	—	—	—	—	—	—	—	—

### • FX3 compatible operand (Supported only for CPU module)

Operand	Bit	Word			Double word		Indirect specification	Constant			Others
	X, Y, M, L, SM, F, B, SB, S	T, ST, C, D, W, SD, SW, R	U□\G□	Z	LC	LZ		K, H	E	\$	
(s)	○	○	○	○	○*1	○*1	○	○	—	—	—
(d1)	○*4	—	—	—	—	—	—	—	—	—	—
(d2)	○*5	○*3	—	—	—	—	—	—	—	—	—

\*1 Only available for DPLSV instruction.

\*2 Two devices are occupied from the specified device.

\*3 T, ST, C cannot be used.

\*4 FX5S/FX5U/FX5UC CPU module: Only Y0 to Y3 devices can be used.  
FX5UJ CPU module: Only Y0 to Y2 devices can be used.

\*5 When the output mode is CW/CCW, specify the CCW axis. When the output mode is PULSE/SIGN, only the SIGN output of the axis or general-purpose output can be specified.

## Processing details

This instruction outputs variable speed pulses with an assigned rotation direction output.

## Related devices

The following lists the related special devices.

Related devices of axis 4 are available only for the FX5S/FX5U/FX5UC CPU module.

### Special relays

#### ■CPU module

FX5 dedicated				FX3 compatible				Name	High Speed I/O Parameter	R/W	Reference
Axis 1	Axis 2	Axis 3	Axis 4	Axis 1	Axis 2	Axis 3	Axis 4				
—	—	—	—	SM8029				Instruction execution complete flag	×	R	Page 400
—	—	—	—	SM8329				Instruction execution abnormal end flag	×	R	
SM5500	SM5501	SM5502	SM5503	SM8348	SM8358	SM8368	SM8378	Positioning instruction activation	×	R	Page 398
SM5516	SM5517	SM5518	SM5519	SM8340	SM8350	SM8360	SM8370	Pulse output monitor	×	R	Page 398
SM5532	SM5533	SM5534	SM5535	—	—	—	—	Positioning error occurrence	×	R/W	Page 398
SM5628	SM5629	SM5630	SM5631	—	—	—	—	Pulse output stop command	×	R/W	Page 382
SM5644	SM5645	SM5646	SM5647	—	—	—	—	Pulse decelerate and stop command	×	R/W	Page 383
SM5660	SM5661	SM5662	SM5663	—	—	—	—	Forward limit	×	R/W	Page 384
SM5676	SM5677	SM5678	SM5679	—	—	—	—	Reverse limit	×	R/W	Page 384
SM5772	SM5773	SM5774	SM5775	—	—	—	—	Rotation direction setting	○	R/W	Page 372

R: Read only, R/W: Read/write, ○: Supported, ×: Not supported

#### ■High-speed pulse input/output module

First module		Second module		Third module		Fourth module		Name	High Speed I/O Parameter	R/W	Reference
Axis 5	Axis 6	Axis 7	Axis 8	Axis 9	Axis 10	Axis 11	Axis 12				
SM8029 (FX3 compatible device)								Instruction execution complete flag	×	R	Page 400
SM8329 (FX3 compatible device)								Instruction execution abnormal end flag	×	R	
SM5504	SM5505	SM5506	SM5507	SM5508	SM5509	SM5510	SM5511	Positioning instruction activation	×	R	Page 398
SM5520	SM5521	SM5522	SM5523	SM5524	SM5525	SM5526	SM5527	Pulse output monitor	×	R	Page 398
SM5536	SM5537	SM5538	SM5539	SM5540	SM5541	SM5542	SM5543	Positioning error occurrence	×	R/W	Page 398
SM5632	SM5633	SM5634	SM5635	SM5636	SM5637	SM5638	SM5639	Pulse output stop command	×	R/W	Page 382
SM5648	SM5649	SM5650	SM5651	SM5652	SM5653	SM5654	SM5655	Pulse decelerate and stop command	×	R/W	Page 383
SM5664	SM5665	SM5666	SM5667	SM5668	SM5669	SM5670	SM5671	Forward limit	×	R/W	Page 384
SM5680	SM5681	SM5682	SM5683	SM5684	SM5685	SM5686	SM5687	Reverse limit	×	R/W	Page 384
SM5776	SM5777	SM5778	SM5779	SM5780	SM5781	SM5782	SM5783	Rotation direction setting	○	R/W	Page 372

R: Read only, R/W: Read/write, ○: Supported, ×: Not supported

## Special registers

### ■CPU module

FX5 dedicated				FX3 compatible				Name	High Speed I/O Parameter	R/W	Reference
Axis 1	Axis 2	Axis 3	Axis 4	Axis 1	Axis 2	Axis 3	Axis 4				
SD5500, SD5501	SD5540, SD5541	SD5580, SD5581	SD5620, SD5621	—	—	—	—	Current address (user unit)	×	R/W <sup>*1</sup>	Page 380
SD5502, SD5503	SD5542, SD5543	SD5582, SD5583	SD5622, SD5623	SD8340, SD8341	SD8350, SD8351	SD8360, SD8361	SD8370, SD8371	Current address (pulse unit)	×	R/W <sup>*1</sup>	Page 380
SD5504, SD5505	SD5544, SD5545	SD5584, SD5585	SD5624, SD5625	—	—	—	—	Current speed (user unit)	×	R	Page 376
SD5510	SD5550	SD5590	SD5630	—	—	—	—	Positioning error (error code)	×	R/W	Page 399
SD5516, SD5517	SD5556, SD5557	SD5596, SD5597	SD5636, SD5637	—	—	—	—	Maximum speed	○	R/W	Page 377
SD5518, SD5519	SD5558, SD5559	SD5598, SD5599	SD5638, SD5639	—	—	—	—	Bias speed	○	R/W	Page 377
SD5520	SD5560	SD5600	SD5640	—	—	—	—	Acceleration time	○	R/W	Page 378
SD5521	SD5561	SD5601	SD5641	—	—	—	—	Deceleration time	○	R/W	Page 378

R: Read only, R/W: Read/write, ○: Supported, ×: Not supported

\*1 Only FX5 dedicated devices can be written by the HCMOV/DHCMOV instruction.

### ■High-speed pulse input/output module

First module		Second module		Third module		Fourth module		Name	High Speed I/O Parameter	R/W	Reference
Axis 5	Axis 6	Axis 7	Axis 8	Axis 9	Axis 10	Axis 11	Axis 12				
SD5660, SD5661	SD5700, SD5701	SD5740, SD5741	SD5780, SD5781	SD5820, SD5821	SD5860, SD5861	SD5900, SD5901	SD5940, SD5941	Current address (user unit)	×	R/W <sup>*1</sup>	Page 380
SD5662, SD5663	SD5702, SD5703	SD5742, SD5743	SD5782, SD5783	SD5822, SD5823	SD5862, SD5863	SD5902, SD5903	SD5942, SD5943	Current address (pulse unit)	×	R/W <sup>*1</sup>	Page 380
SD5664, SD5665	SD5704, SD5705	SD5744, SD5745	SD5784, SD5785	SD5824, SD5825	SD5864, SD5865	SD5904, SD5905	SD5944, SD5945	Current speed (user unit)	×	R	Page 376
SD5670	SD5710	SD5750	SD5790	SD5830	SD5870	SD5910	SD5950	Positioning error (error code)	×	R/W	Page 399
SD5676, SD5677	SD5716, SD5717	SD5756, SD5757	SD5796, SD5797	SD5836, SD5837	SD5876, SD5877	SD5916, SD5917	SD5956, SD5957	Maximum speed	○	R/W	Page 377
SD5678, SD5679	SD5718, SD5719	SD5758, SD5759	SD5798, SD5799	SD5838, SD5839	SD5878, SD5879	SD5918, SD5919	SD5958, SD5959	Bias speed	○	R/W	Page 377
SD5680	SD5720	SD5760	SD5800	SD5840	SD5880	SD5920	SD5960	Acceleration time	○	R/W	Page 378
SD5681	SD5721	SD5761	SD5801	SD5841	SD5881	SD5921	SD5961	Deceleration time	○	R/W	Page 378

R: Read only, R/W: Read/write, ○: Supported, ×: Not supported

\*1 Writing can be performed only by the HCMOV/DHCMOV instruction.

# Outline of operation

For each speed, refer to  Page 375 Items related to speed.

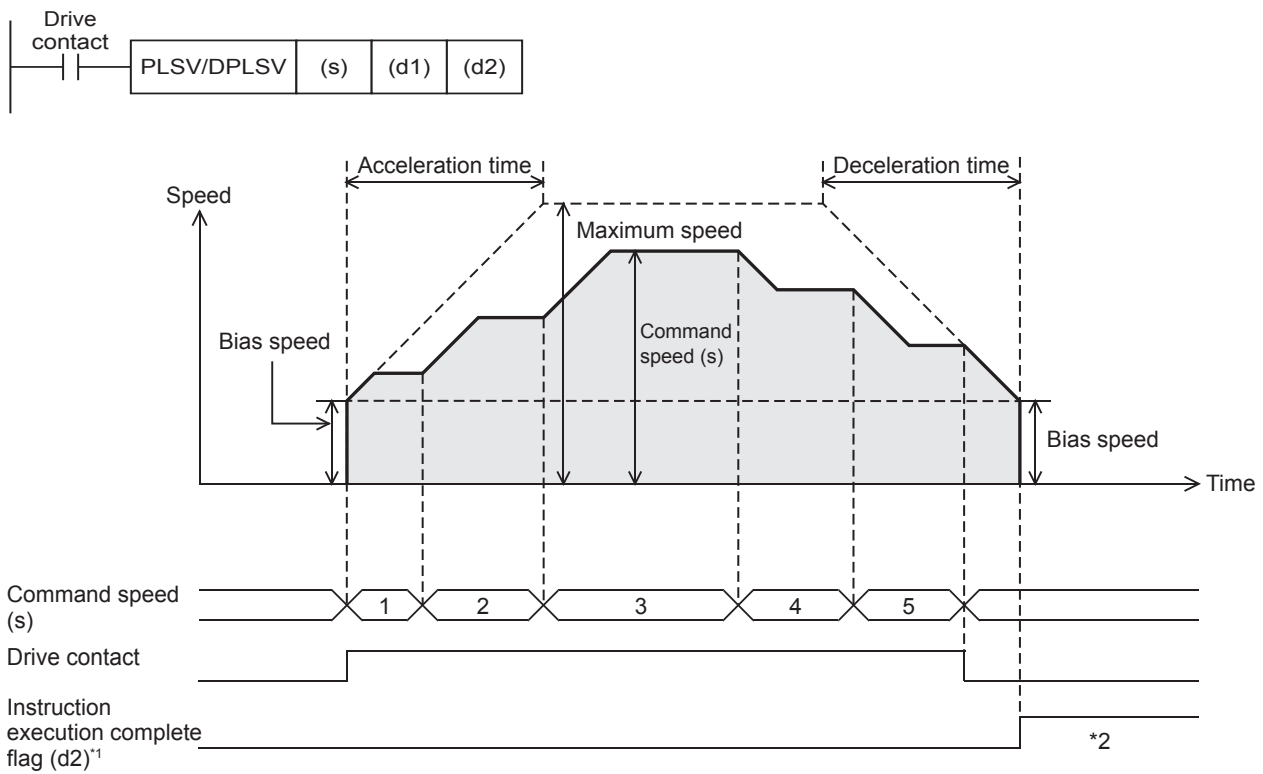

\*1 When FX5 operand is specified

\*2 Remains on until it is turned off using program or engineering tool or the positioning instruction is next driven again.

## Basic operation

The following describes the basic operation.

- 1.** After the drive contact is turned on, pulse output is started and the speed is increased from the bias speed.
- 2.** After the speed has reached the specified speed, the operation will be performed in the specified speed.
- 3.** If the command speed is changed during operation, the speed is increased/decreased to the specified speed and operation continues.
- 4.** If the drive contact is turned off, the speed is decreased and pulse output is stopped.



## Operand specification

### ■When FX5 operand is specified

**1.** For (s), specify the command speed. Set to a value -200 kpps to +200 kpps in pulse. For the FX5S CPU module, set to a value -100 kpps to +100 kpps.

- PLSV: -32768 to +32767 (User system unit)
- DPLSV: -2147483648 to +2147483647 (User system unit)

**2.** For (d1), specify an axis number for which pulses are output.

Specify an axis number whose positioning parameters are set in the high speed I/O parameters. Operation cannot be performed if any other axis number is specified.

[FX5S CPU module]

- K1 to K4: Axis 1 to Axis 4

[FX5UJ CPU module]

- K1 to K3: Axis 1 to Axis 3 (CPU module)
- K5, K6: Axis 5, Axis 6 (High-speed pulse input/output module first module)
- K7, K8: Axis 7, Axis 8 (High-speed pulse input/output module second module)
- K9, K10: Axis 9, Axis 10 (High-speed pulse input/output module third module)
- K11, K12: Axis 11, Axis 12 (High-speed pulse input/output module fourth module)

[FX5U/FX5UC CPU module]

- K1 to K4: Axis 1 to Axis 4 (CPU module)
- K5, K6: Axis 5, Axis 6 (High-speed pulse input/output module first module)
- K7, K8: Axis 7, Axis 8 (High-speed pulse input/output module second module)
- K9, K10: Axis 9, Axis 10 (High-speed pulse input/output module third module)
- K11, K12: Axis 11, Axis 12 (High-speed pulse input/output module fourth module)

**3.** For (d2), specify the bit devices of the instruction execution complete flag and abnormal end flag. (  Page 400 Complete flag)

- (d2): Instruction execution complete flag
- (d2)+1: Instruction execution abnormal end flag

### ■When the FX3 compatible operand is specified (Supported only for CPU module)

**1.** For (s), specify the command speed. Set to a value -200 kpps to +200 kpps in pulse. For the FX5S CPU module, set to a value -100 kpps to +100 kpps.

- PLSV: -32768 to +32767 (User system unit)
- DPLSV: -2147483648 to +2147483647 (User system unit)

**2.** For (d1), specify the pulse output number.

Specify an output device (Y) number set in the high speed I/O parameters. (  Page 370 Pulse Output Mode) Operation cannot be performed if any other axis number is specified.

- FX5S/FX5U/FX5UC CPU module: Y0 to Y3 (equivalent to axes 1 to 4)
- FX5UJ CPU module: Y0 to Y2 (equivalent to axes 1 to 3)

**3.** For (d2), specify the rotation direction signal output device number. (  Page 372 Rotation Direction Setting)

When an output device (Y) is used, only the device that is specified with the positioning parameter or a general-purpose output can be specified. However, if an output device (Y) to which PWM, PULSE/SIGN axis of another axis, or CW/CCW axis is assigned is specified, an error occurs without any operation.

For the PWM function, refer to the following.

 Page 319 PWM Function

## Command speed

- If the command speed is changed to 0 during operation, the operation does not end with errors but is decelerated to a stop. As long as the drive contact is on, changing the command speed restarts pulse output.
- When 0 is set for the command speed at start of the instruction, the operation ends with an error.

## Acceleration/deceleration operation

- When acceleration time is set to 0, the speed is increased to the command speed immediately without acceleration operation.
- When deceleration time is set to 0, no deceleration operation is performed and operation immediately stops when the drive contact is turned off.

## Operation of the complete flags

The following describes the operation timings of the complete flags.

The user-specified complete flags are valid only when specified using FX5 operand.

Item	FX3 compatible		User specification	
	Instruction execution complete flag (SM8029)	Instruction execution abnormal end flag (SM8329)	Instruction execution complete flag (d2)	Instruction execution abnormal end flag (d2)+1
ON condition	From when deceleration stop is performed by the pulse decelerate and stop command to when the ON → OFF condition is met	From when the following operation or function is completed to when the drive contact is turned off <ul style="list-style-type: none"> <li>• The axis is already used.*1</li> <li>• Pulse output stop command</li> <li>• Limit of the moving direction</li> <li>• All module reset when a stop error occurs*2</li> <li>• All outputs disabled (SM8034)</li> <li>• When 0 is set for the command speed at start of the instruction</li> </ul>	From when the drive contact is turned off or when deceleration stop is performed by the pulse decelerate and stop command to when the ON → OFF condition is met	From when the following operation or function is completed to when the ON → OFF condition is met <ul style="list-style-type: none"> <li>• The axis is already used.</li> <li>• Pulse output stop command</li> <li>• Limit of the moving direction</li> <li>• All module reset when a stop error occurs*2</li> <li>• All outputs disabled (SM8034)</li> <li>• Online change</li> <li>• When 0 is set for the command speed at start of the instruction</li> </ul>
ON → OFF condition	When the drive contact is turned off		The flag remains on until either of the following is performed. <ul style="list-style-type: none"> <li>• Turning off the flag by the user</li> <li>• Restarting the positioning instruction</li> </ul>	

\*1 The flag turns on only for one scan when the drive contact of the instruction turns from OFF to ON.

\*2 Only high-speed pulse input/output module is supported.

# Program example

The following is a program example of variable speed operation (axis 1).

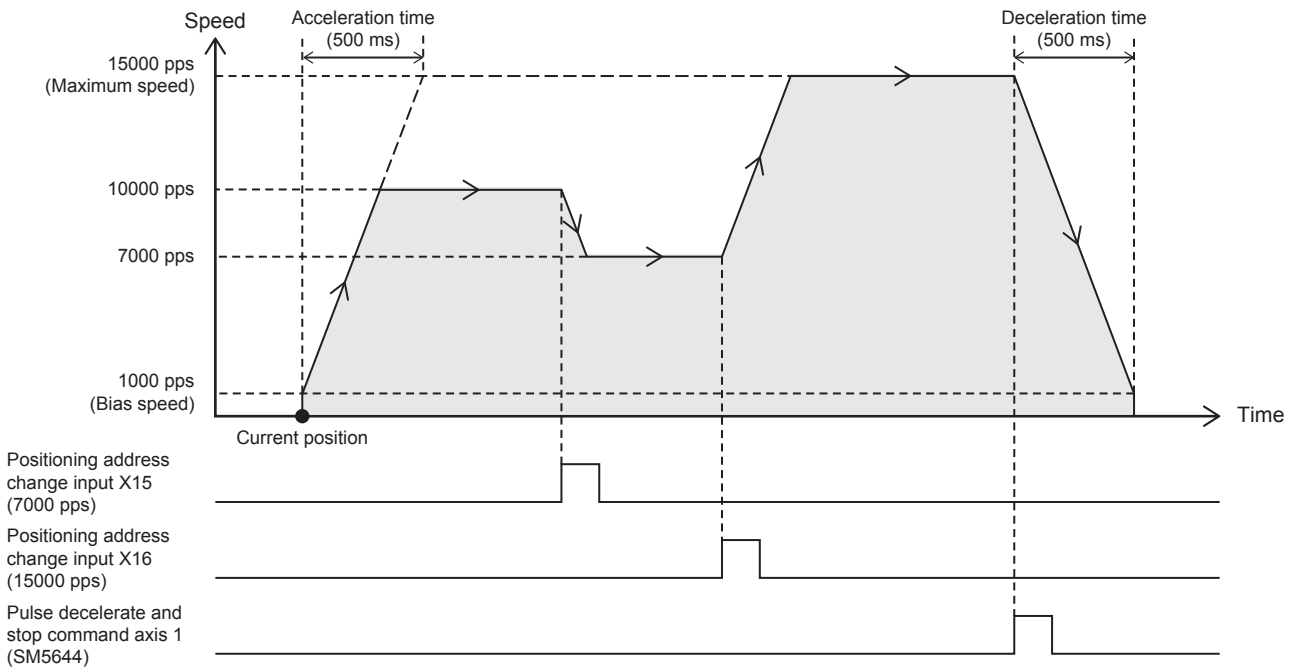

## Setting data

### ■ Positioning parameter (high speed I/O parameter)

Item	Axis 1	Item	Axis 1
■ Basic Parameter 1		■ Basic Parameter 2	
Pulse Output Mode	1: PULSE/SIGN	Interpolation Speed Specified Method	0: Composite Speed
Output Device (PULSE/CW)	Y0	Max. Speed	15000 pps
Output Device (SIGN/CCW)	Y4	Bias Speed	1000 pps
Rotation Direction Setting	0: Current Address Increment with Forward Run Pulse Output	Acceleration Time	500 ms
Unit Setting	0: Motor System (pulse, pps)	Deceleration Time	500 ms
No. of Pulse per Rotation	2000 pulse	■ Detailed Setting Parameter	
Movement Amount per Rotation	1000 pulse	External Start Signal Enabled/Disabled	0: Disabled
Positioning Data Magnification	1: × Single	Interrupt Input Signal 1 Enabled/Disabled	0: Disabled
—		Interrupt Input Signal 2 Logic	0: Positive Logic
		■ OPR Parameter	
		OPR Enabled/Disabled	0: Disabled

## Program example

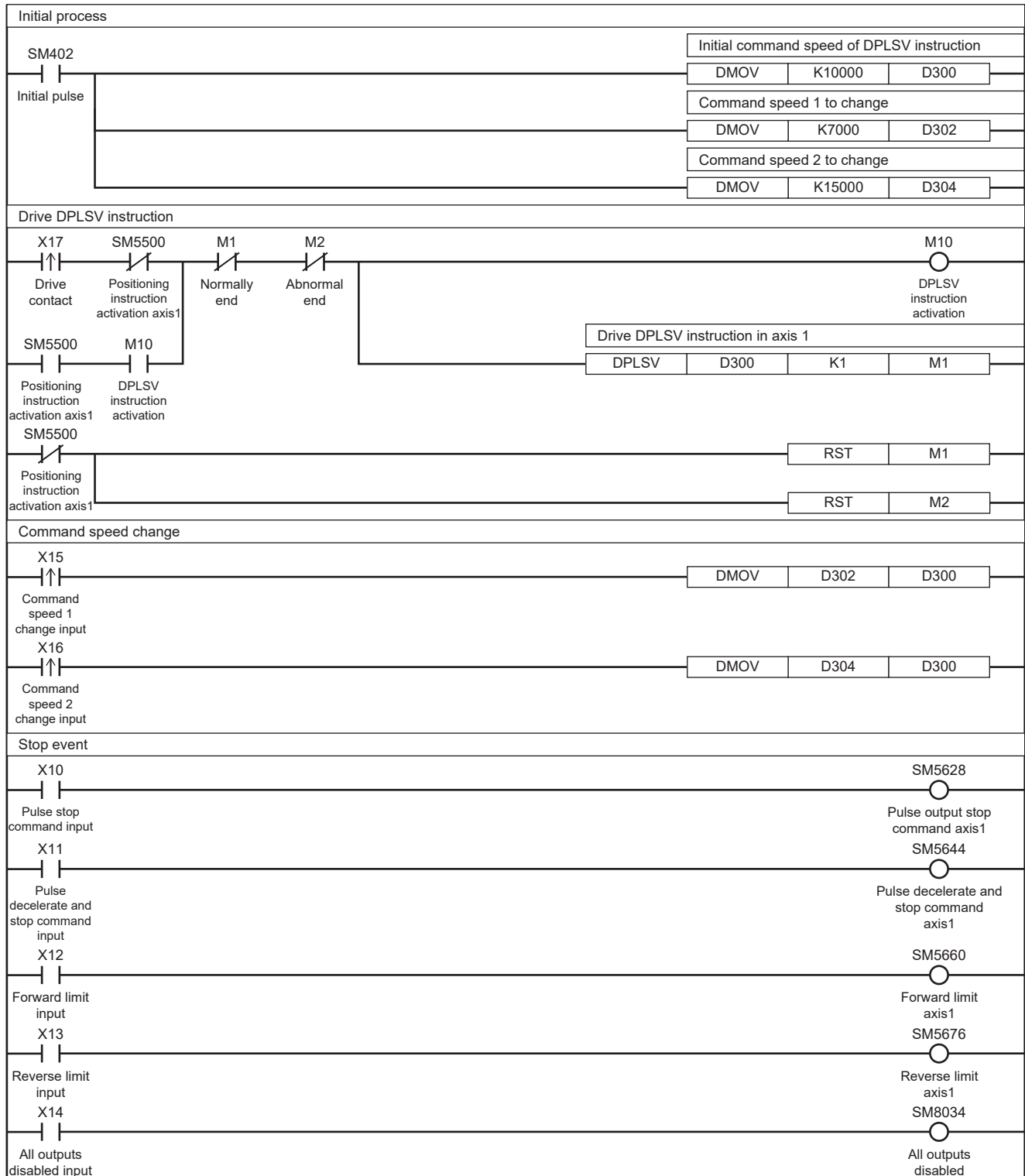

## Caution

- If the speed is changed changing and thus, the sign of the command speed during operation, pulse output is started in the reversed direction after deceleration stop. The waiting time for the pulse output after deceleration stop is "1 ms + scan time". When the motor cannot be stopped during the waiting time, design a program so that sufficient waiting time is secured and then the output is restarted after deceleration stop by setting the command speed to 0 once.
- When 0 is set for the command speed at start of the instruction, the operation ends with an error.

## 32.8 Single-table Operation

This instruction executes the control method of one specified table set in the data table with GX Works3. Only CPU module is supported.

### TBL

This instruction executes one table specified in the table data set in GX Works3.

Ladder	ST	FBD/LD
	ENO:=TBL(EN,n,d);	

### Setting data

#### ■Description, range, data type

- FX5 operand

Operand	Description	Range	Data type	Data type (label)
(d)	Axis number from which pulses are output	■FX5S/FX5U/FX5UC CPU module K1 to K4 ■FX5UJ CPU module K1 to K3	16-bit unsigned binary	ANY_ELEMENTARY (WORD)
(n)	Table number to be executed	1 to 100 <sup>*1</sup>	16-bit unsigned binary	ANY16_U
EN	Execution condition	—	Bit	BOOL
ENO	Execution result	—	Bit	BOOL

- FX3 compatible operand

Operand	Description	Range	Data type	Data type (label)
(d)	Bit device number (Y) from which pulses are output	■FX5S/FX5U/FX5UC CPU module Y0 to Y3 ■FX5UJ CPU module Y0 to Y2	Bit	ANY_ELEMENTARY (BOOL)
(n)	Table number to be executed	1 to 100 <sup>*1</sup>	16-bit unsigned binary	ANY16_U
EN	Execution condition	—	Bit	BOOL
ENO	Execution result	—	Bit	BOOL

\*1 1 to 32 when the positioning table data is not set to use device

## Available device

- FX5 operand

Operand	Bit	Word			Double word		Indirect specification	Constant			Others
	X, Y, M, L, SM, F, B, SB, S	T, ST, C, D, W, SD, SW, R	U□\G□	Z	LC	LZ		K, H	E	\$	
(d)	—	○	○	○	—	—	○	○	—	—	—
(n)	○	○	○	○	—	—	○	○	—	—	—

- FX3 compatible operand

Operand	Bit	Word			Double word		Indirect specification	Constant			Others
	X, Y, M, L, SM, F, B, SB, S	T, ST, C, D, W, SD, SW, R	U□\G□	Z	LC	LZ		K, H	E	\$	
(d)	○ <sup>*1</sup>	—	—	—	—	—	—	—	—	—	—
(n)	○	○	○	○	—	—	○	○	—	—	—

\*1 FX5UJ CPU module: Only Y0 to Y2 devices can be used.

FX5S/FX5U/FX5UC CPU module: Only Y0 to Y3 devices can be used.

## Processing details

This instruction executes one table specified in the table data set in GX Works3.

For details on the table setting method and others, refer to  Page 487 TABLE OPERATION.

## Related devices

The following lists the related special devices. The devices other than the following depend on the table control method.

Related devices of axis 4 are available only for the FX5S/FX5U/FX5UC CPU module.

### Special relays

Axis 1	Axis 2	Axis 3	Axis 4	Name	High Speed I/O Parameter	R/W	Reference
SM5916	SM5917	SM5918	SM5919	Positioning table data initialization disable	×	R/W	Page 397

R: Read only, R/W: Read/write, ×: Not supported

### Special registers

Axis 1	Axis 2	Axis 3	Axis 4	Name	High Speed I/O Parameter	R/W	Reference
SD5506	SD5546	SD5586	SD5626	Positioning execution table number	×	R	Page 396
SD5511	SD5551	SD5591	SD5631	Positioning error (error occurrence table No.)	×	R/W	Page 397

R: Read only, R/W: Read/write, ×: Not supported

# Outline of operation

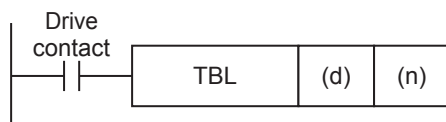

## Operand specification

### ■When FX5 operand is specified

1. For (d), specify an axis number for which pulses are output.

Specify an axis number whose positioning parameters are set in the high speed I/O parameters. Operation cannot be performed if any other axis number is specified.

- FX5S/FX5U/FX5UC CPU module: K1 to K4 (Axis 1 to Axis 4)
- FX5UJ CPU module: K1 to K3 (Axis 1 to Axis 3)

2. For (n), specify the table number (1 to 100<sup>\*1</sup>) that is executed in the axis specified in (d).

\*1 1 to 32 when the positioning table data is not set to use device

### ■When the FX3 compatible operand is specified

1. For (d), specify the pulse output number.



Specify an output device (Y) number set in the high speed I/O parameters. (  Page 370 Pulse Output Mode) Operation cannot be performed if any other axis number is specified.

- FX5S/FX5U/FX5UC CPU module: Y0 to Y3 (equivalent to axes 1 to 4)
- FX5UJ CPU module: Y0 to Y2 (equivalent to axes 1 to 3)

2. For (n), specify the table number (1 to 100<sup>\*1</sup>) that is executed in the axis specified in (d).

\*1 1 to 32 when the positioning table data is not set to use device

## Relation with the DRVTBL and DRVMUL instructions

- With the TBL instruction, only the specified table can be activated. Only the complete flag common with other instructions operates.
- With one DRVTBL instruction, multiple tables can be activated. In addition, the table execution method can be selected from the stepping operation and continuous operation. (  Page 468 Multiple-table Operation)
- With the DRVMUL instruction, tables for up to four axes can be activated at the same time. (  Page 476 Multiple-axis Table Operation) In addition, by indirectly specifying table numbers, continuous operation can be performed.
- For the DRVTBL and DRVMUL instructions, user-specified complete flags can be specified.

## Operation of the complete flags

The operation timing of the complete flags depends on the table control method. (  Page 400 Complete flag)

# Program example

The following are program examples of using each table control method.

## Table transition variable speed operation

The following is a program example of control method [5: Table Transition Variable Speed Operation].

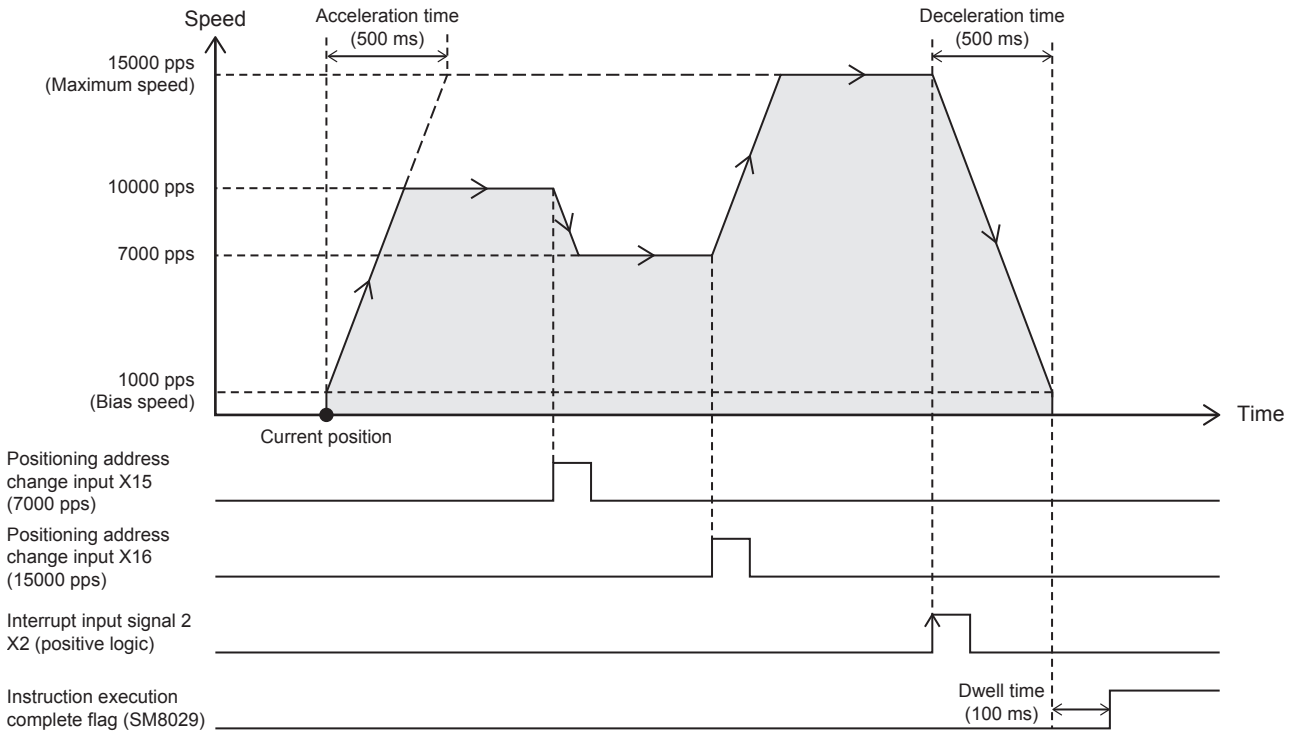

## Setting data

### Positioning parameter (high speed I/O parameter)

Item	Axis 1	Item	Axis 1
■Basic Parameter 1		■Basic Parameter 2	
Pulse Output Mode	1: PULSE/SIGN	Interpolation Speed Specified Method	0: Composite Speed
Output Device (PULSE/CW)	Y0	Max. Speed	15000 pps
Output Device (SIGN/CCW)	Y4	Bias Speed	1000 pps
Rotation Direction Setting	0: Current Address Increment with Forward Run Pulse Output	Acceleration Time	500 ms
Unit Setting	0: Motor System (pulse, pps)	Deceleration Time	500 ms
No. of Pulse per Rotation	2000 pulse	■Detailed Setting Parameter	
Movement Amount per Rotation	1000 pulse	External Start Signal Enabled/Disabled	0: Disabled
Positioning Data Magnification	1: × Single	Interrupt Input Signal 1 Enabled/Disabled	0: Disabled
—		Interrupt Input Signal 2 Logic	0: Positive Logic
		■OPR Parameter	
		OPR Enabled/Disabled	0: Disabled

### Axis #1 Positioning Data (the positioning table data is set to use device)

No.	Device	Control Method	Command Speed	Dwell Time	Interrupt Input Signal 2 Device No.
1	D300	5: Table Transition Variable Speed Operation	10000 pps	100 ms	X2



## Program example

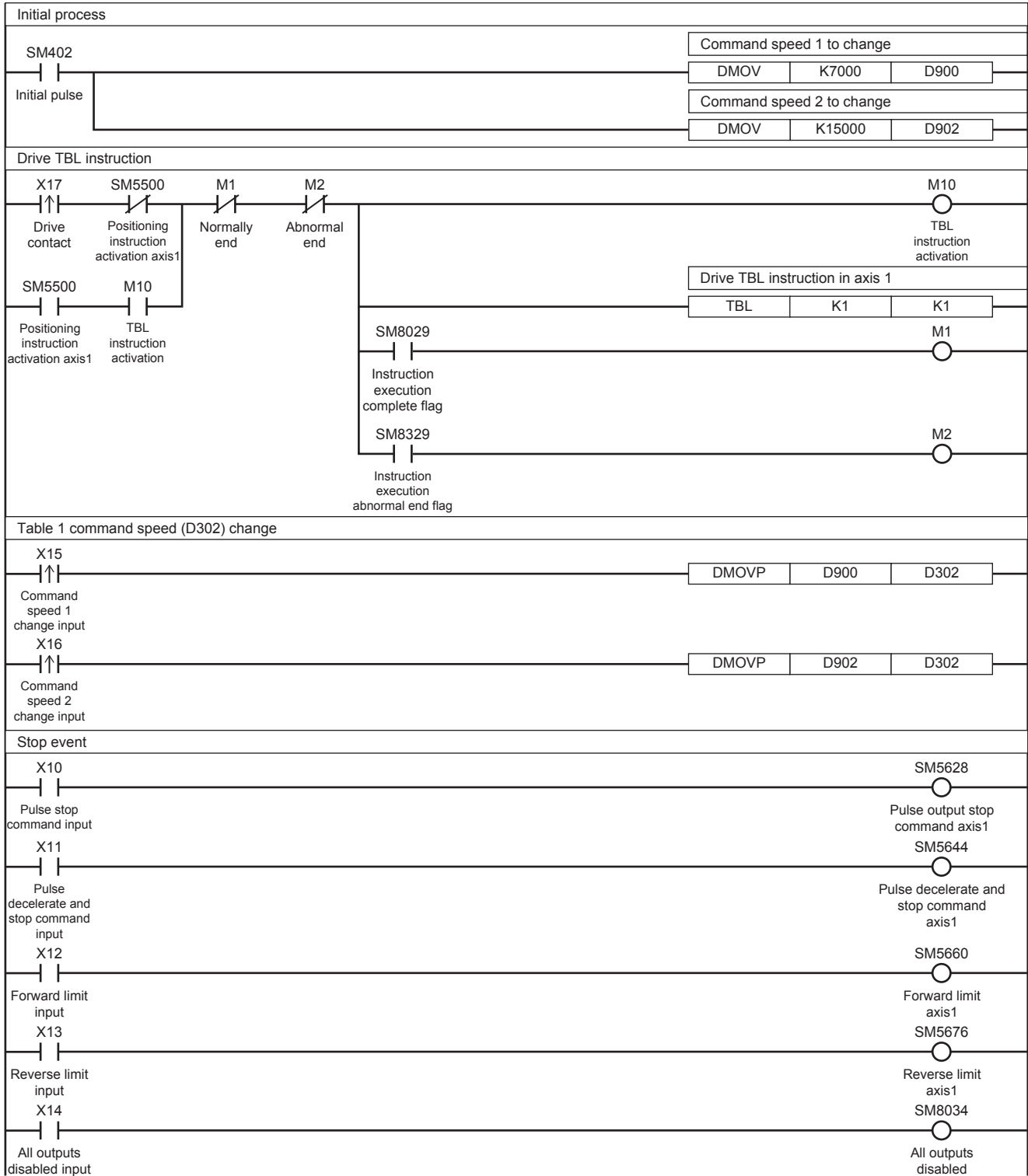

## Interrupt stop (relative address specification)

The following is a program example of control method [6: Interrupt Stop (Relative Address Specification)].

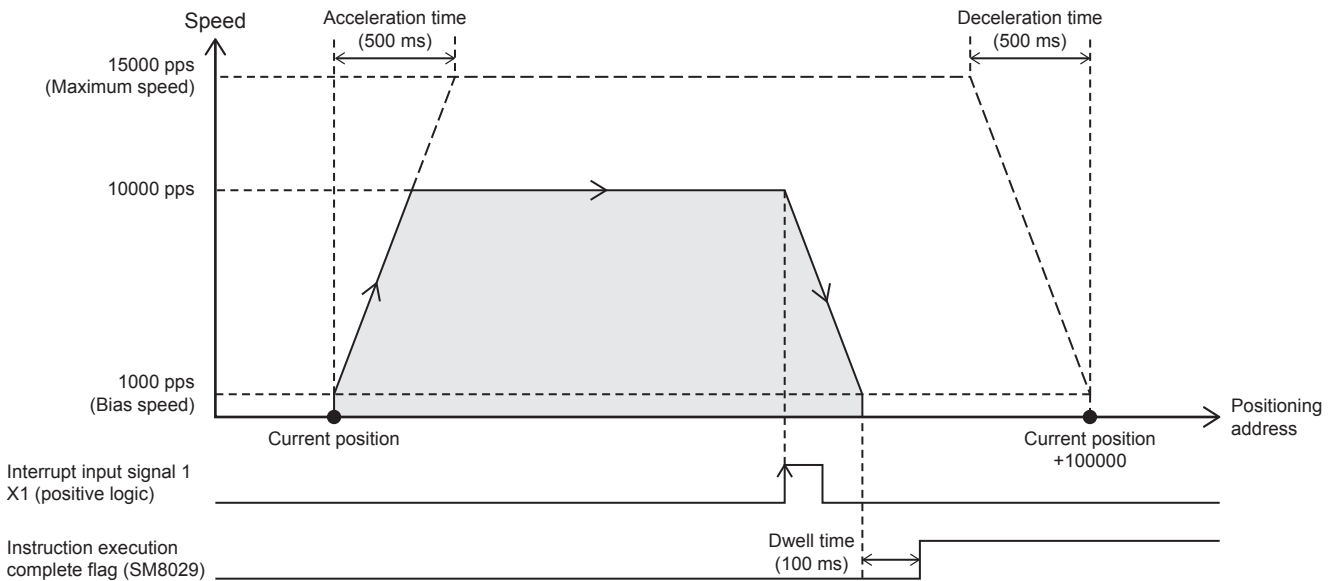

## Setting data

### Positioning parameter (high speed I/O parameter)

Item	Axis 1	Item	Axis 1
■Basic Parameter 1		■Basic Parameter 2	
Pulse Output Mode	1: PULSE/SIGN	Interpolation Speed Specified Method	0: Composite Speed
Output Device (PULSE/CW)	Y0	Max. Speed	15000 pps
Output Device (SIGN/CCW)	Y4	Bias Speed	1000 pps
Rotation Direction Setting	0: Current Address Increment with Forward Run Pulse Output	Acceleration Time	500 ms
Unit Setting	0: Motor System (pulse, pps)	Deceleration Time	500 ms
No. of Pulse per Rotation	2000 pulse	■Detailed Setting Parameter	
Movement Amount per Rotation	1000 pulse	External Start Signal Enabled/Disabled	0: Disabled
Positioning Data Magnification	1: × Single	Interrupt Input Signal 1 Enabled/Disabled	1: Enabled
		Interrupt Input Signal 1 Mode	1: Standard Mode
		Interrupt Input Signal 1 Device No.	X1
		Interrupt Input Signal 1 Logic	0: Positive Logic
		Interrupt Input Signal 2 Logic	0: Positive Logic
		■OPR Parameter	
		OPR Enabled/Disabled	0: Disabled

### Axis #1 Positioning Data (the positioning table data is set to use device)

No.	Device	Control Method	Positioning Address	Command Speed	Dwell Time
1	D300	6: Interrupt Stop (Relative Address Specification)	100000 pulse	10000 pps	100 ms

## Program example

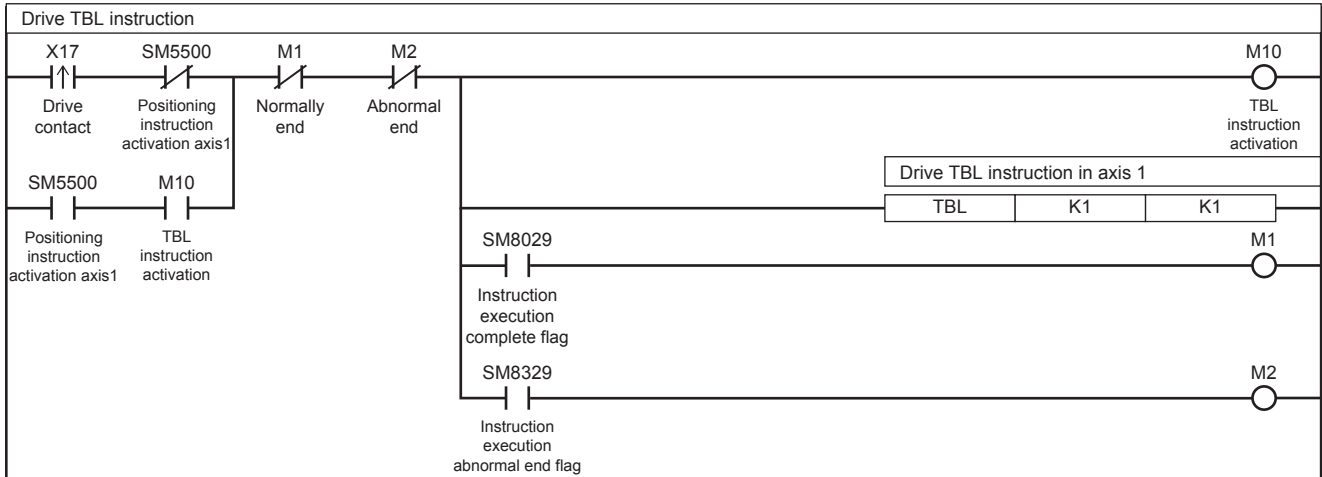

For the stop event, refer to [Page 462 Table transition variable speed operation](#).

## Simple linear interpolation operation (relative address specification)

The following is a program example of control method [20: Interpolation Operation (Relative Address Specification)] and [21: Interpolation Operation (Relative Address Specification Target Axis)].

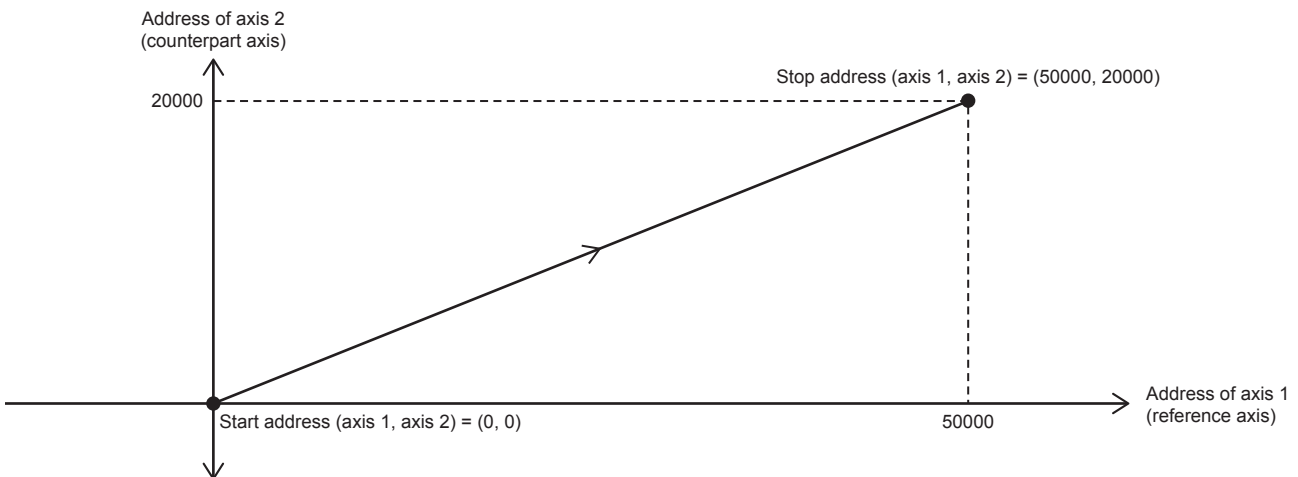

### ■ Axis 1 (reference axis)

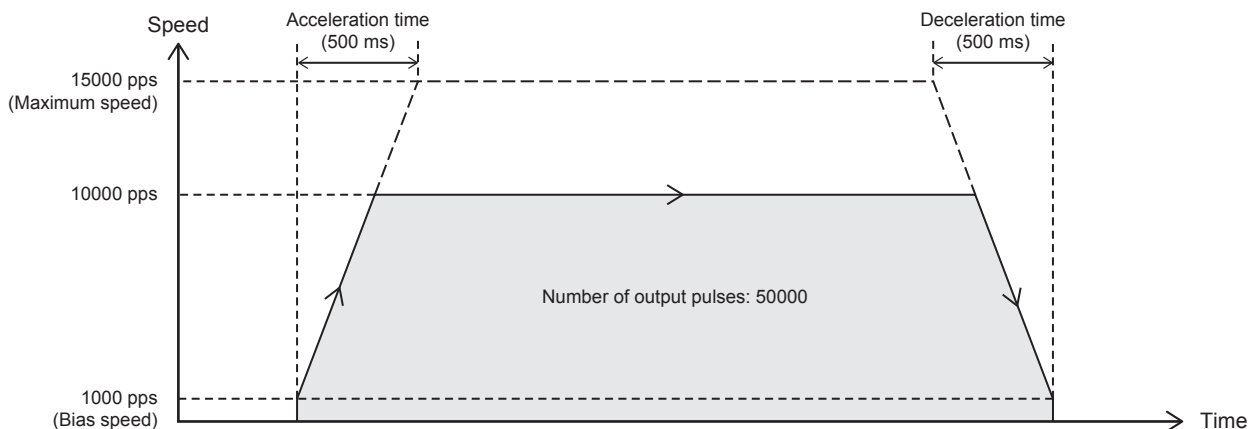

## ■Axis 2 (counterpart axis)

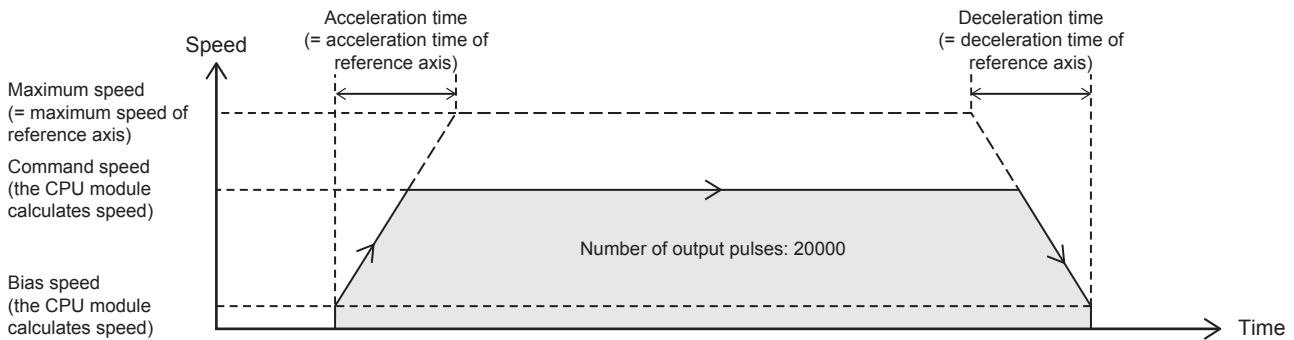

## Setting data

### ■Positioning parameter (high speed I/O parameter)

Item	Axis 1	Axis 2
<b>■Basic Parameter 1</b>		
Pulse Output Mode	1: PULSE/SIGN	1: PULSE/SIGN
Output Device (PULSE/CW)	Y0	Y1
Output Device (SIGN/CCW)	Y4	Y5
Rotation Direction Setting	0: Current Address Increment with Forward Run Pulse Output	0: Current Address Increment with Forward Run Pulse Output
Unit Setting	0: Motor System (pulse, pps)	0: Motor System (pulse, pps)
No. of Pulse per Rotation	2000 pulse	2000 pulse
Movement Amount per Rotation	1000 pulse	1000 pulse
Position Data Magnification	1: × Single	1: × Single
<b>■Basic Parameter 2</b>		
Interpolation Speed Specified Method	1: Reference Axis Speed	0: Composite Speed
Max. Speed	15000 pps	100000 pps
Bias Speed	1000 pps	0 pps
Acceleration Time	500 ms	100 ms
Deceleration Time	500 ms	100 ms
<b>■Detailed Setting Parameter</b>		
External Start Signal Enabled/ Disabled	0: Disabled	0: Disabled
Interrupt Input Signal 1 Enabled/ Disabled	0: Disabled	0: Disabled
Interrupt Input Signal 2 Logic	0: Positive Logic	0: Positive Logic
<b>■OPR Parameter</b>		
OPR Enabled/Disabled	0: Disabled	0: Disabled

### ■Axis #1 Positioning Data

No.	Device	Control Method	Axis to be Interpolated	Positioning Address	Command Speed	Dwell Time
1	—	20: Interpolation Operation (Relative Address Specification)	Axis 2 Specification	50000 pulse	10000 pps	100 ms

### ■Axis #2 Positioning Data

No.	Device	Control Method	Positioning Address
1	—	21: Interpolation Operation (Relative Address Specification Target Axis)	20000 pulse

## Program example

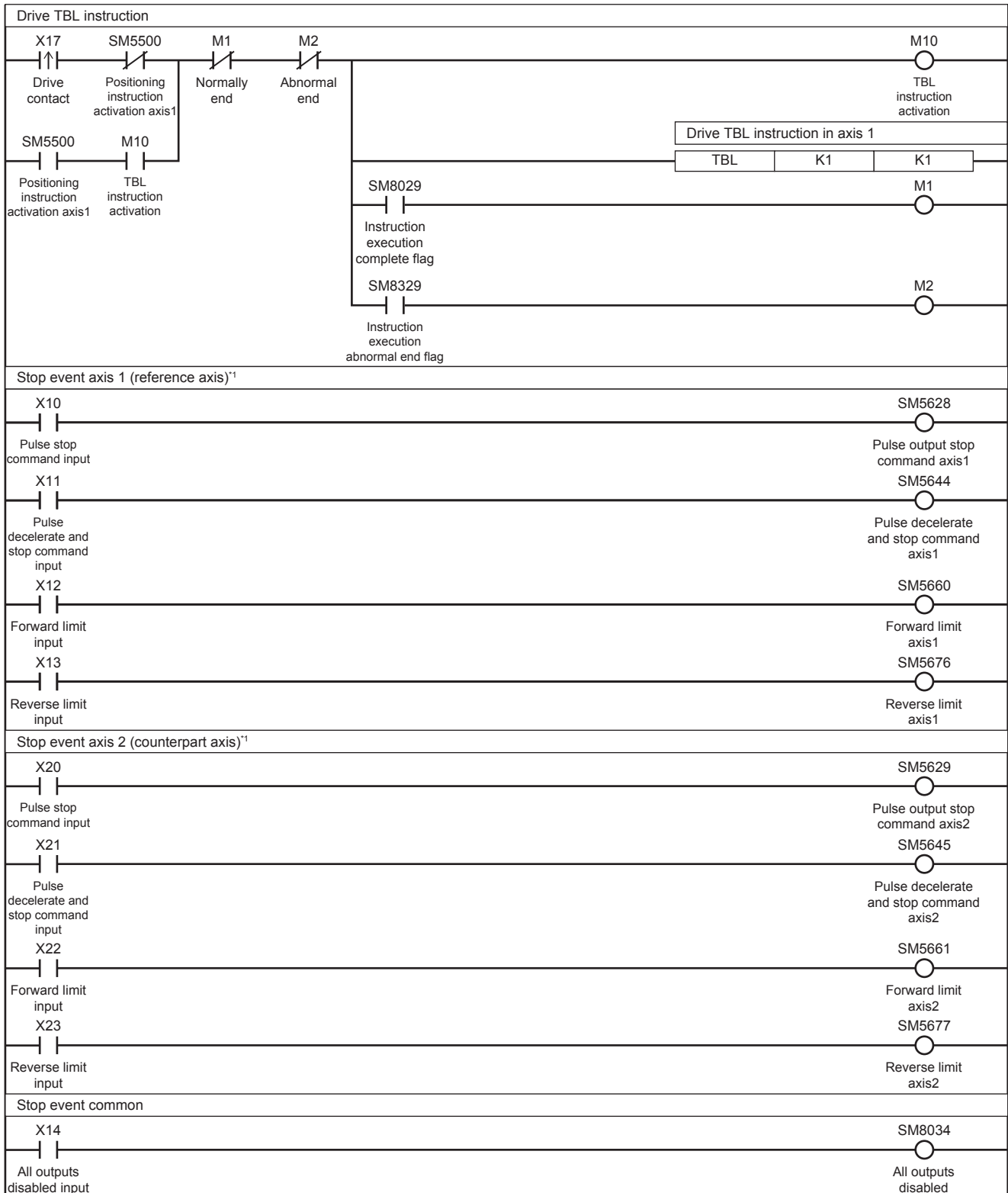

\*1 When stop event, is detected in either of the reference axis or counterpart axis, both the axes are stop.

## 32.9 Multiple-table Operation

This instruction executes the control method of multiple specified tables set in the table data with GX Works3.

### DRVTBL

This instruction executes the table data set in GX Works3 in continuous operation or stepping operation.

Ladder	ST	FBD/LD
	<pre>ENO:=DRVTBL(EN,n1,n2,n3,d1,d2);</pre>	

### Setting data

#### ■Description, range, data type

Operand	Description	Range	Data type	Data type (label)
(d1)	Axis number from which pulses are output	<ul style="list-style-type: none"> <li>■FX5S CPU module K1 to K4</li> <li>■FX5UJ CPU module K1 to K3, K5 to K12</li> <li>■FX5U/FX5UC CPU module K1 to K12</li> </ul>	16-bit unsigned binary	ANY16
(n1)	Head table number to be executed	1 to 100 <sup>*1</sup>	16-bit unsigned binary	ANY16_U
(n2)	Last table number to be executed	1 to 100 <sup>*1</sup>	16-bit unsigned binary	ANY16_U
(n3)	Table execution method	0, 1	16-bit unsigned binary	ANY16_U
(d2)	Bit device number of the instruction execution complete flag and abnormal end flag	—	Bit	ANYBIT_ARRAY (Number of elements:2)
EN	Execution condition	—	Bit	BOOL
ENO	Execution result	—	Bit	BOOL

\*1 CPU module is 1 to 32 when the positioning table data is not set to use device

#### ■Available device

Operand	Bit	Word			Double word		Indirect specification	Constant			Others
	X, Y, M, L, SM, F, B, SB, S	T, ST, C, D, W, SD, SW, R	U□\G□	Z	LC	LZ		K, H	E	\$	
(d1)	○	○	○	○	—	—	○	○	—	—	—
(n1)	○	○	○	○	—	—	○	○	—	—	—
(n2)	○	○	○	○	—	—	○	○	—	—	—
(n3)	○	○	○	○	—	—	○	○	—	—	—
(d2)	○	○ <sup>*1</sup>	—	—	—	—	—	—	—	—	—

\*1 T, ST, C cannot be used.

### Processing details

With one DRVTBL instruction, the table data set in GX Works3 can be executed in the continuous operation or stepping operation.

For details on the table setting method and others, refer to Page 487 TABLE OPERATION.

## Related devices

The following lists the related special devices. The devices other than the following depend on the table control method. Related devices of axis 4 are available only for the FX5S/FX5U/FX5UC CPU module.

### Special relays

#### ■CPU module

Axis 1	Axis 2	Axis 3	Axis 4	Name	High Speed I/O Parameter	R/W	Reference
SM5580	SM5581	SM5582	SM5583	Table shift command	×	R/W	Page 396
SM5916	SM5917	SM5918	SM5919	Positioning table data initialization disable	×	R/W	Page 397

R/W: Read/write, ×: Not supported

#### ■High-speed pulse input/output module

First module		Second module		Third module		Fourth module		Name	High Speed I/O Parameter	R/W	Reference
Axis 5	Axis 6	Axis 7	Axis 8	Axis 9	Axis 10	Axis 11	Axis 12				
SM5584	SM5585	SM5586	SM5587	SM5588	SM5589	SM5590	SM5591	Table shift command	×	R/W	Page 396
SM5920	SM5921	SM5922	SM5923	SM5924	SM5925	SM5926	SM5927	Positioning table data initialization disable	×	R/W	Page 397

R/W: Read/write, ×: Not supported

### Special registers

#### ■CPU module

Axis 1	Axis 2	Axis 3	Axis 4	Name	High Speed I/O Parameter	R/W	Reference
SD5506	SD5546	SD5586	SD5626	Positioning execution table number	×	R	Page 396
SD5511	SD5551	SD5591	SD5631	Positioning error (error occurrence table No.)	×	R/W	Page 397

R: Read only, R/W: Read/write, ×: Not supported

#### ■High-speed pulse input/output module

First module		Second module		Third module		Fourth module		Name	High Speed I/O Parameter	R/W	Reference
Axis 5	Axis 6	Axis 7	Axis 8	Axis 9	Axis 10	Axis 11	Axis 12				
SD5666	SD5706	SD5746	SD5786	SD5826	SD5866	SD5906	SD5946	Positioning execution table number	×	R	Page 396
SD5671	SD5711	SD5751	SD5791	SD5831	SD5871	SD5911	SD5951	Positioning error (error occurrence table No.)	×	R/W	Page 397

R: Read only, R/W: Read/write, ×: Not supported

# Outline of operation

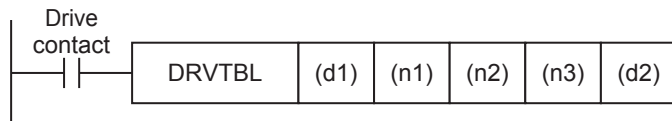

## Operand specification

**1.** For (d1), specify an axis number (K1 to K12) for which pulses are output.

Specify an axis number whose positioning parameters are set in the high speed I/O parameters. Operation cannot be performed if any other axis number is specified.

[FX5S CPU module]

- K1 to K4: Axis 1 to Axis 4

[FX5UJ CPU module]

- K1 to K3: Axis 1 to Axis 3 (CPU module)
- K5, K6: Axis 5, Axis 6 (High-speed pulse input/output module first module)
- K7, K8: Axis 7, Axis 8 (High-speed pulse input/output module second module)
- K9, K10: Axis 9, Axis 10 (High-speed pulse input/output module third module)
- K11, K12: Axis 11, Axis 12 (High-speed pulse input/output module fourth module)

[FX5U/FX5UC CPU module]

- K1 to K4: Axis 1 to Axis 4 (CPU module)
- K5, K6: Axis 5, Axis 6 (High-speed pulse input/output module first module)
- K7, K8: Axis 7, Axis 8 (High-speed pulse input/output module second module)
- K9, K10: Axis 9, Axis 10 (High-speed pulse input/output module third module)
- K11, K12: Axis 11, Axis 12 (High-speed pulse input/output module fourth module)

**2.** For (n1), specify the head table number (1 to 100<sup>\*1</sup>) that is executed in the axis specified in (d1).

**3.** For (n2), specify the last table number (1 to 100<sup>\*1</sup>) that is executed in the axis specified in (d1).

The table operation continues until the last table specified in (n2) or table of control method [0: No Positioning] is executed. When (n1) and (n2) are the same, only one table is executed. When (n1) is greater than (n2), the table operation continues either until all the tables are executed or until a table for control method [0: No Positioning] is executed.

**4.** For (n3), specify the table operation method.

- K0: The stepping operation ( [↩ Page 519 Stepping operation](#) )
- K1: The continuous operation ( [↩ Page 521 Continuous operation](#) )

**5.** For (d2), specify the bit devices of the instruction execution complete flag and abnormal end flag. ( [↩ Page 400 Complete flag](#) )

- (d2): Instruction execution complete flag
- (d2)+1: Instruction execution abnormal end flag

\*1 CPU module is 1 to 32 when the positioning table data is not set to use device

## Table shift command

In the stepping operation (K0 in (n3)), when the table shift command is detected after operation of a table is completed, the following table is activated. ( [↩ Page 396 Table shift command](#) ) Tables can be shifted with the external start signal. ( [↩ Page 383 External Start Signal](#) ) For details, refer to [↩ Page 519 Stepping operation](#).

## Operation of the complete flags

The operation timing of the complete flags depends on the table control method.



# Program example

The following are program examples for executing multiple tables.

## Stepping operation

This program example shows a stepping operation that is performed on axis 1 in order of control methods [1: 1 Speed Positioning (Relative Address Specification)], [5: Table Transition Variable Speed Operation], and [3: Interrupt 1 Speed Positioning].

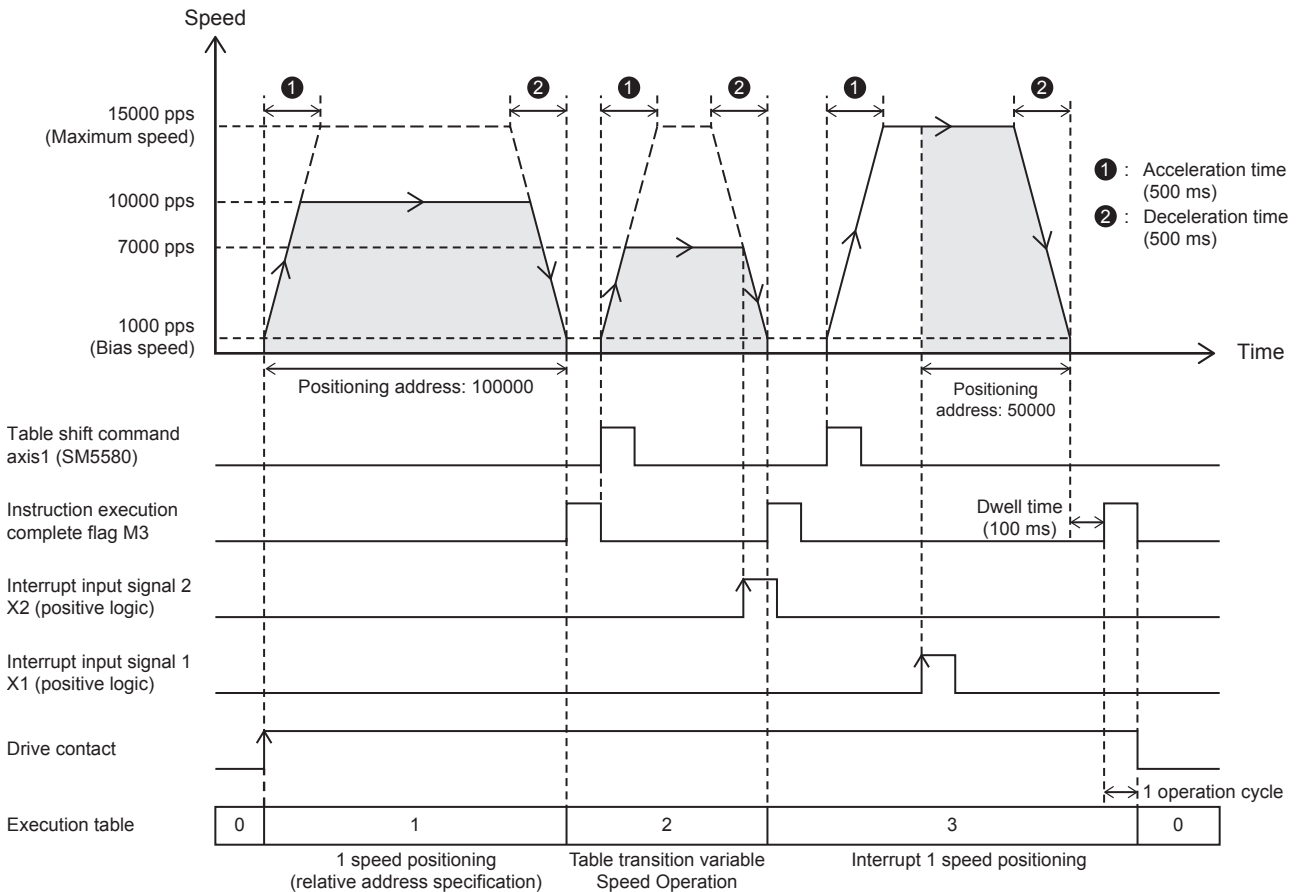

## Setting data

### Positioning parameter (high speed I/O parameter)

Item	Axis 1	Item	Axis 1
■Basic Parameter 1		■Basic Parameter 2	
Pulse Output Mode	1: PULSE/SIGN	Interpolation Speed Specified Method	0: Composite Speed
Output Device (PULSE/CW)	Y0	Max. Speed	15000 pps
Output Device (SIGN/CCW)	Y4	Bias Speed	1000 pps
Rotation Direction Setting	0: Current Address Increment with Forward Run Pulse Output	Acceleration Time	500 ms
Unit Setting	0: Motor System (pulse, pps)	Deceleration Time	500 ms
No. of Pulse per Rotation	2000 pulse	■Detailed Setting Parameter	
Movement Amount per Rotation	1000 pulse	External Start Signal Enabled/Disabled	0: Disabled
Positioning Data Magnification	1: × Single	Interrupt Input Signal 1 Enabled/Disabled	1: Enabled
—		Interrupt Input Signal 1 Mode	1: Standard Mode
		Interrupt Input Signal 1 Device No.	X1
		Interrupt Input Signal 1 Logic	0: Positive Logic
		Interrupt Input Signal 2 Logic	0: Positive Logic
		■OPR Parameter	
		OPR Enabled/Disabled	0: Disabled

## ■Axis #1 Positioning Data

No.	Device	Control Method	Positioning Address	Command Speed	Dwell Time	Interrupt Input Signal 2 Device No.
1	—	1: 1 Speed Positioning (Relative Address Specification)	100000 pulse	10000 pps	0 ms	—
2	—	5: Table Transition Variable Speed Operation	—	7000 pps	0 ms	X2
3	—	3: Interrupt 1 Speed Positioning	50000 pulse	15000 pps	100 ms	—

### Program example

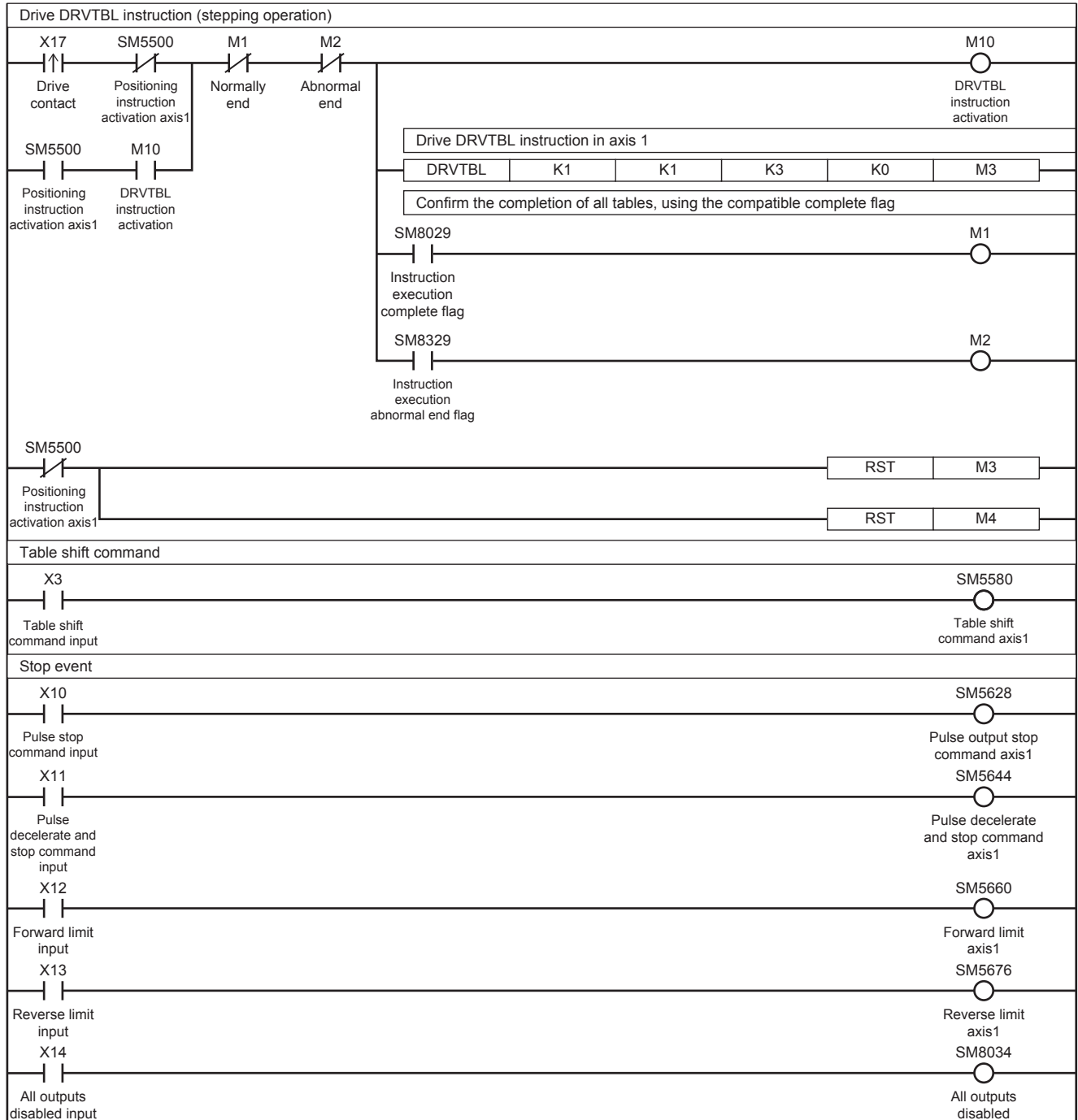

## Continuous operation

This program example shows a continuous operation (interrupt 2-speed positioning) that is performed on axis 1 in the order of control methods [5: Table Transition Variable Speed Operation] and [3: Interrupt 1 Speed Positioning], starting from table No. 2.

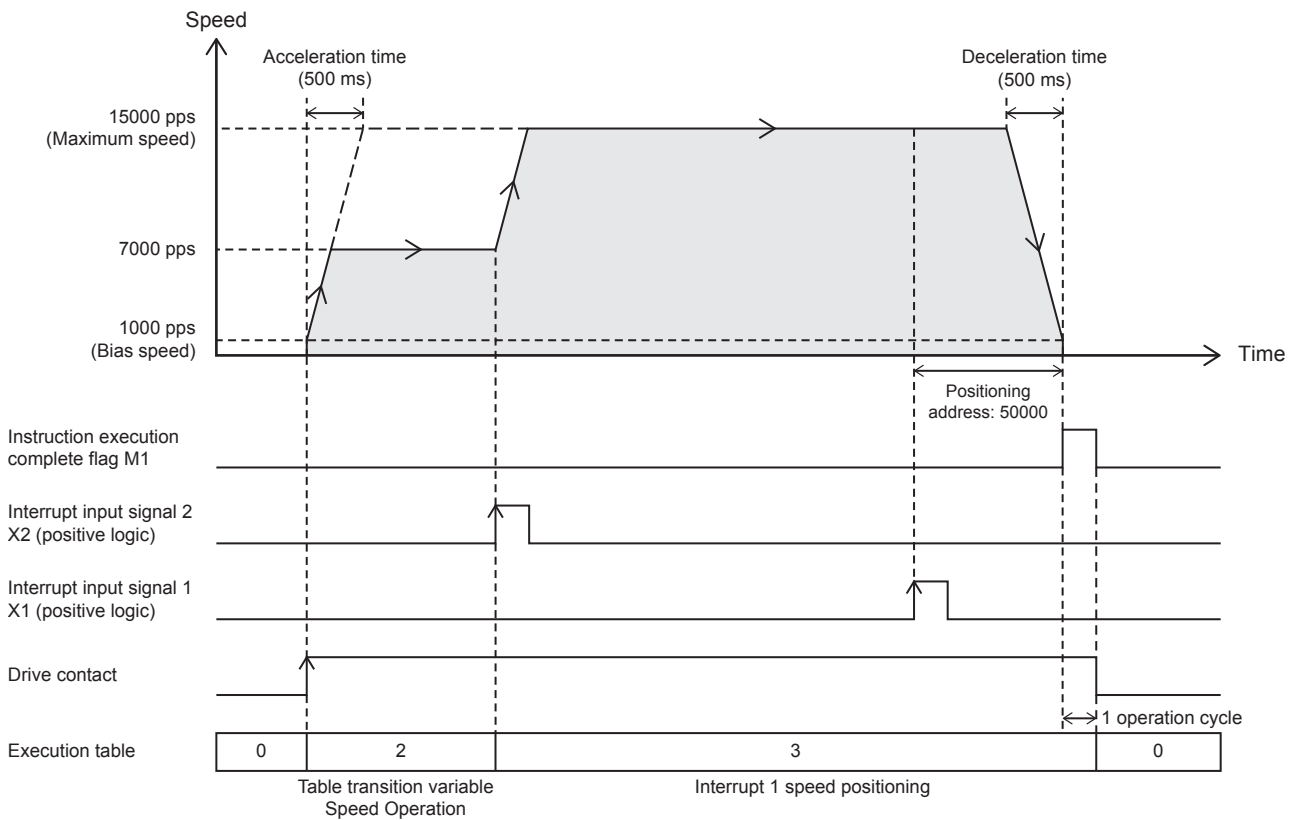

## Setting data

### Positioning parameter (high speed I/O parameter)

Item	Axis 1	Item	Axis 1
■Basic Parameter 1		■Basic Parameter 2	
Pulse Output Mode	1: PULSE/SIGN	Interpolation Speed Specified Method	0: Composite Speed
Output Device (PULSE/CW)	Y0	Max. Speed	15000 pps
Output Device (SIGN/CCW)	Y4	Bias Speed	1000 pps
Rotation Direction Setting	0: Current Address Increment with Forward Run Pulse Output	Acceleration Time	500 ms
Unit Setting	0: Motor System (pulse, pps)	Deceleration Time	500 ms
No. of Pulse per Rotation	2000 pulse	■Detailed Setting Parameter	
Movement Amount per Rotation	1000 pulse	External Start Signal Enabled/Disabled	0: Disabled
Positioning Data Magnification	1: × Single	Interrupt Input Signal 1 Enabled/Disabled	1: Enabled
—		Interrupt Input Signal 1 Mode	1: Standard Mode
		Interrupt Input Signal 1 Device No.	X1
		Interrupt Input Signal 1 Logic	0: Positive Logic
		Interrupt Input Signal 2 Logic	0: Positive Logic
		■OPR Parameter	
		OPR Enabled/Disabled	0: Disabled

## Axis #1 Positioning Data

No.	Device	Control Method	Positioning Address	Command Speed	Dwell Time	Interrupt Input Signal 2 Device No.
1	—	1: 1 Speed Positioning (Relative Address Specification)	100000 pulse	10000 pps	0 ms	—
2	—	5: Table Transition Variable Speed Operation	—	7000 pps	0 ms	X2
3	—	3: Interrupt 1 Speed Positioning	50000 pulse	15000 pps	0 ms	—

### Program example

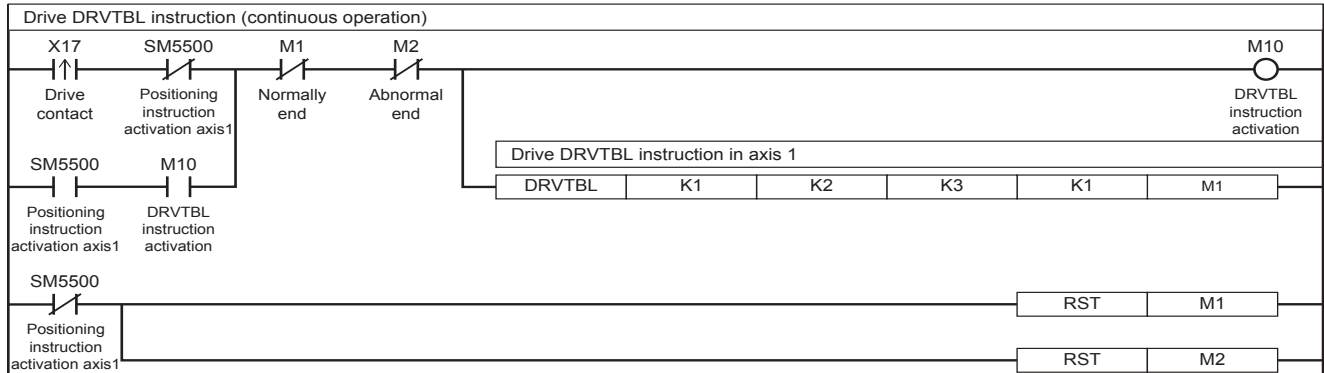

For the stop event, refer to Page 471 Stepping operation.

### Continuous operation (condition jump)

This program example shows the operation of a 2-speed positioning that is changed by the execution of control method [10: Condition Jump] on axis 1 (continuous operation).

#### M No. for jump condition (M100) = ON: Executes the table 5

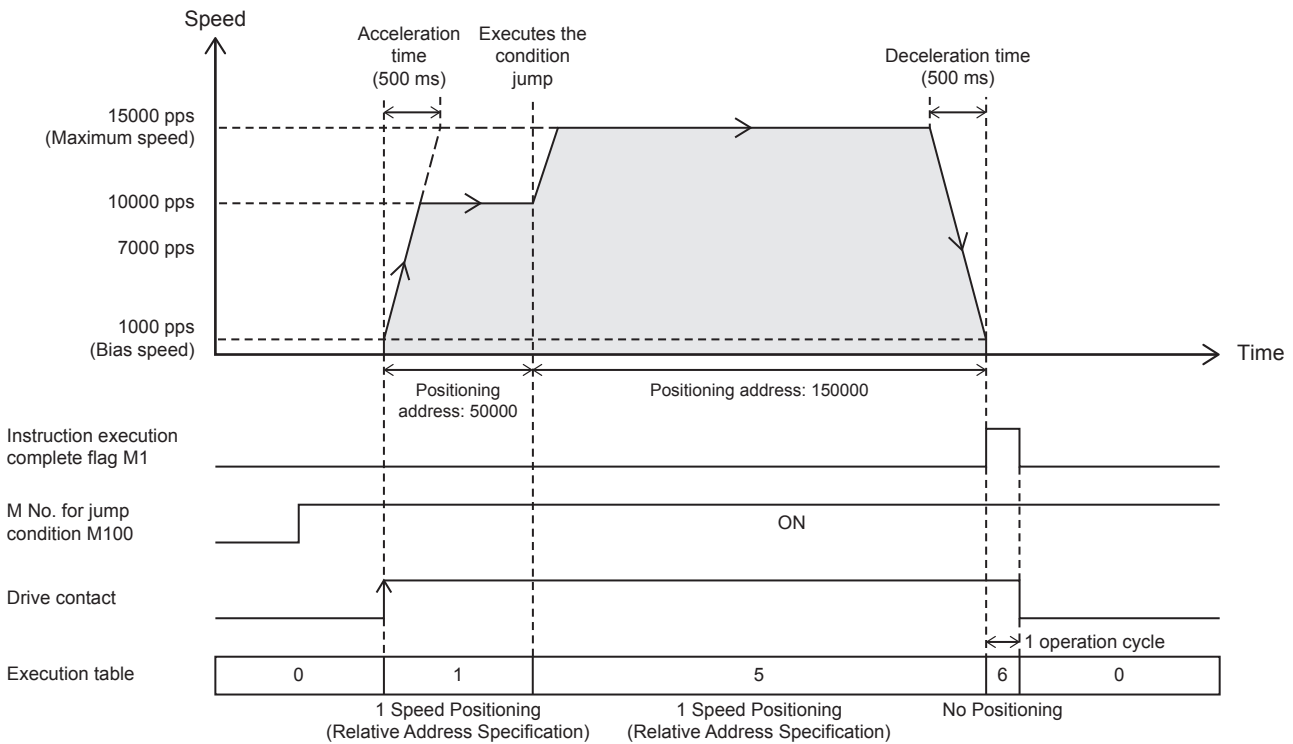

■M No. for jump condition (M100) = OFF: Executes the table 3

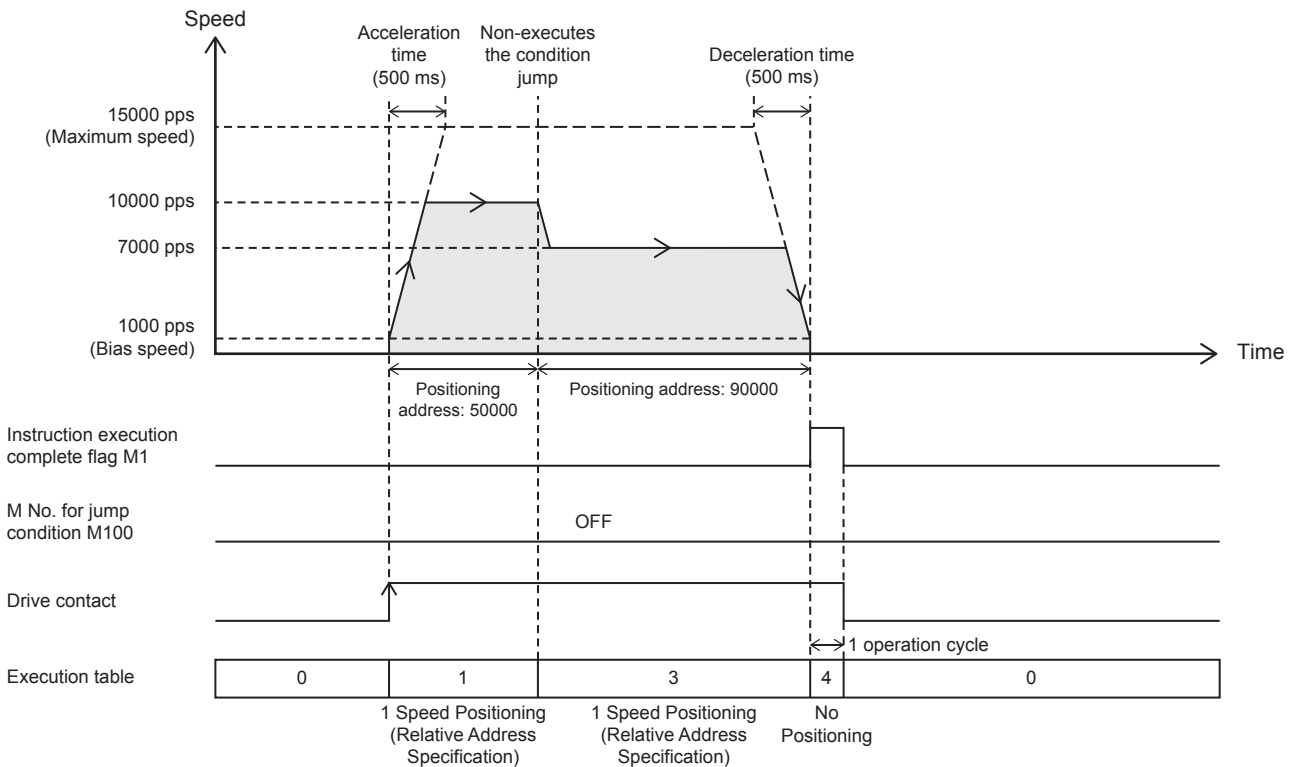

Setting data

■Positioning parameter (high speed I/O parameter)

Item	Axis 1	Item	Axis 1
■Basic Parameter 1		■Basic Parameter 2	
Pulse Output Mode	1: PULSE/SIGN	Interpolation Speed Specified Method	0: Composite Speed
Output Device (PULSE/CW)	Y0	Max. Speed	15000 pps
Output Device (SIGN/CCW)	Y4	Bias Speed	1000 pps
Rotation Direction Setting	0: Current Address Increment with Forward Run Pulse Output	Acceleration Time	500 ms
Unit Setting	0: Motor System (pulse, pps)	Deceleration Time	500 ms
No. of Pulse per Rotation	2000 pulse	■Detailed Setting Parameter	
Movement Amount per Rotation	1000 pulse	External Start Signal Enabled/Disabled	0: Disabled
Positioning Data Magnification	1: × Single	Interrupt Input Signal 1 Enabled/Disabled	0: Disabled
—		Interrupt Input Signal 2 Logic	0: Positive Logic
		■OPR Parameter	
		OPR Enabled/Disabled	0: Disabled

■Axis #1 Positioning Data

No.	Device	Control Method	Positioning Address	Command Speed	Dwell Time	Jump Destination Table No.	M No. for Jump Condition
1	—	1: 1 Speed Positioning (Relative Address Specification)	50000 pulse	10000 pps	0 ms	—	—
2	—	10: Condition Jump	—	—	—	5	100
3	—	1: 1 Speed Positioning (Relative Address Specification)	90000 pulse	7000 pps	0 ms	—	—
4	—	0: No Positioning	—	—	—	—	—
5	—	1: 1 Speed Positioning (Relative Address Specification)	150000 pulse	15000 pps	0 ms	—	—
6	—	0: No Positioning	—	—	—	—	—

## Program example

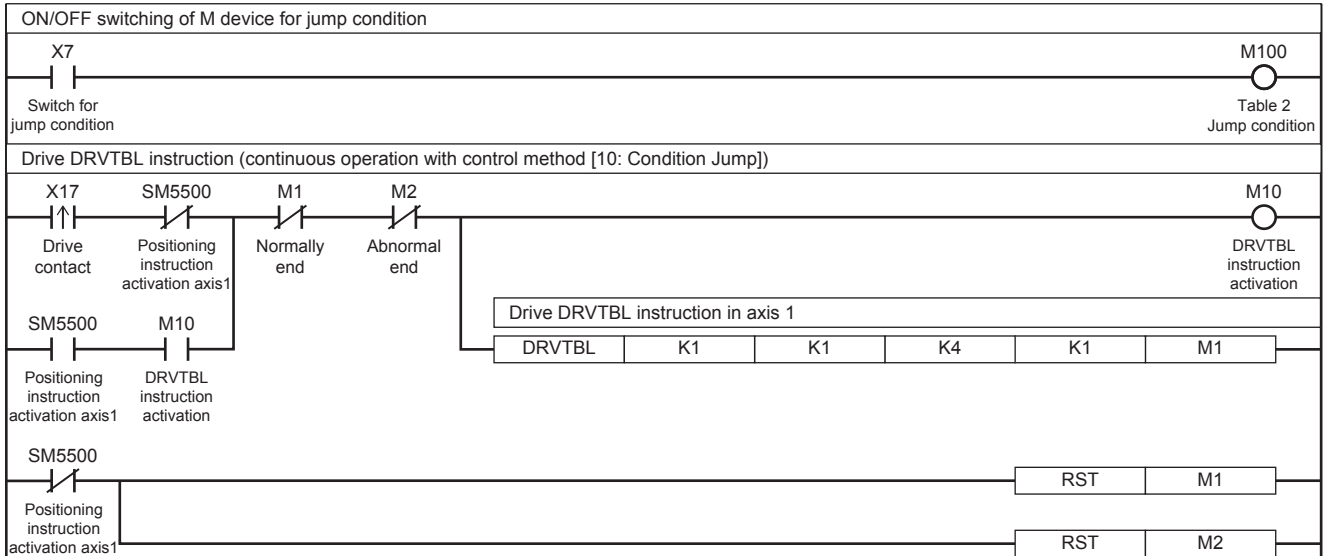

For the stop event, refer to [Page 471 Stepping operation](#).

## 32.10 Multiple-axis Table Operation

This instruction executes the control method of specified table for multiple axes set in the table data with GX Works3.

### DRVMUL

This instruction executes the table data set in GX Works3 for multiple axes of one module simultaneously.

Ladder	ST	FBD/LD
	<pre>ENO:=DRVMUL(EN,n1,n2,n3,n4,n5,d);</pre>	

## Setting data

### ■Description, range, data type

Operand	Description	Range	Data type	Data type (label)
(n1)	Head axis number	<ul style="list-style-type: none"> <li>■FX5S CPU module K1</li> <li>■FX5UJ/FX5U/FX5UC CPU module K1, K5, K7, K9, K11</li> </ul>	16-bit unsigned binary	ANY16_U
(n2)	Table number of the axis 1	0 to 100 <sup>*1</sup>	16-bit unsigned binary	ANY16_U
(n3)	Table number of the axis 2	0 to 100 <sup>*1</sup>	16-bit unsigned binary	ANY16_U
(n4)	Table number of the axis 3	0 to 100 <sup>*1</sup>	16-bit unsigned binary	ANY16_U
(n5)	Table number of the axis 4	0 to 100 <sup>*1</sup>	16-bit unsigned binary	ANY16_U
(d)	Bit device number of the instruction execution complete flag and abnormal end flag	—	Bit	ANYBIT_ARRAY (Number of elements:8)
EN	Execution condition	—	Bit	BOOL
ENO	Execution result	—	Bit	BOOL

\*1 CPU module is 1 to 32 when the positioning table data is not set to use device

### ■Available device

Operand	Bit	Word			Double word		Indirect specification	Constant			Others
	X, Y, M, L, SM, F, B, SB, S	T, ST, C, D, W, SD, SW, R	U□\G□	Z	LC	LZ		K, H	E	\$	
(n1)	○	○	○	○	—	—	○	○	—	—	—
(n2)	○	○	○	○	—	—	○	○	—	—	—
(n3)	○	○	○	○	—	—	○	○	—	—	—
(n4)	○	○	○	○	—	—	○	○	—	—	—
(n5)	○	○	○	○	—	—	○	○	—	—	—
(d)	○	○ <sup>*1</sup>	—	—	—	—	—	—	—	—	—

\*1 T, ST, C cannot be used.

## Processing details

This function executes the tables of multiple axes of simultaneously. After this function is executed, each axis operates independently and continuous operation can be performed. However, simultaneous execution is possible only for axes in the same module.

For details on the table setting method and others, refer to  Page 487 TABLE OPERATION.

## Related devices

The following lists the related special devices. The devices other than the following depend on the table control method. Related devices of axis 4 are available only for the FX5S/FX5U/FX5UC CPU module.

### Special relays

#### ■CPU module

Axis 1	Axis 2	Axis 3	Axis 4	Name	High Speed I/O Parameter	R/W	Reference
SM5916	SM5917	SM5918	SM5919	Positioning table data initialization disable	×	R/W	Page 397

R/W: Read/write, ×: Not supported

## High-speed pulse input/output module

First module		Second module		Third module		Fourth module		Name	High Speed I/O Parameter	R/W	Reference
Axis 5	Axis 6	Axis 7	Axis 8	Axis 9	Axis 10	Axis 11	Axis 12				
SM5920	SM5921	SM5922	SM5923	SM5924	SM5925	SM5926	SM5927	Positioning table data initialization disable	×	R/W	Page 397

R/W: Read/write, ×: Not supported

## Special registers

### CPU module

Axis 1	Axis 2	Axis 3	Axis 4	Name	High Speed I/O Parameter	R/W	Reference
SD5506	SD5546	SD5586	SD5626	Positioning execution table number	×	R	Page 396
SD5511	SD5551	SD5591	SD5631	Positioning error (error occurrence table No.)	×	R/W	Page 397

R: Read only, R/W: Read/write, ×: Not supported

### High-speed pulse input/output module

First module		Second module		Third module		Fourth module		Name	High Speed I/O Parameter	R/W	Reference
Axis 5	Axis 6	Axis 7	Axis 8	Axis 9	Axis 10	Axis 11	Axis 12				
SD5666	SD5706	SD5746	SD5786	SD5826	SD5866	SD5906	SD5946	Positioning execution table number	×	R	Page 396
SD5671	SD5711	SD5751	SD5791	SD5831	SD5871	SD5911	SD5951	Positioning error (error occurrence table No.)	×	R/W	Page 397

R: Read only, R/W: Read/write, ×: Not supported

## Outline of operation

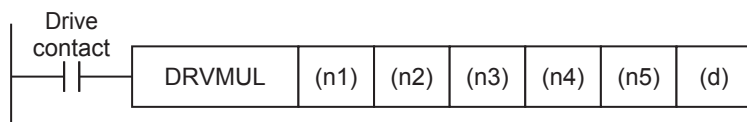

## Operand specification

**1.** For (n1), specify the head axis number for which pulses are output.

[FX5S CPU module]

- K1: Axis 1 (The tables of axes 1 to 4 are simultaneously executed.)

[FX5UJ CPU module]

- K1: Axis 1 (The tables of axes 1 to 3 are simultaneously executed.)
- K5: Axis 5 (The tables of axes 5 and 6 (High-speed pulse input/output module first module) are simultaneously executed.)
- K7: Axis 7 (The tables of axes 7 and 8 (High-speed pulse input/output module second module) are simultaneously executed.)
- K9: Axis 9 (The tables of axes 9 and 10 (High-speed pulse input/output module third module) are simultaneously executed.)
- K11: Axis 11 (The tables of axes 11 and 12 (High-speed pulse input/output module fourth module) are simultaneously executed.)

[FX5U/FX5UC CPU module]

- K1: Axis 1 (The tables of axes 1 to 4 are simultaneously executed.)
- K5: Axis 5 (The tables of axes 5 and 6 (High-speed pulse input/output module first module) are simultaneously executed.)
- K7: Axis 7 (The tables of axes 7 and 8 (High-speed pulse input/output module second module) are simultaneously executed.)
- K9: Axis 9 (The tables of axes 9 and 10 (High-speed pulse input/output module third module) are simultaneously executed.)
- K11: Axis 11 (The tables of axes 11 and 12 (High-speed pulse input/output module fourth module) are simultaneously executed.)



**2.** For (n2), specify the head table number (1 to 100\*1) that is executed in the axis specified in (n1).

When the positioning instruction of the axis (n1) is not to be executed or positioning parameters of the axis (n1) are not set for high speed I/O parameter, specify K0. When (n2) is indirectly specified using a word device, continuous operation is performed. (Page 521 Continuous operation) The specified word devices are assigned as follows.

- Device specified in (n2): Head table number
- Device specified in (n2) + 1: Last table number

**3.** For (n3), specify the head table number (1 to 100\*1) that is executed in the axis specified in (n1) + 1.

When the positioning instruction of the axis (n1) + 1 is not to be executed or positioning parameters of the axis (n1) + 1 are not set for high speed I/O parameter, specify K0. When (n3) is indirectly specified using a word device, continuous operation is performed. The specified word devices are assigned as follows.

- Device specified in (n3): Head table number
- Device specified in (n3) + 1: Last table number

**4.** For (n4), specify the head table number (1 to 100\*1) that is executed in the axis specified in (n1) + 2.

When the positioning instruction of the axis (n1) + 2 is not to be executed, positioning parameters of the axis (n1) + 2 are not set for high speed I/O parameter, or high-speed pulse input/output module ((n1) = K5, K7, K9, K11) are used, specify K0. When (n4) is indirectly specified using a word device, continuous operation is performed. The specified word devices are assigned as follows.

- Device specified in (n4): Head table number
- Device specified in (n4) + 1: Last table number

**5.** For (n5), specify the head table number (1 to 100\*1) that is executed in the axis specified in (n1) + 3.

When the positioning instruction of the axis (n1) + 3 is not to be executed, positioning parameters of the axis (n1) + 3 are not set for high speed I/O parameter, FX5UJ CPU module ((n1) = K1) or high-speed pulse input/output module ((n1) = K5, K7, K9, K11) are used, specify K0. When (n5) is indirectly specified using a word device, continuous operation is performed. The specified word devices are assigned as follows.

- Device specified in (n5): Head table number
- Device specified in (n5) + 1: Last table number

**6.** For (d), specify the bit devices of the instruction execution complete flag and abnormal end flag of each axis. The device assignment is as follows. (Page 400 Complete flag)

- (d): Instruction execution complete flag of (n1)
- (d)+1: Instruction execution abnormal end flag of (n1)
- (d)+2: Instruction execution complete flag of (n1)+1
- (d)+3: Instruction execution abnormal end flag of (n1)+1
- (d)+4: Instruction execution complete flag of (n1)+2\*2
- (d)+5: Instruction execution abnormal end flag of (n1)+2\*2
- (d)+6: Instruction execution complete flag of (n1)+3\*3
- (d)+7: Instruction execution abnormal end flag of (n1)+3\*3

\*1 CPU module is 1 to 32 when the positioning table data is not set to use device

\*2 The complete flag is assigned only in CPU module.

\*3 The complete flag or end flag is assigned only in FX5S/FX5U/FX5UC CPU module.

## When the interpolation operation table is specified

When interpolation operation is specified by the DRVMUL instruction, specify the table number only for the reference axis and set the table number of the counterpart axis to 0.

An error occurs otherwise.

## External start signal

The external start signal of the axis with the smallest number that satisfies the following conditions is enabled. When the external start signal of an axis is enabled, the external start signal of the other axes with larger numbers are disabled.

- External start signal is enabled.
- Table number with the axis specified is executed. (If pulses are not output in the table setting, the external start signal is disabled.)

## Operation of the complete flags

The operation timing of the complete flags depends on the table control method.

The FX3 compatible devices (SM8029 and SM8329) cannot be used.

## Program example

The following is the program example of FX5S/FX5U/FX5UC CPU module that executes each operation of axes 1, 2, and 4 simultaneously.

### ■Axis 1 (Interrupt 2-speed positioning)

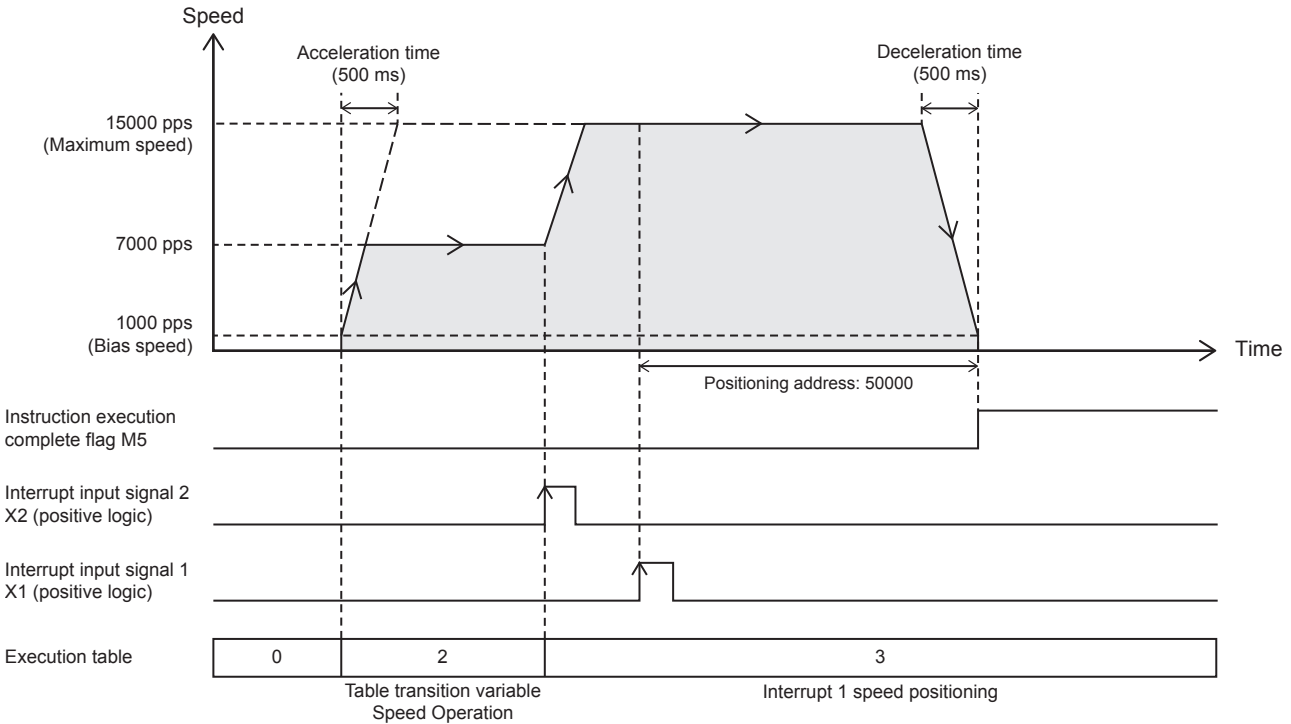

### ■Axis 2 (4-speed positioning)

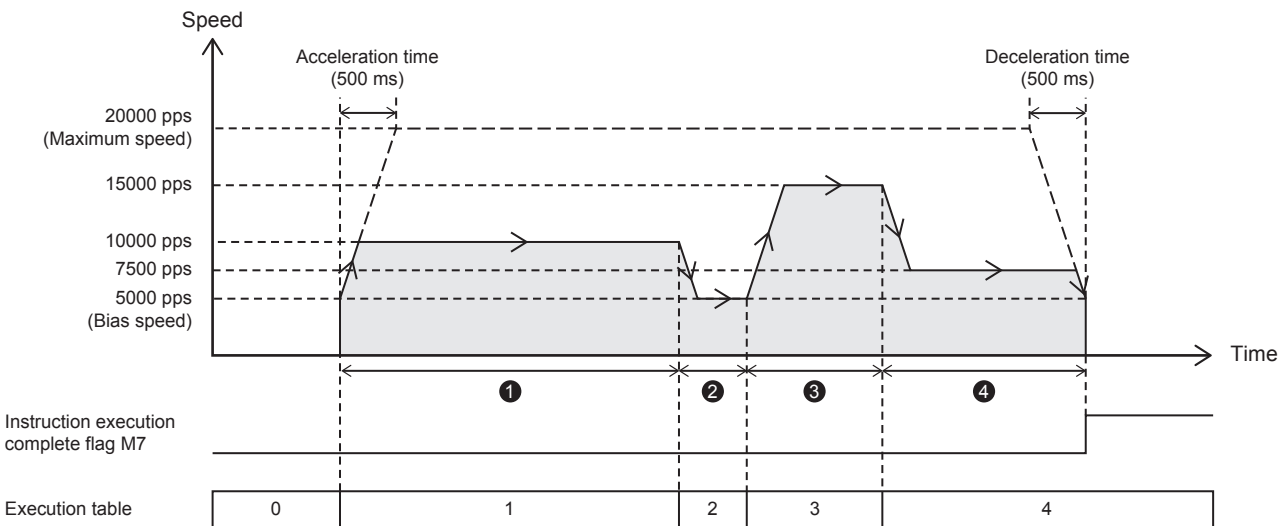

- ① Control method [1: 1 Speed Positioning (Relative Address Specification)], positioning address: 50000
- ② Control method [2: 1 Speed Positioning (Absolute Address Specification)], positioning address: 60000 (output only +10000)
- ③ Control method [1: 1 Speed Positioning (Relative Address Specification)], positioning address: 20000
- ④ Control method [1: 1 Speed Positioning (Relative Address Specification)], positioning address: 30000

### ■Axis 4 (1-speed positioning)

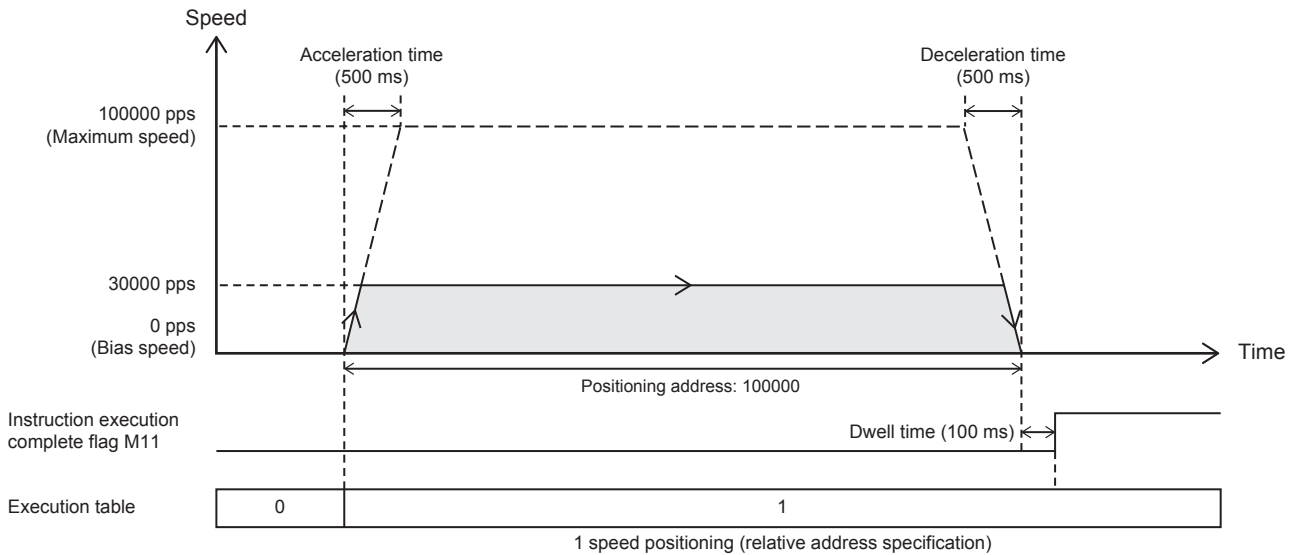

## Setting data

### ■Positioning parameter (high speed I/O parameter)

Item	Axis 1	Axis 2	Axis 4
<b>■Basic Parameter 1</b>			
Pulse Output Mode	1: PULSE/SIGN	1: PULSE/SIGN	1: PULSE/SIGN
Output Device (PULSE/CW)	Y0	Y1	Y3
Output Device (SIGN/CCW)	Y4	Y5	Y7
Rotation Direction Setting	0: Current Address Increment with Forward Run Pulse Output	0: Current Address Increment with Forward Run Pulse Output	0: Current Address Increment with Forward Run Pulse Output
Unit Setting	0: Motor System (pulse, pps)	0: Motor System (pulse, pps)	0: Motor System (pulse, pps)
No. of Pulse per Rotation	2000 pulse	2000 pulse	2000 pulse
Movement Amount per Rotation	1000 pulse	1000 pulse	1000 pulse
Position Data Magnification	1: × Single	1: × Single	1: × Single
<b>■Basic Parameter 2</b>			
Interpolation Speed Specified Method	0: Composite Speed	0: Composite Speed	0: Composite Speed
Max. Speed	15000 pps	20000 pps	100000 pps
Bias Speed	1000 pps	5000 pps	0 pps
Acceleration Time	500 ms	500 ms	500 ms
Deceleration Time	500 ms	500 ms	500 ms
<b>■Detailed Setting Parameter</b>			
External Start Signal Enabled/ Disabled	0: Disabled	0: Disabled	0: Disabled
Interrupt Input Signal 1 Enabled/ Disabled	1: Enabled	0: Disabled	0: Disabled
Interrupt Input Signal 1 Mode	1: Standard Mode	—	—
Interrupt Input Signal 1 Device No.	X1	—	—
Interrupt Input Signal 1 Logic	0: Positive Logic	—	—
Interrupt Input Signal 2 Logic	0: Positive Logic	0: Positive Logic	0: Positive Logic
<b>■OPR Parameter</b>			
OPR Enabled/Disabled	0: Disabled	0: Disabled	0: Disabled

## ■Axis #1 Positioning Data

No.	Device	Control Method	Positioning Address	Command Speed	Dwell Time	Interrupt Input Signal 2 Device No.
1	—	1: 1 Speed Positioning (Relative Address Specification)	100000 pulse	10000 pps	0 ms	—
2	—	5: Table Transition Variable Speed Operation	—	7000 pps	0 ms	X2
3	—	3: Interrupt 1 Speed Positioning	50000 pulse	15000 pps	0 ms	—

## ■Axis #2 Positioning Data

No.	Device	Control Method	Positioning Address	Command Speed	Dwell Time
1	—	1: 1 Speed Positioning (Relative Address Specification)	50000 pulse	10000 pps	0 ms
2	—	2: 1 Speed Positioning (Absolute Address Specification)	60000 pulse	5000 pps	0 ms
3	—	1: 1 Speed Positioning (Relative Address Specification)	20000 pulse	15000 pps	0 ms
4	—	1: 1 Speed Positioning (Relative Address Specification)	30000 pulse	7500 pps	0 ms

## ■Axis #4 Positioning Data

No.	Device	Control Method	Positioning Address	Command Speed	Dwell Time
1	—	2: 1 Speed Positioning (Absolute Address Specification)	100000 pulse	30000 pps	100 ms

## Program example

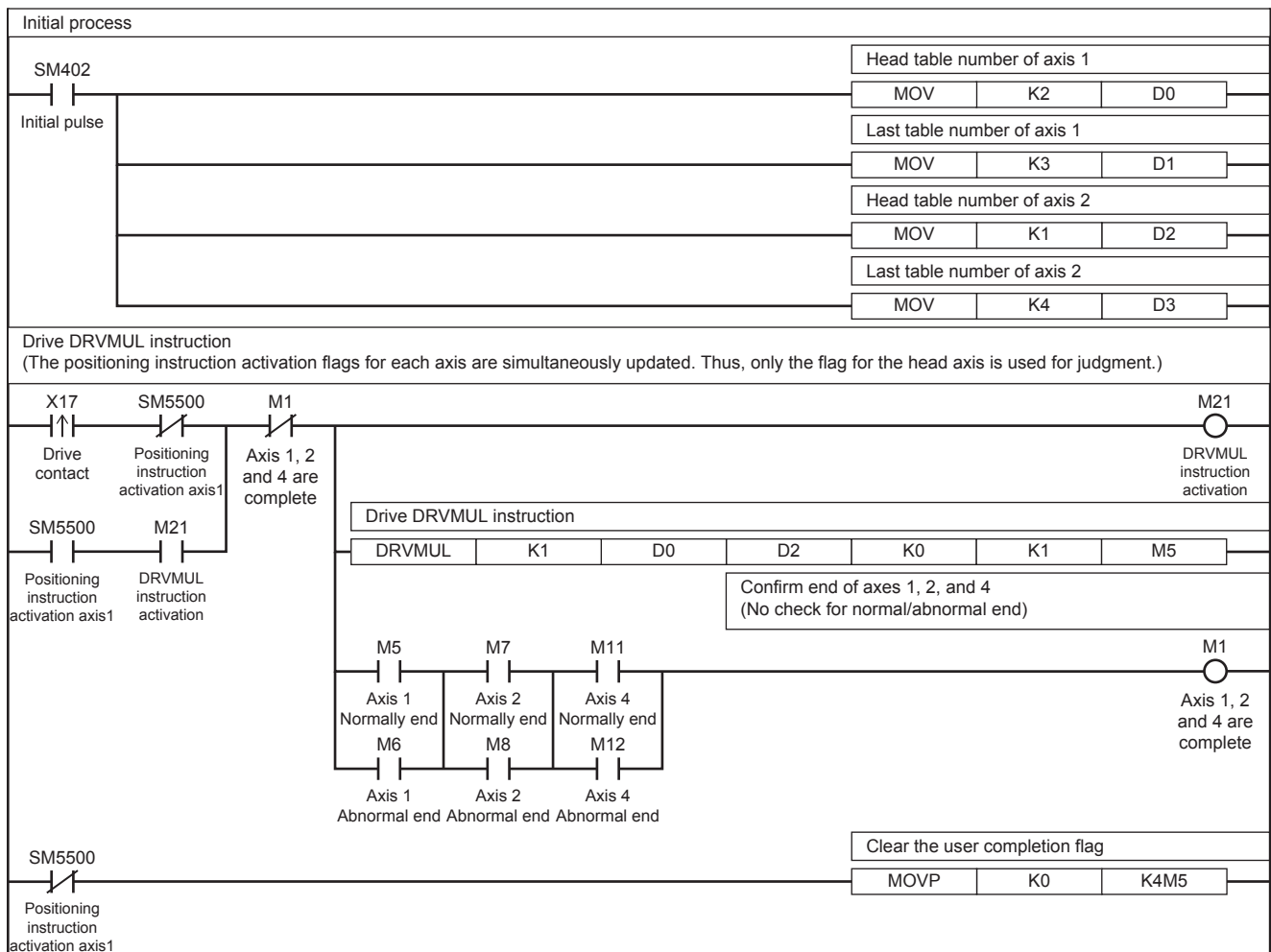

# 32.11 Absolute Position Detection System

With the use of the servo absolute position detection system, the positioning uses the current ABS value read-out (DABS) instruction to read out the current value (absolute position (ABS) data) from the MR-J4□A or MR-J3□A servo amplifier. The data is converted into pulse when being read.

## DABS

This instruction reads the absolute position (ABS) data when the servo amplifier is connected. The data is converted into pulse when being read.

Ladder	ST	FBD/LD
	ENO:=DABS(EN,s,d1,d2);	

## Setting data

### ■Description, range, data type

Operand	Description	Range	Data type	Data type (label)
(s)	First number of the device that inputs the output signal for the absolute position (ABS) data from the servo amplifier	—	Bit	ANYBIT_ARRAY (Number of elements:3)
(d1)	First number of the device that outputs the absolute position (ABS) data control signal to the servo amplifier	—	Bit	ANYBIT_ARRAY (Number of elements:3)
(d2)	Absolute position (ABS) data (32-bit value) storage device number	—	32-bit signed binary	ANY32
EN	Execution condition	—	Bit	BOOL
ENO	Execution result	—	Bit	BOOL

### ■Available device

Operand	Bit	Word			Double word		Indirect specification	Constant			Others
	X, Y, M, L, SM, F, B, SB, S	T, ST, C, D, W, SD, SW, R	U□\G□	Z	LC	LZ		K, H	E	\$	
(s)	○	○*1	—	—	—	—	—	—	—	—	—
(d1)	○	○*1	—	—	—	—	—	—	—	—	—
(d2)	○	○	○	—	○	○	○	○	—	—	—

\*1 T, ST, C cannot be used.

## Processing details

This instruction reads the absolute position (ABS) data when the servo amplifier is connected. The data is converted into pulse when being read.

## Related devices

The following lists the related special devices.

FX3 compatible	Name	High Speed I/O Parameter	R/W	Reference
SM8029	Instruction execution complete flag	×	R	Page 400
SM8329	Instruction execution abnormal end flag	×	R	

R: Read only, ×: Not supported

# Outline of operation

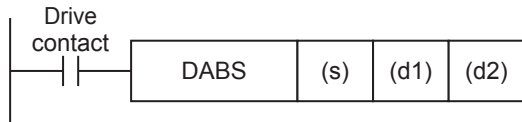

## Operand specification

- For (s), specify the first number of the device that inputs the output signal for ABS data from the servo amplifier. The device assignment is as follows.
  - (s): ABS (bit 0)
  - (s)+1: ABS (bit 1)
  - (s)+2: "Send data ready" signal
- For (d1), specify the first number of the device that outputs the ABS data control signal to the servo amplifier. The device assignment is as follows.
  - (d1): Servo-ON signal
  - (d1)+1: "ABS data transfer mode" signal
  - (d1)+2: ABS request signal
- For (d2), specify the number of the device that stores the ABS data (-2147483648 to +2147483647 in pulses) read from the servo amplifier.

Always specify a data register as the specified device. After that, transfer the ABS data from the data register in which the ABS data is stored to the current address (pulse unit) by the HCMOV/DHCMOV instruction.

## Detection of absolute position

- If the DABS instruction turns ON, the CPU module will activate the servo-ON output and the ABS transfer mode output.
- 32+6-bit data communication will be performed while mutually checking the data sending/receiving condition using the "send data ready" signal and the "ABS data request" signal.
- The 2-bit line (line for ABS bit 0 and bit 1) will be used for data transmission.
- At the completion of ABS data read, the "Execution complete" flag will turn on.

Example of MR-J4□A

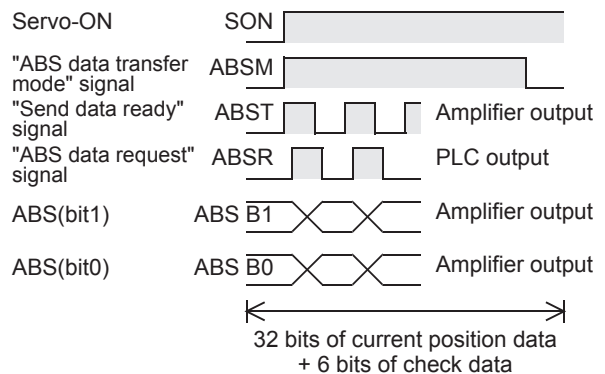

### Point

Up to 16 DABS instructions can be driven simultaneously.

## Initial OPR

When your system is established, even if your servo motor is equipped with an absolute position detection function, it is necessary to perform OPR at least once to send the clear signal to the servo motor.

Use one of the following methods for the initial OPR:

- Enable the clear signal function using the DSZR/DDSZR instruction, and perform OPR. (☞ Page 411 Mechanical OPR, Page 389 Clear Signal Output)
- Carry out OPR for the machine using the position adjustment method in the jogging operation mode or manual operation mode, and then input the clear signal. To input the clear signal to the servo amplifier, use the output of the PLC or the external switch shown in the following figure.

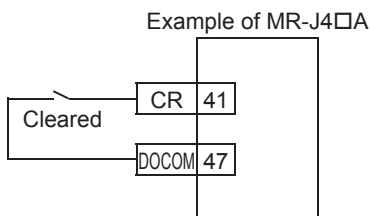

## Operation of the complete flags

The following describes the operation timings of the complete flags.

Item	FX3 compatible	
	Instruction execution complete flag (SM8029)	Instruction execution abnormal end flag (SM8329)
ON condition	When ABS data has been normally read from the servo amplifier	From when the following error occurs to when the error cause is eliminated and the drive contact is turned off <ul style="list-style-type: none"> <li>• The three specified devices cannot be secured.</li> <li>• Sum error of the ABS data read from the servo amplifier</li> <li>• Upper limit on the number of ABS instructions simultaneously executed</li> </ul>
ON → OFF condition	When the drive contact is turned off	

## Program example

The following is a program example of reading the current ABS value.

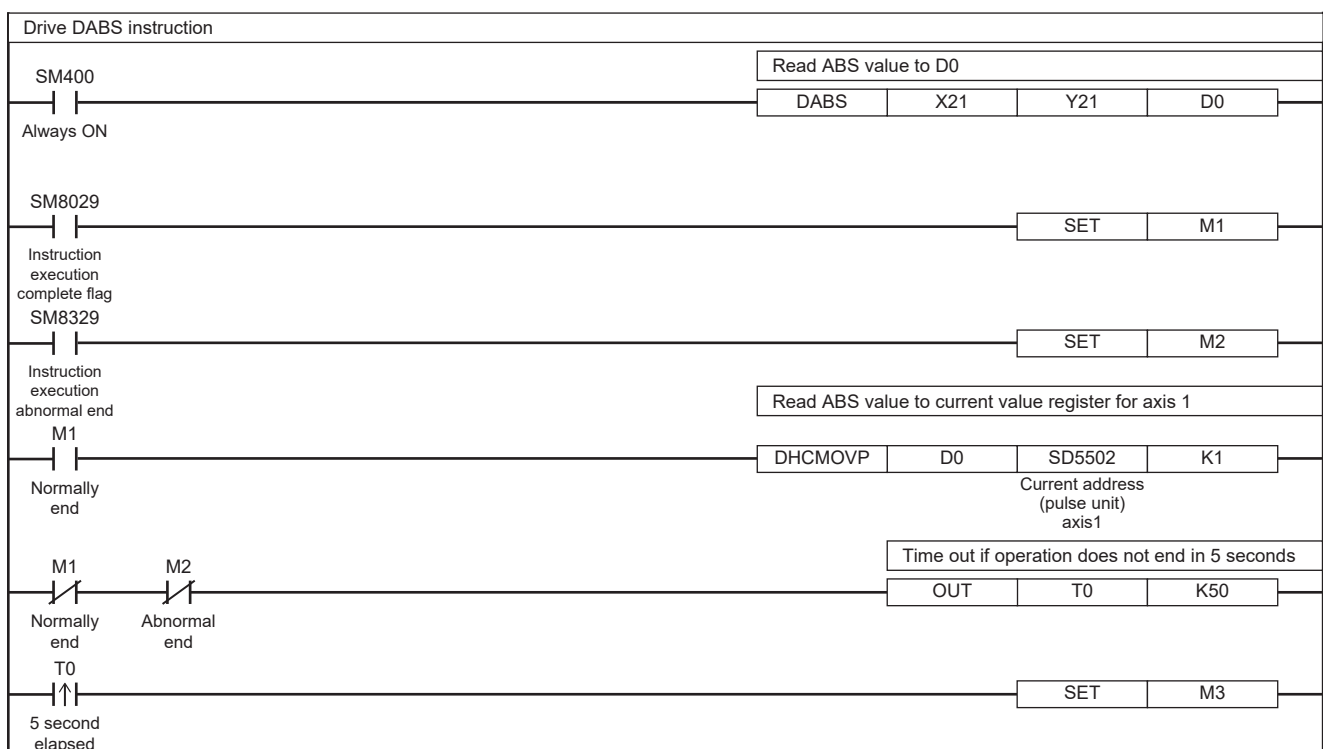

## Caution

For details on the servo amplifier, refer to the manual for each servo amplifier.

- Set the timing sequence for powering on your system so that the power of the PLC is turned on after the power of the servo amplifier, or that power is turned on at the same time.
- Leave the drive contact ON after read the ABS value. If the instruction drive contact is turned off at the completion of ABS data read, the servo-ON (SON) signal will be turned off, and the operation will not be performed.
- If the drive contact is turned off during data reading, data reading will be stopped.
- If data communication with the servo amplifier fails, the failure is not detected as an error. Thus, monitor the error using the time-out error detection timer.
- When using the DABS instruction, set the rotation direction of the servo motor as follows. If the setting is incorrect, the current value controlled by the PLC may not match with the sign (positive or negative) in the servo amplifier after the ABS value is read.

Rotation direction	Setting in servo amplifier
Current value is increased by forward rotation pulses	Forward rotation (CCW) when forward rotation pulses are input Reverse rotation (CW) when reverse rotation pulses are input
Current value is decreased by reverse rotation pulses	Forward rotation (CW) when reverse rotation pulses are input Reverse rotation (CCW) when forward rotation pulses are input



# 33 TABLE OPERATION

This chapter describes the table operation in the following items.

- How to use the positioning table in GX Works3
- Operations of each control method
- How to execute multiple tables (stepping operation and continuous operation)

## 33.1 How to Use the Positioning Table

The following procedure is required to perform positioning in table operation.

1. Set the positioning parameter in the high speed I/O parameter of GX Works3. (Page 364 Setting Method)
2. Set the table data in the high speed I/O parameter of GX Works3. (Page 487 How to Use the Positioning Table)
3. Program the table operation instruction. (Page 524 Table Operation Instruction)

This section describes procedure 2 above.

### Table setting method

Set the table in the high speed I/O of GX Works3.

#### Window

#### ■CPU module

[Navigation window] ⇒ [Parameter] ⇒ Module model name ⇒ [Module Parameter] ⇒ [High Speed I/O] ⇒ [Output Function] ⇒ [Positioning] ⇒ [Detailed Setting] ⇒ [Positioning Data]<sup>\*1</sup>

Table Data		Use Device	(Axis 1 to Axis 4 Common)							
		Not to Use an Initialization Invalid SM	(Initialization of table data can be invalid by SM)							
NO.	Device	Control Method	Axis to be Interpolated	Positioning Address	Command Speed	Dwell Time	Interrupt Counts	Interrupt Input Signal 2 Device No.	Jump Destination Table No.	M No. for Jump Condition
1	D100	4: Variable Speed Operation	Axis 2 Specification	0 pulse	10000 pps	0 ms	1 Times X0		1	0
2	D106	1: 1 Speed Positioning (Relative Address Specification)	Axis 2 Specification	100000 pulse	30000 pps	0 ms	1 Times X0		1	0
3	D112	1: 1 Speed Positioning (Relative Address Specification)	Axis 2 Specification	-10000 pulse	2000 pps	0 ms	1 Times X0		1	0
4	D118	1: 1 Speed Positioning (Relative Address Specification)	Axis 2 Specification	20000 pulse	140000 pps	0 ms	1 Times X0		1	0
5	D124	0: No Positioning	Axis 2 Specification	0 pulse	1 pps	0 ms	1 Times X0		1	0
6	D130	0: No Positioning	Axis 2 Specification	0 pulse	1 pps	0 ms	1 Times X0		1	0
7	D136	0: No Positioning	Axis 2 Specification	0 pulse	1 pps	0 ms	1 Times X0		1	0
8	D142	0: No Positioning	Axis 2 Specification	0 pulse	1 pps	0 ms	1 Times X0		1	0
9	D148	2: Interrupt 1 Speed Positioning	Axis 2 Specification	30000 pulse	100000 pps	10 ms	20 Times X0		1	0
10	D154	2: Interrupt 1 Speed Positioning	Axis 2 Specification	2000 pulse	20000 pps	10 ms	10 Times X0		1	0
11	D160	0: No Positioning	Axis 2 Specification	0 pulse	1 pps	0 ms	1 Times X0		1	0
12	D166	0: No Positioning	Axis 2 Specification	0 pulse	1 pps	0 ms	1 Times X0		1	0
13	D172	4: Variable Speed Operation	Axis 2 Specification	0 pulse	10000 pps	0 ms	1 Times X0		1	0
14	D178	4: Variable Speed Operation	Axis 2 Specification	0 pulse	20000 pps	0 ms	1 Times X0		1	0
15	D184	4: Variable Speed Operation	Axis 2 Specification	0 pulse	10000 pps	0 ms	1 Times X0		1	0
16	D190	0: No Positioning	Axis 2 Specification	0 pulse	1 pps	0 ms	1 Times X0		1	0
17	D196	10: Condition Jump	Axis 2 Specification	0 pulse	1 pps	0 ms	1 Times X0		2	100
18	D202	0: No Positioning	Axis 2 Specification	0 pulse	1 pps	0 ms	1 Times X0		1	0

\*1 When FX5SCPU/FX5UCPU is selected: Axis #1 Positioning Data to Axis #4 Positioning Data.  
When FX5UJCPU is selected: Axis #1 Positioning Data to Axis #3 Positioning Data.

## ■High-speed pulse input/output module

Navigation window ⇒ Parameter ⇒ Module Information ⇒ Right-click ⇒ Add New Module

After adding the high-speed pulse input/output module, make settings on the screen displayed from the following operation.

Navigation window ⇒ Parameter ⇒ Module Information ⇒ 1 to 16 (high-speed pulse input/output module) ⇒ Module Parameter ⇒ Output Function ⇒ Positioning ⇒ Detailed Setting ⇒ Axis #5 Positioning Data to Axis #12 Positioning Data

NO.	Device	Control Method	Axis to be Interpolated	Positioning Address	Command Speed	Dwell Time	Interrupt Counts	Interrupt Input Signal 2 Device No.	Jump Destination Table No.	M No. for Jump Condition
1	D1000	4: Variable Speed Operation	Axis 6 Specification	0 pulse	10000 pps	0 ms	1 Times X0		1	0
2	D1005	1: 1 Speed Positioning (Relative Address Specification)	Axis 6 Specification	100000 pulse	30000 pps	0 ms	1 Times X0		1	0
3	D1012	1: 1 Speed Positioning (Relative Address Specification)	Axis 6 Specification	-10000 pulse	2000 pps	0 ms	1 Times X0		1	0
4	D1018	1: 1 Speed Positioning (Relative Address Specification)	Axis 6 Specification	20000 pulse	140000 pps	0 ms	1 Times X0		1	0
5	D1024	0: No Positioning	Axis 6 Specification	0 pulse	1 pps	0 ms	1 Times X0		1	0
6	D1030	0: No Positioning	Axis 6 Specification	0 pulse	1 pps	0 ms	1 Times X0		1	0
7	D1036	0: No Positioning	Axis 6 Specification	0 pulse	1 pps	0 ms	1 Times X0		1	0
8	D1042	0: No Positioning	Axis 6 Specification	0 pulse	1 pps	0 ms	1 Times X0		1	0
9	D1048	3: Interrupt 1 Speed Positioning	Axis 6 Specification	30000 pulse	100000 pps	10 ms	20 Times X0		1	0
10	D1054	3: Interrupt 1 Speed Positioning	Axis 6 Specification	20000 pulse	20000 pps	10 ms	10 Times X0		1	0
11	D1060	0: No Positioning	Axis 6 Specification	0 pulse	1 pps	0 ms	1 Times X0		1	0
12	D1066	0: No Positioning	Axis 6 Specification	0 pulse	1 pps	0 ms	1 Times X0		1	0
13	D1072	4: Variable Speed Operation	Axis 6 Specification	0 pulse	10000 pps	0 ms	1 Times X0		1	0
14	D1078	4: Variable Speed Operation	Axis 6 Specification	0 pulse	20000 pps	0 ms	1 Times X0		1	0
15	D1084	4: Variable Speed Operation	Axis 6 Specification	0 pulse	10000 pps	0 ms	1 Times X0		1	0
16	D1090	0: No Positioning	Axis 6 Specification	0 pulse	1 pps	0 ms	1 Times X0		1	0
17	D1096	10: Condition Jump	Axis 6 Specification	0 pulse	1 pps	0 ms	1 Times X0		2	100
18	D1102	0: No Positioning	Axis 6 Specification	0 pulse	1 pps	0 ms	1 Times X0		1	0

Shown above is the screen at the time of the selection of the data for axis 5 positioning.

## Items setting

### ■Positioning table data use device setting

The table data specified is used as a parameter of the CPU module. Specify whether to set the parameter in user-specified word devices. Available devices are limited to data registers (D) and file registers (R).

It is always necessary to set the parameters to word devices for high-speed pulse input/output module.

The positioning table data is set to use device	Parameter (The positioning table data is not set to use device)*1
<ul style="list-style-type: none"> <li>Up to 100 tables can be used per axis.</li> <li>The command speed and positioning address can be changed while a program is being executed.</li> <li>Six word devices are occupied per table.</li> </ul>	<ul style="list-style-type: none"> <li>No word devices are occupied.</li> <li>Up to 32 tables can be used per axis.</li> <li>The command speed and positioning address cannot be changed while a program is being executed.</li> </ul>

\*1 Only CPU module is supported.

Table Data	Use Device	(Axis 1 to Axis 4 Common)		
	Not to Use an Initialization Invalid SM	(Initialization of table data can be invalid by SM)		
NO.	Device	Control Method	Axis to be Interpolated	Positioning Address
1	D100	4: Variable Speed Operation	Axis 2 Specification	0 pulse
2	D106	1: 1 Speed Positioning (Relative Address Specification)	Axis 2 Specification	100000 pulse

Select "Use Device" to specify a data register or file register in the "Device" field of table No. 1. With the specified device used as the head device, one table occupies six word devices, and 100 tables of word devices (600 word devices) are occupied in total. Devices can be set per axis, but the device range occupied by each axis must not overlap. Unoccupied devices can be used as general-purpose devices even when tables are set to the devices.

Table data is assigned to an operand of the control method of each table. When table data is set to a device, it is stored in the device corresponding to the data of the operand. Assuming that the head device is D100, devices are set as shown in the following table. The same operand numbers are also used when table data is not set to devices.

Table No.	Device	Operand1 (+0, +1)	Operand2 (+2, +3)	Operand3 (+4)	Operand4 (+5)
1	D100	D100, D101	D102, D103	D104	D105
2	D106	D106, D107	D108, D109	D110	D111
3	D112	D112, D113	D114, D115	D116	D117
:					
100	D694	D694, D695	D696, D697	D698	D699

## Table data

Set table parameters that are applied when a table operation instruction is executed.

NO.	Device	Control Method	Axis to be Interpolated	Positioning Address	Command Speed	Dwell Time	Interrupt Counts	Interrupt Input Signal 2 Device No.	Jump Destination Table No.	M No. for Jump Condition
1	D100	4: Variable Speed Operation	Axis 2 Specification	0 pulse	10000 pps	0 ms	1 Times X0		1	0
2	D106	1: 1 Speed Positioning (Relative Address Specification)	Axis 2 Specification	100000 pulse	30000 pps	0 ms	1 Times X0		1	0
3	D112	1: 1 Speed Positioning (Relative Address Specification)	Axis 2 Specification	-10000 pulse	2000 pps	0 ms	1 Times X0		1	0

Set a control method and operands corresponding to the type.

When the positioning table data is set to use device, the operands of this table are set in the user devices. When the operands are set to use devices, the command speed and positioning address can be changed from word devices. Thus, the command speed and positioning address can be changed during positioning operation. The control method is not set in user devices, and thus cannot be changed. For tables in which the positioning type is not set, the setting control method [0: No positioning] is applied.

The following table lists setting items for each table of each axis.

Item	Description	Reference
Control Method	0: No Positioning	Page 490
	1: 1 Speed Positioning (Relative Address Specification)	Page 491
	2: 1 Speed Positioning (Absolute Address Specification)	Page 493
	3: Interrupt 1 Speed Positioning	Page 495
	4: Variable Speed Operation	Page 498
	5: Table Transition Variable Speed Operation* <sup>2</sup>	Page 500
	6: Interrupt Stop (Relative Address Specification)	Page 502
	7: Interrupt Stop (Absolute Address Specification)	Page 505
	10: Condition Jump	Page 507
	20: Interpolation Operation (Relative Address Specification)* <sup>3</sup>	Page 509
	21: Interpolation Operation (Relative Address Specification Target Axis)* <sup>3</sup>	Page 513
	22: Interpolation Operation (Absolute Address Specification)* <sup>3</sup>	Page 514
	23: Interpolation Operation (Absolute Address Specification Target Axis)* <sup>3</sup>	Page 518
Operand 1* <sup>1</sup>	Positioning Address	Page 378
Operand 2* <sup>1</sup>	Command Speed	Page 375
Operand 3* <sup>1</sup>	Dwell Time	Page 393
	Jump Destination Table No.	Page 394
Operand 4* <sup>1</sup>	Interrupt Counts	Page 393
	Interrupt Input Signal 2 Device No.	Page 394
	M No. for Jump Condition	Page 394
	Axis to be Interpolated* <sup>3</sup>	Page 395

\*1 The setting details and whether the setting is available or not differ depending on the control method.

\*2 Only CPU module is supported.

\*3 Only FX5S/FX5U/FX5UC CPU module and high-speed pulse input/output module support interpolation operation.

## ■Positioning table data retaining function

This function retains the setting value of the device where the positioning table data is set.

When the positioning table data is changed from word devices ( [Page 489 Table data](#)), the table data setting value is overwritten with the setting value in GX Works3 after the power of the CPU module is turned OFF and ON, the PLC is stopped and restarted, or system is reset. To retain the table data settings value changed from word devices, use the positioning table data retaining function.

1. "Use Device"\*1 and "Use an Initialization Invalid SM" are selected in the table data.

Table Data	Use Device (Axis 1 to Axis 4 Common)			
	Use an Initialization Invalid SM (Initialization of table data can be invalid by SM)			
NO.	Device	Control Method	Axis to be Interpolated	Positioning Address
1	D100	4: Variable Speed Operation	Axis 2 Specification	0 pulse
2	D106	1: 1 Speed Positioning (Relative Address Specification)	Axis 2 Specification	100000 pulse

2. Turn on Positioning table data initialization disable (SM5916 to 5927). ( [Page 397 Positioning table data initialization disable](#))

\*1 Only CPU module

For versions which support the positioning table data retaining function, refer to [Page 966 Added and Enhanced Functions](#).

### Precautions

Use latch devices for the table data. ( [Page 123 LATCH FUNCTION](#))

## 33.2 Operations of Control Method

The following describes the control method that can be set in a table.

For details of each table operation instruction, refer to [Page 402 POSITIONING INSTRUCTION](#).

### No Positioning

The following describes control method [0: No Positioning].

#### Setting data

The following table shows the operand assignment.

Item	Operand 1	Operand 2	Operand 3	Operand 4
Description	None	None	None	None
Range	—	—	—	—
Details	None	None	None	None

#### Processing details

This table unconditionally turns on the positioning complete flag and ends the table operation instruction. This control method cannot be executed before the other positioning types.

If a table that is not set with a parameter (empty table) is specified, control method [0: No Positioning] is applied.

#### Precautions

- If a table with this positioning type is included between the first table and last table when multiple tables are executed such as continuous operation, tables that follow the table with control method [0: No Positioning] do not operate.
- The complete flag turns on after the operation of the previous table is decelerated to a stop and the dwell time elapses.
- When user devices are used, devices assigned to a table of control method [0: No Positioning] (first device +0 to +5) are not used in table operation. Users can use such devices for any purpose.

## Related devices

Related devices of axis 4 are available only for the FX5S/FX5U/FX5UC CPU module.

### ■CPU module

Axis 1	Axis 2	Axis 3	Axis 4	Name	High speed I/O parameter	R/W	Reference
SM8029 (FX3 compatible device)				Instruction execution complete flag	×	R	Page 400
SM8329 (FX3 compatible device)				Instruction execution abnormal end flag	×	R	

R: Read only, ×: Not supported

### ■High-speed pulse input/output module

First module		Second module		Third module		Fourth module		Name	High speed I/O parameter	R/W	Reference
Axis 5	Axis 6	Axis 7	Axis 8	Axis 9	Axis 10	Axis 11	Axis 12				
SM8029 (FX3 compatible device)								Instruction execution complete flag	×	R	Page 400
SM8329 (FX3 compatible device)								Instruction execution abnormal end flag	×	R	

R: Read only, ×: Not supported

## Operation of the complete flags

The following describes the operation timings of the complete flags. Because dwell time cannot be specified, the flags turn on immediately after the condition is met.

Item	FX3 compatible (Effective only at TBL instruction or DRVTBL instruction execution)		User specification (Effective only at DRVTBL instruction or DRVMUL instruction execution)	
	Instruction execution complete flag (SM8029)	Instruction execution abnormal end flag (SM8329)	Instruction execution complete flag	Instruction execution abnormal end flag
ON condition	From when the table operation is started*1 to when the drive contact is turned off	Does not turn on.	From when the table operation is started*1 to when the ON → OFF condition is met	Does not turn on.
ON → OFF condition	When the drive contact is turned off	From when the table operation is started to when the drive contact is turned off	The flag remains on until either of the following is performed. <ul style="list-style-type: none"> <li>Turning off the flag by the user</li> <li>Restarting the table instruction</li> </ul>	

\*1 The completion flag immediately turns ON after the drive contact turns ON.

## 1 Speed Positioning (Relative Address Specification)

The following describes control method [1: 1 Speed Positioning (Relative Address Specification)].

### Setting data

The following table shows the operand assignment.

Item	Operand 1*1	Operand 2*2	Operand 3*3	Operand 4
Description	Positioning Address	Command Speed	Dwell Time	None
Range	-2147483648 to +2147483647 (User system unit)	1 to 2147483647 (User system unit)	0 to 32767 (ms)	—
Details	Set the relative address within the range of -2147483648 to +2147483647*4 in pulse.	Set the speed within the range of 1 pps to 200 kpps in pulse. For the FX5S CPU module, set a value 1 pps to 100 kpps.	Dwell time is the time until the complete flag turns on after the positioning address is reached.	None

\*1 The positioning address can be changed during positioning operation. (☞ Page 359 Positioning address change during positioning operation) However, only the last table accepts the change in the case of continuous operation.

\*2 Command speed can be changed during positioning operation. (☞ Page 360 Command speed change during positioning operation)

\*3 When the positioning table data is set to use device, the value can be changed during positioning operation. The change is applied when the table operation instruction is restarted.

\*4 Set the number of output pulses per table execution to 2147483647 or lower.

## Processing details

Operation with one table and operation of stepping operation are the same as that of the DRVI/DDRVI instruction. (☞ Page 519 Stepping operation, Page 421 Relative Positioning) However, if dwell time is set, the complete flag turns on after the dwell time elapses. (☞ Page 400 Complete flag)

In addition, this table can be specified for continuous operation. (☞ Page 521 Continuous operation)

## Precautions

The same cautions as for the DRVI/DDRVI instruction apply.

## Related devices

Other than the following, the related devices are the same as those of the DRVI/DDRVI instruction. Related devices of axis 4 are available only for the FX5S/FX5U/FX5UC CPU module.

### ■Special relays

- CPU module

Axis 1	Axis 2	Axis 3	Axis 4	Name	High speed I/O parameter	R/W	Reference
SM5916	SM5917	SM5918	SM5919	Positioning table data initialization disable	×	R/W	Page 397

R/W: Read/write, ×: Not supported

- High-speed pulse input/output module

First module		Second module		Third module		Fourth module		Name	High speed I/O parameter	R/W	Reference
Axis 5	Axis 6	Axis 7	Axis 8	Axis 9	Axis 10	Axis 11	Axis 12				
SM5920	SM5921	SM5922	SM5923	SM5924	SM5925	SM5926	SM5927	Positioning table data initialization disable	×	R/W	Page 397

R/W: Read/write, ×: Not supported

### ■Special registers

- CPU module

Axis 1	Axis 2	Axis 3	Axis 4	Name	High speed I/O parameter	R/W	Reference
SD5506	SD5546	SD5586	SD5626	Positioning execution table number	×	R	Page 396
SD5511	SD5551	SD5591	SD5631	Positioning error (error occurrence table No.)	×	R/W	Page 397

R: Read only, R/W: Read/write, ×: Not supported

- High-speed pulse input/output module

First module		Second module		Third module		Fourth module		Name	High speed I/O parameter	R/W	Reference
Axis 5	Axis 6	Axis 7	Axis 8	Axis 9	Axis 10	Axis 11	Axis 12				
SD5666	SD5706	SD5746	SD5786	SD5826	SD5866	SD5906	SD5946	Positioning execution table number	×	R	Page 396
SD5671	SD5711	SD5751	SD5791	SD5831	SD5871	SD5911	SD5951	Positioning error (error occurrence table No.)	×	R/W	Page 397

R: Read only, R/W: Read/write, ×: Not supported

## Operation of the complete flags

The following describes the operation timings of the complete flags. Because dwell time cannot be specified, the flags turn on immediately after the condition is met.

Item	FX3 compatible (Effective only at TBL instruction or DRVTBL instruction execution)		User specification (Effective only at DRVTBL instruction or DRVMUL instruction execution)	
	Instruction execution complete flag (SM8029)	Instruction execution abnormal end flag (SM8329)	Instruction execution complete flag	Instruction execution abnormal end flag
ON condition	From when pulse output of the specified positioning address is completed to when the drive contact is turned off	From when the following operation or function is completed to when the drive contact is turned off <ul style="list-style-type: none"> <li>• The axis is already used.*1</li> <li>• Pulse output stop command</li> <li>• Pulse decelerate and stop command*2</li> <li>• Limit of the moving direction</li> <li>• All module reset when a stop error occurs*3</li> <li>• All outputs disabled (SM8034)</li> <li>• Positioning address error</li> <li>• Deceleration stop after the command speed is changed to 0</li> <li>• Table shift cannot be completed in time</li> </ul>	From when pulse output of the specified positioning address is completed to when the ON → OFF condition is met	From when the following operation or function is completed to when the ON → OFF condition is met <ul style="list-style-type: none"> <li>• The axis is already used.</li> <li>• The drive contact is turned off during positioning operation</li> <li>• Pulse output stop command</li> <li>• Pulse decelerate and stop command*2</li> <li>• Limit of the moving direction</li> <li>• All module reset when a stop error occurs*3</li> <li>• All outputs disabled (SM8034)</li> <li>• Online change</li> <li>• Positioning address error</li> <li>• Deceleration stop after the command speed is changed to 0</li> <li>• Table shift cannot be completed in time</li> </ul>
ON → OFF condition	When the drive contact is turned off		The flag remains on until either of the following is performed. <ul style="list-style-type: none"> <li>• Turning off the flag by the user</li> <li>• Restarting the table instruction</li> <li>• Shift to the next table</li> </ul>	

\*1 The flag turns on only for one scan when the drive contact of the instruction turns from OFF to ON.

\*2 When remaining distance operation enabled is turn on, abnormal end flag is not turn on. (☞ Page 385 Remaining distance operation enabled)

\*3 Only high-speed pulse input/output module is supported.

## 1 Speed Positioning (Absolute Address Specification)

The following describes control method [2: 1 Speed Positioning (Absolute Address Specification)].

### Setting data

The following table shows the operand assignment.

Item	Operand 1*1	Operand 2*2	Operand 3*3	Operand 4
Description	Positioning Address	Command Speed	Dwell Time	None
Range	-2147483648 to +2147483647 (User system unit)	1 to 2147483647 (User system unit)	0 to 32767 (ms)	—
Details	Set the absolute address within the range of -2147483648 to +2147483647*4 in pulse.	Set the speed within the range of 1 pps to 200 kpps in pulse. For the FX5S CPU module, set a value 1 pps to 100 kpps.	Dwell time is the time until the complete flag turns on after the positioning address is reached.	None



\*1 The positioning address can be changed during positioning operation. (☞ Page 359 Positioning address change during positioning operation) However, only the last table accepts the change in the case of continuous operation.

\*2 Command speed can be changed during positioning operation. (☞ Page 360 Command speed change during positioning operation)

\*3 When the positioning table data is set to use device, the value can be changed during positioning operation. The change is applied when the table operation instruction is restarted.

\*4 Set the number of output pulses per table execution to 2147483647 or lower.

## Processing details

Operation with one table and operation of stepping operation are the same as that of the DRVA/DDRVA instruction. (  Page 519 Stepping operation, Page 431 Absolute Positioning) However, if dwell time is set, the complete flag turns on after the dwell time elapses. (  Page 400 Complete flag)

In addition, this table can be specified for continuous operation. (  Page 521 Continuous operation)

## Precautions

The same cautions as for the DRVA/DDRVA instruction apply.

## Related devices

Other than the following, the related devices are the same as those of the DRVA/DDRVA instruction. Related devices of axis 4 are available only for the FX5S/FX5U/FX5UC CPU module.

### ■Special relays

- CPU module

Axis 1	Axis 2	Axis 3	Axis 4	Name	High speed I/O parameter	R/W	Reference
SM5916	SM5917	SM5918	SM5919	Positioning table data initialization disable	×	R/W	Page 397

R/W: Read/write, ×: Not supported

- High-speed pulse input/output module

First module		Second module		Third module		Fourth module		Name	High speed I/O parameter	R/W	Reference
Axis 5	Axis 6	Axis 7	Axis 8	Axis 9	Axis 10	Axis 11	Axis 12				
SM5920	SM5921	SM5922	SM5923	SM5924	SM5925	SM5926	SM5927	Positioning table data initialization disable	×	R/W	Page 397

R/W: Read/write, ×: Not supported

### ■Special registers

- CPU module

Axis 1	Axis 2	Axis 3	Axis 4	Name	High speed I/O parameter	R/W	Reference
SD5506	SD5546	SD5586	SD5626	Positioning execution table number	×	R	Page 396
SD5511	SD5551	SD5591	SD5631	Positioning error (error occurrence table No.)	×	R/W	Page 397

R: Read only, R/W: Read/write, ×: Not supported

- High-speed pulse input/output module

First module		Second module		Third module		Fourth module		Name	High speed I/O parameter	R/W	Reference
Axis 5	Axis 6	Axis 7	Axis 8	Axis 9	Axis 10	Axis 11	Axis 12				
SD5666	SD5706	SD5746	SD5786	SD5826	SD5866	SD5906	SD5946	Positioning execution table number	×	R	Page 396
SD5671	SD5711	SD5751	SD5791	SD5831	SD5871	SD5911	SD5951	Positioning error (error occurrence table No.)	×	R/W	Page 397

R: Read only, R/W: Read/write, ×: Not supported



## Operation of the complete flags

The following describes the operation timings of the complete flags. Because dwell time cannot be specified, the flags turn on immediately after the condition is met.

Item	FX3 compatible (Effective only at TBL instruction or DRVTBL instruction execution)		User specification (Effective only at DRVTBL instruction or DRVMUL instruction execution)	
	Instruction execution complete flag (SM8029)	Instruction execution abnormal end flag (SM8329)	Instruction execution complete flag	Instruction execution abnormal end flag
ON condition	From when pulse output of the specified positioning address is completed to when the drive contact is turned off	From when the following operation or function is completed to when the drive contact is turned off <ul style="list-style-type: none"> <li>• The axis is already used.*1</li> <li>• Pulse output stop command</li> <li>• Pulse decelerate and stop command*2</li> <li>• Limit of the moving direction</li> <li>• All module reset when a stop error occurs*3</li> <li>• All outputs disabled (SM8034)</li> <li>• Positioning address error</li> <li>• Deceleration stop after the command speed is changed to 0</li> <li>• Table shift cannot be completed in time</li> </ul>	From when pulse output of the specified positioning address is completed to when the ON → OFF condition is met	From when the following operation or function is completed to when the ON → OFF condition is met <ul style="list-style-type: none"> <li>• The axis is already used.</li> <li>• The drive contact is turned off during positioning operation</li> <li>• Pulse output stop command</li> <li>• Pulse decelerate and stop command*2</li> <li>• Limit of the moving direction</li> <li>• All module reset when a stop error occurs*3</li> <li>• All outputs disabled (SM8034)</li> <li>• Online change</li> <li>• Positioning address error</li> <li>• Deceleration stop after the command speed is changed to 0</li> <li>• Table shift cannot be completed in time</li> </ul>
ON → OFF condition	When the drive contact is turned off		The flag remains on until either of the following is performed. <ul style="list-style-type: none"> <li>• Turning off the flag by the user</li> <li>• Restarting the table instruction</li> <li>• Shift to the next table</li> </ul>	

\*1 The flag turns on only for one scan when the drive contact of the instruction turns from OFF to ON.

\*2 When remaining distance operation enabled is turn on, abnormal end flag is not turn on. ( Page 385 Remaining distance operation enabled)

\*3 Only high-speed pulse input/output module is supported.

## Interrupt 1 Speed Positioning

The following describes the control method [3: Interrupt 1 Speed Positioning].

### Setting data

The following table shows the operand assignment.

Item	Operand 1*1	Operand 2*2	Operand 3*3	Operand 4*3
Description	Positioning Address	Command speed	Dwell Time	Interrupt Counts
Range	-2147483648 to +2147483647 (User system unit)	1 to 2147483647 (User system unit)	0 to 32767 (ms)	1 to 32767
Details	Set the transfer distance after interrupt within the range of -2147483648 to +2147483647*4 in pulse.	Set the speed within the range of 1 pps to 200 kpps in pulse. For the FX5S CPU module, set a value 1 pps to 100 kpps.	Dwell time is the time until the complete flag turns on after the positioning address is reached.	This is the count of inputs that are necessary for interrupt. The setting is enabled only in the high-speed mode.

\*1 The positioning address can be changed during positioning operation. ( Page 359 Positioning address change during positioning operation) However, only the last table accepts the change in the case of continuous operation.

\*2 Command speed can be changed during positioning operation. ( Page 360 Command speed change during positioning operation)

\*3 When the positioning table data is set to use device, the value can be changed during positioning operation. The change is applied when the table operation instruction is restarted.

\*4 Set the number of output pulses per table execution (the total number of pulses before and after the interrupt) to 2147483647 or lower.

## Processing details

Operation with one table and operation of stepping operation are the same as that of the DVIT/DDVIT instruction. (☞ Page 519 Stepping operation, Page 440 Interrupt 1-Speed Positioning) If dwell time is set, the complete flag turns on after the dwell time elapses. (☞ Page 400 Complete flag)

In addition, this table can be specified for continuous operation only for the CPU module. (☞ Page 521 Continuous operation)

## Precautions

Other than the following, the same as cautions for the DVIT/DDVIT instruction apply.

- Combinations other than the following cannot be used during continuous operation.

Item	The first table	The second table
Control method	3: Interrupt 1 Speed Positioning	—
	5: Table Transition Variable Speed Operation	3: Interrupt 1 Speed Positioning

Control method [3: Interrupt 1 Speed Positioning] must be specified to the first or second table. If control method [3: Interrupt 1 Speed Positioning] is specified to the second table, only control method [5: Table Transition Variable Speed Operation] can be specified to the first table.

- Continuous operation cannot be used for the high-speed pulse input/output module. If this table is specified for continuous operation for the high-speed pulse input/output module, an error occurs.

## Related devices

Other than the following, the related devices are the same as those of the DVIT/DDVIT instruction. Related devices of axis 4 are available only for the FX5S/FX5U/FX5UC CPU module.

### ■ Special relays

- CPU module

Axis 1	Axis 2	Axis 3	Axis 4	Name	High speed I/O parameter	R/W	Reference
SM5916	SM5917	SM5918	SM5919	Positioning table data initialization disable	×	R/W	Page 397

R/W: Read/write, ×: Not supported

- High-speed pulse input/output module

First module		Second module		Third module		Fourth module		Name	High speed I/O parameter	R/W	Reference
Axis 5	Axis 6	Axis 7	Axis 8	Axis 9	Axis 10	Axis 11	Axis 12				
SM5920	SM5921	SM5922	SM5923	SM5924	SM5925	SM5926	SM5927	Positioning table data initialization disable	×	R/W	Page 397

R/W: Read/write, ×: Not supported

## ■ Special registers

- CPU module

Axis 1	Axis 2	Axis 3	Axis 4	Name	High speed I/O parameter	R/W	Reference
SD5506	SD5546	SD5586	SD5626	Positioning execution table number	×	R	Page 396
SD5511	SD5551	SD5591	SD5631	Positioning error (error occurrence table No.)	×	R/W	Page 397

R: Read only, R/W: Read/write, ×: Not supported

- High-speed pulse input/output module

First module		Second module		Third module		Fourth module		Name	High speed I/O parameter	R/W	Reference
Axis 5	Axis 6	Axis 7	Axis 8	Axis 9	Axis 10	Axis 11	Axis 12				
SD5666	SD5706	SD5746	SD5786	SD5826	SD5866	SD5906	SD5946	Positioning execution table number	×	R	Page 396
SD5671	SD5711	SD5751	SD5791	SD5831	SD5871	SD5911	SD5951	Positioning error (error occurrence table No.)	×	R/W	Page 397

R: Read only, R/W: Read/write, ×: Not supported

## Operation of the complete flags

The following describes the operation timings of the complete flags. Because dwell time cannot be specified, the flags turn on immediately after the condition is met.

Item	FX3 compatible (Effective only at TBL instruction or DRVTBL instruction execution)		User specification (Effective only at DRVTBL instruction or DRVMUL instruction execution)	
	Instruction execution complete flag (SM8029)	Instruction execution abnormal end flag (SM8329)	Instruction execution complete flag	Instruction execution abnormal end flag
ON condition	From when pulse output of the specified positioning address is completed to when the drive contact is turned off	From when the following operation or function is completed to when the drive contact is turned off <ul style="list-style-type: none"> <li>• The axis is already used.*1</li> <li>• Pulse output stop command</li> <li>• Pulse decelerate and stop command</li> <li>• Limit of the moving direction</li> <li>• All module reset when a stop error occurs*2</li> <li>• All outputs disabled (SM8034)</li> <li>• Positioning address error</li> <li>• Deceleration stop after the command speed is changed to 0</li> </ul>	From when pulse output of the specified positioning address is completed to when the ON → OFF condition is met	From when the following operation or function is completed to when the ON → OFF condition is met <ul style="list-style-type: none"> <li>• The axis is already used.</li> <li>• The drive contact is turned off during positioning operation</li> <li>• Pulse output stop command</li> <li>• Pulse decelerate and stop command</li> <li>• Limit of the moving direction</li> <li>• All module reset when a stop error occurs*2</li> <li>• All outputs disabled (SM8034)</li> <li>• Online change</li> <li>• Positioning address error</li> <li>• Deceleration stop after the command speed is changed to 0</li> </ul>
ON → OFF condition	When the drive contact is turned off		The flag remains on until either of the following is performed. <ul style="list-style-type: none"> <li>• Turning off the flag by the user</li> <li>• Restarting the table instruction</li> <li>• Shift to the next table</li> </ul>	

\*1 The flag turns on only for one scan when the drive contact of the instruction turns from OFF to ON.

\*2 Only high-speed pulse input/output module is supported.

# Variable Speed Operation

The following describes control method [4: Variable Speed Operation].

## Setting data



The following table shows the operand assignment.

Item	Operand 1	Operand 2 <sup>*1</sup>	Operand 3 <sup>*2</sup>	Operand 4
Description	None	Command Speed	Dwell Time	None
Range	—	-2147483648 to +2147483647 (User system unit)	0 to 32767 (ms)	—
Details	None	Set the speed within the range of -200 kpps to +200 kpps in pulse. For the FX5S CPU module, set a value -100 kpps to +100 kpps.	Dwell time is the time until the complete flag turns on.	None

\*1 Command speed can be changed during positioning operation. (  Page 360 Command speed change during positioning operation)

\*2 When the positioning table data is set to use device, the value can be changed during positioning operation. The change is applied when the table operation instruction is restarted.

## Processing details

Operation with one table and operation of stepping operation are the same as that of the PLSV/DPLSV instruction. (  Page 519 Stepping operation, Page 450 Variable Speed Operation) When this table is used, deceleration stop is performed by turning off the drive contact of the table operation instruction. If dwell time is set, the complete flag turns on after the dwell time elapses. (  Page 400 Complete flag)

## Precautions

Other than the following, the operation is the same as that of the PLSV/DPLSV instruction.

- When this table is used for stepping operation, the next table can be activated after stop using the pulse decelerate and stop command. (  Page 383 Pulse decelerate and stop command)
- This table cannot be specified for continuous operation.
- If the command speed is changed to 0 during positioning operation, pulses are decelerated to a stop but the table operation does not end. Thus, dwell time is not measured and tables are not switched. When the drive contact of the table operation instruction is on, changing the command speed restarts pulse output.

## Related devices

Other than the following, the related devices are the same as those of the PLSV/DPLSV instruction. Related devices of axis 4 are available only for the FX5S/FX5U/FX5UC CPU module.

### ■Special relays

- CPU module

Axis 1	Axis 2	Axis 3	Axis 4	Name	High speed I/O parameter	R/W	Reference
SM5916	SM5917	SM5918	SM5919	Positioning table data initialization disable	×	R/W	Page 397

R/W: Read/write, ×: Not supported

- High-speed pulse input/output module

First module		Second module		Third module		Fourth module		Name	High speed I/O parameter	R/W	Reference
Axis 5	Axis 6	Axis 7	Axis 8	Axis 9	Axis 10	Axis 11	Axis 12				
SM5920	SM5921	SM5922	SM5923	SM5924	SM5925	SM5926	SM5927	Positioning table data initialization disable	×	R/W	Page 397

R/W: Read/write, ×: Not supported

## ■ Special registers

- CPU module

Axis 1	Axis 2	Axis 3	Axis 4	Name	High speed I/O parameter	R/W	Reference
SD5506	SD5546	SD5586	SD5626	Positioning execution table number	×	R	Page 396
SD5511	SD5551	SD5591	SD5631	Positioning error (error occurrence table No.)	×	R/W	Page 397

R: Read only, R/W: Read/write, ×: Not supported

- High-speed pulse input/output module

First module		Second module		Third module		Fourth module		Name	High speed I/O parameter	R/W	Reference
Axis 5	Axis 6	Axis 7	Axis 8	Axis 9	Axis 10	Axis 11	Axis 12				
SD5666	SD5706	SD5746	SD5786	SD5826	SD5866	SD5906	SD5946	Positioning execution table number	×	R	Page 396
SD5671	SD5711	SD5751	SD5791	SD5831	SD5871	SD5911	SD5951	Positioning error (error occurrence table No.)	×	R/W	Page 397

R: Read only, R/W: Read/write, ×: Not supported

## Operation of the complete flags

The following describes the operation timings of the complete flags. Because dwell time cannot be specified, the flags turn on immediately after the condition is met.

Item	FX3 compatible (Effective only at TBL instruction or DRVTBL instruction execution)		User specification (Effective only at DRVTBL instruction or DRVMUL instruction execution)	
	Instruction execution complete flag (SM8029)	Instruction execution abnormal end flag (SM8329)	Instruction execution complete flag	Instruction execution abnormal end flag
ON condition	Deceleration stop with the pulse decelerate and stop command	From when the following operation or function is completed to when the drive contact is turned off <ul style="list-style-type: none"> <li>• The axis is already used.*1</li> <li>• Pulse output stop command</li> <li>• Limit of the moving direction</li> <li>• All module reset when a stop error occurs*2</li> <li>• All outputs disabled (SM8034)</li> <li>• A table that cannot be combined is specified.</li> </ul>	Deceleration stop by drive contact off or pulse decelerate and stop command	From when the following operation or function is completed to when the ON → OFF condition is met <ul style="list-style-type: none"> <li>• The axis is already used.</li> <li>• Pulse output stop command</li> <li>• Limit of the moving direction</li> <li>• All module reset when a stop error occurs*2</li> <li>• All outputs disabled (SM8034)</li> <li>• Online change</li> <li>• A table that cannot be combined is specified.</li> </ul>
ON → OFF condition	When the drive contact is turned off		The flag remains on until either of the following is performed. <ul style="list-style-type: none"> <li>• Turning off the flag by the user</li> <li>• Restarting the table instruction</li> <li>• Shift to the next table</li> </ul>	

\*1 The flag turns on only for one scan when the drive contact of the instruction turns from OFF to ON.

\*2 Only high-speed pulse input/output module is supported.

# Table Transition Variable Speed Operation

The following describes control method [5: Table Transition Variable Speed Operation]. Only CPU module is supported.

## Setting data

The following table shows the operand assignment.

Item	Operand 1	Operand 2 <sup>*1</sup>	Operand 3 <sup>*2</sup>	Operand 4 <sup>*2</sup>
Description	None	Command Speed	Dwell Time	Interrupt Input Signal 2 Device No.
Range	—	-2147483648 to +2147483647 (User system unit)	0 to 32767 (ms)	<ul style="list-style-type: none"> <li>■FX5S/FX5U/FX5UC CPU module X0 to X17</li> <li>■FX5UJ CPU module FX5UJ-24MT/□                             <ul style="list-style-type: none"> <li>• X0 to X15</li> </ul> </li> <li>FX5UJ-40MT/□, FX5UJ-60MT/□                             <ul style="list-style-type: none"> <li>• X0 to X17</li> </ul> </li> </ul>
Details	None	Set the speed within the range of -200 kpps to +200 kpps in pulse. For the FX5S CPU module, set a value -100 kpps to +100 kpps.	Dwell time is the time until the complete flag turns on.	Specify the input (X) number.

- \*1 Command speed can be changed during positioning operation. (☞ Page 360 Command speed change during positioning operation)
- \*2 When the positioning table data is set to use device, the value can be changed during positioning operation. The change is applied when the table operation instruction is restarted.

## Processing details

When the interrupt input signal 2 is detected, the table in execution is switched to the next table as interrupt processing. Then, the table following this table is operated. Until the interrupt input signal 2 is turned on, operation equivalent to the PLSV/DPLSV instruction or control method [4: Variable Speed Operation] is performed. (☞ Page 450 Variable Speed Operation, Page 498 Variable Speed Operation)

If dwell time is set, the complete flag turns on after the dwell time elapses. (☞ Page 400 Complete flag)

In addition, this table can be specified for continuous operation. (☞ Page 521 Continuous operation)

The following figure shows an example of an operation equivalent to interrupt 2-speed positioning combining control method [5: Table Transition Variable Speed Operation] and control method [3: Interrupt 1 Speed Positioning].

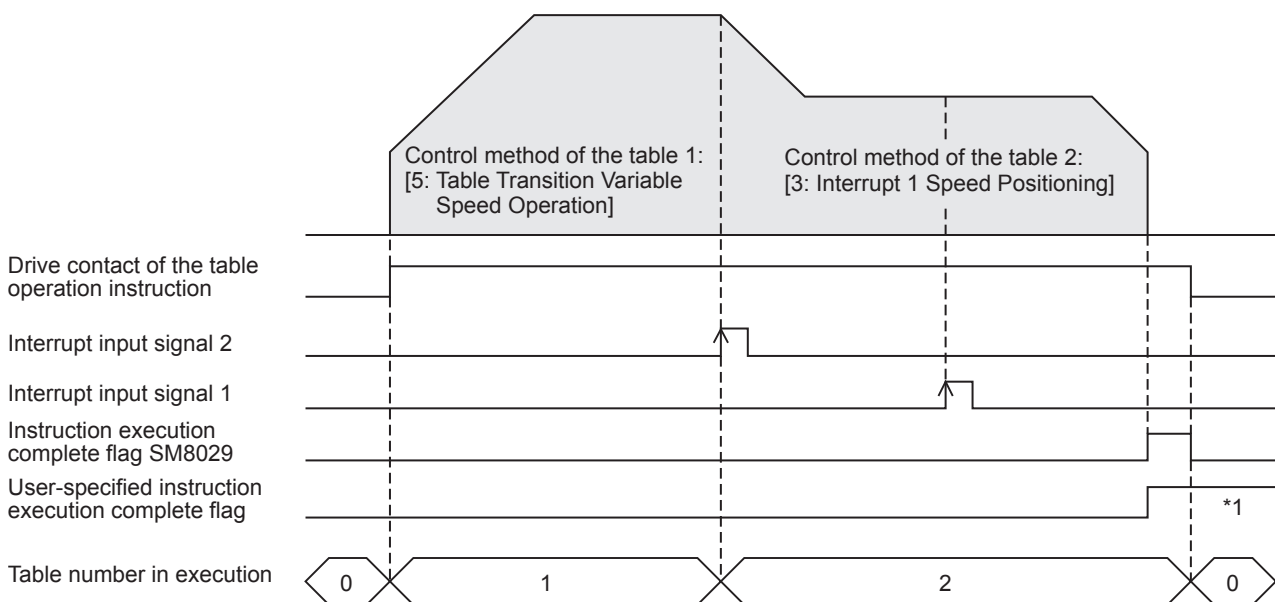

- \*1 Remains on until it is turned off using program or engineering tool, restarts the table operation instruction or until the next table is activated during the continuous operation.

## Precautions

Other than the following, the operation is the same as that of the PLSV/DPLSV instruction.

- If control method [0: No Positioning] is set to the next table, deceleration stop is performed to end the table operation by turning on the interrupt input signal 2. If control method [0: No Positioning] is set to the last table, the same operation is performed.
- If the next table is for variable speed operation or interpolation operation, deceleration stop is performed to end the table operation causing an error.
- When this table is used for stepping operation, the next table can be activated after a stop using the interrupt input signal 2 or pulse decelerate and stop command. If the pulse decelerate and stop command remains ON after stop, the table shift command is disabled.
- Table control methods that can be used in combination during continuous operation are [5: Table Transition Variable Speed Operation] and [3: Interrupt 1 Speed Positioning]. (  Page 495 Interrupt 1 Speed Positioning) An error occurs if Interrupt 1 Speed Positioning is executed after Table Transition Variable Speed Operation two or more times.
- If the command speed is changed to 0 during positioning operation, pulses are decelerated to a stop but the table operation does not end. Thus, dwell time is not measured and tables are not switched. When the drive contact of the table operation instruction is on, or changing to any value other than 0, the command speed restarts pulse output.

## Related devices

Other than the following, the related devices are the same as those of the PLSV/DPLSV instruction. Related devices of axis 4 are available only for the FX5S/FX5U/FX5UC CPU module.

### ■Special relays

Axis 1	Axis 2	Axis 3	Axis 4	Name	High speed I/O parameter	R/W	Reference
SM5916	SM5917	SM5918	SM5919	Positioning table data initialization disable	×	R/W	Page 397

R/W: Read/write, ×: Not supported

### ■Special registers

Axis 1	Axis 2	Axis 3	Axis 4	Name	High speed I/O parameter	R/W	Reference
SD5506	SD5546	SD5586	SD5626	Positioning execution table number	×	R	Page 396
SD5511	SD5551	SD5591	SD5631	Positioning error (error occurrence table No.)	×	R/W	Page 397

R: Read only, R/W: Read/write, ×: Not supported

## Operation of the complete flags

The following describes the operation timings of the complete flags. Because dwell time cannot be specified, the flags turn on immediately after the condition is met.

Item	FX3 compatible (Effective only at TBL instruction or DRVTBL instruction execution)		User specification (Effective only at DRVTBL instruction or DRVMUL instruction execution)	
	Instruction execution complete flag (SM8029)	Instruction execution abnormal end flag (SM8329)	Instruction execution complete flag	Instruction execution abnormal end flag
ON condition	Deceleration stop by pulse decelerate and stop command	From when the following operation or function is completed to when the drive contact is turned off <ul style="list-style-type: none"> <li>• The axis is already used.*1</li> <li>• Shift to the next table is impossible</li> <li>• Pulse output stop command</li> <li>• Limit of the moving direction</li> <li>• All outputs disabled (SM8034)</li> </ul>	Deceleration stop by drive contact off or pulse decelerate and stop command	From when the following operation or function is completed to when the ON → OFF condition is met <ul style="list-style-type: none"> <li>• The axis is already used.</li> <li>• Shift to the next table is impossible</li> <li>• Pulse output stop command</li> <li>• Limit of the moving direction</li> <li>• All outputs disabled (SM8034)</li> <li>• Online change</li> </ul>
ON → OFF condition	When the drive contact is turned off		The flag remains on until either of the following is performed. <ul style="list-style-type: none"> <li>• Turning off the flag by the user</li> <li>• Restarting the table instruction</li> <li>• Shift to the next table</li> </ul>	

\*1 The flag turns on only for one scan when the drive contact of the instruction turns from OFF to ON.

## Interrupt Stop (Relative Address Specification)

The following describes control method [6: Interrupt Stop (Relative Address Specification)].

### Setting data

The following table shows the operand assignment.

Item	Operand 1*1	Operand 2*2	Operand 3*3	Operand 4*3
Description	Positioning Address	Command Speed	Dwell Time	Interrupt Counts
Range	-2147483648 to +2147483647 (User system unit)	1 to 2147483647 (User system unit)	0 to 32767 (ms)	1 to 32767
Details	Set the relative address within the range of -2147483648 to +2147483647*4 in pulse.	Set the speed within the range of 1 pps to 200 kpps in pulse. For the FX5S CPU module, set a value 1 pps to 100 kpps.	Dwell time is the time until the complete flag turns on after the positioning address is reached (interrupt stop).	This is the count of inputs that are necessary for interrupt. The setting is enabled only in the high-speed mode.

\*1 The positioning address can be changed during positioning operation. (☞ Page 359 Positioning address change during positioning operation) However, only the last table accepts the change in the case of continuous operation.

\*2 Command speed can be changed during positioning operation. (☞ Page 360 Command speed change during positioning operation)

\*3 When the positioning table data is set to use device, the value can be changed during positioning operation. The change is applied when the table operation instruction is restarted.

\*4 Set the number of output pulses per table execution to 2147483647 or lower.



## Processing details

Deceleration stop is performed from the point where the interrupt input signal 1 is detected during positioning operation. (☞ Page 381 Interrupt Input Signal 1) When the interrupt input signal 1 is not detected, the operation becomes the same as that of the DRVI/DDRVI instruction or control method [1: 1 Speed Positioning (Relative Address Specification)]. (☞ Page 421 Relative Positioning, Page 491 1 Speed Positioning (Relative Address Specification))

If dwell time is set, the complete flag turns on after the dwell time elapses. (☞ Page 400 Complete flag)

In addition, this table can be specified for continuous operation. (☞ Page 521 Continuous operation)

The following example shows an interrupt stop with dwell time 0 ms.

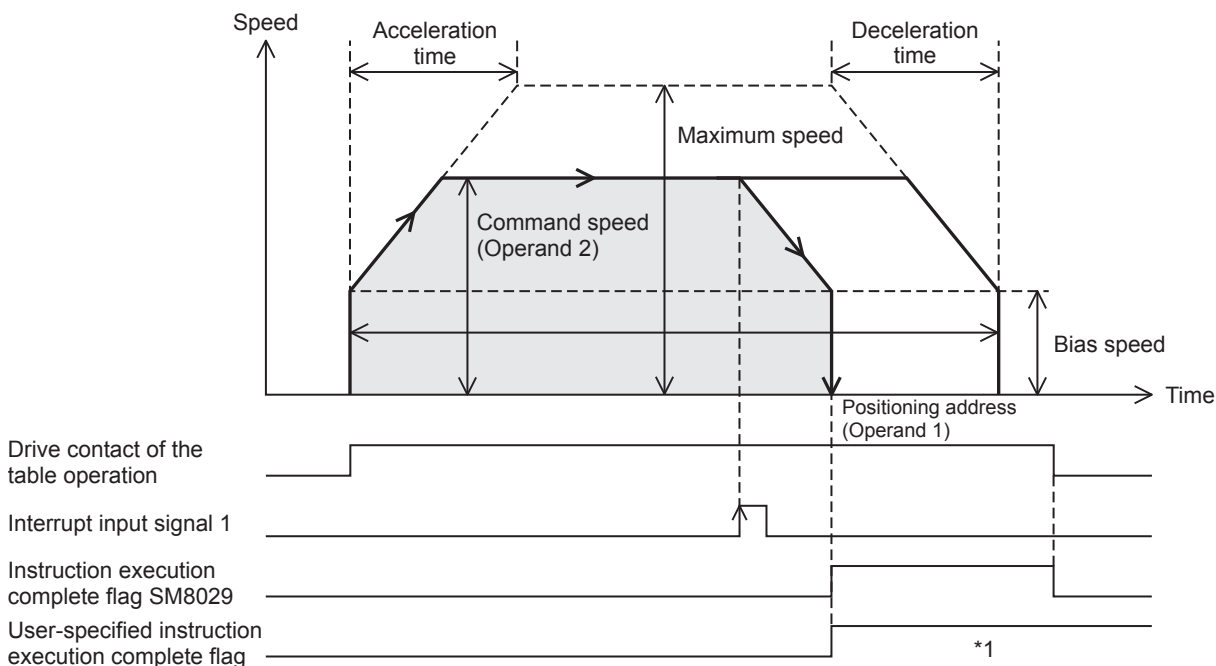

\*1 Remains on until it is turned off using program or engineering tool, restarts the table operation instruction or until the next table is activated during the continuous operation.

## Precautions

Other than the following, the same cautions as for the DRVI/DDRVI instruction apply.

- Specify the table as the last table when performing continuous operation. An error occurs if a table is operated after this table during continuous operation.
- During positioning operation, the positioning address (operand 1) and the command speed (operand 2) can be changed before the interrupt input signal 1 is detected. If they are changed after the interrupt input signal 1 is detected, the change is applied when the table operation instruction is next driven again.

## Related devices

Other than the following, the related devices are the same as those of the DRVI/DDRVI instruction. Related devices of axis 4 are available only for the FX5S/FX5U/FX5UC CPU module.

### Special relays

- CPU module

Axis 1	Axis 2	Axis 3	Axis 4	Name	High speed I/O parameter	R/W	Reference
SM5916	SM5917	SM5918	SM5919	Positioning table data initialization disable	×	R/W	Page 397

R/W: Read/write, ×: Not supported

- High-speed pulse input/output module

First module		Second module		Third module		Fourth module		Name	High speed I/O parameter	R/W	Reference
Axis 5	Axis 6	Axis 7	Axis 8	Axis 9	Axis 10	Axis 11	Axis 12				
SM5920	SM5921	SM5922	SM5923	SM5924	SM5925	SM5926	SM5927	Positioning table data initialization disable	×	R/W	Page 397

R/W: Read/write, ×: Not supported

## Special registers

- CPU module

Axis 1	Axis 2	Axis 3	Axis 4	Name	High speed I/O parameter	R/W	Reference
SD5506	SD5546	SD5586	SD5626	Positioning execution table number	×	R	Page 396
SD5511	SD5551	SD5591	SD5631	Positioning error (error occurrence table No.)	×	R/W	Page 397

R: Read only, R/W: Read/write, ×: Not supported

- High-speed pulse input/output module

First module		Second module		Third module		Fourth module		Name	High speed I/O parameter	R/W	Reference
Axis 5	Axis 6	Axis 7	Axis 8	Axis 9	Axis 10	Axis 11	Axis 12				
SD5666	SD5706	SD5746	SD5786	SD5826	SD5866	SD5906	SD5946	Positioning execution table number	×	R	Page 396
SD5671	SD5711	SD5751	SD5791	SD5831	SD5871	SD5911	SD5951	Positioning error (error occurrence table No.)	×	R/W	Page 397

R: Read only, R/W: Read/write, ×: Not supported

## Operation of the complete flags

The following describes the operation timings of the complete flags. Because dwell time cannot be specified, the flags turn on immediately after the condition is met.

Item	FX3 compatible (Effective only at TBL instruction or DRVTBL instruction execution)		User specification (Effective only at DRVTL instruction or DRVMUL instruction execution)	
	Instruction execution complete flag (SM8029)	Instruction execution abnormal end flag (SM8329)	Instruction execution complete flag	Instruction execution abnormal end flag
ON condition	From when pulse output of the specified positioning address is completed or when deceleration stop is started by an interrupt input to when the drive contact is turned off	From when the following operation or function is completed to when the drive contact is turned off <ul style="list-style-type: none"> <li>• The axis is already used.*1</li> <li>• Pulse output stop command</li> <li>• Pulse decelerate and stop command*2</li> <li>• Limit of the moving direction</li> <li>• All module reset when a stop error occurs*3</li> <li>• All outputs disabled (SM8034)</li> <li>• Positioning address error</li> <li>• Deceleration stop after the command speed is changed to 0</li> <li>• Table shift cannot be completed in time</li> </ul>	From when pulse output of the specified positioning address is completed or when deceleration stop is started by an interrupt input to when the ON → OFF condition is met	From when the following operation or function is completed to when the ON → OFF condition is met <ul style="list-style-type: none"> <li>• The axis is already used.</li> <li>• The drive contact is turned off during positioning operation</li> <li>• Pulse output stop command</li> <li>• Pulse decelerate and stop command*2</li> <li>• Limit of the moving direction</li> <li>• All module reset when a stop error occurs*3</li> <li>• All outputs disabled (SM8034)</li> <li>• Online change</li> <li>• Positioning address error</li> <li>• Deceleration stop after the command speed is changed to 0</li> <li>• Table shift cannot be completed in time</li> </ul>
ON → OFF condition	When the drive contact is turned off		The flag remains on until either of the following is performed. <ul style="list-style-type: none"> <li>• Turning off the flag by the user</li> <li>• Restarting the table instruction</li> <li>• Shift to the next table</li> </ul>	

\*1 The flag turns on only for one scan when the drive contact of the instruction turns from OFF to ON.

\*2 When remaining distance operation enabled is turn on, abnormal end flag is not turn on. (Page 385 Remaining distance operation enabled)

\*3 Only high-speed pulse input/output module is supported.

## Interrupt Stop (Absolute Address Specification)

The following describes control method [7: Interrupt Stop (Absolute Address Specification)]

### Setting data

The following table shows the operand assignment.

Item	Operand 1 <sup>*1</sup>	Operand 2 <sup>*2</sup>	Operand 3 <sup>*3</sup>	Operand 4 <sup>*3</sup>
Description	Positioning Address	Command Speed	Dwell Time	Interrupt Counts
Range	-2147483648 to +2147483647 (User system unit)	1 to 2147483647 (User system unit)	0 to 32767 (ms)	1 to 32767
Details	Set the absolute address within the range of -2147483648 to +2147483647 <sup>*4</sup> in pulse.	Set the speed within the range of 1 pps to 200 kpps in pulse. For the FX5S CPU module, set a value 1 pps to 100 kpps.	Dwell time is the time until the complete flag turns on after the positioning address is reached (interrupt stop).	This is the count of inputs that are necessary for interrupt. The setting is enabled only in the high-speed mode.

- \*1 The positioning address can be changed during positioning operation. (☞ Page 359 Positioning address change during positioning operation) However, only the last table accepts the change in the case of continuous operation.
- \*2 Command speed can be changed during positioning operation. (☞ Page 360 Command speed change during positioning operation)
- \*3 When the positioning table data is set to use device, the value can be changed during positioning operation. The change is applied when the table operation instruction is restarted.
- \*4 Set the number of output pulses per table execution to 2147483647 or lower.

### Processing details

Deceleration stop is performed from the point where the interrupt input signal 1 is detected during positioning operation. (☞ Page 381 Interrupt Input Signal 1) When the interrupt input signal 1 is not detected, the operation becomes the same as that of the DRVA/DDRVA instruction or control method [2: 1 Speed Positioning (Absolute Address Specification)]. (☞ Page 431 Absolute Positioning, Page 493 1 Speed Positioning (Absolute Address Specification))

If dwell time is set, the complete flag turns on after the dwell time elapses. (☞ Page 400 Complete flag)

In addition, this table can be specified for continuous operation. (☞ Page 521 Continuous operation)

The following example shows an interrupt stop with dwell time 0 ms.

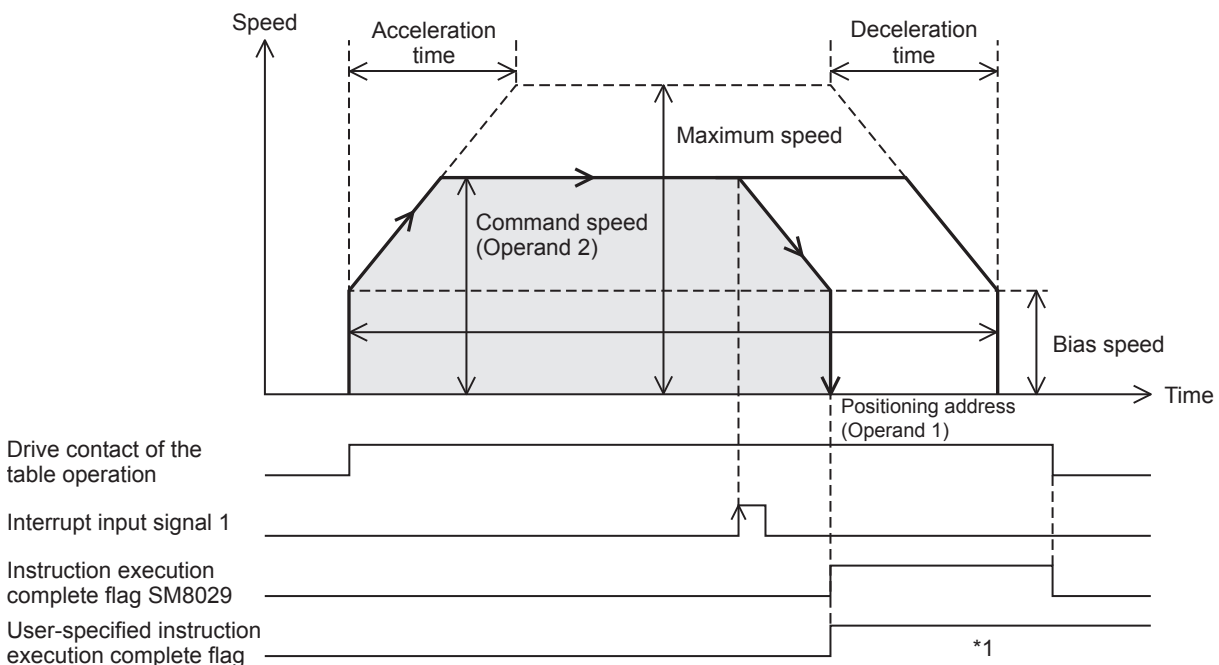

- \*1 Remains on until it is turned off using program or engineering tool, restarts the table operation instruction or until the next table is activated during the continuous operation.

## Precautions

Other than the following, the same cautions as for the DRVA/DDRVA instruction apply.

- Specify the table as the last table when performing continuous operation. An error occurs if a table is operated after this table during continuous operation.
- During positioning operation, the positioning address (operand 1) and the command speed (operand 2) can be changed before the interrupt input signal 1 is detected. If they are changed after the interrupt input signal 1 is detected, the change is applied when the table operation instruction is next driven again.

## Related devices

Other than the following, the related devices are the same as those of the DRVA/DDRVA instruction. Related devices of axis 4 are available only for the FX5S/FX5U/FX5UC CPU module.

### ■Special relays

- CPU module

Axis 1	Axis 2	Axis 3	Axis 4	Name	High speed I/O parameter	R/W	Reference
SM5916	SM5917	SM5918	SM5919	Positioning table data initialization disable	×	R/W	Page 397

R/W: Read/write, ×: Not supported

- High-speed pulse input/output module

First module		Second module		Third module		Fourth module		Name	High speed I/O parameter	R/W	Reference
Axis 5	Axis 6	Axis 7	Axis 8	Axis 9	Axis 10	Axis 11	Axis 12				
SM5920	SM5921	SM5922	SM5923	SM5924	SM5925	SM5926	SM5927	Positioning table data initialization disable	×	R/W	Page 397

R/W: Read/write, ×: Not supported

### ■Special registers

- CPU module

Axis 1	Axis 2	Axis 3	Axis 4	Name	High speed I/O parameter	R/W	Reference
SD5506	SD5546	SD5586	SD5626	Positioning execution table number	×	R	Page 396
SD5511	SD5551	SD5591	SD5631	Positioning error (error occurrence table No.)	×	R/W	Page 397

R: Read only, R/W: Read/write, ×: Not supported

- High-speed pulse input/output module

First module		Second module		Third module		Fourth module		Name	High speed I/O parameter	R/W	Reference
Axis 5	Axis 6	Axis 7	Axis 8	Axis 9	Axis 10	Axis 11	Axis 12				
SD5666	SD5706	SD5746	SD5786	SD5826	SD5866	SD5906	SD5946	Positioning execution table number	×	R	Page 396
SD5671	SD5711	SD5751	SD5791	SD5831	SD5871	SD5911	SD5951	Positioning error (error occurrence table No.)	×	R/W	Page 397

R: Read only, R/W: Read/write, ×: Not supported

## Operation of the complete flags

The following describes the operation timings of the complete flags. Because dwell time cannot be specified, the flags turn on immediately after the condition is met.

Item	FX3 compatible (Effective only at TBL instruction or DRVTBL instruction execution)		User specification (Effective only at DRVTBL instruction or DRVMUL instruction execution)	
	Instruction execution complete flag (SM8029)	Instruction execution abnormal end flag (SM8329)	Instruction execution complete flag	Instruction execution abnormal end flag
ON condition	From when pulse output of the specified positioning address is completed or when deceleration stop is started by an interrupt input to when the drive contact is turned off	From when the following operation or function is completed to when the drive contact is turned off <ul style="list-style-type: none"> <li>• The axis is already used.*1</li> <li>• Pulse output stop command</li> <li>• Pulse decelerate and stop command*2</li> <li>• Limit of the moving direction</li> <li>• All module reset when a stop error occurs*3</li> <li>• All outputs disabled (SM8034)</li> <li>• Positioning address error</li> <li>• Deceleration stop after the command speed is changed to 0</li> <li>• Table shift cannot be completed in time</li> </ul>	From when pulse output of the specified positioning address is completed or when deceleration stop is started by an interrupt input to when the ON → OFF condition is met	From when the following operation or function is completed to when the ON → OFF condition is met <ul style="list-style-type: none"> <li>• The axis is already used.</li> <li>• The drive contact is turned off during positioning operation</li> <li>• Pulse output stop command</li> <li>• Pulse decelerate and stop command*2</li> <li>• Limit of the moving direction</li> <li>• All module reset when a stop error occurs*3</li> <li>• All outputs disabled (SM8034)</li> <li>• Online change</li> <li>• Positioning address error</li> <li>• Deceleration stop after the command speed is changed to 0</li> <li>• Table shift cannot be completed in time</li> </ul>
ON → OFF condition	When the drive contact is turned off		The flag remains on until either of the following is performed. <ul style="list-style-type: none"> <li>• Turning off the flag by the user</li> <li>• Restarting the table instruction</li> <li>• Shift to the next table</li> </ul>	

\*1 The flag turns on only for one scan when the drive contact of the instruction turns from OFF to ON.

\*2 When remaining distance operation enabled is turn on, abnormal end flag is not turn on. ( Page 385 Remaining distance operation enabled)

\*3 Only high-speed pulse input/output module is supported.

## Condition Jump

The following describes control method [10: Condition Jump].

### Setting data

The following table shows the operand assignment.

Item	Operand 1	Operand 2	Operand 3*1	Operand 4
Description	None	None	Jump Destination Table No.	M No. for Jump Condition
Range	—	—	1 to 100	0 to 32767
Details	None	None	Specify the table number of the jump destination when the jump condition is met.	Specify the number of the internal relay (M) of the jump condition.

\*1 When user devices are used, the value can be changed during positioning operation. When at table three tables or more before the table to be changed in stepping operation or continuous operation, the change is applied at the next scan.

### Processing details

The table to be executed next can be selected using conditions. When the jump condition internal relay (M) specified in operand 4 is ON at condition judgment, positioning of the table number of the jump destination specified in operand 3 is performed. When the jump condition is off, the table with the following number is executed. Operations after the jump all follow the jump-destination tables.

In addition, this table can be specified for continuous operation. ( Page 521 Continuous operation)

## Precautions

- When this table specified for last table, jump is not executed and operation ends normally after deceleration stop.
- In stepping operation, conditions are judged at completion of execution of the table immediately prior to control method [10: Condition Jump], and the jump destination table is immediately executed.
- In continuous operation, conditions are judged when execution of that table two tables before is started. When the jump-destination table is set to control method [10: Condition Jump], the conditions for that table are simultaneously judged and the next destination table is executed.
- If the table is located two or fewer tables before (after the condition is determined), the change is applied, but the condition jump is executed using the settings from when the condition was determined.
- Jumps to the table set to control method [10: Condition Jump] must be three times or less in a row. After the fourth jump, execution is stopped.

## Related devices

Related devices of axis 4 are available only for the FX5S/FX5U/FX5UC CPU module.

### ■Special relays

- CPU module

Axis 1	Axis 2	Axis 3	Axis 4	Name	High speed I/O parameter	R/W	Reference
SM5916	SM5917	SM5918	SM5919	Positioning table data initialization disable	×	R/W	Page 397

R/W: Read/write, ×: Not supported

- High-speed pulse input/output module

First module		Second module		Third module		Fourth module		Name	High speed I/O parameter	R/W	Reference
Axis 5	Axis 6	Axis 7	Axis 8	Axis 9	Axis 10	Axis 11	Axis 12				
SM5920	SM5921	SM5922	SM5923	SM5924	SM5925	SM5926	SM5927	Positioning table data initialization disable	×	R/W	Page 397

R/W: Read/write, ×: Not supported

### ■Special registers

- CPU module

Axis 1	Axis 2	Axis 3	Axis 4	Name	High speed I/O parameter	R/W	Reference
SD5506	SD5546	SD5586	SD5626	Positioning execution table number	×	R	Page 396
SD5511	SD5551	SD5591	SD5631	Positioning error (error occurrence table No.)	×	R/W	Page 397

R: Read only, R/W: Read/write, ×: Not supported

- High-speed pulse input/output module

First module		Second module		Third module		Fourth module		Name	High speed I/O parameter	R/W	Reference
Axis 5	Axis 6	Axis 7	Axis 8	Axis 9	Axis 10	Axis 11	Axis 12				
SD5666	SD5706	SD5746	SD5786	SD5826	SD5866	SD5906	SD5946	Positioning execution table number	×	R	Page 396
SD5671	SD5711	SD5751	SD5791	SD5831	SD5871	SD5911	SD5951	Positioning error (error occurrence table No.)	×	R/W	Page 397

R: Read only, R/W: Read/write, ×: Not supported

## Operation of the complete flags

The following describes the operation timings of the complete flags.

Item	FX3 compatible*1 (Effective only at TBL instruction or DRVTBL instruction execution)		User specification (Effective only at DRVTBL instruction or DRVMUL instruction execution)	
	Instruction execution complete flag (SM8029)	Instruction execution abnormal end flag (SM8329)	Instruction execution complete flag	Instruction execution abnormal end flag
ON condition	From when the condition jump is executed in the last table to when the drive contact is turned off	When jump destination table No. error occurs	From when the condition jump is executed in the last table	When jump destination table No. error occurs
ON → OFF condition	When the normal end condition is not met	When the abnormal end condition is not met	When instruction is driven	

\*1 Operate only when at last table.

## Interpolation Operation (Relative Address Specification)

The following describes control method [20: Interpolation Operation (Relative Address Specification)]. Only FX5S/FX5U/FX5UC CPU module and high-speed pulse input/output module support interpolation operation.

### Setting data

The following table shows the operand assignment.

Item	Operand 1*1	Operand 2*1	Operand 3*1	Operand 4
Description	Positioning Address	Command Speed	Dwell Time	Axis to be Interpolated
Range	-2147483648 to +2147483647 (User system unit)	1 to 2147483647 (User system unit)	0 to 32767 (ms)	Axis 1 Specification to Axis 4 Specification, 0
Details	Set the relative address within the range of -2147483648 to +2147483647 <sup>2</sup> in pulse.	Set the speed within the range of 1 pps to 200 kpps in pulse. For the FX5S CPU module, set a value 1 pps to 100 kpps.	Dwell time is the time until the complete flag turns on after the positioning address is reached.	For the CPU module, specify the axis number of the interpolation counterpart. In the case of the high-speed pulse input/output module, the reference-axis is fixed as the smaller number in the same module and the counterpart axis is fixed as the larger number, so specify 0.

\*1 When the positioning table data is set to use device, the value can be changed during positioning operation. The change is applied when the table operation instruction is restarted.

\*2 Set the number of output pulses per table execution to 2147483647 or lower.

## Processing details

Using the reference axis (control method [20: Interpolation Operation (Relative Address Specification)]) and counterpart axis (control method [21: Interpolation Operation (Relative Address Specification Target Axis)]), which is specified in operand 4, linear interpolation positioning is performed. The transfer distance of the operation is the distance from the current stop position (start address) to the positioning addresses specified in operand 1 of the reference axis and the counterpart axis. (☞ Page 513 Interpolation Operation (Relative Address Specification Target Axis)) For the counterpart axis specified in operand 1, [21: Interpolation Operation (Relative Address Specification Target Axis)] is assigned as the control method in the same table number as that for the reference axis. If dwell time is set, the complete flag turns on after the dwell time elapses. (☞ Page 400 Complete flag)

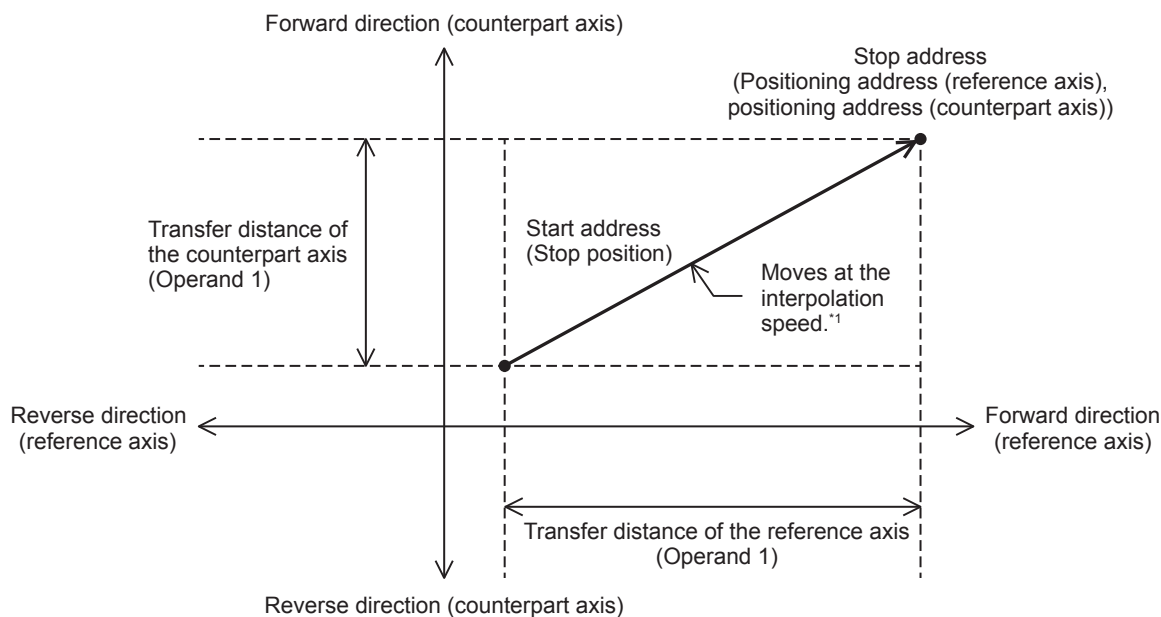

\*1 The calculation method differs depending on the specification method for the interpolation speed. (☞ Page 395 Interpolation Speed Specified Method)

## Precautions

- This table cannot be specified for continuous operation. When a table with this control method is executed in continuous operation, the operation is decelerated to a stop.
- When the specification method for the interpolation speed is [Reference-axis speed], set the axis with the longer positioning address as the reference axis. If the axis with the shorter positioning address is set as the reference axis, the speed of the longer axis may exceed the maximum speed and interpolation operation cannot be performed properly.
- When forward limit or reverse limit is detected in either of the reference axis or counterpart axis during interpolation operation, both the axes are decelerated to a stop.
- Do not change the value of operand 4.
- This function is not intended for purposes where high precision path is required because each axis is only started simultaneously.

Using the following or similar set values, in particular, may lead to a larger difference in stop time between each axis. Even when there is a difference in stop time, operation stops at the correct position.

1. When there is a large difference in transfer distance between the reference axis and counterpart axis
2. When the speed of the reference axis or counterpart axis is equal to or lower than the bias speed or exceeds the maximum speed
3. When the speeds of the reference axis and counterpart axis are extremely slow
4. When an extremely long acceleration time or deceleration time is set

If interpolation operation is aborted, the stop position of each axis may be off the straight line.

- If interpolation operation specified with a relative address is repeatedly used in machine or multiple unit system, calculation errors may accumulate for each axis.



## Related devices

### ■ Special relays

- CPU module

FX5 dedicated				FX3 compatible				Name	High speed I/O parameter	R/W	Reference
Axis 1	Axis 2	Axis 3	Axis 4	Axis 1	Axis 2	Axis 3	Axis 4				
—	—	—	—	SM8029				Instruction execution complete flag	×	R	Page 400
—	—	—	—	SM8329				Instruction execution abnormal end flag	×	R	
SM5500	SM5501	SM5502	SM5503	SM8348	SM8358	SM8368	SM8378	Positioning instruction activation	×	R	Page 398
SM5516	SM5517	SM5518	SM5519	SM8340	SM8350	SM8360	SM8370	Pulse output monitor	×	R	Page 398
SM5532	SM5533	SM5534	SM5535	—	—	—	—	Positioning error occurrence	×	R/W	Page 398
SM5628	SM5629	SM5630	SM5631	—	—	—	—	Pulse output stop command	×	R/W	Page 382
SM5644	SM5645	SM5646	SM5647	—	—	—	—	Pulse decelerate and stop command	×	R/W	Page 383
SM5660	SM5661	SM5662	SM5663	—	—	—	—	Forward limit	×	R/W	Page 384
SM5676	SM5677	SM5678	SM5679	—	—	—	—	Reverse limit	×	R/W	Page 384
SM5772	SM5773	SM5774	SM5775	—	—	—	—	Rotation direction setting	○	R/W	Page 372
SM5916	SM5917	SM5918	SM5919	—	—	—	—	Positioning table data initialization disable	×	R/W	Page 397

R: Read only, R/W: Read/write, ○: Supported, ×: Not supported

- High-speed pulse input/output module

First module		Second module		Third module		Fourth module		Name	High speed I/O parameter	R/W	Reference
Axis 5	Axis 6	Axis 7	Axis 8	Axis 9	Axis 10	Axis 11	Axis 12				
SM8029 (FX3 compatible device)								Instruction execution complete flag	×	R	Page 400
SM8329 (FX3 compatible device)								Instruction execution abnormal end flag	×	R	
SM5504	SM5505	SM5506	SM5507	SM5508	SM5509	SM5510	SM5511	Positioning instruction activation	×	R	Page 398
SM5520	SM5521	SM5522	SM5523	SM5524	SM5525	SM5526	SM5527	Pulse output monitor	×	R	Page 398
SM5536	SM5537	SM5538	SM5539	SM5540	SM5541	SM5542	SM5543	Positioning error occurrence	×	R/W	Page 398
SM5632	SM5633	SM5634	SM5635	SM5636	SM5637	SM5638	SM5639	Pulse output stop command	×	R/W	Page 382
SM5648	SM5649	SM5650	SM5651	SM5652	SM5653	SM5654	SM5655	Pulse decelerate and stop command	×	R/W	Page 383
SM5664	SM5665	SM5666	SM5667	SM5668	SM5669	SM5670	SM5671	Forward limit	×	R/W	Page 384
SM5680	SM5681	SM5682	SM5683	SM5684	SM5685	SM5686	SM5687	Reverse limit	×	R/W	Page 384
SM5776	SM5777	SM5778	SM5779	SM5780	SM5781	SM5782	SM5783	Rotation direction setting	○	R/W	Page 372
SM5920	SM5921	SM5922	SM5923	SM5924	SM5925	SM5926	SM5927	Positioning table data initialization disable	×	R/W	Page 397

R: Read only, R/W: Read/write, ○: Supported, ×: Not supported

## ■ Special registers

### • CPU module

FX5 dedicated				FX3 compatible				Name	High speed I/O parameter	R/W	Reference
Axis 1	Axis 2	Axis 3	Axis 4	Axis 1	Axis 2	Axis 3	Axis 4				
SD5500, SD5501	SD5540, SD5541	SD5580, SD5581	SD5620, SD5621	—	—	—	—	Current address (user unit)	×	R/W <sup>*1</sup>	Page 380
SD5502, SD5503	SD5542, SD5543	SD5582, SD5583	SD5622, SD5623	SD8340, SD8341	SD8350, SD8351	SD8360, SD8361	SD8370, SD8371	Current address (pulse unit)	×	R/W <sup>*1</sup>	Page 380
SD5504, SD5505	SD5544, SD5545	SD5584, SD5585	SD5624, SD5625	—	—	—	—	Current speed (user unit)	×	R	Page 376
SD5506	SD5546	SD5586	SD5626	—	—	—	—	Positioning execution table number	×	R	Page 396
SD5510	SD5550	SD5590	SD5630	—	—	—	—	Positioning error (error code)	×	R/W	Page 399
SD5511	SD5551	SD5591	SD5631	—	—	—	—	Positioning error (error occurrence table No.)	×	R/W	Page 397
SD5516, SD5517	SD5556, SD5557	SD5596, SD5597	SD5636, SD5637	—	—	—	—	Maximum speed	○	R/W	Page 377
SD5518, SD5519	SD5558, SD5559	SD5598, SD5599	SD5638, SD5639	—	—	—	—	Bias speed	○	R/W	Page 377
SD5520	SD5560	SD5600	SD5640	—	—	—	—	Acceleration time	○	R/W	Page 378
SD5521	SD5561	SD5601	SD5641	—	—	—	—	Deceleration time	○	R/W	Page 378

R: Read only, R/W: Read/write, ○: Supported, ×: Not supported

\*1 Only FX5 dedicated devices can be written by the HCMOV/DHCMOV instruction.

### • High-speed pulse input/output module

First module		Second module		Third module		Fourth module		Name	High speed I/O parameter	R/W	Reference
Axis 5	Axis 6	Axis 7	Axis 8	Axis 9	Axis 10	Axis 11	Axis 12				
SD5660, SD5661	SD5700, SD5701	SD5740, SD5741	SD5780, SD5781	SD5820, SD5821	SD5860, SD5861	SD5900, SD5901	SD5940, SD5941	Current address (user unit)	×	R/W <sup>*1</sup>	Page 380
SD5662, SD5663	SD5702, SD5703	SD5742, SD5743	SD5782, SD5783	SD5822, SD5823	SD5862, SD5863	SD5902, SD5903	SD5942, SD5943	Current address (pulse unit)	×	R/W <sup>*1</sup>	Page 380
SD5664, SD5665	SD5704, SD5705	SD5744, SD5745	SD5784, SD5785	SD5824, SD5825	SD5864, SD5865	SD5904, SD5905	SD5944, SD5945	Current speed (user unit)	×	R	Page 376
SD5666	SD5706	SD5746	SD5786	SD5826	SD5866	SD5906	SD5946	Positioning execution table number	×	R	Page 396
SD5668, SD5669	SD5708, SD5709	SD5748, SD5749	SD5788, SD5789	SD5828, SD5829	SD5868, SD5869	SD5908, SD5909	SD5948, SD5949	Current speed (composite speed)	×	R	Page 396
SD5670	SD5710	SD5750	SD5790	SD5830	SD5870	SD5910	SD5950	Positioning error (error code)	×	R/W	Page 399
SD5671	SD5711	SD5751	SD5791	SD5831	SD5871	SD5911	SD5951	Positioning error (error occurrence table No.)	×	R/W	Page 397
SD5676, SD5677	SD5716, SD5717	SD5756, SD5757	SD5796, SD5797	SD5836, SD5837	SD5876, SD5877	SD5916, SD5917	SD5956, SD5957	Maximum speed	○	R/W	Page 377
SD5678, SD5679	SD5718, SD5719	SD5758, SD5759	SD5798, SD5799	SD5838, SD5839	SD5878, SD5879	SD5918, SD5919	SD5958, SD5959	Bias speed	○	R/W	Page 377
SD5680	SD5720	SD5760	SD5800	SD5840	SD5880	SD5920	SD5960	Acceleration time	○	R/W	Page 378
SD5681	SD5721	SD5761	SD5801	SD5841	SD5881	SD5921	SD5961	Deceleration time	○	R/W	Page 378

R: Read only, R/W: Read/write, ○: Supported, ×: Not supported

\*1 Writing can be performed only by the HCMOV/DHCMOV instruction.

## Operation of the complete flags

The following describes the operation timings of the complete flags.  
If dwell time is specified, the flag turns on after the dwell time elapses.

Item	FX3 compatible (Effective only at TBL instruction or DRVTBL instruction execution)		User specification (Effective only at DRVTBL instruction or DRVMUL instruction execution)	
	Instruction execution complete flag (SM8029)	Instruction execution abnormal end flag (SM8329)	Instruction execution complete flag	Instruction execution abnormal end flag
ON condition	From when pulse output of the specified positioning address is completed to when the drive contact is turned off	From when the following operation or function is completed to when the drive contact is turned off <ul style="list-style-type: none"> <li>• Either the reference axis or counterpart axis is already used.*1</li> <li>• Pulse output stop command</li> <li>• Pulse decelerate and stop command</li> <li>• Limit of the moving direction</li> <li>• All module reset when a stop error occurs*2</li> <li>• All outputs disabled (SM8034)</li> <li>• Positioning address error</li> <li>• Deceleration stop after the command speed is changed to 0</li> </ul>	From when pulse output of the specified positioning address is completed to when the ON → OFF condition is met	From when the following operation or function is completed to when the ON → OFF condition is met <ul style="list-style-type: none"> <li>• Either the reference axis or counterpart axis is already used.</li> <li>• The drive contact is turned off during positioning operation</li> <li>• Pulse output stop command</li> <li>• Pulse decelerate and stop command</li> <li>• Limit of the moving direction</li> <li>• All module reset when a stop error occurs*2</li> <li>• All outputs disabled (SM8034)</li> <li>• Online change</li> <li>• Positioning address error</li> <li>• Deceleration stop after the command speed is changed to 0</li> </ul>
ON → OFF condition	When the drive contact is turned off		The flag remains on until either of the following is performed. <ul style="list-style-type: none"> <li>• Turning off the flag by the user</li> <li>• Restarting the table instruction</li> <li>• Shift to the next table</li> </ul>	

\*1 The flag turns on only for one scan when the drive contact of the instruction turns from OFF to ON.

\*2 Only high-speed pulse input/output module is supported.

## Interpolation Operation (Relative Address Specification Target Axis)

The following describes control method [21: Interpolation Operation (Relative Address Specification Target Axis)]. Only FX5S/FX5U/FX5UC CPU module and high-speed pulse input/output module support interpolation operation.

### Setting data

The following table shows the operand assignment.

Item	Operand 1*1	Operand 2	Operand 3	Operand 4
Description	Positioning Address	None	None	None
Range	-2147483648 to +2147483647 (User system unit)	—	—	—
Details	Set the relative address within the range of -2147483648 to +2147483647*2 in pulse.	None	None	None

\*1 When the positioning table data is set to use device, the value can be changed during positioning operation. The change is applied when the table operation instruction is restarted.

\*2 Set the number of output pulses per table execution to 2147483647 or lower.

### Processing details

[21: Interpolation Operation (Relative Address Specification Target Axis)] is assigned to the same table number as that for control method [20: Interpolation Operation (Relative Address Specification)] specified in the interpolation reference axis.

For the interpolation operation, refer to  Page 509 Interpolation Operation (Relative Address Specification).

## Precautions

- Interpolation operation cannot be activated from this table. Drive interpolation operation with the table control method [20: Interpolation Operation (Relative Address Specification)] of the reference axis.
- Each speed is calculated based on the speed of the reference axis.

## Related devices

Refer to  Page 511 Related devices of control method [20: Interpolation Operation (Relative Address Specification)].

## Operation of the complete flags

Refer to  Page 513 Operation of the complete flags of control method [20: Interpolation Operation (Relative Address Specification)].

## Interpolation Operation (Absolute Address Specification)

The following describes control method [22: Interpolation Operation (Absolute Address Specification)]. Only FX5S/FX5U/FX5UC CPU module and high-speed pulse input/output module support interpolation operation.

## Setting data

The following table shows the operand assignment.

Item	Operand 1 <sup>*1</sup>	Operand 2 <sup>*1</sup>	Operand 3 <sup>*1</sup>	Operand 4
Description	Positioning Address	Command Speed	Dwell Time	Axis to be Interpolated
Range	-2147483648 to +2147483647 (User system unit)	1 to 2147483647 (User system unit)	0 to 32767 (ms)	Axis 1 Specification to Axis 4 Specification, 0
Details	Set the absolute address within the range of -2147483648 to +2147483647 <sup>*2</sup> in pulse.	Set the speed within the range of 1 pps to 200 kpps in pulse. For the FX5S CPU module, set a value 1 pps to 100 kpps.	Dwell time is the time until the complete flag turns on after the positioning address is reached.	For the CPU module, specify the axis number of the interpolation counterpart. In the case of the high-speed pulse input/output module, the reference-axis is fixed as the smaller number in the same module and the counterpart axis is fixed as the larger number, so specify 0.

\*1 When the positioning table data is set to use device, the value can be changed during positioning operation. The change is applied when the table operation instruction is restarted.

\*2 Set the number of output pulses per table execution to 2147483647 or lower.

## Processing details

Using the reference axis (control method [22: Interpolation Operation (Absolute Address Specification)]) and counterpart axis (control method [23: Interpolation Operation (Absolute Address Specification Target Axis)]), which is specified in operand 4, linear interpolation positioning is performed. The transfer distance of the operation is the distance from the current stop position (start address) to the positioning addresses specified in operand 1 of the reference axis and the counterpart axis. (☞ Page 518 Interpolation Operation (Absolute Address Specification Target Axis)) For the counterpart axis specified in operand 1, [23: Interpolation Operation (Relative Absolute Specification Target Axis)] is assigned as the control method in the same table number as that for the reference axis. If dwell time is set, the complete flag turns on after the dwell time elapses. (☞ Page 400 Complete flag)

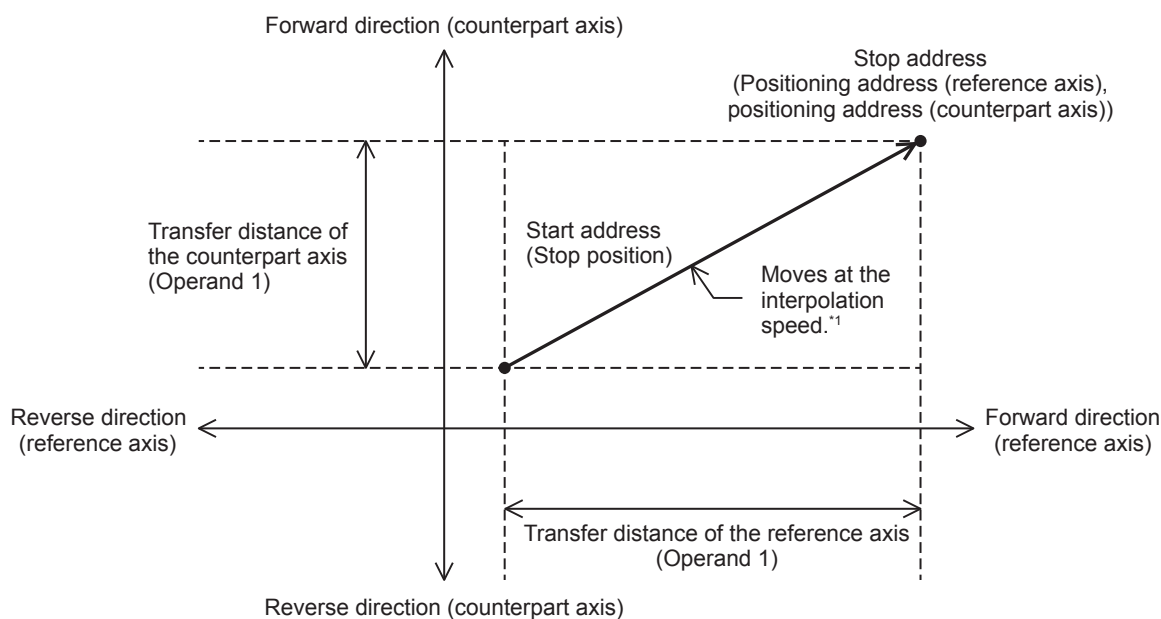

\*1 The calculation method differs depending on the specification method for the interpolation speed. (☞ Page 395 Interpolation Speed Specified Method)

## Precautions

- This table cannot be specified for continuous operation. When a table with this control method is executed in continuous operation, the operation is decelerated to a stop.
- When the specification method for the interpolation speed is [Reference-axis speed], set the axis with the longer positioning address as the reference axis. If the axis with the shorter positioning address is set as the reference axis, the speed of the longer axis may exceed the maximum speed and interpolation operation cannot be performed properly.
- When such as forward limit or reverse limit, is detected in either of the reference axis or counterpart axis during interpolation operation, both the axes are decelerated to a stop.
- Do not change the value of operand 4.
- This function is not intended for purposes where high precision path is required because each axis is only started simultaneously.

Using the following or similar set values, in particular, may lead to a larger difference in stop time between each axis. Even when there is a difference in stop time, operation stops at the correct position.

1. When there is a large difference in transfer distance between the reference axis and counterpart axis
2. When the speed of the reference axis or counterpart axis is equal to or lower than the bias speed or exceeds the maximum speed
3. When the speeds of the reference axis and counterpart axis are extremely slow
4. When an extremely long acceleration time or deceleration time is set

If interpolation operation is aborted, the stop position of each axis may be off the straight line.

## Related devices

### ■ Special relays

- CPU module

FX5 dedicated				FX3 compatible				Name	High speed I/O parameter	R/W	Reference
Axis 1	Axis 2	Axis 3	Axis 4	Axis 1	Axis 2	Axis 3	Axis 4				
—	—	—	—	SM8029				Instruction execution complete flag	×	R	Page 400
—	—	—	—	SM8329				Instruction execution abnormal end flag	×	R	
SM5500	SM5501	SM5502	SM5503	SM8348	SM8358	SM8368	SM8378	Positioning instruction activation	×	R	Page 398
SM5516	SM5517	SM5518	SM5519	SM8340	SM8350	SM8360	SM8370	Pulse output monitor	×	R	Page 398
SM5532	SM5533	SM5534	SM5535	—	—	—	—	Positioning error occurrence	×	R/W	Page 398
SM5628	SM5629	SM5630	SM5631	—	—	—	—	Pulse output stop command	×	R/W	Page 382
SM5644	SM5645	SM5646	SM5647	—	—	—	—	Pulse decelerate and stop command	×	R/W	Page 383
SM5660	SM5661	SM5662	SM5663	—	—	—	—	Forward limit	×	R/W	Page 384
SM5676	SM5677	SM5678	SM5679	—	—	—	—	Reverse limit	×	R/W	Page 384
SM5772	SM5773	SM5774	SM5775	—	—	—	—	Rotation direction setting	○	R/W	Page 372
SM5916	SM5917	SM5918	SM5919	—	—	—	—	Positioning table data initialization disable	×	R/W	Page 397

R: Read only, R/W: Read/write, ○: Supported, ×: Not supported

- High-speed pulse input/output module

First module		Second module		Third module		Fourth module		Name	High speed I/O parameter	R/W	Reference
Axis 5	Axis 6	Axis 7	Axis 8	Axis 9	Axis 10	Axis 11	Axis 12				
SM8029 (FX3 compatible device)								Instruction execution complete flag	×	R	Page 400
SM8329 (FX3 compatible device)								Instruction execution abnormal end flag	×	R	
SM5504	SM5505	SM5506	SM5507	SM5508	SM5509	SM5510	SM5511	Positioning instruction activation	×	R	Page 398
SM5520	SM5521	SM5522	SM5523	SM5524	SM5525	SM5526	SM5527	Pulse output monitor	×	R	Page 398
SM5536	SM5537	SM5538	SM5539	SM5540	SM5541	SM5542	SM5543	Positioning error occurrence	×	R/W	Page 398
SM5632	SM5633	SM5634	SM5635	SM5636	SM5637	SM5638	SM5639	Pulse output stop command	×	R/W	Page 382
SM5648	SM5649	SM5650	SM5651	SM5652	SM5653	SM5654	SM5655	Pulse decelerate and stop command	×	R/W	Page 383
SM5664	SM5665	SM5666	SM5667	SM5668	SM5669	SM5670	SM5671	Forward limit	×	R/W	Page 384
SM5680	SM5681	SM5682	SM5683	SM5684	SM5685	SM5686	SM5687	Reverse limit	×	R/W	Page 384
SM5776	SM5777	SM5778	SM5779	SM5780	SM5781	SM5782	SM5783	Rotation direction setting	○	R/W	Page 372
SM5920	SM5921	SM5922	SM5923	SM5924	SM5925	SM5926	SM5927	Positioning table data initialization disable	×	R/W	Page 397

R: Read only, R/W: Read/write, ○: Supported, ×: Not supported

## Special registers

### • CPU module

FX5 dedicated				FX3 compatible				Name	High speed I/O parameter	R/W	Reference
Axis 1	Axis 2	Axis 3	Axis 4	Axis 1	Axis 2	Axis 3	Axis 4				
SD5500, SD5501	SD5540, SD5541	SD5580, SD5581	SD5620, SD5621	—	—	—	—	Current address (user unit)	×	R/W <sup>*1</sup>	Page 380
SD5502, SD5503	SD5542, SD5543	SD5582, SD5583	SD5622, SD5623	SD8340, SD8341	SD8350, SD8351	SD8360, SD8361	SD8370, SD8371	Current address (pulse unit)	×	R/W <sup>*1</sup>	Page 380
SD5504, SD5505	SD5544, SD5545	SD5584, SD5585	SD5624, SD5625	—	—	—	—	Current speed (user unit)	×	R	Page 376
SD5506	SD5546	SD5586	SD5626	—	—	—	—	Positioning execution table number	×	R	Page 396
SD5510	SD5550	SD5590	SD5630	—	—	—	—	Positioning error (error code)	×	R/W	Page 399
SD5511	SD5551	SD5591	SD5631	—	—	—	—	Positioning error (error occurrence table No.)	×	R/W	Page 397
SD5516, SD5517	SD5556, SD5557	SD5596, SD5597	SD5636, SD5637	—	—	—	—	Maximum speed	○	R/W	Page 377
SD5518, SD5519	SD5558, SD5559	SD5598, SD5599	SD5638, SD5639	—	—	—	—	Bias speed	○	R/W	Page 377
SD5520	SD5560	SD5600	SD5640	—	—	—	—	Acceleration time	○	R/W	Page 378
SD5521	SD5561	SD5601	SD5641	—	—	—	—	Deceleration time	○	R/W	Page 378

R: Read only, R/W: Read/write, ○: Supported, ×: Not supported

\*1 Only FX5 dedicated devices can be written by the HCMOV/DHCMOV instruction.

### • High-speed pulse input/output module

First module		Second module		Third module		Fourth module		Name	High speed I/O parameter	R/W	Reference
Axis 5	Axis 6	Axis 7	Axis 8	Axis 9	Axis 10	Axis 11	Axis 12				
SD5660, SD5661	SD5700, SD5701	SD5740, SD5741	SD5780, SD5781	SD5820, SD5821	SD5860, SD5861	SD5900, SD5901	SD5940, SD5941	Current address (user unit)	×	R/W <sup>*1</sup>	Page 380
SD5662, SD5663	SD5702, SD5703	SD5742, SD5743	SD5782, SD5783	SD5822, SD5823	SD5862, SD5863	SD5902, SD5903	SD5942, SD5943	Current address (pulse unit)	×	R/W <sup>*1</sup>	Page 380
SD5664, SD5665	SD5704, SD5705	SD5744, SD5745	SD5784, SD5785	SD5824, SD5825	SD5864, SD5865	SD5904, SD5905	SD5944, SD5945	Current speed (user unit)	×	R	Page 376
SD5666	SD5706	SD5746	SD5786	SD5826	SD5866	SD5906	SD5946	Positioning execution table number	×	R	Page 396
SD5668, SD5669	SD5708, SD5709	SD5748, SD5749	SD5788, SD5789	SD5828, SD5829	SD5868, SD5869	SD5908, SD5909	SD5948, SD5949	Current speed (composite speed)	×	R	Page 396
SD5670	SD5710	SD5750	SD5790	SD5830	SD5870	SD5910	SD5950	Positioning error (error code)	×	R/W	Page 399
SD5671	SD5711	SD5751	SD5791	SD5831	SD5871	SD5911	SD5951	Positioning error (error occurrence table No.)	×	R/W	Page 397
SD5676, SD5677	SD5716, SD5717	SD5756, SD5757	SD5796, SD5797	SD5836, SD5837	SD5876, SD5877	SD5916, SD5917	SD5956, SD5957	Maximum speed	○	R/W	Page 377
SD5678, SD5679	SD5718, SD5719	SD5758, SD5759	SD5798, SD5799	SD5838, SD5839	SD5878, SD5879	SD5918, SD5919	SD5958, SD5959	Bias speed	○	R/W	Page 377
SD5680	SD5720	SD5760	SD5800	SD5840	SD5880	SD5920	SD5960	Acceleration time	○	R/W	Page 378
SD5681	SD5721	SD5761	SD5801	SD5841	SD5881	SD5921	SD5961	Deceleration time	○	R/W	Page 378

R: Read only, R/W: Read/write, ○: Supported, ×: Not supported

\*1 Writing can be performed only by the HCMOV/DHCMOV instruction.

## Operation of the complete flags

The following describes the operation timings of the complete flags.

If dwell time is specified, the flag turns on after the dwell time elapses.

Item	FX3 compatible (Effective only at TBL instruction or DRVTBL instruction execution)		User specification (Effective only at DRVTBL instruction or DRVMUL instruction execution)	
	Instruction execution complete flag (SM8029)	Instruction execution abnormal end flag (SM8329)	Instruction execution complete flag	Instruction execution abnormal end flag
ON condition	From when pulse output of the specified positioning address is completed to when the drive contact is turned off	From when the following operation or function is completed to when the drive contact is turned off <ul style="list-style-type: none"> <li>• Either the reference axis or counterpart axis is already used.*1</li> <li>• Pulse output stop command</li> <li>• Pulse decelerate and stop command</li> <li>• Limit of the moving direction</li> <li>• All module reset when a stop error occurs*2</li> <li>• All outputs disabled (SM8034)</li> <li>• Positioning address error</li> <li>• Deceleration stop after the command speed is changed to 0</li> </ul>	From when pulse output of the specified positioning address is completed to when the ON → OFF condition is met	From when the following operation or function is completed to when the ON → OFF condition is met <ul style="list-style-type: none"> <li>• Either the reference axis or counterpart axis is already used.</li> <li>• The drive contact is turned off during positioning operation</li> <li>• Pulse output stop command</li> <li>• Pulse decelerate and stop command</li> <li>• Limit of the moving direction</li> <li>• All module reset when a stop error occurs*2</li> <li>• All outputs disabled (SM8034)</li> <li>• Online change</li> <li>• Positioning address error</li> <li>• Deceleration stop after the command speed is changed to 0</li> </ul>
ON → OFF condition	When the drive contact is turned off		The flag remains on until either of the following is performed. <ul style="list-style-type: none"> <li>• Turning off the flag by the user</li> <li>• Restarting the table instruction</li> <li>• Shift to the next table</li> </ul>	

\*1 The flag turns on only for one scan when the drive contact of the instruction turns from OFF to ON.

\*2 Only high-speed pulse input/output module is supported.

## Interpolation Operation (Absolute Address Specification Target Axis)

The following describes control method [23: Interpolation Operation (Absolute Address Specification Target Axis)]. Only FX5S/FX5U/FX5UC CPU module and high-speed pulse input/output module support interpolation operation.

### Setting data

The following table shows the operand assignment.

Item	Operand 1*1	Operand 2	Operand 3	Operand 4
Description	Positioning Address	None	None	None
Range	-2147483648 to +2147483647 (User system unit)	—	—	—
Details	Set the relative address within the range of -2147483648 to +2147483647*2 in pulse.	None	None	None

\*1 When the positioning table data is set to use device, the value can be changed during positioning operation. The change is applied when the table operation instruction is restarted.

\*2 Set the number of output pulses per table execution to 2147483647 or lower.

### Processing details

[23: Interpolation Operation (Absolute Address Specification Target Axis)] is assigned to the same table number as that for control method [22: Interpolation Operation (Absolute Address Specification)] specified in the interpolation reference axis.

For the interpolation operation, refer to  Page 514 Interpolation Operation (Absolute Address Specification).



## Precautions

- Interpolation operation cannot be activated from this table. Drive interpolation operation with the table control method [22: Interpolation Operation (Absolute Address Specification)] of the reference axis.
- Each speed is calculated based on the speed of the reference axis.

## Related devices

Refer to  Page 516 Related devices of control method [22: Interpolation Operation (Absolute Address Specification)].

## Operation of the complete flags

Refer to  Page 518 Operation of the complete flags of control method [22: Interpolation Operation (Absolute Address Specification)].

# 33.3 How to Execute Multiple Tables

The execution method for multiple tables of the DRVTBL and DRVMUL instructions includes stepping operation and continuous operation.

This section describes how to execute each operation.

## Stepping operation

In stepping operation, with the DRVTBL instruction, specified tables are executed one by one. Only the DRVTBL instruction can execute this operation.

Every time a table ends, the complete flag turns on and the next table is not automatically activated. After the table shift command or external start signal is detected, the next table is executed. ( Page 396 Table shift command, Page 383 External Start Signal)

The following figure shows an example of stepping operation with the tables 1 to 3 and dwell time.

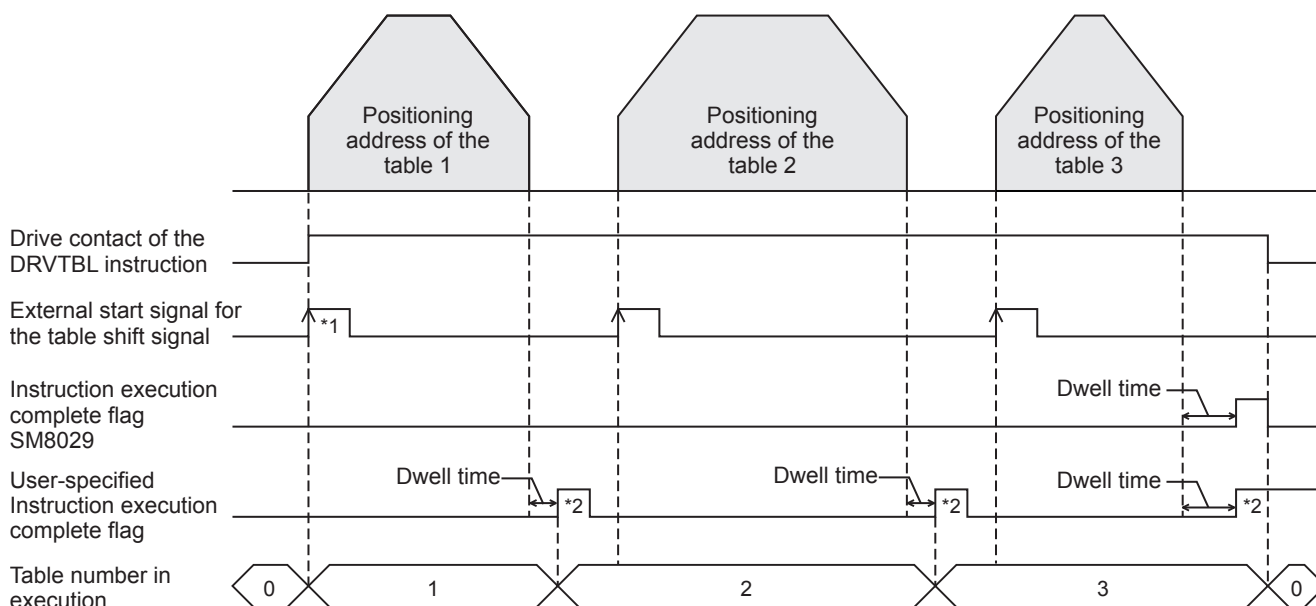

\*1 When the external start signal is enabled, the drive contact and external start signal must be turned on to activate the positioning instruction.

\*2 Remains on until the user turns off the flag or starts the next table.

## Operation

The following describes the operation of tables and flags in the stepping operation.

### ■Operation of the table

- Operation of each table in the stepping operation is the same as that of one-table operation.
- When a table with control method [0: No Positioning] is executed, or when the last table specified by the DRVTBL instruction is executed, execution of all the tables is completed. When the first table is greater than the last table, execution of all the tables is completed either when all the tables are executed or when control method [0: No Positioning] is executed.
- Even if the table shift command or external start signal is turned on before a table is completed, the next table is not activated. By turning on the table shift command or external start signal after the previous table is completed, the next table is executed.
- If the operation ends with an error when tables to be executed are left, the rest of the tables are not executed.
- Regardless whether the operation ends with or without errors, operation is started from the first table every time the instruction is turned on. The operation is not restarted from the last table of the previous operation.
- Some control methods can be used with the remaining distance operation. (  Page 362 Remaining distance operation)

### ■Operations by control method

- When a table with control method [0: No Positioning] is executed, all the tables are considered to be normally completed. Then, the complete flag turns on, and tables that follow the table with [0: No Positioning] are not executed.
- For control method [10: Condition Jump], the conditions are judged at execution of the table, and the table with the next number is immediately executed. (The judgment timing differs from that in continuous operation.)
- For control method [4: Variable Speed Operation] and control method [5: Table Transition Variable Speed Operation], after the pulse decelerate and stop command is detected, deceleration stop is performed, and the complete flag turns on after dwell time. Then, the next table becomes ready to be executed. For control method [5: Table Transition Variable Speed Operation], inputting the interrupt input signal 2 starts deceleration stop and enables the next table to be ready, in addition to the pulse decelerate and stop command.

### ■Operation of the flag

The user-specified positioning complete flag turns on for every table. (  Page 400 Complete flag) The complete flag that is on must be turned off by the user or turns off when execution of the next table is started. Instruction execution abnormal end flag (SM8029) turns on when execution of all the tables is completed.

### ■Operation with table (operand) setting

- Operands can be changed in mid-operation, similar to the one-table operation.
- Both absolute address and relative address can be used.

## Compatible control method

The following table lists operation of control methods of each table when stepping operation is specified.

Control method	Operation	Reference
0: No Positioning	When this type is specified, no pulses are output. The operation ends normally.	Page 490
1: 1 Speed Positioning (Relative Address Specification)	The table operates normally.	Page 491
2: 1 Speed Positioning (Absolute Address Specification)	The table operates normally.	Page 493
3: Interrupt 1 Speed Positioning	The table operates normally.	Page 495
4: Variable Speed Operation	The table operates normally.	Page 498
5: Table Transition Variable Speed Operation <sup>*1</sup>	The table operates normally.	Page 500
6: Interrupt Stop (Relative Address Specification)	The table operates normally.	Page 502
7: Interrupt Stop (Absolute Address Specification)	The table operates normally.	Page 505
10: Condition Jump	Depends on the jump-destination table.	Page 507
20: Interpolation Operation (Relative Address Specification) <sup>*2</sup>	The table operates normally.	Page 509
21: Interpolation Operation (Relative Address Specification Target Axis) <sup>*2</sup>	When this type is specified, no pulses are output. The operation ends with an error.	Page 513
22: Interpolation Operation (Absolute Address Specification) <sup>*2</sup>	The table operates normally.	Page 514
23: Interpolation Operation (Absolute Address Specification Target Axis) <sup>*2</sup>	When this type is specified, no pulses are output. The operation ends with an error.	Page 518

\*1 Only CPU module is supported.

\*2 Only FX5S/FX5U/FX5UC CPU module and high-speed pulse input/output module support interpolation operation.

## Continuous operation

In continuous operation, operation is performed successively without deceleration stop between tables. The specified positioning address that has been output is the start address of the next table.

The positioning complete flag turns on when execution of all the specified tables is completed. Unlike stepping operation, the table shift command is not required.

The following figure shows an example of continuous operation with tables 1 to 5 (With dwell time).

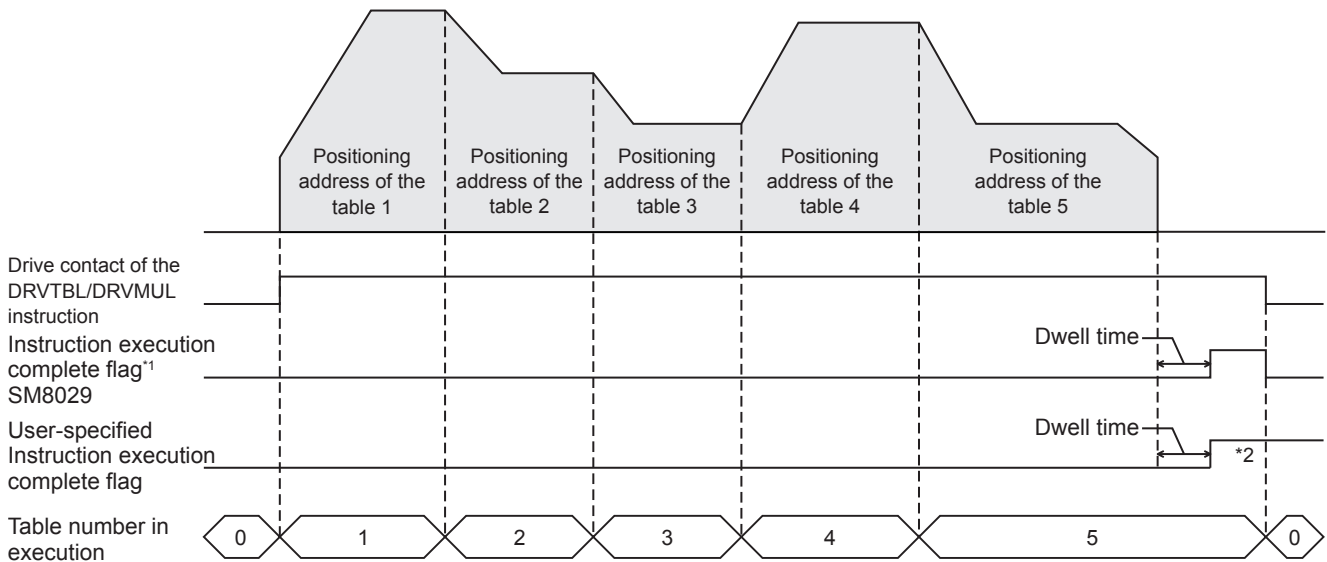

\*1 Only the DRVTBL instruction functions.

\*2 Remains on until the user turns off the flag.

## Operation

The following describes the operation of tables and flags in the continuous operation.

### ■ Operation of the table

- Dwell time of the last table is the time until the complete flag turns on after deceleration stop.
- When tables are executed successively causing a direction change, deceleration stop is performed once and then output is started in the reversed direction. The waiting time for the pulse output in the reversed direction after stop is "1 ms + scan time".
- If the operation ends with an error when tables to be executed are left, the rest of the tables are not executed.
- If a table that cannot be combined is executed, the operation ends with an error. In this case, the table before the table that cannot be combined is handled as the last table. After deceleration stop is performed for the previous table and dwell time elapses, the abnormal end flag turns on. The dwell time of the previous table is used.
- Some control methods can be used with the remaining distance operation. (  Page 362 Remaining distance operation)

### ■ Operations by control method

- When a table with control method [0: No Positioning] is executed, all the tables are considered to be normally completed. Then, the positioning complete flag turns on, and tables that follow the table with control method [0: No Positioning] are not executed.
- The jump condition of control method [10: Condition Jump] is judged two tables before. (Example: If table 8 has control method [10: Condition Jump], the conditions are judged when execution of table 6 is started.) When the jump-destination table of control method [10: Condition Jump] has control method [10: Condition Jump], the conditions of control method [10: Condition Jump] of the jump-destination table are judged at the same time.

### ■ Operation with table (operand) setting

- Set the command speeds and positioning addresses of each table so that tables are switched once per 10 ms or less frequently (except conditional jumps). If tables are switched more frequently than the above, table shift processing cannot be completed in time and operation is decelerated to a stop and ends with an error. (The tables that have been read operate normally.)
- The positioning address of the last table only can be changed in the case of continuous operation. Changes in the positioning addresses of tables other than the last table are ignored.
- The positioning address of the last table can be changed both in the address increasing direction and address decreasing direction. When the address is changed in the decreasing direction and the new address has already passed or when pulses required for deceleration stop are insufficient for the new address, pulses are output in the reverse direction after deceleration stop to reach the new positioning address. (The operation is the same as that of the DRVI/DDRVI and DRVA/DDRVA instructions.)

## Compatible control method

The following table lists control methods that can be used when continuous operation is specified.

Continuous operation		Rear table										
		No Positioning	1 Speed Positioning (Relative Address Specification)	1 Speed Positioning (Absolute Address Specification)	Interrupt 1 Speed Positioning* <sup>1</sup>	Variable Speed Operation	Table Transition Variable Speed Operation* <sup>1</sup>	Interrupt Stop (Relative Address Specification)	Interrupt Stop (Absolute Address Specification)	Condition Jump	Interpolation Operation (Relative Address Specification)* <sup>2</sup>	Interpolation Operation (Absolute Address Specification)* <sup>2</sup>
Forward table	0: No Positioning	—	—	—	—	—	—	—	—	—	—	—
	1: 1 Speed Positioning (Relative Address Specification)	○	○	○	×	×	×	○	○	○	×	×
	2: 1 Speed Positioning (Absolute Address Specification)	○	○	○	×	×	×	○	○	○	×	×
	3: Interrupt 1 Speed Positioning* <sup>1</sup>	—	—	—	—	—	—	—	—	—	—	—
	4: Variable Speed Operation	×	×	×	×	×	×	×	×	×	×	×
	5: Table Transition Variable Speed Operation	○	×	×	* <sup>3</sup>	×	○	×	×	○	×	×
	6: Interrupt Stop (Relative Address Specification)	—	—	—	—	—	—	—	—	—	—	—
	7: Interrupt Stop (Absolute Address Specification)	—	—	—	—	—	—	—	—	—	—	—
	10: Condition Jump	○	△	△	×	×	△	×	×	* <sup>4</sup>	×	×
	20: Interpolation Operation (Relative Address Specification)* <sup>2</sup>	×	×	×	×	×	×	×	×	×	×	×
22: Interpolation Operation (Absolute Address Specification)* <sup>2</sup>	×	×	×	×	×	×	×	×	×	×	×	

○: Can be used.

—: Cannot be used because operation ends after executing forward table.

×: Cannot be used.

△: Condition jump can be used depending on the forward table.

\*<sup>1</sup> Only CPU module is supported.

\*<sup>2</sup> Only FX5S/FX5U/FX5UC CPU module and high-speed pulse input/output module support interpolation operation.

\*<sup>3</sup> Can be used when control method [3: Interrupt 1 Speed Positioning] is specified as the second table.

\*<sup>4</sup> Can be used up to three times consecutively.

## Non-execution tables

Tables with positioning address setting such that no positioning is required are not executed and operation skips to the next table during continuous operation. The following table lists table non-execution conditions.

Control method	Table non-execution conditions
1: 1 Speed Positioning (Relative Address Specification)	Positioning address = 0
2: 1 Speed Positioning (Absolute Address Specification)	Positioning address = Current address when corresponding table is started* <sup>1</sup>
6: Interrupt Stop (Relative Address Specification)	Positioning address = 0
7: Interrupt Stop (Absolute Address Specification)	Positioning address = Current address when corresponding table is started* <sup>1</sup>

\*<sup>1</sup> The tables will be non-execution if specified as follows:

Table No.1: The positioning address of control method [1: 1 Speed Positioning (Relative Address Specification)] is 2000.

Table No.2: The positioning address of control method [2: 1 Speed Positioning (Absolute Address Specification)] is 2000.

## Precautions

The table execution ends with an error if 4 or more consecutive tables are non-execution.

# 34 PROGRAMMING

This chapter describes common items and precautions related to programs.

## 34.1 Table Operation Instruction

After setting table data, create a program that uses the table. (☞ Page 487 TABLE OPERATION)

Specify the table No., in the operand of the table operation instruction.

The following table shows operands specified for each table operation instruction.

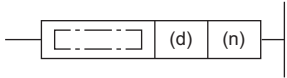
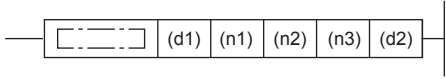
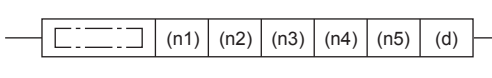
Instruction	Operand	Ladder	Reference
TBL*1	(n): Table number to be executed		Page 459
DRVTBL	(n1): First table number to be executed (n2): Last table number to be executed		Page 468
DRVMUL	(n2): Table number of the axis 1 (n3): Table number of the axis 2 (n4): Table number of the axis 3 (n5): Table number of the axis 4		Page 476

\*1 Only CPU module is supported.

## 34.2 Cautions for Program Creation

The following describes cautions for program creation.

### User interrupt program

Only CPU module\*1 can be executed in an interrupt program. If the high-speed pulse input/output module (axis 5 to axis 12) is executed in an interrupt program, an error occurs.

\*1 FX5S/FX5U/FX5UC CPU module: Axis 1 to Axis 4  
FX5UJ CPU module: Axis 1 to Axis 3

### Interrupt input signal 1

If the standard mode is used for interrupt signal input 1 for the high-speed pulse input/output module, approximately 2ms variance occurs before the start of the operation after the detection of interrupt input signal 1, so there is variance in travel distance after the detection of the interrupt input (changes depending on the interrupt request module). If this variance is not acceptable, use the high-speed mode or the CPU module.

### Positioning instructions in the same axis

- Do not activate multiple positioning instructions in the same axis. Another positioning instruction for the same axis cannot be driven until the pulses for the currently driven positioning operation are stopped and its drive contact is turned off.
- When the pulse output monitor is on, a positioning instruction that uses the corresponding axis cannot be used. (☞ Page 398 Pulse output monitor) While the pulse output monitor is on, even if the instruction drive contact is turned off, do not execute a positioning instruction that specifies the same axis number.

### Number of programmed positioning instructions

There is no limitation on the number of programmed positioning instructions. Programming one instruction two or more times does not cause any problems.

## External start signal

When the external start signal is enabled and off, a positioning instruction that uses the corresponding axis cannot be used. (☞ Page 383 External Start Signal) To use such a positioning instruction, turn on the drive contact of the instruction and then turn on the external start signal.

## Positioning instruction activation timing

### ■When the absolute position detection system is used

For the axis in which the absolute position detection system is used, activate the DABS instruction when the servo amplifier is powered on. (☞ Page 483 Absolute Position Detection System) After the ABS data has been read, the servo-ON (SON is on) status is retained, and it is disengaged when the DABS instruction is turned off. Activate the other instructions after the DABS instruction has read the ABS data.

### ■When the pulse output monitor is on

If the pulse output monitor is on, a positioning instruction (excluding the DABS instruction) that uses the same axis cannot be executed. (☞ Page 398 Pulse output monitor)

While a pulse output monitor is on even after the positioning instruction drive contact is set to off, a positioning instruction for the same output axis cannot be executed. Before re-executing a pulse output or positioning instruction, wait until the pulse output monitor turns off and one or more operation cycles pass.

### ■When a user interrupt is used

Driving a positioning instruction requires multiple scans and has both rising processing and falling processing. Thus, positioning does not operate normally if the positioning instruction is skipped by CJ instruction or if it is not executed every scan like inside an interrupt program. However, pulse output continues. Eliminating the instruction by online change also prevents the positioning from operating normally, and pulse output is stopped.

If the instruction is skipped, the complete flag does not turn on after the positioning operation stops. The complete flag turns on if the positioning instruction is executed again when CJ instruction is canceled or the user interrupt program is executed again. When the instruction is skipped, if disable all outputs (SM8034), pulse stop command, pulse decelerate and stop command, or limit in the movement direction is detected during a scan in which the positioning instruction is not executed, the positioning operation stops. The user-specified complete flag turns on, but the FX3 compatible complete flag (SM8029) does not turn on.

## Functions that share inputs and outputs

The inputs and outputs specified with the positioning parameter cannot be simultaneously used with another high-speed input/output function depending on the combination. (Page 232 HIGH-SPEED INPUT/OUTPUT FUNCTION)

### ■CPU module

#### • Input

The following functions occupy inputs of the high-speed input/output function.

Function		Up to CH/axis		Device	Simultaneous useable function
		FX5S/FX5U/ FX5UC	FX5UJ		
Input interrupt*1	Interrupt (Rising)	8 CH		X0 to X17	The functions other than high-speed counter (input A phase, input B phase)
	Interrupt (Falling)				
	Interrupt (Rising + Falling)				
	Interrupt (Rising) + Pulse Catch				
High-speed counter	A phase input	8 CH*2		X0 to X17	—
	B phase input				
	External preset input				
	External enable input				
Pulse width measurement		4 CH		X0 to X7	Input interrupt
Positioning	Near-point dog signal	4 axes	3 axes	X0 to X17	• Input interrupt • Zero signal
	Zero signal	4 axes	3 axes	X0 to X17	• Input interrupt • Near-point dog signal
	Interrupt input signal 1	4 axes	3 axes	X0 to X17	Input interrupt
	External start signal	4 axes	3 axes	X0 to X17	Input interrupt

\*1 If used simultaneously with another function, the input logic of the other function is applied.

\*2 When external preset input and external enable input are used, the number of usable channels is decreased depending on the counter type.

#### • Output

The following functions occupy outputs of the high-speed input/output function. The following functions cannot be combined with other high-speed input/output functions.

Function		Up to CH/axis		Device	
		FX5S/FX5U/FX5UC	FX5UJ	FX5S/FX5U/FX5UC	FX5UJ
PWM*1		4 CH		Y0 to Y7	
Positioning	PULSE	4 axes	3 axes	Y0 to Y3	Y0 to Y2
	SIGN			Y0 to Y17	
	CW	2 axis	—	Y0, Y1	—
	CCW			Y2, Y3	
	Clear signal	4 axes	3 axes	Y0 to Y17	

\*1 When positioning is not used, the output devices (Y) for which the positioning setting is enabled with parameters can be used as PWM outputs or general-purpose devices having no parameter.

## Precautions

Do not specify an output device (Y) used by the high-speed input/output function as the output destination of the high-speed comparison table.



## High-speed pulse input/output module

### Input

The following functions occupy inputs of the high-speed input/output function. The channels and the axis numbers are in module internal order.

Device*1	Input interrupt*2	High-speed counter	Pulse width measurement	Positioning
X□	X□	CH1 Input A phase	—	—
X□+1	X□+1	CH1 Input B phase/external preset	—	—
X□+2	X□+2	CH1 Input external preset	—	Axis2 Zero signal
X□+3	X□+3	CH2 Input A phase	CH1	Axis2 Interrupt input signal 1
X□+4	X□+4	CH2 Input B phase/external preset	CH2	Axis1 Interrupt input signal 1
X□+5	X□+5	CH2 Input external preset	—	Axis1 Zero signal
X□+6	X□+6	CH1 Input external enable	—	Axis2 External start signal
X□+7	X□+7	CH2 Input external enable	—	Axis1 External start signal

\*1 The number in □ is the head input number for each high-speed pulse input/output module.

\*2 Simultaneous use with a function other than the high-speed counter (A phase/B phase input) is possible. However, using with the channel 2 external enable input of the high-speed counter is not possible. However, the input logic of other functions is applied.

### Output

The following functions occupy outputs of the high-speed input/output function. The channels and the axis numbers are in module internal order. The following functions cannot be combined with other high-speed input/output functions.

Device*1	PWM	Positioning
Y□	—	Axis1 PULSE/CW
Y□+1	CH1	Axis2 PULSE/CW
Y□+2	—	Axis1 Clear signal
Y□+3	—	Axis2 Clear signal
Y□+4	—	Axis1 SIGN/CCW
Y□+5	CH2	Axis2 SIGN/CCW
Y□+6	—	—
Y□+7	—	—

\*1 The number in □ is the head output number for each high-speed pulse input/output module.

## Precautions

Do not specify an output device (Y) used by the high-speed input/output function as the output destination of the high-speed comparison table.

## Restrictions on simultaneous execution of the high-speed comparison table and high-speed comparison instructions

There is a limit in the number of simultaneous executions of the high-speed comparison table and high-speed comparison instructions (DHSCS, DHSCR, DHSZ instruction). Shown below are the conditions included in the number of the simultaneous executions. For high-speed comparison table, refer to the following.

☞ Page 254 High-speed comparison table

For high-speed comparison instructions and HIOEN/DHIOEN instruction, refer to MELSEC iQ-F FX5 Programming Manual (Instructions, Standard Functions/Function Blocks).

Item	CPU module	High-speed pulse input/output module
Maximum executions	32	15
High-speed counter function	<ul style="list-style-type: none"> <li>Drive high-speed comparison table (Drive HIOEN/DHIOEN instruction)</li> <li>Drive DHSCS, DHSCR, DHSZ instruction)</li> </ul>	<ul style="list-style-type: none"> <li>Drive high-speed comparison table (Drive HIOEN/DHIOEN instruction)</li> </ul>
Positioning function	<ul style="list-style-type: none"> <li>Interrupt input signal 1 (High-speed mode) setting is enabled</li> </ul>	<ul style="list-style-type: none"> <li>OPR setting is enabled (1 axis occupies 2 simultaneous executions.)</li> <li>Interrupt input signal 1 (High-speed mode) setting is enabled</li> </ul>

- For the high-speed comparison table, only the tables driven by the HIOEN/DHIOEN instruction are included in the number of the simultaneous executions.
- When the positioning function setting is made, high-speed comparison table becomes occupied and is included in the number of simultaneous executions.

## Correction of backlash

The positioning function cannot correct mechanical backlash (clearance/play). If it is necessary to correct the backlash, set the number of output pulses taking into account the backlash that may be caused when reversing the transfer direction beforehand.

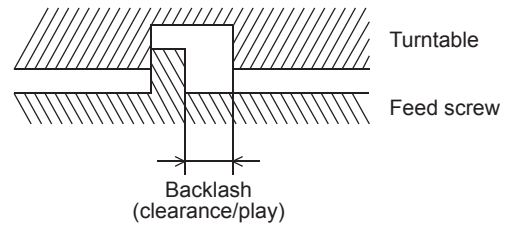

## Complete flag and completion of positioning operation

If the complete flag of a positioning instruction is turned on, then the execution of the instruction (such as pulse outputting operation) is complete (☞ Page 400 Complete flag). However, it is not certain whether the servo motor has stopped or not. Check the "positioning completion" signal of the servo amplifier (drive unit) to determine whether the servo motor has stopped.

## Online change

Do not perform online change if a positioning instruction is being executed (pulses are being output). Operations if online change is performed while the instruction is executed are described in the following table. Also do not perform online change if PWM is being executed. For details on the PWM/DPWM instructions, refer to  MELSEC iQ-F FX5 Programming Manual (Instructions, Standard Functions/Function Blocks).

Positioning instruction			PLC operation when online change is performed while instruction is executed	Reference
Pulse Y output instruction*1	PLSY/DPLSY		Immediately stops pulse output.	Page 405
Mechanical OPR instruction	DSZR/DDSZR		Decelerates and stops pulse output.	Page 411
Relative positioning instruction	DRV/DDRVI			Page 421
Absolute positioning instruction	DRVA/DDRVA			Page 431
Interrupt 1-speed positioning instruction	DVIT/DDVIT			Page 440
Variable speed operation instruction	PLSV/DPLSV	With acceleration/ deceleration operation	Decelerates and stops pulse output.	Page 450
		Without acceleration/ deceleration operation	Immediately stops pulse output.	
Single-table operation instruction*1	TBL		Online change cannot be performed.	Page 459
Multiple-table operation instruction	DRVTBL			Page 468
Multiple-axis table operation instruction	DRVMUL			Page 476

\*1 Only CPU module is supported.

## Precautions

Note that immediate stop may damage the machine because the motor stops immediately.

# 34.3 Program Example

This program example shows the operation that controls the one-axis MELSERVO series amplifier. Positioning is performed in the absolute position method by the OPR and forward/reverse rotation positioning as shown below. (Any JOG operation can be set.)

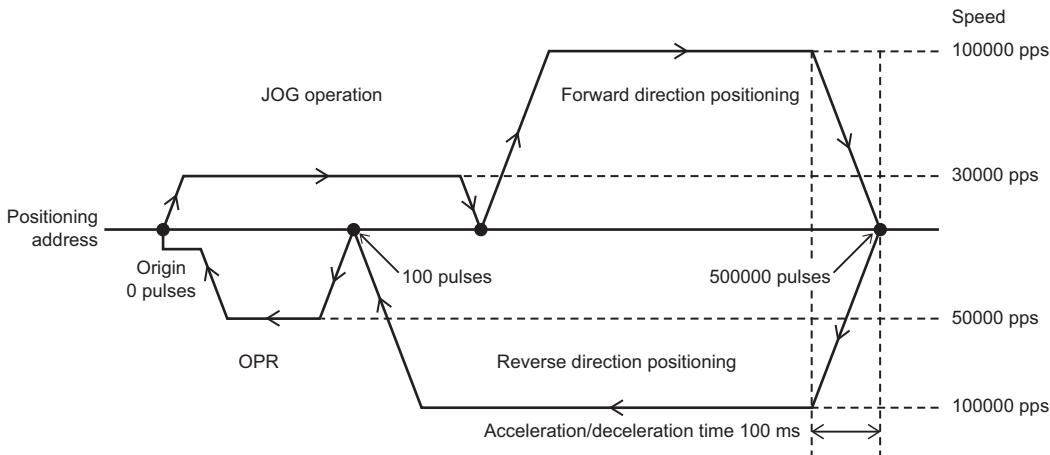

## Operation chart

Details for each positioning operation chart are shown below.

### ■OPR

When X21 is turned on, the positioning is started for the origin (0 pulse).

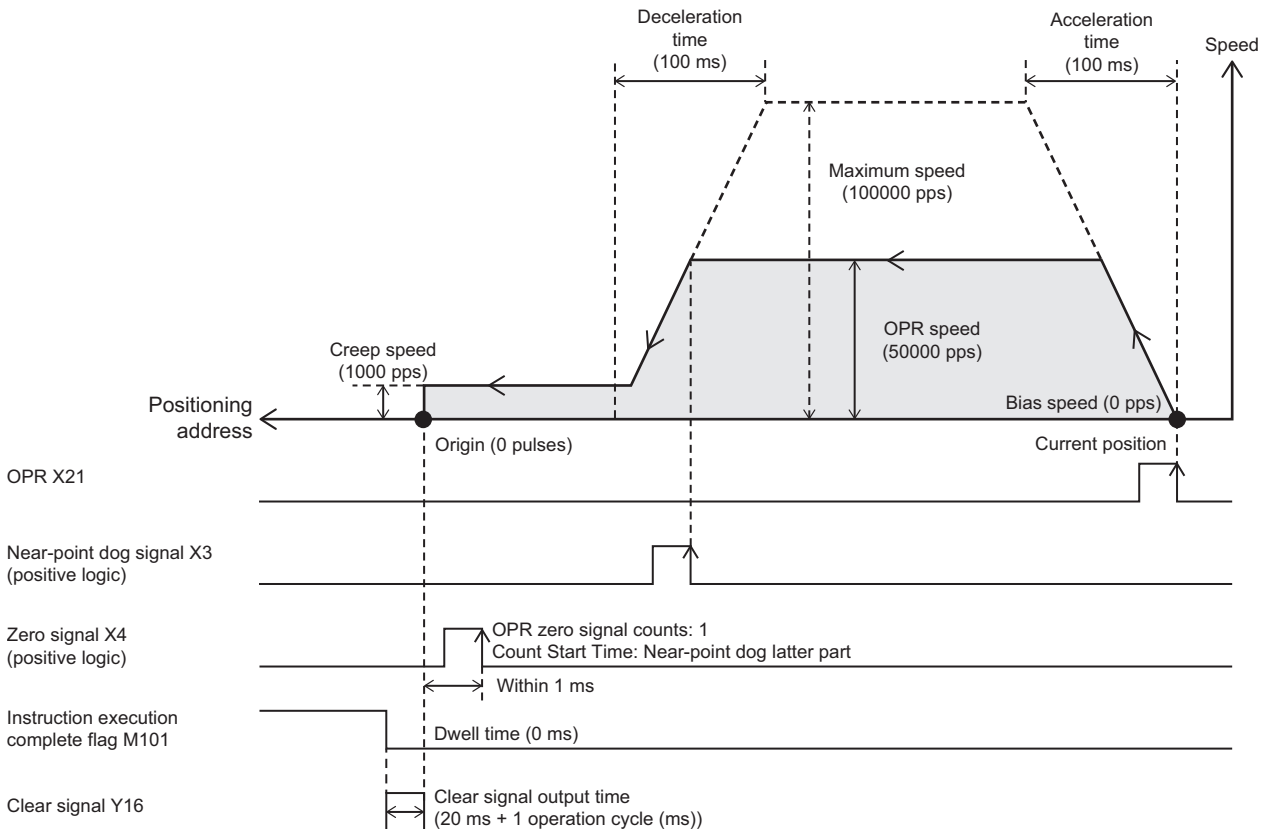

## ■JOG operation

When X22 is turned on, the JOG operation is started in the forward direction. When X23 is turned on, the JOG operation is started in the reverse direction. When X22 or X23 is turned off from on, the JOG operation decelerates and stops.

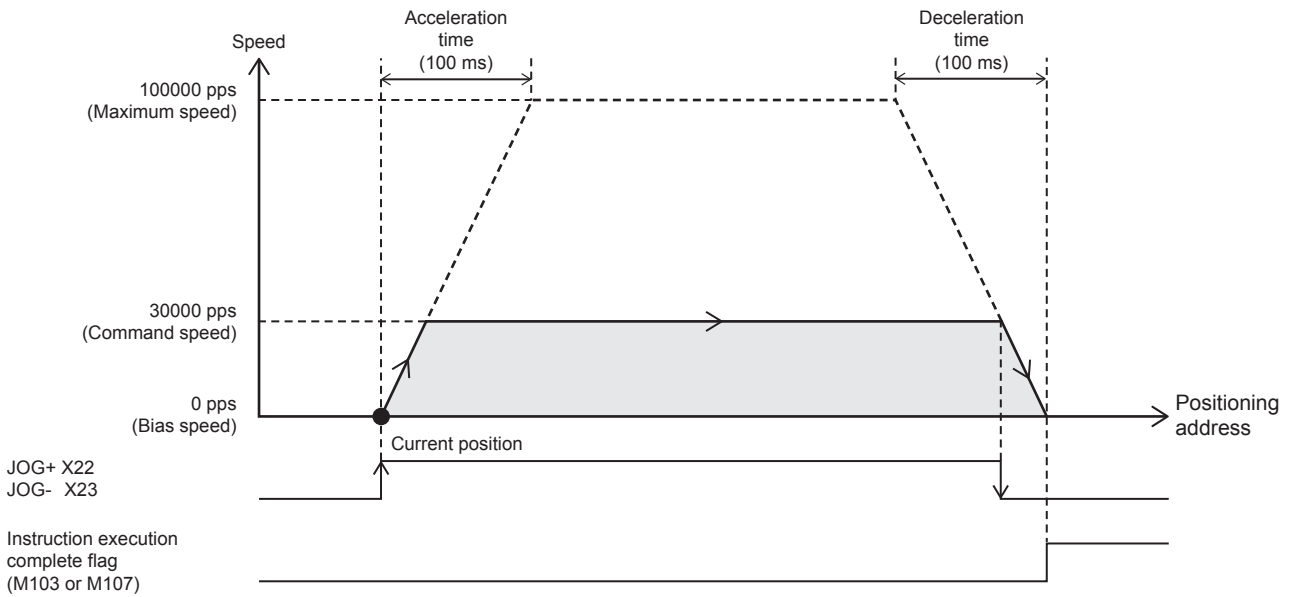

## ■Forward direction positioning

When X24 is turned on, the positioning is started for the target position (500000 pulses). If current address is 500001 pulses or more, positioning operation output in the reverse direction.

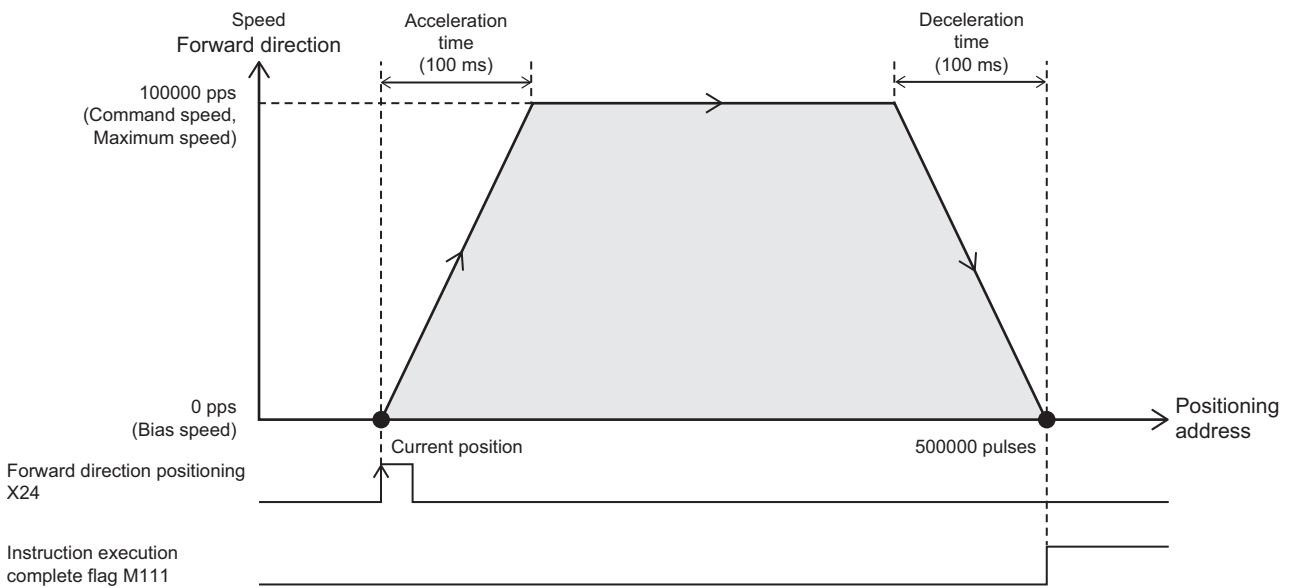

### Reverse direction positioning

When X25 is turned on, the positioning is started for the target position (100 pulses). If current address is less than 100 pulses, positioning operation output in the forward direction.

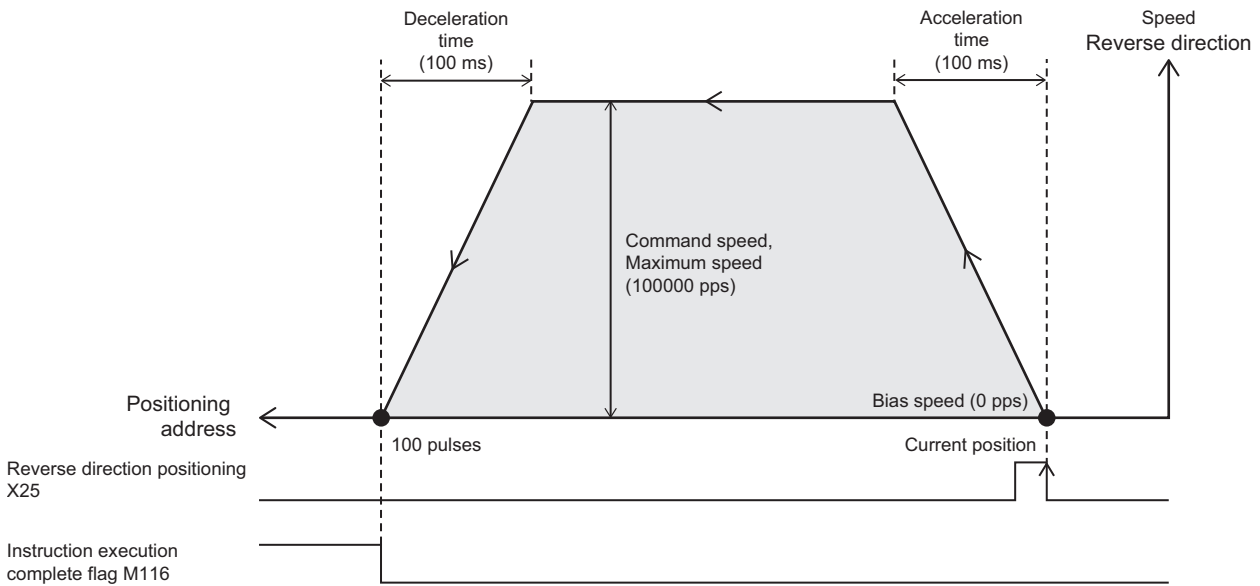

## Input/output assignment

The input/output assignment is as follows. (Page 341 Input assignment, Page 346 Assignment of output numbers)

For example connection of MELSERVO series servo amplifier, refer to Page 939 Connection Example of Servo Amplifier.

### Input assignment

Input number	Signal name	Connection destination
X3	Near-point signal	Sensor, limit switch
X4	Zero signal	Servo amplifier
X10	Pulse stop command input	External switch
X11	Pulse decelerate and stop command input	
X12	Forward limit input	Sensor, limit switch
X13	Reverse limit input	
X15	Servo ready	Servo amplifier
X21	OPR	External switch
X22	JOG+	
X23	JOG-	
X24	Forward direction positioning	
X25	Reverse direction positioning	

### Output assignment

Output number	Signal name	Connection destination
Y0	Pulse train (Pulse output destination)	Servo amplifier
Y4	Direction (Rotation direction signal)	
Y16	Clear signal	

# Parameter setting

The setting values of the positioning parameters are shown below. (Page 365 Basic setting)

## Setting data

Item	Axis 1	Item	Axis 1
■Basic Parameter 1		■Detailed Setting Parameter	
Pulse Output Mode	1: PULSE/SIGN	External Start Signal Enabled/ Disabled	0: Disabled
Output Device (PULSE/CW)	Y0	Interrupt Input Signal 1 Enabled/ Disabled	0: Disabled
Output Device (SIGN/CCW)	Y4	Interrupt Input Signal 2 Logic	0: Positive Logic
Rotation Direction Setting	0: Current Address Increment with Forward Run Pulse Output	■OPR Parameter	
Unit Setting	0: Motor System (pulse, pps)	OPR Enabled/Disabled	1: Enabled
No. of Pulse per Rotation	2000 pulses	OPR Direction	0: Negative Direction (Address Decrement Direction)
Movement Amount per Rotation	1000 pulses	Starting Point Address	0 pulse
Position Data Magnification	1: × Single	Clear Signal Output Enabled/ Disabled	1: Enabled
■Basic Parameter 2		Clear Signal Output Device No.	Y16
Interpolation Speed Specified Method	0: Composite Speed	OPR Dwell Time	0 ms
Max. Speed	100000 pps	Near-point Dog Signal Device No.	X3
Bias Speed	0 pps	Near-point Dog Signal Logic	0: Positive Logic
Acceleration Time	100 ms	Zero Signal Device No.	X4
Deceleration Time	100 ms	Zero Signal Logic	0: Positive Logic
—		Zero Signal OPR Zero Signal Counts	1
		Zero Signal Count Start Time	0: Near-point Dog Latter Part

# Forward/reverse rotation program

The positioning instructions used in the program examples are shown below.

Positioning instruction		Reference
Mechanical OPR	DSZR/DDSZR	Page 411
Absolute positioning	DRVA/DDRVA	Page 431
Variable speed operation	PLSV/DPLSV	Page 450

## Program example

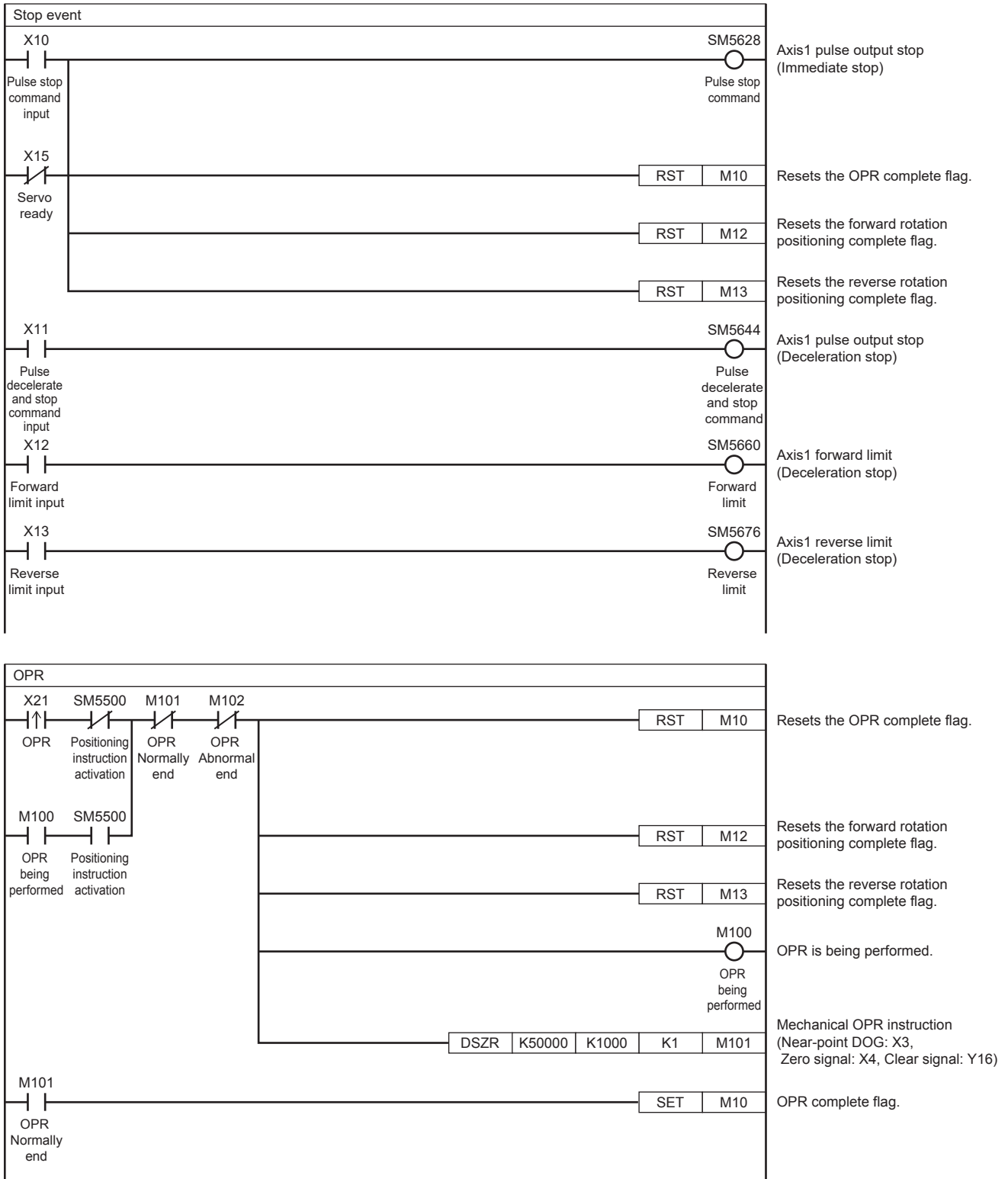

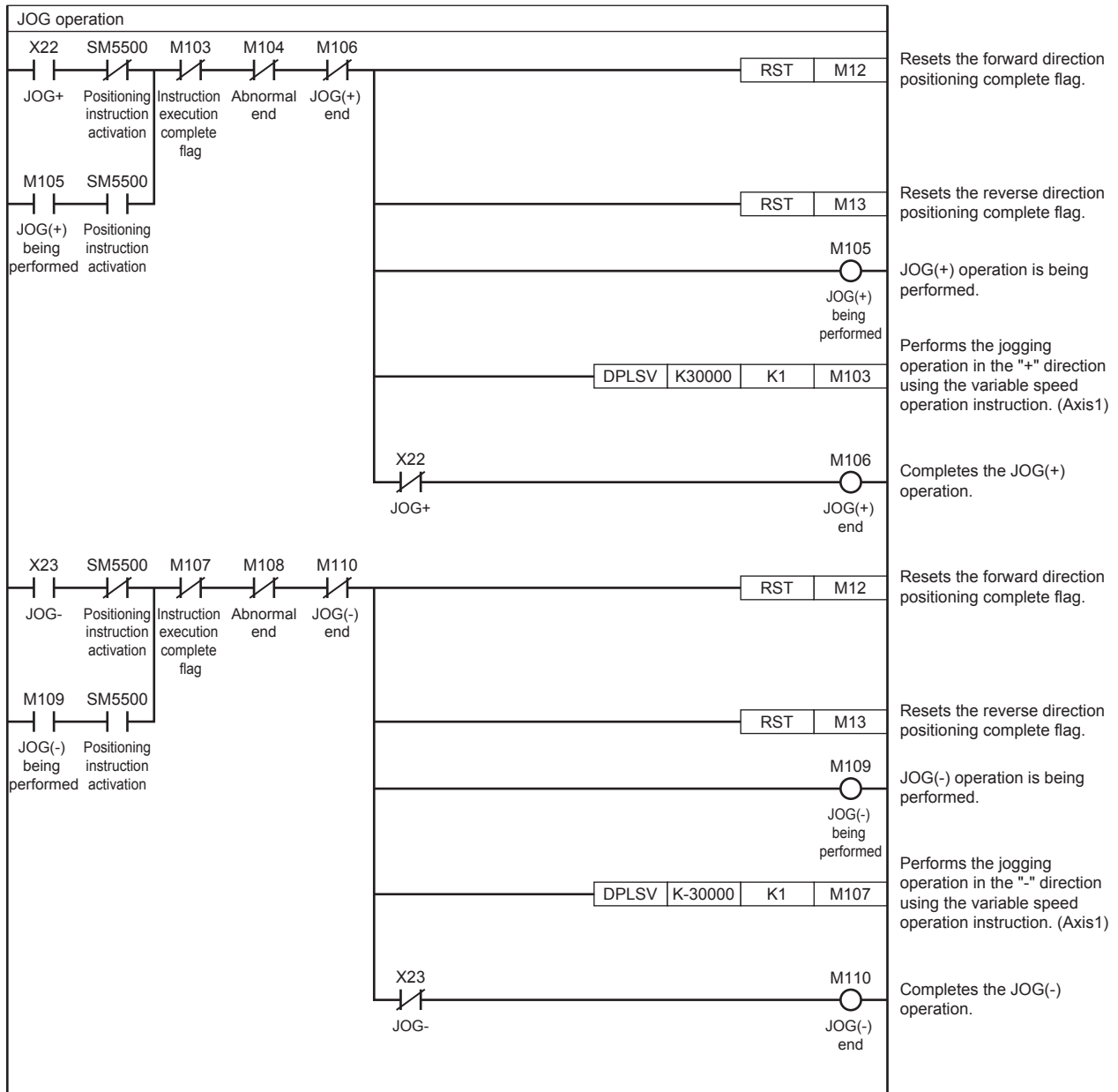



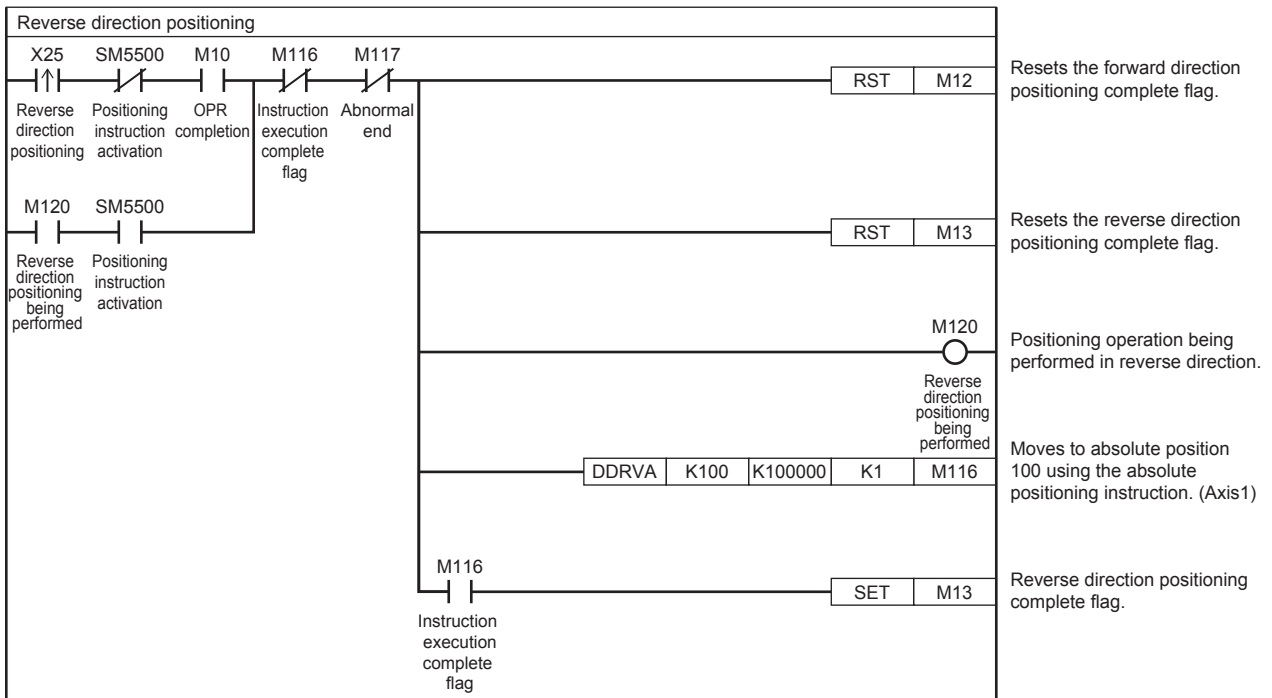
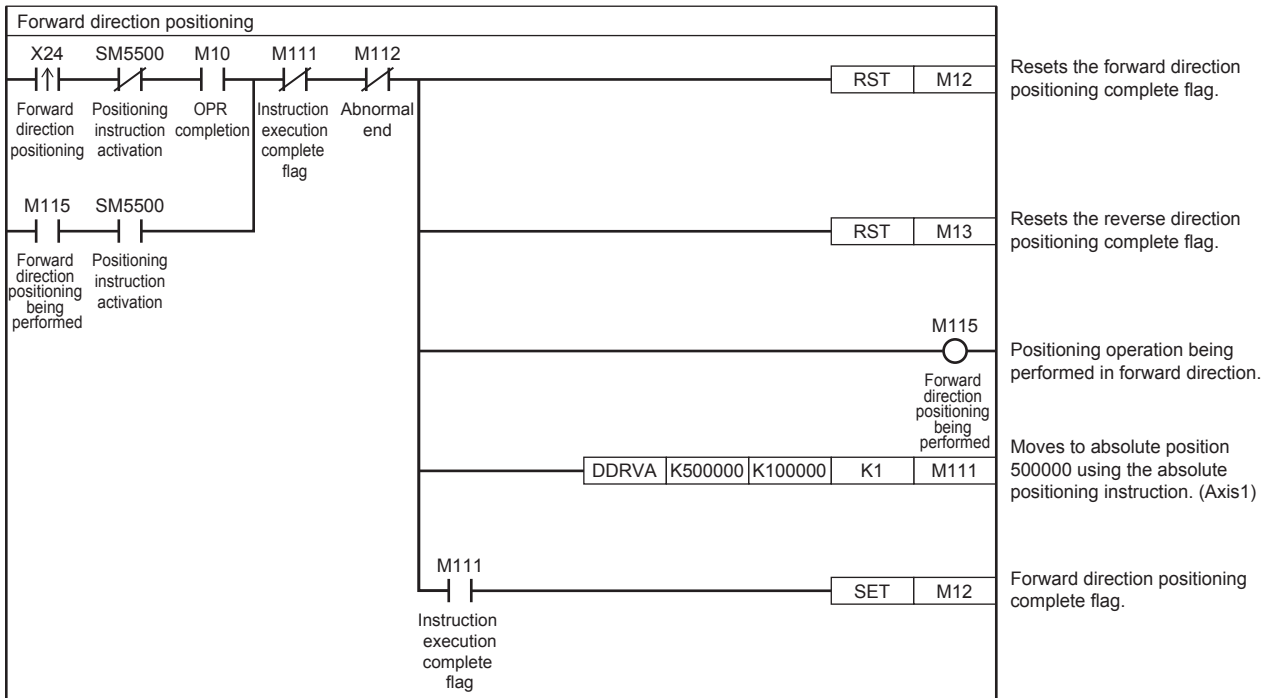

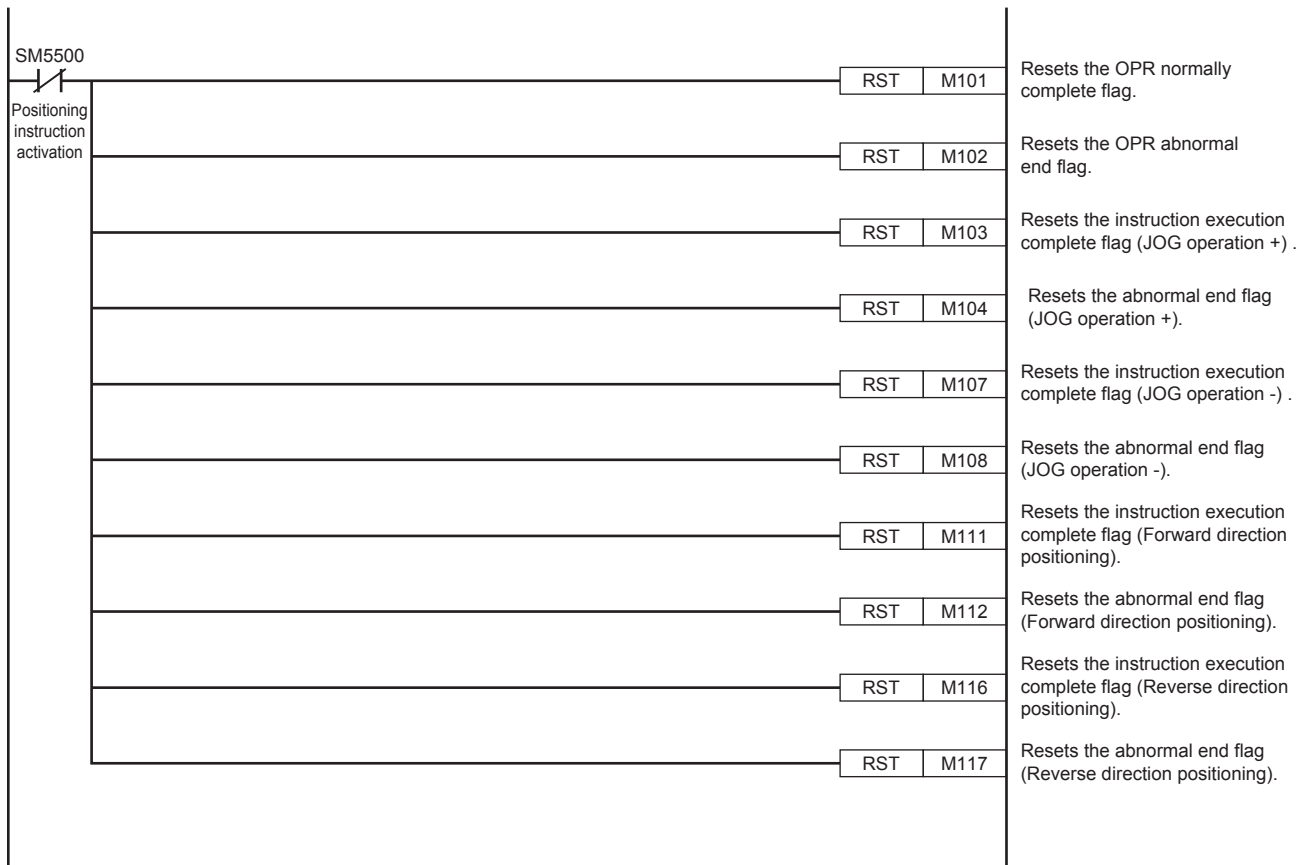

## 34.4 FX3 Compatible SM/SD

FX3 compatible devices can be used. Devices other than the instruction execution complete flag (SM8029) and the instruction execution abnormal end flag (SM8329) are supported for only CPU module.

Both the FX5 dedicated devices and FX3 compatible devices can be used if they have the same functionality.

For details on devices, refer to  Page 370 Details of Parameters.

# 35 TROUBLESHOOTING

This chapter describes the errors and problems related to the positioning function.

## 35.1 LED Status During Pulse Output and Rotation Direction Output

Check the on/off status of LED indicator lamp on the CPU module that indicates the status of the output device (Y) to assess the positioning operation status. For other LEDs, refer to the following manuals.

📖 MELSEC iQ-F FX5S/FX5UJ/FX5U/FX5UC User's Manual (Hardware)

Signal		CPU module				High-speed I/O positioning <sup>*2</sup>		LED status during execution of positioning instruction	Description
		Axis 1	Axis 2	Axis 3	Axis 4 <sup>*1</sup>	Axis ■	Axis ■+1		
Pulse output destination	PULSE (pulse train)	Y0	Y1	Y2	Y3	Y□	Y□+1	Flashing (turned on and off at high speed)	The pulse output operation is controlled by the positioning instruction.
								OFF	One of the following has occurred: 1) The operation of the positioning instruction is completed. 2) An error occurred during positioning. The instruction, therefore, is not being executed.
	CW <sup>*1</sup> (forward pulse train)	Y0	Y1	—	—	Y□	Y□+1	Flashing (turned on and off at high speed)	Forward operation is being executed for a positioning instruction. Reverse pulse train is off.
								OFF	One of the following has occurred: 1) The operation of the positioning instruction is completed. 2) An error occurred during positioning. The instruction, therefore, is not being executed.
Rotation direction output	SIGN (direction)	Y0 to Y17				Y□+4	Y□+5	ON	Forward operation is in execution.
								OFF	One of the following has occurred: 1) The positioning instruction turns on, and operation is being performed in the reverse rotation direction. 2) An error occurred during positioning. The instruction, therefore, is not being executed.
	CCW <sup>*1</sup> (reverse rotation pulse train)	Y2	Y3	—	—	Y□+4	Y□+5	Flashing (turned on and off at high speed)	Reverse operation is being executed for a positioning instruction. Forward pulse train is off.
								OFF	One of the following has occurred: 1) The operation of the positioning instruction is completed. 2) An error occurred during positioning. The instruction, therefore, is not being executed.

\*1 Only FX5S/FX5U/FX5UC CPU module is supported.

\*2 The number in ■ is first module: 5, second module: 7, third module: 9, fourth module: 11.

The number in □ is the head output number for each high-speed pulse input/output module.

## 35.2 Servo Motor, Stepping Motor

---

If the servo motor or the stepping motor does not operate, check the following items.

**1.** Check the wiring.

For the output specifications, refer to [Page 343 Output Specifications](#).

For details on the MELSERVO series servo amplifier (drive unit), refer to the manuals for the unit used.

- 2.** Execute the positioning instruction, and then check the statuses of the following LED indicator lamps. ([Page 537 LED Status During Pulse Output and Rotation Direction Output](#))
- LED indicator lamp of the output specified as the pulse output destination device
  - LED indicator lamp of the output specified as the rotation direction output device
- 3.** Verify that the same pulse output method is being applied for both the PLC and the servo amplifier (drive unit). ([Page 370 Pulse Output Mode](#))
- 4.** Check that the flag which stops the pulse is off. ([Page 404 Pulse output stop](#))
- 5.** Check the operation timing of the positioning instruction. ([Page 525 Positioning instruction activation timing](#))

## 35.3 Stop Position

If operation is stopped at the wrong position, check the following items.

1. Check whether the electronic gear of the servo amplifier (drive unit) is set properly. (☞ Page 373 Unit Setting)
2. Check whether the origin is set properly.
  - Properly set the near-point dog so that the near-point dog signal can be kept in the ON status until the speed is reduced to the creep speed. (☞ Page 390 Near-point Dog Signal, Page 389 Creep speed) The DSZR/DDSZR instruction starts deceleration to the creep speed at the front end of the near-point dog, the operation stops at "the rear end of the near-point dog" or at "detection of the first zero signal after the rear end of the near-point dog", and the current address is cleared. (☞ Page 411 Mechanical OPR)
  - The creep speed should be sufficiently slow. The DSZR/DDSZR instruction will not reduce the speed before stopping. For this reason, if the creep speed is not slow enough, the operation may not be stopped at the specified position due to inertia.
  - Detection of (the rear end and the front end of) the near-point dog signal will be affected by the response time and the scan time of the sequence program. Ensure 1 scan time or more from the rear end of the dog to turning on of the zero signal.
  - When the DSZR/DDSZR instruction is used, the zero signal of the servo motor is used. Adjust the relation between the rear end of the near-point dog and the zero signal as shown in the following figure. If fine adjustment of the origin position is needed, adjust the position of the near-point dog.

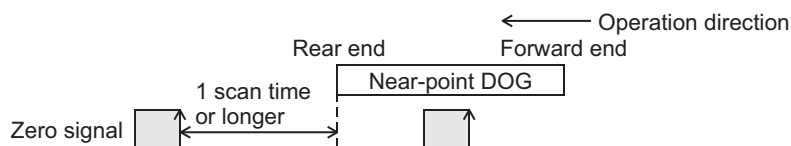

3. If reciprocating operation (operation in the forward rotation direction and then reverse rotation direction) is not stopped at the specified position:

The positioning function cannot correct mechanical backlash (clearance/play). If it is necessary to correct the backlash or reverse the transfer direction, set the number of output pulses taking into account the backlash that may be caused beforehand.

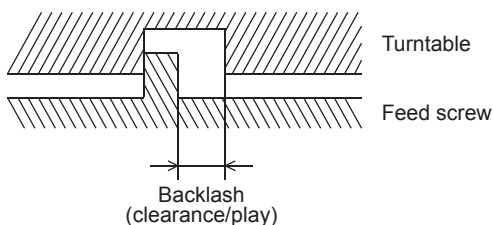

# MEMO

---

This part consists of the following chapters.

36 CPU MODULE BUILT-IN ANALOG FUNCTION

---

37 ANALOG ADAPTERS

---

# 36 CPU MODULE BUILT-IN ANALOG FUNCTION

This chapter describes the built into analog the FX5U CPU module.

The FX5U CPU module has 2 points of built-in analog voltage input and 1 point of built-in analog voltage output.

Values A/D-converted by the FX5U CPU module are written to special registers assigned to each channel. D/A-converted analog data are output when values are set to special registers in the FX5U CPU module.

## 36.1 Specifications

This section describes the specifications.

### Generic specifications

For the general specification, refer to the following manual.

📖 MELSEC iQ-F FX5S/FX5UJ/FX5U/FX5UC User's Manual (Hardware)

### Performance specifications

This section describes the performance specifications.

#### Analog input

Item		Specifications
No. of analog input points		2 points (2 channels)
Analog input	Voltage	0 to 10 V DC (input resistance 115.7 kΩ)
Digital output		Unsigned 12-bit binary
Device allocation		SD6020 (A/D-converted input data of ch1) SD6060 (A/D-converted input data of ch2)
Input characteristics, max. resolution	Digital output value	0 to 4000
	Max. resolution	2.5 mV
Accuracy (Accuracy for the full scale of the digital output value)	Ambient temperature 25±5°C	Within ±0.5% (±20 digit <sup>*2</sup> )
	Ambient temperature 0 to 55°C	Within ±1.0% (±40 digit <sup>*2</sup> )
	Ambient temperature -20 to 0°C <sup>*1</sup>	Within ±1.5% (±60 digit <sup>*2</sup> )
Conversion speed		30 μs/channel (data refreshed every operation cycle)
Absolute max. input		-0.5 V, +15 V
Insulation method		Inside the CPU module and the analog input circuit are not insulated. Between input terminals (channels) is not insulated.
No. of occupied input/output points		0 point (does not pertain to the max. No. of input/output points of the CPU module.)

\*1 This specification does not apply to products manufactured before June 2016.

\*2 "digit" refers to digital values.



## Analog output

Item		Specifications
No. of analog output points		1 point (1 channel)
Digital input		Unsigned 12-bit binary
Analog output	Voltage	0 to 10 V DC (external load resistance 2 k to 1 M $\Omega$ )
Device allocation		SD6180 (Output setting data)
Output characteristics, max. resolution* <sup>1</sup>	Digital input value	0 to 4000
	Max. resolution	2.5 mV
Accuracy* <sup>2</sup> (Accuracy for the full scale analog output value)	Ambient temperature 25 $\pm$ 5 $^{\circ}$ C	Within $\pm$ 0.5% ( $\pm$ 20 digit* <sup>4</sup> )
	Ambient temperature 0 to 55 $^{\circ}$ C	Within $\pm$ 1.0% ( $\pm$ 40 digit* <sup>4</sup> )
	Ambient temperature -20 to 0 $^{\circ}$ C* <sup>3</sup>	Within $\pm$ 1.5% ( $\pm$ 60 digit* <sup>4</sup> )
Conversion speed		30 $\mu$ s (data refreshed every operation cycle)
Insulation method		Inside the CPU module and the analog output circuit are not insulated.
No. of occupied input/output points		0 point (does not pertain to the max. No. of input/output points of the CPU module.)

\*1 There is a dead band near 0 V output, which is an area where some digital input values are not reflected to analog output values.

\*2 External load resistance is set to 2 k $\Omega$  when shipped from the factory. Thus, output voltage will increase somewhat if the resistance is set higher than 2 k $\Omega$ . When the resistance is 1 M $\Omega$ , output voltage increases by a maximum of 2%.

\*3 This specification does not apply to products manufactured before June 2016.

\*4 "digit" refers to digital values.

# Accuracy

## Built-in analog input

Accuracy of A/D conversion is determined by the accuracy for the full scale of digital output value.

The accuracy is within  $\pm 0.5\%$  ( $\pm 20$  digits) at ambient temperature of  $25\pm 5^\circ\text{C}$ , within  $\pm 1.0\%$  ( $\pm 40$  digits) at ambient temperature of 0 to  $55^\circ\text{C}$ , and within  $\pm 1.5\%$  ( $\pm 60$  digits) at ambient temperature of  $-20$  to  $0^\circ\text{C}$ . (Except for the conditions under the influence of noise)

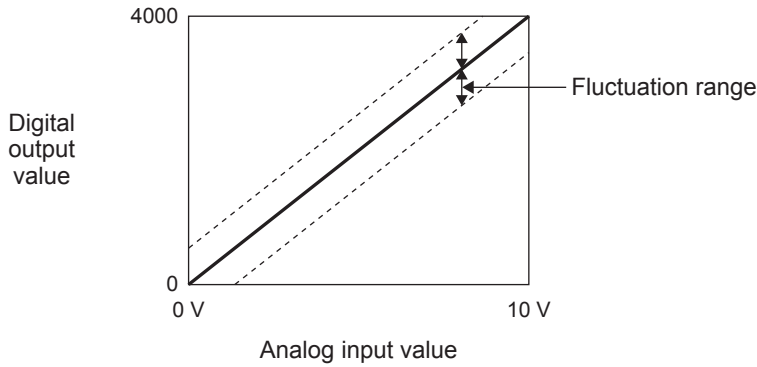

## Built-in analog output

Accuracy of D/A conversion is determined by the accuracy for the full scale of analog output value.

The accuracy is within  $\pm 0.5\%$  ( $\pm 20$  digits) at ambient temperature of  $25\pm 5^\circ\text{C}$ , within  $\pm 1.0\%$  ( $\pm 40$  digits) at ambient temperature of 0 to  $55^\circ\text{C}$ , and within  $\pm 1.5\%$  ( $\pm 60$  digits) at ambient temperature of  $-20$  to  $0^\circ\text{C}$ . (Except for the conditions under the influence of noise)

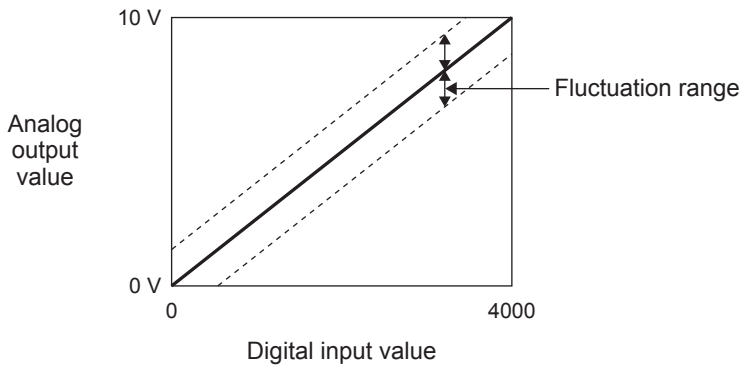

## 36.2 List of Functions

The following table lists the functions.

### Analog input

List of functions	Description	Reference
A/D conversion enable/disable setting function	Function to enable or disable A/D conversion per channel. The conversion process time can be reduced by disabling conversion for unused channels.	Page 547
A/D conversion method	Sampling processing	Method of converting each analog input at END processing to generate the equivalent digital output.
	Time average	Method of averaging the time of A/D conversion values and outputting these average values as the digital signal.
	Count average	Method of averaging the count of A/D conversion values and outputting these average values as the digital signal.
	Moving Average	Method of averaging the analog input for a specified count measured at every END process, and outputting these average values as the digital signal.
Over scale detection function	Function to detect analog input values that are over an input range.	Page 550
Scaling function	Function that converts user-defined maximum and minimum digital values in accordance with a configured scale.	Page 552
Shift function	Function that adds a specified amount to the A/D conversion value. Fine adjustments during system startup can be easily performed.	Page 553
Digital clipping function	Function that specifies the maximum A/D conversion value as 4000 and the minimum value as 0 when voltage is input that exceeds the input range.	Page 551
Maximum value/minimum value hold function	Function that holds the minimum and maximum digital operation values.	Page 554
Warning output function	Function to output warning when digital operation values exceed the specified range.	Page 555
Event history function	Collects errors that occurred in the CPU module, and stores them as event information into the CPU module.	Page 556

### Analog output

List of functions	Description	Reference
D/A conversion enable/disable function	Function to enable or disable D/A conversion. When analog output is not used, the conversion process time can be reduced by disabling conversion.	Page 558
D/A output enable/disable setting function	Specifies whether to output the D/A conversion value or output an offset value (HOLD setting value).	Page 558
Analog output HOLD/CLEAR function	Sets the digital value before D/A conversion to the previous value or clears the value (0) depending on the operation status of the CPU module (RUN, STOP, and STOP error).	Page 559
Analog output test when CPU module is in STOP status function	Outputs a user-defined analog value by setting the output enable/disable flag to enabled when the CPU module is stopped, and changing the digital value.	Page 560
Scaling function	Function that converts user-defined maximum and minimum digital values in accordance with a configured scale.	Page 561
Shift function	Function that adds a specified amount to the digital value. Fine adjustments during system startup can be easily performed.	Page 562
Warning output function	Function to output warning when digital values exceed the specified range.	Page 562
Event history function	Collects errors that occurred in the CPU module, and stores them as event information into the CPU module.	Page 564

### PID control function

List of functions	Description	Reference
PID control via instruction function	Performs PID control by the PID instruction.	Page 564
PID control via parameter function	Performs PID control (standard PID control, heating-cooling PID control) by using GX Works3 parameters.	Page 601

## 36.3 Functions (Analog Input)

This section describes the functions of the built into analog the FX5U CPU module and the setting procedures for those functions.

### Processing of each function

The functions are processed in the order shown below.

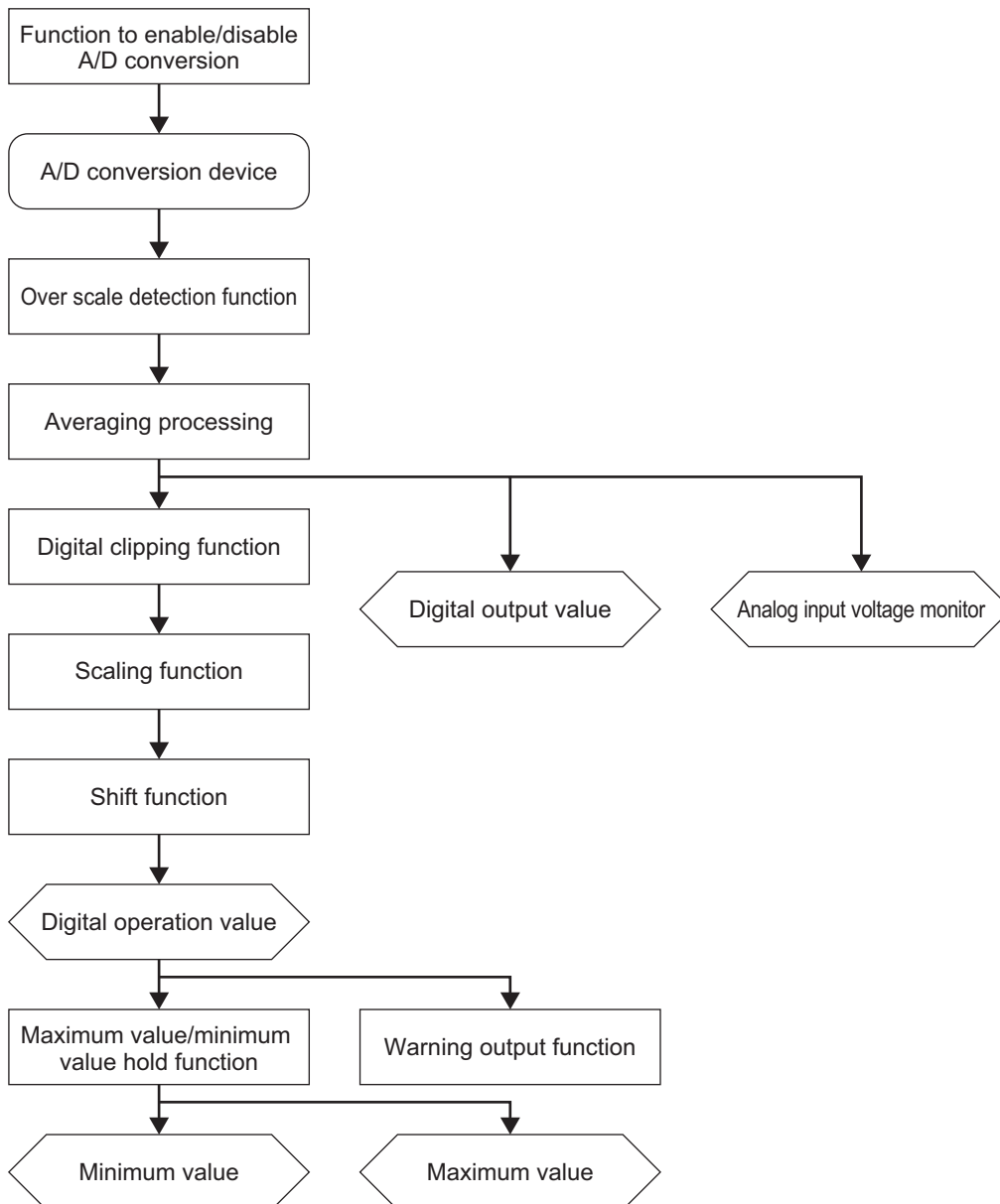

#### Digital output value

A digital value obtained by applying sampling processing or various types of averaging processing.

## Digital operation value

A value obtained by operating a digital output value using the digital clipping function, scaling function, or shift function. When any of the functions is not used, the same value as the digital output value is stored.

## Analog input voltage monitor

The input voltage value is displayed. Voltage is displayed in the following units.

Voltage: mV

## Maximum and minimum value

The maximum and minimum values of the digital operation values are stored.

## A/D conversion enable/disable setting function

This function controls whether to enable or disable the A/D conversion for each channel.

The conversion process time can be reduced by disabling conversion for unused channels.

## Corresponding devices

The devices which are used by the A/D conversion enable/disable setting function are listed below.

Name	CH1	CH2
A/D conversion enable/disable setting	SM6021	SM6061

## Setting methods

A/D conversion is enabled/disabled for each channel by the setting to enable/disable A/D conversion.

Name	Allowable setting range	Default value
A/D conversion enable/disable setting	0: Enable A/D conversion	1: Disable A/D conversion
	1: Disable A/D conversion	

### Point

Setting is enabled from the next END process that detected the change in the setting value. However, if there is a problem in the value set for the A/D conversion method, changing this setting from disabled to enabled will not result in an enabled status.

## Operation

The analog input is converted to a digital signal only for the channel(s) which have been enabled for A/D conversion by the setting to enable/disable A/D conversion.

### Point

While A/D conversion is disabled, the A/D conversion method setting can be changed.

# A/D conversion method

Specify the method of A/D conversion for each channel.

The following A/D conversion methods are available.

Method	Description
Sampling processing	Method of converting each analog input at END processing to generate the equivalent digital output.
Time average	Method of averaging the time of A/D conversion values and outputting these average values as the digital signal.
Count average	Method of averaging the count of A/D conversion values and outputting these average values as the digital signal.
Moving Average	Method of averaging the analog input for a specified count measured at every END process, and outputting these average values as the digital signal.

## Corresponding devices

The devices which are used by the A/D conversion method are listed below.

Name	CH1	CH2
Average processing specify	SD6023	SD6063
Time Average/Count Average/Moving Average setting	SD6024	SD6064

## Setting methods

The procedure to change the A/D conversion method is described below.

1. Disable A/D conversion.
2. Specify the averaging process setting.

Use the averaging process setting for each channel to change the A/D conversion method.

Name	Allowable setting range	Default value
Averaging process setting	0: Sampling processing	0: Sampling processing
	1: Time average	
	2: Count average	
	3: Moving average	

3. Specify Time Average/Count Average/Moving Average setting.

When the averaging process (1 to 3) is specified by the averaging process setting, set the Time Average/Count Average/Moving Average setting with the relevant setting for the appropriate channel.

Name	Allowable setting range	Default value
Time average	1 to 10000 (ms)	0
Count average	4 to 32767 (times)	
Moving Average	2 to 64 (times)	

4. Enable A/D conversion.

## Operation

This section describes the operation of each A/D conversion method.

### ■Sampling processing

The analog input is sequentially converted into a digital signal through A/D conversion by the END process to create the digital output, and the digital output values and digital operation values are stored.

### ■Time average

A/D conversion is executed for a set time, the total value is averaged, and the digital output values and digital operation values are stored.

The processing count during the specified time changes depending on the number of channels enabled for conversion.

Number of processing times = Setting time ÷ Scan time

#### Point

If the set time is shorter than the scan time, the averaging processing is not executed, but the sampling value is output. For the initial output, however, the average of the first and second sampling values is output.

### ■Count average

A/D conversion is executed for a set number of times, the averaged value is output as the digital signal, and the digital output values and digital operation values are stored.

The time required to store the averaged value obtained by count average in the digital output values and digital operation values varies depending on the scan time.

Processing time = Set number of times × Scan time

#### Point

Because the count average requires a sum of at least two counts excluding the maximum and minimum values, the set number of times should be four or more.

### ■Moving average

The number of moving average processing of A/D conversion values can be specified, the averaged value is output as the digital signal, and the digital output values and digital operation values are stored.

Because the averaging process with specified count is performed for the A/D conversion value while transitioning between each conversion cycle, the latest digital output values and digital operation values are obtained.

The following figure shows the moving average processing of when the set number of times is five.

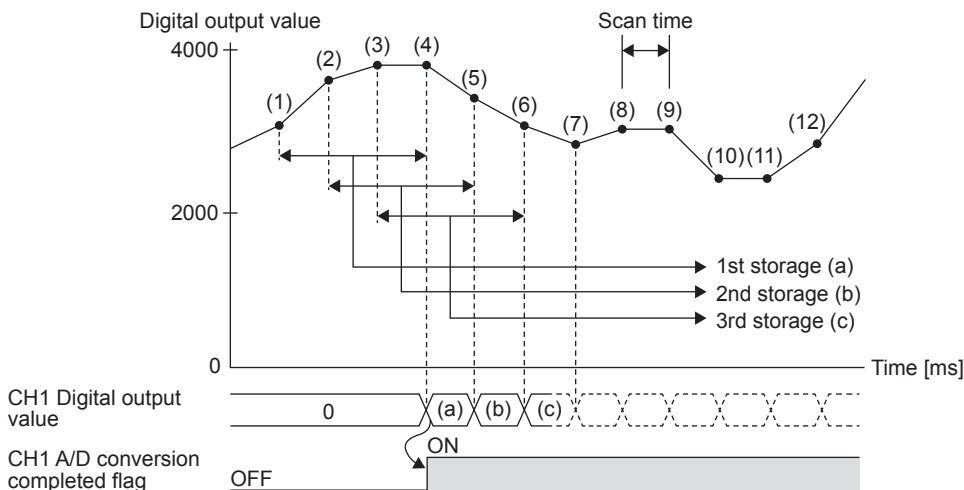

# Over scale detection function

Function to detect analog input values that are over an input range.

## Corresponding devices

The devices which are used by the over scale detection function are listed below.

Name	CH1	CH2
Over scale detection flag	SM6022	SM6062
Over scale detection enable/disable setting	SM6024	SM6064
A/D conversion alarm clear request	SM6057	SM6097
A/D conversion alarm flag	SM6058	SM6098
A/D conversion latest alarm code	SD6058	SD6098

## Setting methods

Enables/disables the over scale detection setting for each channel.

Name	Allowable setting range	Default value
Over scale detection enable/disable setting	0: Enabled	0: Enabled
	1: Disabled	



Setting is enabled from the next END process that detected the change in the setting value.

## Operation

Detected when the input analog voltage exceeds 10.2 V.

For the channel in which over-limit is detected, the digital output value before over-limit is stored, and the A/D conversion complete flag is turned off for this channel. Regardless of the over-limit detection flag reset, once the analog input value returns to 10.2 V, the A/D conversion complete flag will be turned on for this channel after the first update since the A/D conversion restart.

When using the averaging function, the averaging process is cleared at the time of the over-limit detection. The averaging process is restarted after over-limit is cleared.

### ■Detection cycle

This function is executed during the END process.

### ■Clearing the over-scale

After the analog input value returns to 10.2 V, turn on and off the alarm clear request.

Clearing the over-limit will result in the following status.

- The over-limit detection flag is cleared.
- The alarm code stored for the latest alarm code is cleared.



# Digital clipping function

Function that specifies the maximum A/D conversion value as 4000 and the minimum value as 0 when voltage is input that exceeds the input range.

## Corresponding devices

The devices which are used by the digital clipping function are listed below.

Name	CH1	CH2
Digital clipping enable/disable setting	SM6029	SM6069

## Setting methods

Enable digital clipping for the channels on which to use the digital clipping function.

Name	Allowable setting range	Default value
Digital clipping enable/disable setting	0: Enabled	1: Disabled
	1: Disabled	

### Point

- When the digital clipping function is disabled: digital output range (0 to 4095)
- When the digital clipping function is enabled: digital output range (0 to 4000)

## Operation

The following describes the operation of the digital clipping function.

This function specifies the maximum A/D conversion value as 4000 and the minimum value as 0 when voltage is input that exceeds the input range.

### Point

Scaling and shift processing occur after digital clipping.

## Precautions

The scaling function operates as follows when not used with the digital clipping function.

The value after scaling will exceed the scaling upper limit value when a voltage is input that exceeds the voltage range.

# Scaling function

Function that converts user-defined maximum and minimum digital values in accordance with a configured scale.

## Corresponding devices

The devices which are used by the scaling function are listed below.

Name	CH1	CH2
A/D conversion scaling enable/disable setting	SM6028	SM6068
A/D conversion error flag	SM6059	SM6099
Scaling upper limit value	SD6028	SD6068
Scaling lower limit value	SD6029	SD6069
A/D conversion latest error code	SD6059	SD6099

## Setting methods

The procedure to use the scaling function is described below.

### 1. Disable scaling.

Name	Allowable setting range	Default value
Scaling enable/disable setting	0: Enabled	1: Disabled
	1: Disabled	

### 2. Set the scaling upper limit value/scaling lower limit value.

Set the scaling upper limit value to a value corresponding to the maximum A/D conversion value in the range (4000). Set the scaling lower limit value to a value corresponding to the minimum A/D conversion value in the range (0)

Name	Allowable setting range	Default value
Scaling upper limit value	-32768 to +32767 (Upper limit value ≠ Lower limit value)	0
Scaling lower limit value		

### 3. Enable scaling.

## Operation

The output digital value is scaled within a range between the user-defined scaling upper limit value and the scaling lower limit value.

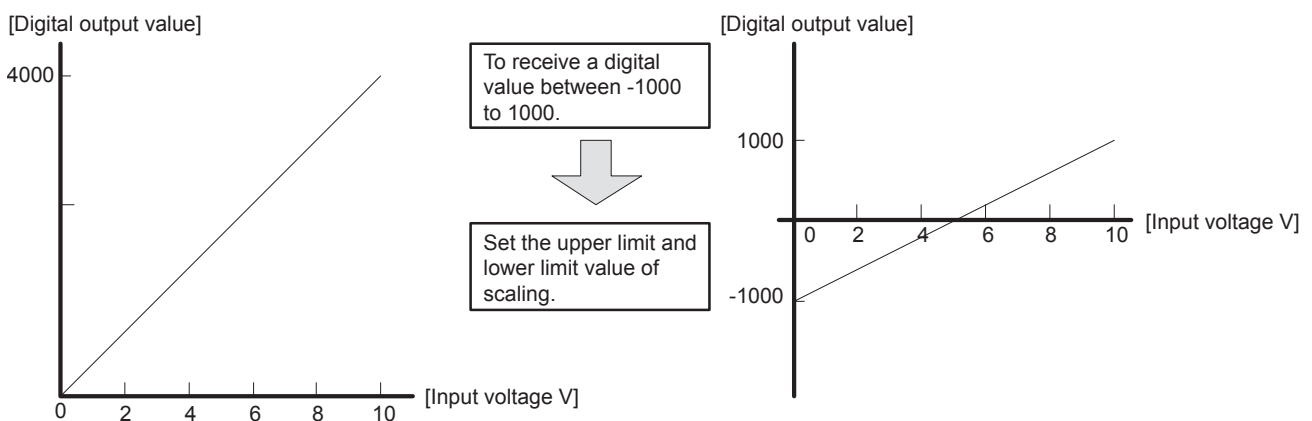

## ■ Calculation method of the scaling value

The value used is calculated from the following expression. (The value below the decimal point is rounded.)

$$\text{Value after scaling} = \frac{\text{Digital output value} \times (\text{scaling upper limit value} - \text{scaling lower limit value})}{4000} + \text{Scaling lower limit value}$$

### Point

- The max. resolution will not increase even if the scaling upper limit value and the scaling lower limit value are set such that each digit is smaller than the max. resolution.
- If the scaling upper limit value is set lower than the scaling lower limit value, the digital operation value decreases as the input voltage increases.

## Precautions

If both the scaling function and the digital clipping function are used simultaneously, the scaling calculation will be performed for the resulting digital operation value after digital clipping.

## Shift function

Function to add the set conversion value shift amount to the A/D conversion value and store the digital operation value. Changes to the conversion value shifting amount will be reflected in the digital operation value in real time, allowing fine adjustments to be easily performed during system startup.

## Corresponding devices

The devices which are used by the shift function are listed below.

Name	CH1	CH2
Conversion value shift amount	SD6030	SD6070

## Setting methods

Sets the conversion value shift amount for the channel for which you want to use the conversion value shift.

Name	Allowable setting range	Default value
Conversion value shift amount	-32768 to +32767	0

### Point

This function does not need to be set in advance. The user can perform conversion value shifts at any time.

## Operation

Adds a shifting amount to the A/D conversion value. The A/D conversion value with the added shift is stored as the digital operation value.

When the digital operation value resulting from the shift processing exceeds the range between -32768 and +32767, the value is fixed to the lower limit (-32768) or the upper limit (32767).

When using the sampling processing, the shift amount is added for every conversion cycle. When using the averaging processing, the shift amount is added for every averaging process cycle. The results are stored as the digital operation value.

When using the scaling function at the same time, shift processing is performed on the resulting value after scaling processing.

## Precautions

When the shift function, digital clipping function, and scaling function are used together, the added shift is applied to the value after digital clipping and scaling, which results in a digital operation value range between -32768 to +32767.

# Maximum value/minimum value hold function

Function that holds the minimum and maximum digital operation values.

## Corresponding devices

The devices which are used by the function to hold minimum and maximum values are listed below.

Name	CH1	CH2
Maximum value/minimum value reset completed flag	SM6025	SM6065
Maximum value reset request	SM6026	SM6066
Minimum value reset request	SM6027	SM6067
Maximum value	SD6026	SD6066
Minimum value	SD6027	SD6067

## Setting methods

The user does not need to configure any settings.

## Operation

The maximum value and minimum value of the digital operation value are stored in the maximum value and minimum value of the special registers for each channel.

Turning on the maximum and minimum value reset request resets the maximum and minimum values for corresponding channel. After the reset, the update of values with current values starts again. The maximum value/minimum value reset completed flag will turn on.

The maximum and minimum value reset requests are not turned off automatically. To reset the values again, it is necessary to turn the requests OFF.

When the averaging processing, digital clipping function, scaling function, and shift function are enabled, the values resulting after the averaging processing, digital clipping, scaling, and a shift addition are stored as the maximum value and minimum value.

# Warning output function

The warning output flag for the corresponding channel turns ON when the digital operation value is equal to or greater than the process alarm upper upper limit value, is equal to or lower than the process alarm lower lower limit value, or falls within the warning output range.

## Corresponding devices

The devices which are used by the warning output function are listed below.

Name	CH1	CH2
Warning output flag (process alarm upper limit)	SM6031	SM6071
Warning output flag (process alarm lower limit)	SM6032	SM6072
Warning output setting (process alarm)	SM6033	SM6073
A/D conversion alarm clear request	SM6057	SM6097
A/D conversion alarm flag	SM6058	SM6098
Process alarm upper upper limit value	SD6031	SD6071
Process alarm lower upper limit value	SD6032	SD6072
Process alarm upper lower limit value	SD6033	SD6073
Process alarm lower lower limit value	SD6034	SD6074
A/D conversion latest alarm code	SD6058	SD6098

## Setting methods

The procedure to use the warning output function is described below.

1. Disable the warning output setting (process alarm).

Name	Allowable setting range	Default value
Warning output setting (process alarm)	0: Enabled	1: Disabled
	1: Disabled	

2. Set the upper limit and lower limit values for the process alarm.

Four levels of values from the process alarm upper upper limit value to the process alarm lower lower limit value can be set for each channel that uses the warning output function (process alarm).

Name	Allowable setting range	Default value
Process alarm upper upper limit value	-32768 to +32767 (Upper-upper limit value ≥ Upper-lower limit value ≥ Lower-upper limit value ≥ Lower-lower limit value)	0
Process alarm lower upper limit value		
Process alarm upper lower limit value		
Process alarm lower lower limit value		

3. Enable the warning output setting (process alarm).

## Operation

The warning output flag (process alarm upper limit) or the warning output flag (process alarm lower limit) turns ON when the digital operation value is equal to or greater than the process alarm upper upper limit value, or is equal to or lower than the process alarm lower lower limit value, and the conditions to output a warning are satisfied.

This function executes for each averaging time and averaging count configured when time average and count average are specified. This function executes every conversion cycle when other A/D conversion methods are specified (Sampling processing and moving average).

The warning output flag (process alarm upper limit) or the warning output flag (process alarm lower limit) turns OFF after the warning is output when the digital operation value is lower than the process alarm upper lower limit value, or is larger than the process alarm lower upper limit value, and the conditions to output a warning are no longer satisfied.

However, the alarm code stored for the A/D conversion latest alarm code is not cleared.

To clear the alarm code stored in the latest A/D conversion alarm code, turn on and off the A/D conversion alarm clear request after all warning output flags (process alarm upper limit/process alarm lower limit) return to the OFF status. At this time, the A/D conversion alarm occurrence flag is also turned OFF.

## Precautions

When using the digital clipping function, scaling function, and shift function, the digital operation value resulting from digital clipping, scaling, and shift additions becomes the detection target for outputting a warning. Make sure to set the process alarm upper limit and lower limit values with regard to scaling and shift additions.

## Event history function

This function collects errors from built-in analog input of CPU module, and keeps them in the SD memory card, and data memory or battery backed built-in RAM of the CPU module.

The event information collected by the CPU module can be displayed on GX Works3 to check the occurrence history in chronological order.

Event type	Classification	Description
System	Error	An error detected by the self diagnostics in each module.

## Setting procedure

The event history function can be set from the event history setting window of GX Works3. For the setting procedure, refer to the following.

 Page 131 Event History Function

## Displaying event history

Access the menu of GX Works3. For details on the operating procedure and how to view the contents, refer to the following.

 GX Works3 Operating Manual

# 36.4 Functions (Analog Output)

This section describes the functions of the built into analog the FX5U CPU module and the setting procedures for those functions.

## Processing of each function

The functions are processed in the order shown below.

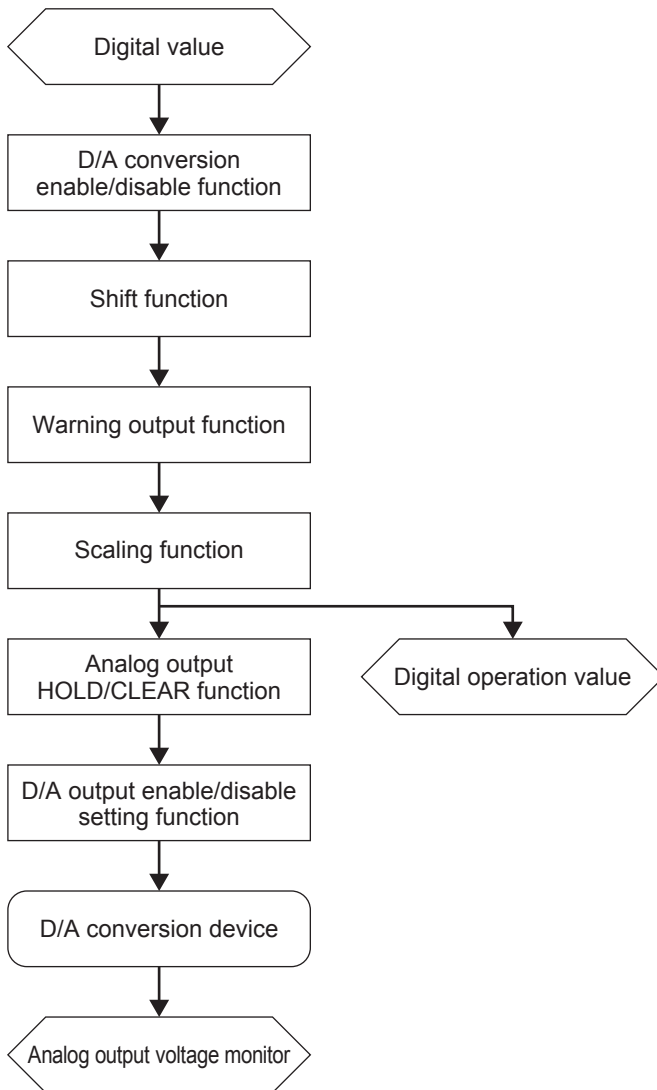

### Digital value

The input digital value is stored.

### Digital operation value

A value obtained by operating a digital value using the scaling function or shift function. When any of the functions is not used, the same value as the digital value is stored.

### Analog output voltage monitor

The output analog value is displayed. Voltage is displayed in the following units.

Voltage: mV

## D/A conversion enable/disable function

Function to enable or disable D/A conversion per channel.

When analog output is not used, the conversion process time can be reduced by disabling conversion.

### Corresponding devices

The devices which are used by the D/A conversion enable/disable setting function are listed below.

Name	CH1
D/A conversion enable/disable setting	SM6180

### Setting methods

D/A conversion is enabled/disabled for each channel by the setting to enable/disable D/A conversion.

Name	Allowable setting range	Default value
D/A conversion enable/disable setting	0: Enable D/A conversion	1: Disable D/A conversion
	1: Disable D/A conversion	

### Operation

D/A conversion is performed for the digital output value only for the channels for which D/A conversion has been enabled by the D/A conversion enable/disable setting, and output is performed based on the converted analog value for the channels whose D/A output is set to ON.

## D/A output enable/disable setting function

This function can specify whether to output the D/A conversion value or output an offset value (HOLD setting value) for each channel.

### Corresponding devices

The devices which are used by the D/A output enable/disable setting function are listed below.

Name	CH1
D/A output enable/disable setting	SM6181

### Setting methods

D/A output is enabled/disabled for each channel by the setting to enable/disable D/A output.

Name	Allowable setting range	Default value
D/A output enable/disable setting	0: Enable D/A output	1: Disable D/A output
	1: Disable D/A output	

### Operation

Output is performed based on the digital output value only for the channels for which D/A output has been enabled by the D/A output enable/disable setting. An offset value (HOLD setting value) is output when the D/A output enable/disable flag is set to disable D/A output.



# Analog output HOLD/CLEAR function

Sets how to operate digital values to be converted to analog signals depending on the operation status of the CPU module (RUN, STOP, and STOP error). Select it from the following three ways: clear the value to 0; hold the previous value; set to a specified value.

## Corresponding devices

The devices which are used by the analog output HOLD/CLEAR function are listed below.

Name	CH1
D/A conversion enable/disable setting	SM6180
HOLD/CLEAR setting	SD6183
HOLD setting value	SD6184

## Setting methods

The procedure to use the analog output HOLD/CLEAR function is described below.

### 1. Disable D/A conversion.

Name	Allowable setting range	Default value
D/A conversion enable/disable setting	0: Enable	1: Disable
	1: Disable	

### 2. Set the HOLD/CLEAR function setting.

Set for the HOLD/CLEAR function setting.

Name	Allowable setting range	Default value
HOLD/CLEAR function setting	0: CLEAR	0
	1: Previous Value (Hold)	
	2: Setting Value	

### 3. Set the HOLD setting value.

When "2: Setting Value" is chosen in the above 2, a value is set to HOLD setting value.

Name	Allowable setting range	Default value
HOLD setting value	-32768 to +32767	0

### 4. Enable D/A conversion.

## Operation

The following table lists the resulting analog output status depending on the combined configuration of the analog output HOLD/CLEAR function and the D/A output enable/disable flag.

CPU module status	D/A output enable/disable setting	HOLD/CLEAR setting	Output status
RUN	Enabled	All settings	Shift and scaling value
	Disabled	All settings	0
STOP	Enabled	CLEAR	0
	Enabled	Previous Value (Hold)	Shift and scaling value
	Enabled	Setting Value	Output the value set for the HOLD setting value
	Disabled	All settings	0
PAUSE	Enabled	All settings	Shift and scaling value
	Disabled	All settings	0
Error occurs when RUN state cannot operate	Enabled	All settings	0
	Disabled	All settings	0

# Analog output test when CPU module is in STOP status function

This function outputs a user-defined analog value by setting the output enable/disable flag to enabled when the CPU module is stopped, and changing the digital value.

## Corresponding devices

The devices that are used by analog test function when the CPU module is stopped are listed below.

Name	CH1
D/A conversion enable/disable setting	SM6180
D/A output enable/disable setting	SM6181
Digital value	SD6180

## Setting methods

The procedure to use the analog test function is described below.

### 1. Change the operation conditions setting.

The following conditions must be satisfied to enable the analog output test.

Description	Setting value
D/A conversion enable/disable	Conversion enabled
D/A output enable/disable	Output enabled

### 2. Update the digital value.

Set the digital value corresponding to the analog value to be output as a digital value.

## Operation

The digital input value will be converted to an analog signal by D/A conversion and be output regardless of whether the CPU module is in the RUN state or STOP state.

The settings for the shift function, scaling function, and warning output function are valid during the analog output test.

## Precautions

Even when the analog output HOLD/CLEAR function is operating, analog output can be changed by this function.

# Scaling function

Function that converts user-defined maximum and minimum digital values in accordance with a configured scale.

## Corresponding devices

The devices which are used by the scaling function are listed below.

Name	CH1
Scaling enable/disable setting	SM6188
Scaling upper limit value	SD6188
Scaling lower limit value	SD6189

## Setting methods

The procedure to use the scaling function is described below.

### 1. Disable scaling.

Name	Allowable setting range	Default value
Scaling enable/disable setting	0: Enabled	1: Disabled
	1: Disabled	

### 2. Set the scaling upper limit value/scaling lower limit value.

The allowable setting range is shown in the following table.

Name	Allowable setting range	Default value
Scaling upper limit value	-32768 to +32767	0
Scaling lower limit value	(Upper limit value ≠ Lower limit value)	

### 3. Enable scaling.

## Operation

Scaling is performed on the resulting value after shift processing is performed on the set digital value using the scaling upper limit value and scaling lower limit value. The value resulted from scaling is used for D/A conversion.

An example of scaling setting is shown below.

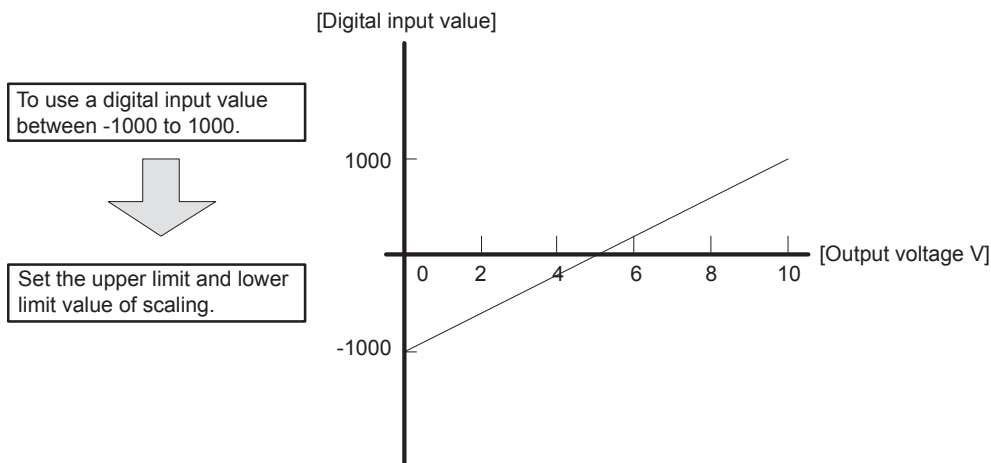

### ■ Calculation method of the scaling value

When using the factory settings for the output range.

$$\text{Value after scaling} = \frac{4000}{\text{Scaling upper limit value} - \text{scaling lower limit value}} \times (\text{digital input value} - \text{scaling lower limit value})$$

## Shift function

Function that adds the set input value shift amount to the digital value.

Changes to the input value shift amount will be reflected in the digital operation value in real time, allowing fine adjustments to be easily performed during system startup.

### Corresponding devices

The devices which are used by the shift function are listed below.

Name	CH1
Input value shift amount	SD6190

### Setting methods

Set the desired input value shift amount when performing a shift addition.

Name	Allowable setting range	Default value
Input value shift amount	-32768 to +32767	0

### Operation

When the added digital value resulting from the shift processing exceeds the range between -32768 and +32767, the value is fixed to the lower limit (-32768) or the upper limit (32767).

After the value is written for the input value shift amount, the input value shift amount is added to the digital value.

### Precautions

The scaling function and the warning output function are executed for the digital value to which the shift amount has been added.

## Warning output function

Function that checks the digital value set for output against the warning output upper limit and lower limit values configured in advance for each channel, and outputs a warning when the value is outside the set range.

### Corresponding devices

The devices which are used by the warning output function are listed below.

Name	CH1
Warning output upper limit value flag	SM6191
Warning output lower limit value flag	SM6192
Warning output setting	SM6193
D/A conversion alarm clear request	SM6217
D/A conversion alarm flag	SM6218
Warning output upper limit value	SD6191
Warning output lower limit value	SD6192
D/A conversion latest alarm code	SD6218

### Setting methods

The procedure to use the warning output function is described below.

1. Disable the warning output setting.

Name	Allowable setting range	Default value
Warning output setting	0: Enable	1: Disable
	1: Disable	

**2.** Set the warning output upper limit value and warning output lower limit value.

Warning output upper limit value and warning output lower limit value can be set for each channel that uses the warning output function.

Name	Allowable setting range	Default value
Warning output upper limit value	-32768 to +32767 (Upper limit value > Lower limit value)	0
Warning output lower limit value		

**3.** Enable the warning output setting.

**Operation**

The judgment to output a warning is based on the resulting value after shift processing is performed on the digital input value. The warning output upper limit value flag turns ON for the corresponding channel when the input digital value exceeds the warning output upper limit value, and the warning output lower limit value flag turns ON when the input digital value is less than the warning output lower limit value.

Details of the warning output upper limit value flag are shown in the table below.

Name	Allowable setting range
Warning output upper limit value flag	0: Normal
	1: Upper limit alarm ON

Details of the warning output lower limit value flag are shown in the table below.

Name	Allowable setting range
Warning output lower limit value flag	0: Normal
	1: Lower limit alarm ON

The set warning output upper and lower limit values are used as the digital values for D/A conversion when there is a warning. After a warning occurs and the digital value becomes less than the warning output upper limit value or greater than the warning output lower limit value, the analog output value returns to the normal value. However, the warning output upper limit flag, warning output lower limit flag, D/A conversion alarm occurrence flag, and alarm code stored in "D/A conversion latest alarm code" are not cleared.

The following describes the procedure to clear the warning output.

After setting the digital value to a value smaller than the warning output upper limit value or larger than the warning output lower limit value, turn on and off the D/A conversion alarm clear request.

**Precautions**

- When using the scaling function and shift function, the digital value resulting from scaling and shift additions becomes the detection target for outputting a warning. Make sure to set the warning output upper limit and lower limit values with regard to scaling and shift additions.
- A warning will be output when the digital value exceeds the warning output upper limit value or when the digital value is less than the warning output lower limit value.

## Event history function

This function collects errors from built-in analog output of CPU module, and keeps them in the SD memory card, and data memory or battery backed built-in RAM of the CPU module.

The event information collected by the CPU module can be displayed on GX Works3 to check the occurrence history in chronological order.

Event type	Classification	Description
System	Error	An error detected by the self diagnostics in each module.

### Setting procedure

The event history function can be set from the event history setting window of GX Works3. For the setting procedure, refer to the following.

📖 Page 131 Event History Function

### Displaying event history

Access the menu of GX Works3. For details on the operating procedure and how to view the contents, refer to the following.

📖 GX Works3 Operating Manual

## 36.5 Function (PID Control Via Instruction)

### Outline of function

The PID instruction is used to perform PID control. The PID instruction requires the system to calculate the output (MV) value from the measured (PV) value. Through combining the P (proportional) action, I (integral) action, and D (derivative) action, the target (SV) value can be obtained.

- Alarm output function

The alarm function can be set for input variation (measured value) or output variation (value).

- Setting limit values

The upper limit and lower limit can be set for the output value.

- Auto-tuning function

The proportional gain (KP), integral time (TI) and differential time (TD) can be set automatically for both the limit cycle method and step response method.

- Operation method of the PID instruction

Both PID speed type operation and measured value differential type operation are executed.

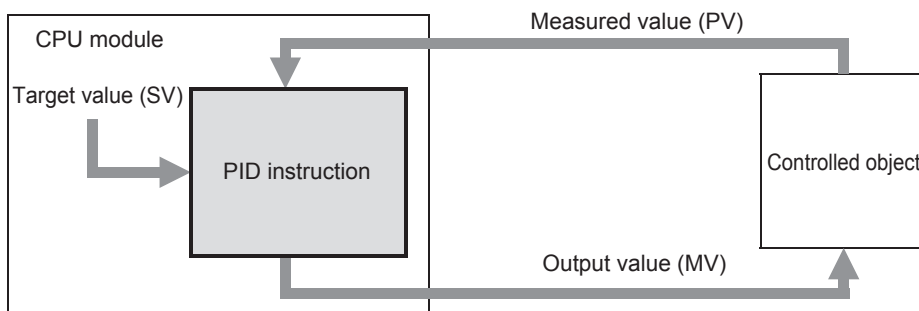

## Basic operation expressions in PID instruction

The PID instruction executes using the speed type or measured value differential type operation expression. According to the content of b0 of (s3)+1 "operation setting (ACT)" specified by (s3) in the PID control, either forward operation or backward operation is executed. Each value required in the operation is specified by a corresponding parameter (s3) or later.

### Basic operation expression for PID control

Operation setting (ACT) (s3+1: b0)	Operation expression	The meaning of the signs
Forward operation (OFF)	$\Delta MV = KP \left\{ (EV_n - EV_{n-1}) + \frac{TS}{TI} EV_n + D_n \right\}$ $EV_n = PV_{nf} - SV$ $D_n = \frac{TD}{TS + KD \cdot TD} (-2PV_{nf-1} + PV_{nf} + PV_{nf-2}) + \frac{KD \cdot TD}{TS + KD \cdot TD} \cdot D_{n-1}$ $MV_n = \sum \Delta MV$	EV <sub>n</sub> : Deviation in sampling at this time EV <sub>n-1</sub> : Deviation in previous cycle SV: Target value PV <sub>nf</sub> : Measured value in sampling at this time (after filter) PV <sub>nf-1</sub> : Measured value in previous cycle (after filter) PV <sub>nf-2</sub> : Measured value in two cycles before (after filter) ΔMV: Output variation MV <sub>n</sub> : Output value at this time D <sub>n</sub> : Differential term at this time D <sub>n-1</sub> : Differential term in previous cycle TS: Sampling cycle KP: Proportional gain TI: Integral constant TD: Differential constant KD: Differential gain
Backward operation (ON)	$\Delta MV = KP \left\{ (EV_n - EV_{n-1}) + \frac{TS}{TI} EV_n + D_n \right\}$ $EV_n = SV - PV_{nf}$ $D_n = \frac{TD}{TS + KD \cdot TD} (2PV_{nf-1} - PV_{nf} - PV_{nf-2}) + \frac{KD \cdot TD}{TS + KD \cdot TD} \cdot D_{n-1}$ $MV_n = \sum \Delta MV$	EV <sub>n</sub> : Deviation in sampling at this time EV <sub>n-1</sub> : Deviation in previous cycle SV: Target value PV <sub>nf</sub> : Measured value in sampling at this time (after filter) PV <sub>nf-1</sub> : Measured value in previous cycle (after filter) PV <sub>nf-2</sub> : Measured value in two cycles before (after filter) ΔMV: Output variation MV <sub>n</sub> : Output value at this time D <sub>n</sub> : Differential term at this time D <sub>n-1</sub> : Differential term in previous cycle TS: Sampling cycle KP: Proportional gain TI: Integral constant TD: Differential constant KD: Differential gain

### ■ Expression for calculating the measured value (after the filter) in sampling at this time (PV<sub>nf</sub>)

The value "PV<sub>nf</sub>" is obtained from the following expression based on the read measured value.

Measured value after filter:  $PV_{nf} = PV_n + L (PV_{nf-1} - PV_n)$

PV<sub>n</sub>: Measured value in sampling at this time

L: Filter coefficient

PV<sub>nf-1</sub>: Measured value in previous cycle (after filter)

# How to use PID instruction

This instruction executes PID control which changes the output value according to the input variation.

For details on the PID instruction, refer to the following manual.

📖 MELSEC iQ-F FX5 Programming Manual (Instructions, Standard Functions/Function Blocks)

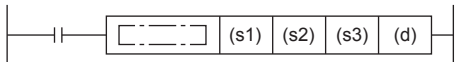
Ladder diagram	Structured text
	<pre>ENO:=PID(EN,s1,s2,s3,d);</pre>

## FBD/LD

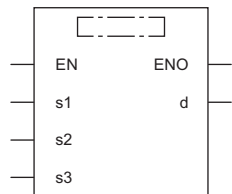

## Setting data

### ■ Descriptions, ranges, and data types

Operand	Description	Range	Data type	Data type (label)
(s1)	Device number storing the target value (SV)	-32768 to +32767	16-bit signed binary	ANY16 <sup>*1</sup>
(s2)	Device number storing the measured value (PV)	-32768 to +32767	16-bit signed binary	ANY16 <sup>*1</sup>
(s3)	Device number storing PID parameters	1 to 32767	16-bit signed binary	ANY16 <sup>*1</sup>
(d)	Device number storing the output value (MV)	-32768 to +32767	16-bit signed binary	ANY16 <sup>*1</sup>
EN	Execution condition	—	Bit	BOOL
ENO	Execution result	—	Bit	BOOL

\*1 When setting using a label, use the global label assigned to the device.

### ■ Applicable devices

Operand	Bit	Word			Double word		Indirect specification	Constant			Others
	X, Y, M, L, SM, F, B, SB, S	T, ST, C, D, W, SD, SW, R	U□\G□	Z	LC	LZ		K, H	E	\$	
(s1)	—	○ <sup>*1</sup>	○	—	—	—	—	—	—	—	—
(s2)	—	○ <sup>*1</sup>	○	—	—	—	—	—	—	—	—
(s3)	—	○ <sup>*1</sup>	—	—	—	—	—	—	—	—	—
(d)	—	○ <sup>*1</sup>	○	—	—	—	—	—	—	—	—

\*1 Only D, SD, R can be used.

## Processing details

- Once the target value (s1), measured value (s2) and PID parameters (s3) to (s3)+6 are set and the program is executed, the operation result (MV) is transferred to the output value (d) at every sampling time. The sampling time is specified by (s3).

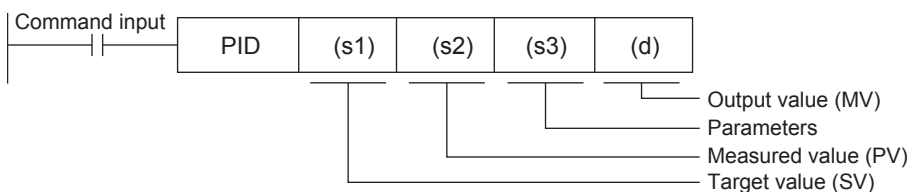



■Set item

Set item		Description	Occupied points
(s1)	Target value (SV)	The target value (SV) is set. The PID instruction does not change the settings. [Caution on using the auto-tuning (limit cycle method)] If the target value for auto-tuning is different from the target value in the PID control, it is necessary to set a value to which a bias value is added, and then store the actual target value when the auto-tuning flag turns OFF.	1 point
(s2)	Measured value (PV)	This is the input value of the PID operation. It is necessary to read a normal measurement data before the execution of the PID operation for the measurement value of PID (PV). If an input value from an analog input is used for the PID operation, use caution to its conversion time.	1 point
(s3)	Parameter	PID control 25 devices are occupied from the head device specified in (s3)	25 points
		Auto-tuning: In the limit cycle method 29 devices are occupied from the head device specified in (s3)	29 points
		Auto-tuning: In the step response method ((s3)+1: b8 is set to OFF) 25 devices are occupied from the head device specified in (s3)	25 points
		Auto-tuning: In the step response method ((s3)+1: b8 is set to ON) 28 devices are occupied from the head device specified in (s3)	28 points
(d)	Output value (MV)	PID control (normal processing) The user sets the initial output value before driving the instruction. After that, the operation result is stored.	1 point
		Auto-tuning: In the limit cycle method The Upper Limit Value (ULV) or Lower Limit Value (LLV) value is automatically output during auto-tuning. The specified MV value is output when auto-tuning is finished.	
		Auto-tuning: In the step response method The user sets the step output value before driving the instruction. The MV value is not changed by PID instruction during auto-tuning.	

■Precautions for using the PID instruction

For the precautions for using the PID instruction, refer to the following manual.

📖 MELSEC iQ-F FX5 Programming Manual (Instructions, Standard Functions/Function Blocks)

## Relationship between parameter setting and auto-tuning

### When auto-tuning is not executed (parameter setting)

It is necessary to write the set value of the parameters (s3) to (s3)+6 by means such as the MOV instruction before starting the PID operation when auto-tuning is not executed. If a device with a latch setting is specified, the setting data is retained even after the power to the CPU module is turned OFF; therefore, the writing at the 2nd power ON is not required.

For details on parameters, refer to 📖 Page 568 Parameter.

### When auto-tuning is executed

The proportional gain ((s3)+3), integral time ((s3)+4) and differential time ((s3)+6) are important constants for executing the auto-tuning function described later and for optimizing the PID control. These constants can be set automatically.

For a detailed description of auto-tuning, refer to 📖 Page 580 Auto-tuning.

# Parameter

Set item	Description/Setting range		Remarks	
(s3)	Sampling time (TS)	1 to 32767 (ms)	It cannot be shorter than operation cycle of the PLC.	
(s3)+1	Operation setting (ACT)	b0	0: Forward operation 1: Backward operation	Operation direction
		b1	0: Input variation alarm is invalid 1: Input variation alarm is valid	—
		b2	0: Output variation alarm is invalid 1: Output variation alarm is valid	Do not set b2 and b5 to ON at the same time.
		b3	Not used	—
		b4	0: Auto-tuning is not executed. 1: Auto-tuning is executed	—
		b5	0: Upper and lower limits of output value are not valid 1: Upper and lower limits of output value are valid	Do not set b2 and b5 to ON at the same time.
		b6	0: Step response method 1: Limit cycle method	Select auto-tuning mode.
		b7 <sup>*2</sup>	0: Overshoot suppression processing invalid (FX3U compatible) 1: Overshoot suppression processing valid	When b7 is ON, the overshoot suppression processing is performed.
		b8 <sup>*2</sup>	0: Without the hunting suppression processing (FX3U compatible) 1: With the hunting suppression processing	This is valid when b4 is ON and b6 is OFF. When b8 is ON, the hunting suppression processing is performed.
		b9 to b15	Not used	—
(s3)+2	Input filter constant ( $\alpha$ )	0 to 99[%]	When "0" is set, input filter is not provided.	
(s3)+3	Proportional gain (KP)	1 to 32767[%]	—	
(s3)+4	Integral time (TI)	0 to 32767[×100ms]	When "0" is set, it is handled as "∞" (no integration).	
(s3)+5	Differential gain (KD)	0 to 100[%]	When "0" is set, differential gain is not provided.	
(s3)+6	Differential time (TD)	0 to 32767[×10ms]	When "0" is set, differential is not executed.	
(s3)+7 to ⋮ (s3)+19	These devices are occupied for internal processing of PID operation. Do not change data.			
(s3)+20 <sup>*1</sup>	Input variation (incremental) alarm set value	0 to 32767	It is valid when b1 of the operation setting (ACT) ((s3)+1) is "1".	
(s3)+21 <sup>*1</sup>	Input variation (decremental) alarm set value	0 to 32767	It is valid when b1 of the operation setting (ACT) ((s3)+1) is "1".	
(s3)+22 <sup>*1</sup>	Output variation (incremental) alarm set value	0 to 32767	It is valid when b2 and b5 of the operation setting (ACT) ((s3)+1) are "1" and "0".	
	Output upper limit set value	-32768 to +32767	It is valid when b2 and b5 of the operation setting (ACT) ((s3)+1) are "0" and "1".	
(s3)+23 <sup>*1</sup>	Output variation (decremental) alarm set value	0 to 32767	It is valid when b2 and b5 of the operation setting (ACT) ((s3)+1) are "1" and "0".	
	Output lower limit set value	-32768 to +32767	It is valid when b2 and b5 of the operation setting (ACT) ((s3)+1) are "0" and "1".	
(s3)+24 <sup>*1</sup>	Alarm output	b0	0: Input variation (incremental) is not exceeded. 1: Input variation (incremental) is exceeded.	It is valid when b1 and b2 of the operation setting (ACT) ((s3)+1) are "1".
		b1	0: Input variation (decremental) is not exceeded. 1: Input variation (decremental) is exceeded.	
		b2	0: Output variation (incremental) is not exceeded. 1: Output variation (incremental) is exceeded.	
		b3	0: Output variation (decremental) is not exceeded. 1: Output variation (decremental) is exceeded.	
<p>■The following setting is required when using the limit cycle method (b6 of the operation setting (ACT) ((s3)+1) is "1").</p>				
(s3)+25	PV value threshold (hysteresis) width (SHPV)	Set it according to measured value (PV) fluctuation.	The setting below is required when the limit cycle method is used (when the operation setting (ACT) b6 is set to ON).	
(s3)+26	Output value upper limit (ULV)	Set maximum value (ULV) of output value (MV).		
(s3)+27	Output value lower limit (LLV)	Set minimum value (LLV) of output value (MV).		
(s3)+28	Wait setting from end of tuning cycle to start of PID control (KW)	-50 to +32717[%]		

Set item	Description/Setting range	Remarks
<p>■The following setting is required when using the timeout time after maximum ramp (b6 and b8 of the operation setting (ACT) ((s3)+1) are "0" and "1") with the step response method.</p>		
(s3)+25	Timeout time setting value after maximum ramp (R) detection	1 to 32767[s]
(s3)+26 (s3)+27	These devices are occupied for internal processing of PID operation. Do not change data.	

\*1 (s3)+20 to +24 become used only if b1, b2, or b5 are set to "1" to determine the action (ACT) (s3)+1.

\*2 For supported version of each setting, refer to  Page 966 Added and Enhanced Functions.

## Details of parameters

This chapter describes the details of parameters.

### Sampling time (s3)

Set the cycle time (ms) for the PID operation. Setting range: 1 to 32767 (ms)

- In PID control and auto-tuning (Limit cycle method)

Set the sampling time longer than the operation cycle of the PLC.

- In auto-tuning (Step response method)

Set the sampling time to 1000 ms (= 1 second) or more.

#### ■Maximum error

The maximum error of the sampling time (TS) is from "- (one operation cycle+1 ms)" to "+ (one operation cycle)."

- When the sampling time (TS) is a small value

Fluctuation of the maximum error described above may cause a problem. In such a case, execute the PID instruction in the constant scan mode, or program it in a timer interrupt routine.

- When the sampling time (TS) is shorter than one operation cycle of the PLC

A PID operation error occurs, however when PID operation is executed, the sampling time (TS) is equal to the operation cycle of the PLC. In such a case, use the PID instruction in a timer interrupt, and clear (s3)+7 just before executing the PID instruction.

### Operation setting (s3)+1

#### ■Forward operation/backward operation

Set the PID control direction (forward or backward).

- During auto-tuning for the limit cycle method

It is necessary to set the PID control direction (forward or backward) for auto-tuning.

- During auto-tuning for the step response method

The PID control direction (forward or backward) is not required, as the direction is automatically set when auto-tuning is complete.

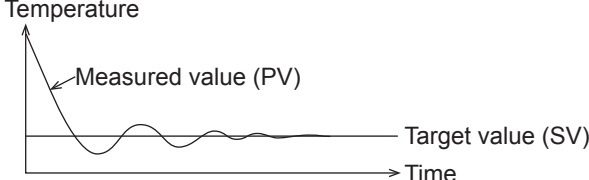
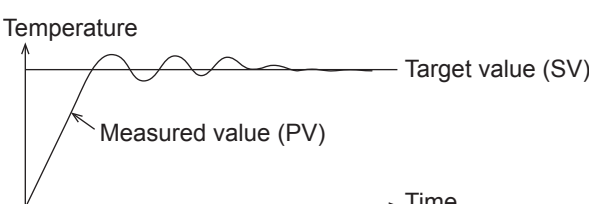
Operation setting (s3)+1: b0		Operation
Forward operation (b0=OFF)	As the measured value (PV) becomes larger than the target value (SV), the output (MV) increases. For example, cooling is a forward operation.	 <p>Temperature</p> <p>Measured value (PV)</p> <p>Target value (SV)</p> <p>Time</p>
Backward operation (b0=ON)	As the measured value (PV) becomes smaller than the target value (SV), the output (MV) increases. For example, heating is a backward operation.	 <p>Temperature</p> <p>Measured value (PV)</p> <p>Target value (SV)</p> <p>Time</p>

- Relationship between the forward/backward operation and the output (MV), measured value (PV) and target value (SV)

The relationship is as follows.

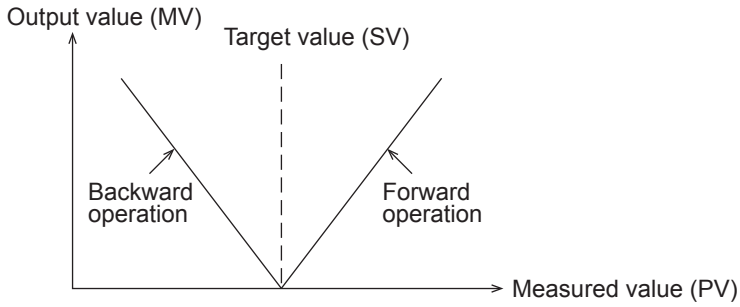

### ■ Alarm setting (for input variation and output variation)

If b1 and b2 in (s3) +1 are turned ON, the input variation and the output variation can be checked. The check is executed by following the values of (s3) +20 to (s3) +23.

These parameters can be set in (s3)+24.

For details on operation of alarm output, refer to Page 579 Alarm output (s3)+24.

- Input variation

If the input variation alarm is used, turn ON b1 in (s3) +1, and specify the input variation alarm set value.

Set item			Description/Setting range
Operation setting	(s3)+1: b1	Input variation alarm	ON: Used OFF: Not used
Input variation alarm set value	(s3)+20	Input variation (incremental) alarm set value	0 to 32767
	(s3)+21	Input variation (decremental) alarm set value	0 to 32767

- Output variation

If the output variation alarm is used, turn ON b2 in (s3) +1, and specify the output variation alarm set value.

When this function is used, make sure to turn OFF b5 of (s3) +1.

Set item			Description/Setting range
Operation setting	(s3)+1: b2	Output variation alarm	ON: Used OFF: Not used
	(s3)+1: b5	Output value upper/lower limit setting	Make sure to set it to OFF
Output variation alarm set value	(s3)+22	Output variation (incremental) alarm set value	0 to 32767
	(s3)+23	Output variation (decremental) alarm set value	0 to 32767



Variation means (Current value) - (Previous value)

## ■Overshoot suppression setting

Set the overshoot suppression processing. Especially, when the difference between the target value and current value is big, turn b7 of (s3)+1 ON. It is effective to suppress the overshoot during PID control operation.

Set item		Description/Setting range	
Operation setting	(s3)+1: b7	Overshoot suppression setting	ON: Used OFF: Not used

Temperature

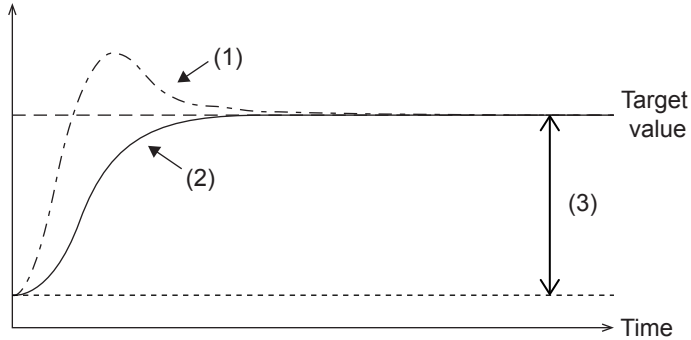

- (1) Overshoot suppression setting invalid
- (2) Overshoot suppression setting valid
- (3) If overshoot suppression setting is invalid, the first output variation  $\Delta MV$  is determined by this difference.

If the output variation rate  $\Delta MV$  is large during the initial scan time, the output will be suppressed in the following manner.

Output value (MV)

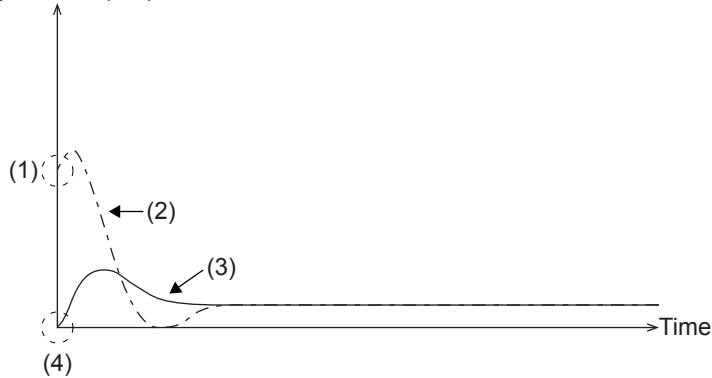

- (1) Initial output value is large
- (2) Overshoot suppression setting invalid
- (3) Overshoot suppression setting valid
- (4) The output variation rate is forcibly set to 0, so the initial output value will be 0. (When offset value offset is 0)

### Point

If the overshoot suppression setting is not used, the PID control operation with similar performance to the FX3 PLC will be executed.

## Upper and lower limits for output value

When the upper and lower limit settings of the output value are valid, the output value is as shown in the chart. The upper limit and lower limit of the output value can moderate the increase of the integral item in the PID control.

When using the upper limit and lower limit of the output value, make sure to set (s3)+1, b2 to OFF.

Set item			Description/Setting range
Operation setting	(s3)+1: b2	Output variation alarm	Make sure to set it to OFF
	(s3)+1: b5	Output value upper/lower limit setting	ON: Used OFF: Not used

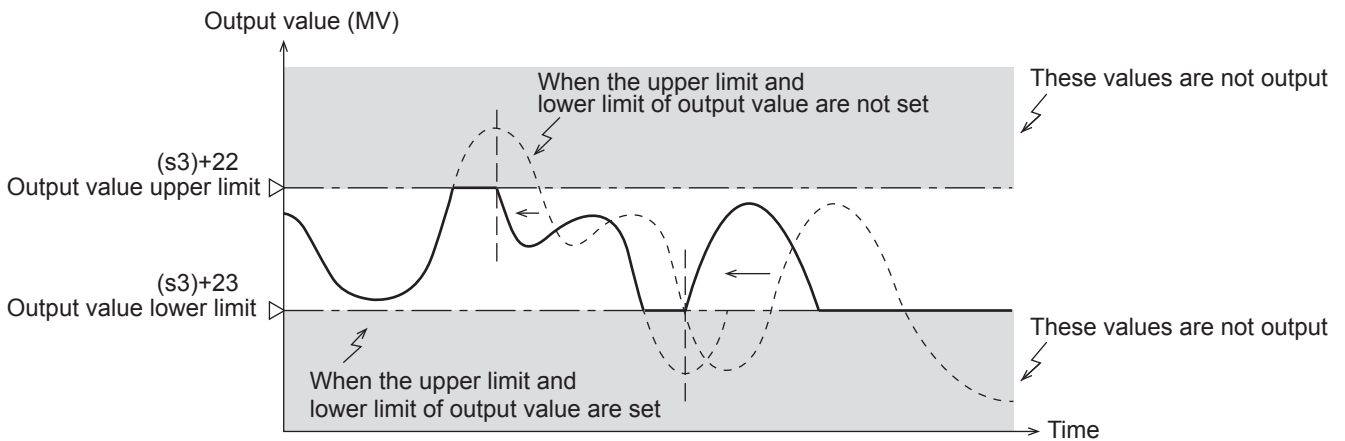

## Hunting suppression setting

Especially, if the step response method auto-tuning (Page 580 Auto-tuning) is executed in an environment where the measurement value varies temporarily because of noise of the sensor and analog input, auto-tuning may not be executed correctly and hunting may occur during PID control operation.

When b8 of (s3)+1 is turned ON and the current input value is less than the previous input value temporarily, auto-tuning is not completed until the set timeout time has elapsed. Therefore, maximum ramp (R) can be obtained correctly. (See the figure below.)

To use this function, turn ON b4 of (s3)+1 and OFF b6 of (s3)+1.

Set item			Description/Setting range
Operation setting	(s3)+1: b4	Auto-tuning	Make sure to set it to ON
	(s3)+1: b6	Auto-tuning mode	Make sure to set it to OFF
	(s3)+1: b8	Hunting suppression setting	ON: Used OFF: Not used
	(s3)+25	Timeout time setting value after maximum ramp (R) detection	1 to 32767 (second)

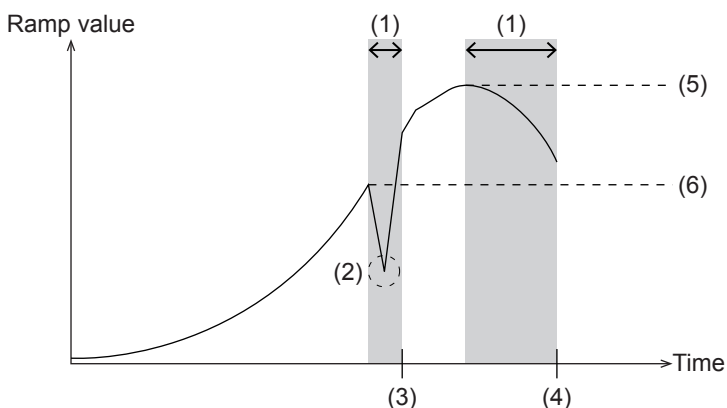

- (1) Timeout wait after maximum ramp (R) detection
- (2) A decrease of ramp caused by temporary deviation of the input value
- (3) Maximum ramp (R) is updated and auto tuning continues
- (4) Timeout wait after maximum ramp (R) detection
- (5) Maximum ramp (R) detection value at the end of auto tuning
- (6) Maximum ramp (R) detection value at the end of auto tuning when this setting is not used

The ramp value is obtained with the following formula.

Ramp value = (current input value - previous input value) ÷ sampling time

If the hunting suppression setting is not used, the PID control operation with similar performance to the FX3 PLC will be executed.

### Input filter constant (s3)+2

The input filter ( $\alpha$ ) is a software filter to reduce the fluctuation of the measured value (PV) caused by noise. By setting this time constant of the filter according to the control target characteristics and noise level, the effect of noise can be reduced. If the input filter value is too small, the filter effect is small. If the input filter value is too large, the input response is bad. Setting range: 0 to 99 (%).

Because the input filter ( $\alpha$ ) acts on the target value (SV), all of the proportional operation, integral operation and differential operation are affected.

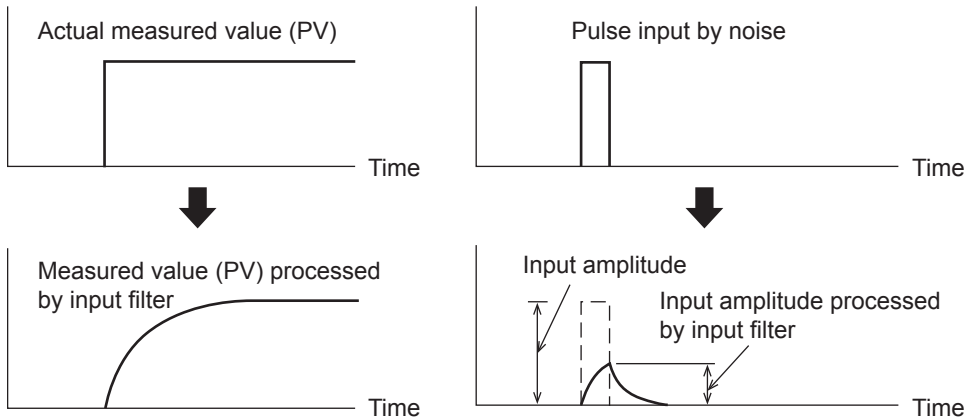

## Proportional gain (s3)+3

During the proportional operation, the output (MV) increases in proportion to the deviation (difference between the target value (SV) and the measured value (PV)). This deviation is called proportional gain (KP), and expressed in the following relational expression:

$$\text{Output (MV)} = \text{Proportional gain (KP)} \times \text{Deviation (EV)}$$

The reciprocal of the proportional gain (KP) is called proportional band.

As the proportional gain (KP) is larger (as shown in the example below), the motion to let the measured value (PV) be nearer to the target value (SV) becomes stronger.

Setting range: 1 to 32767 (%)

**Ex.**

Proportional operation (P operation) in backward operation (heating)

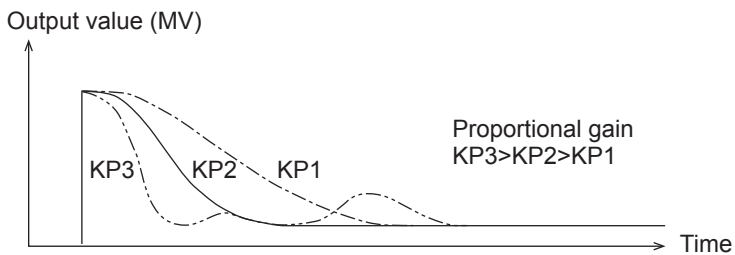
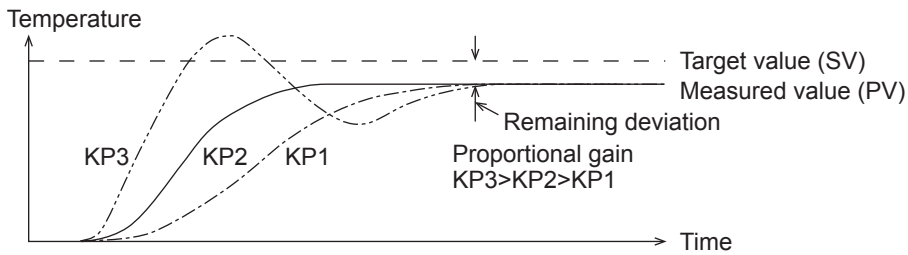

**Ex.**

Proportional operation (P operation) in forward operation (cooling)

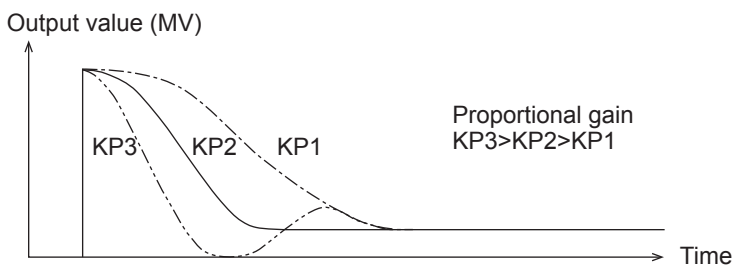
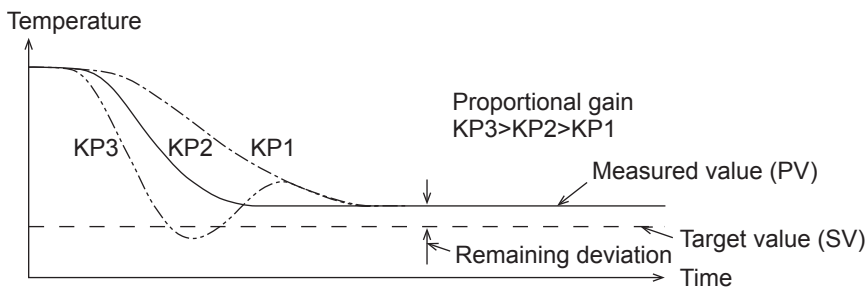



## Integral time (s3)+4

During the integral operation, the time after deviation is generated until the integral operation output becomes the proportional operation output. This is called integral time and is expressed as "TI".

As TI becomes smaller, the integral operation becomes stronger.

Setting range: 0 to 32767 ( $\times 100$  ms). "0" is handled as " $\infty$ " (no integration).

**Ex.**

PI operation in backward operation (heating)

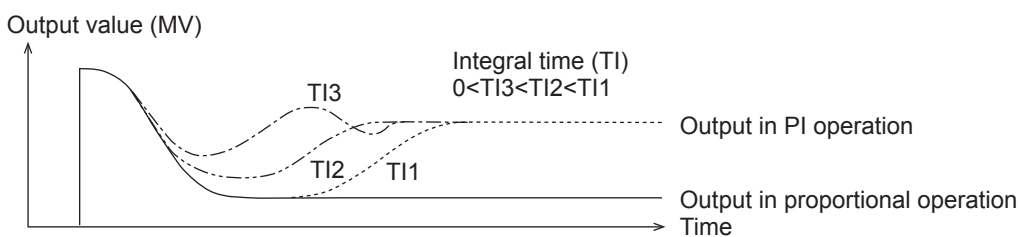
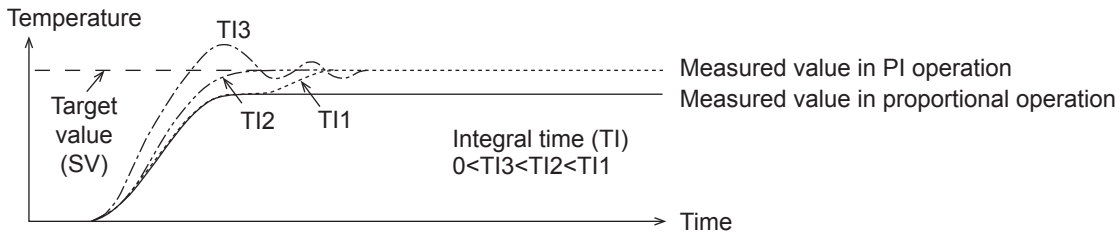

**Ex.**

PI operation in forward operation (cooling)

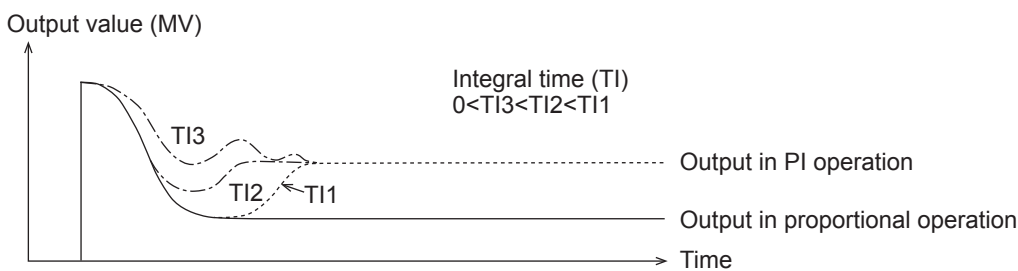
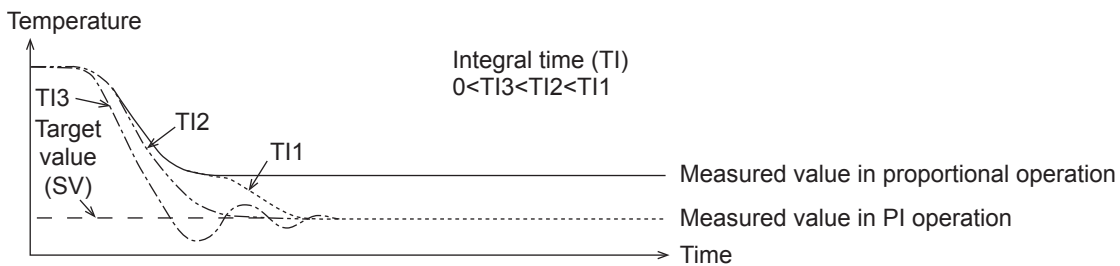

## Point

The integral operation changes the output so that the continuously generated deviation is eliminated. As a result, the remaining deviation generated in the proportional operation can be eliminated.

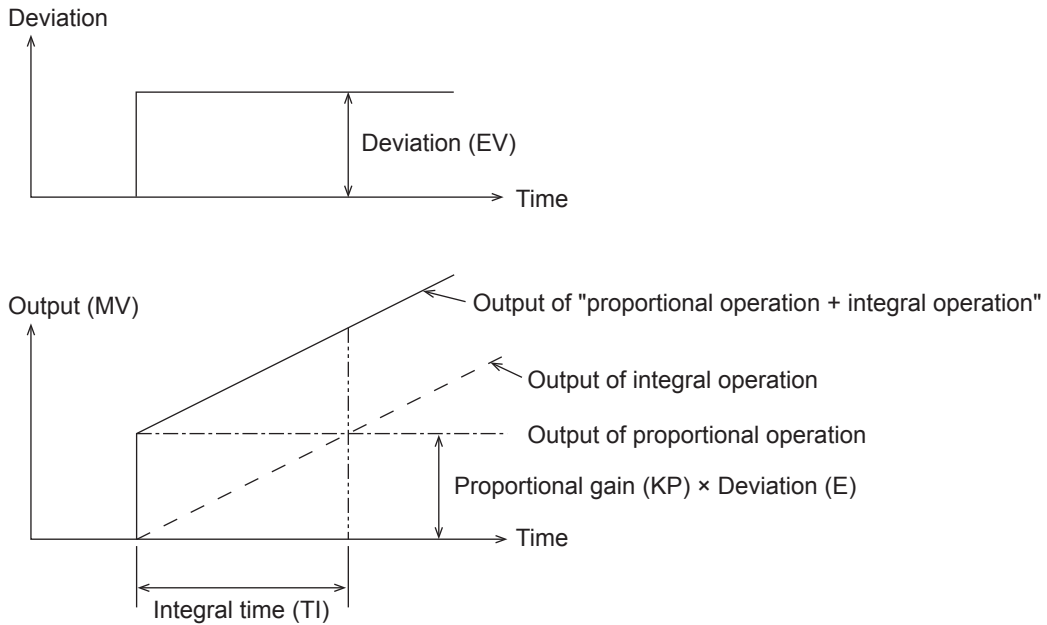

## Differential gain (s3)+5

The filter is applied to the output at the differential operation. Setting range: 0 to 100 (%)

Only the differential operation is affected by the differential gain (KD).

- When the differential gain (KD) is small, the output is immediately given with regard to changes in the measured value (PV) caused by disturbance, etc.
- When the differential gain (KD) is large, the output is given after a long time with respect to changes in the measured value (PV) caused by disturbance, etc.

## Point

Set the differential gain (KD) to "0", and then adjust the operation using the input filter ( $\alpha$ ). If the output response is too close to the disturbance, increase the differential gain (KD).

## Differential time (s3)+6

Use the differential time (TD) to respond sensitively to fluctuations in the measured value (PV) caused by disturbance, etc. and to minimize the fluctuations. Setting range: 0 to 32767 ( $\times 10$  ms)

- When the differential time (TD) is large, it prevent large fluctuation in the control target caused by disturbance, etc.
- It is not always necessary to use the differential time (TD) (when disturbance is small, for example).

Deviation

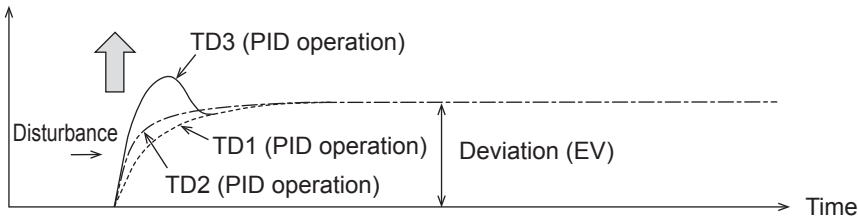

Output value (MV)

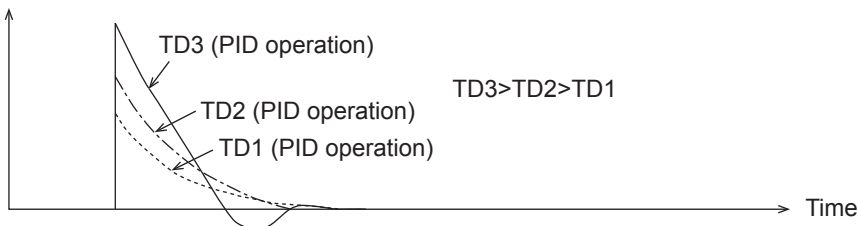

**Ex.**

PID operation in backward operation (heating)

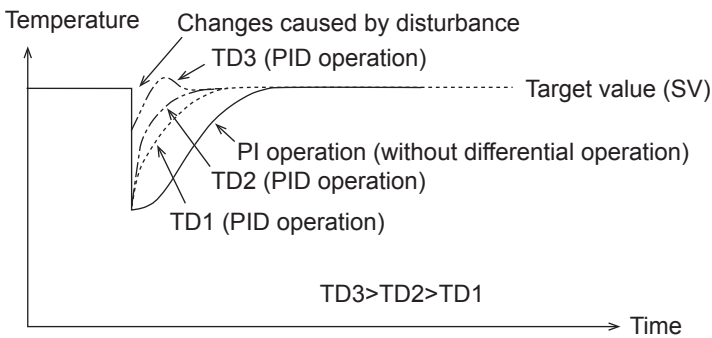

Output value (MV)

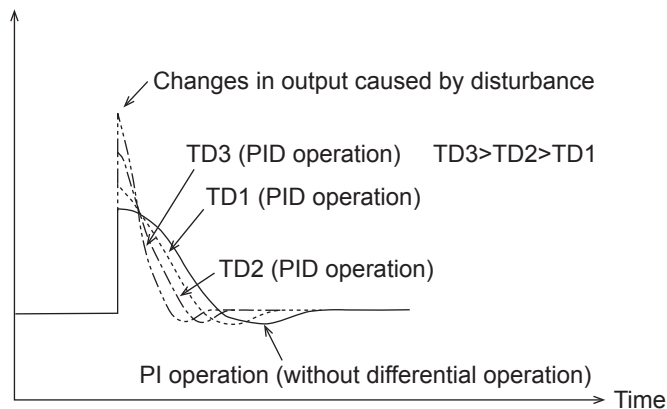

Ex.

PID operation in forward operation (cooling)

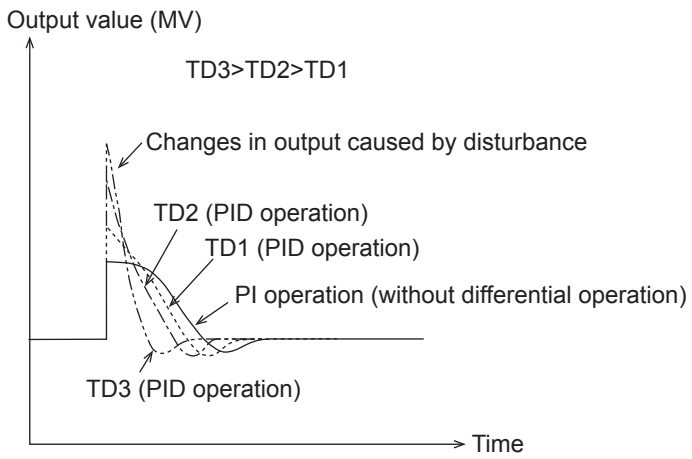
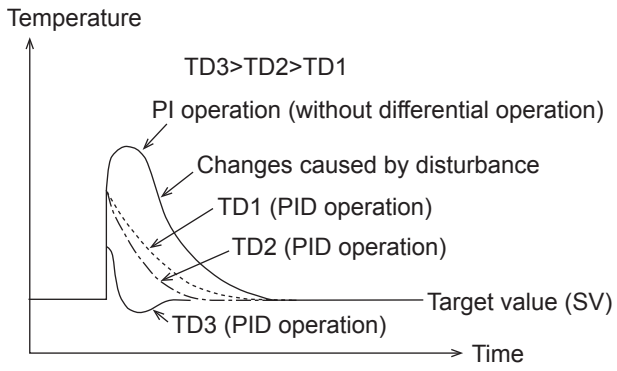

## Alarm output (s3)+24

If the input variation and the output variation specified with (s3) +20 to (s3) +23 are exceeded, each bit of (s3) +24 turns ON as a warning output.

Item	Description	Remarks	
Alarm output	(s3)+24: b0	OFF: Input variation (incremental) is not exceeded. ON: Input variation (incremental) is exceeded.	It is valid when operation setting (ACT) (b1 of (s3)+1) is "1".
	(s3)+24: b1	OFF: Input variation (decremental) is not exceeded. ON: Input variation (decremental) is exceeded.	
Alarm output	(s3)+24: b2	OFF: Output variation (incremental) is not exceeded. ON: Output variation (incremental) is exceeded.	It is valid when operation setting (ACT) (b2 of (s3)+1) is "1".
	(s3)+24: b3	OFF: Output variation (decremental) is not exceeded. ON: Output variation (decremental) is exceeded.	

### ■ In the case of input variation

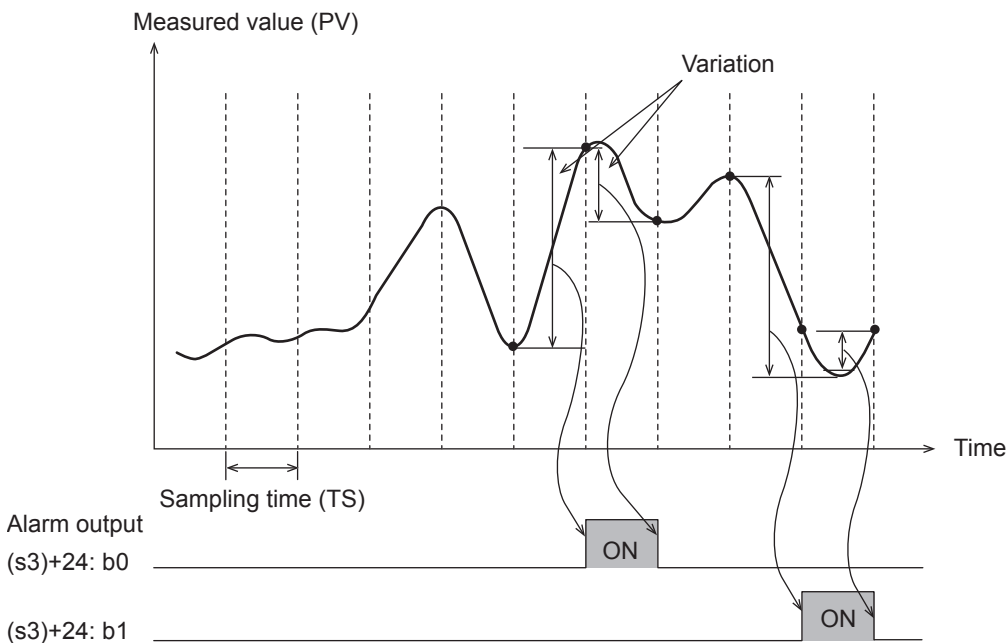

### ■ In the case of output variation

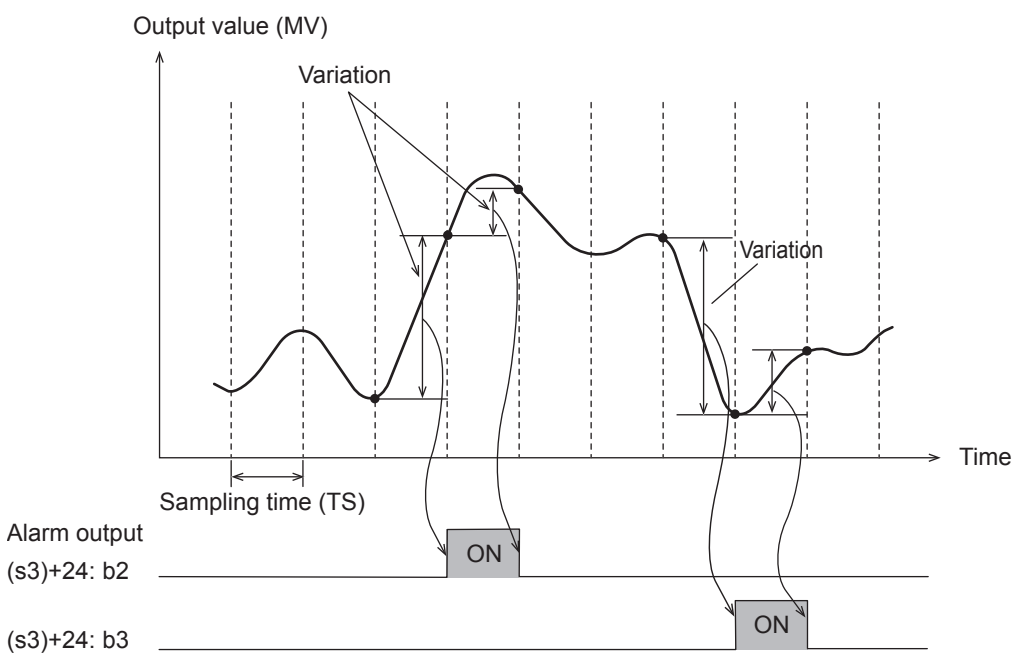

# Auto-tuning

This section describes the auto-tuning function of PID instruction.

The auto-tuning function will automatically set the important constants, such as the proportional gain and the integral time, to ensure optimum PID control. There are two auto-tuning methods: limit cycle method and step response method.

## Limit cycle method

For acquiring satisfactory control results in PID control, it is necessary to obtain the optimal value of each constant (parameter) suitable to the control target. This paragraph explains the limit cycle method to obtain the amplitude (a) and vibration cycle ( $\tau$ ,  $\tau_{on}$ ) of the input value, and then calculate the proportional gain (KP), integral time (TI) and differential time (TD) based on the expressions shown in the table below.

What is the limit cycle method changes in the input value in two-position control (in which the output Upper Limit Value (ULV) and output Lower Limit Value (LLV) are switched according to the deviation) are measured, and then three constants in the PID control are obtained.

### ■How to obtain three constants in PID control (Reference)

- Operation characteristics and three constants

Control type	Proportional gain (KP) [%]	Integral time (TI) [ $\times 100$ ms]	Differential time (TD) [ $\times 10$ ms]
Only proportional control (P operation)	$\frac{1}{a}(\text{ULV}-\text{LLV})\times 100$	—	—
PI control (PI operation)	$\frac{0.9}{a}(\text{ULV}-\text{LLV})\times 100$	$33\times\tau_{on}\left(1-\frac{\tau_{on}}{\tau}\right)$	—
PID control (PID operation)	$\frac{1.2}{a}(\text{ULV}-\text{LLV})\times 100$	$20\times\tau_{on}\left(1-\frac{\tau_{on}}{\tau}\right)$	$50\times\tau_{on}\left(1-\frac{\tau_{on}}{\tau}\right)$

- Operation characteristics (in an example of backward operation)

During the " $\tau W$ " period after the tuning cycle is finished, the output value (MV) is held at the output Lower Limit Value (LLV), and then normal PID control is started. The value " $\tau W$ " can be obtained by the expression " $\tau W = (50 + KW)/100 \times (\tau - \tau_{on})$ ", and the wait setting parameter " $KW$ " can be set in the parameter (s3)+28. (Setting range:  $KW = -50$  to  $+32717$  [%]) (When the abnormal range is specified, " $\tau W$ " is handled as "0")

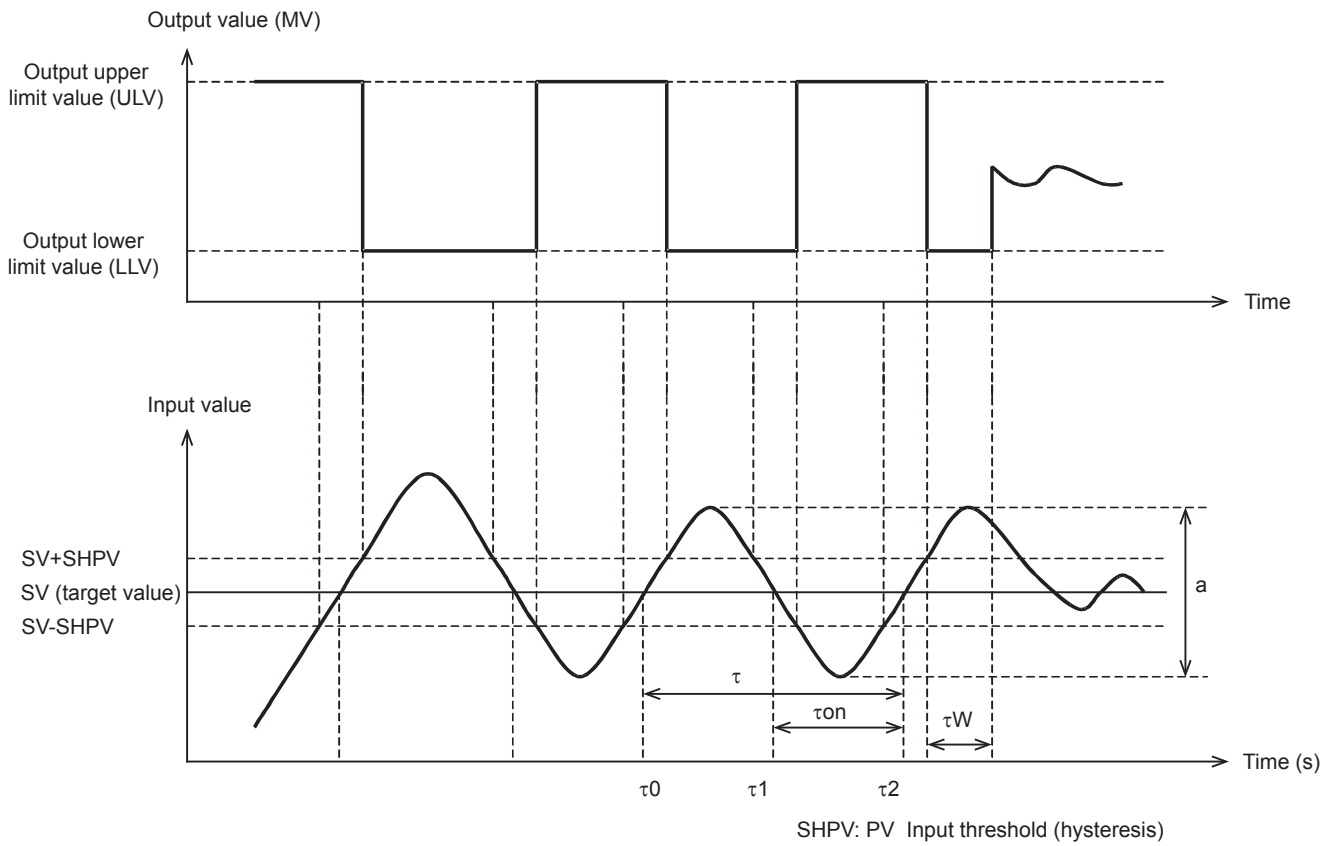

## ■Parameters set in limit cycle method

The parameters specified in the limit cycle method are shown below.

Parameter	Setting position
Proportional gain (KP)	(s3)+3
Integral time (TI)	(s3)+4
Differential time (TD)	(s3)+6

## ■Auto-tuning procedure

### 1. Set forward or backward operation

Set the operation direction flag (b0) in the operation setting parameter (ACT) (s3)+1.

### 2. Select the auto-tuning method (limit cycle method)

Set the auto-tuning method to ON (b6) in the operation setting parameter (ACT) (s3)+1. (When bit 6 is set to OFF, the step response method is selected.)

### 3. Set the auto-tuning execution flag to ON

Set the auto-tuning execution flag to ON (b4) in the operation setting parameter (ACT) (s3)+1.

### 4. Set the input filter

Set the input filter in the operation setting parameter (ACT) (s3)+2.

### 5. Set the sampling time

Set the sampling time (s3).

### 6. Set the Upper Limit Value (ULV)

Set the Upper Limit Value (ULV) of the output value (MV) in the operation setting parameter (ACT) (s3)+26.

### 7. Set the Lower Limit Value (LLV)

Set the Lower Limit Value (LLV) of the output value (MV) in the operation setting parameter (ACT) (s3)+27.

### 8. Set the threshold (hysteresis) (SHPV)

Set the threshold (hysteresis) width (SHPV) in the operation setting parameter (ACT) (s3)+25.

### 9. Set the target value (SV)

Set the target value (SV) in (s1) of the PID instruction.

### 10. Set the PID instruction command input ON to start auto-tuning

Auto-tuning is executed according to the measured value (PV).

When auto-tuning is completed, the auto-tuning flags (b4 and b6) turn OFF in the operation setting parameter (ACT): (s3)+1.



## Step response method

For acquiring satisfactory control results during PID control, it is necessary to obtain the optimal value of each constant (parameter) suitable for the control target. This paragraph explains the step response method to obtain three constants in the PID control (proportional gain (KP), integral time (TI) and differential time (TD)).

In this method, by giving stepped output from 0 to 100 % to the control system, three constants in the PID control are obtained from the operation characteristics (maximum ramp (R) and dead time (L)) and the input value variation. The stepped output may be obtained from 0 to 75 % or from 0 to 50 %.

### How to obtain three constants in PID control (Reference)

- Operation characteristics and three constants

Control type	Proportional gain (KP) [%]	Integral time (TI) [ $\times 100$ ms]	Differential time (TD) [ $\times 10$ ms]
Only proportional control (P operation)	$\frac{1}{RL} \times \text{Output value (MV)} \times 100$	—	—
PI control (PI operation)	$\frac{0.9}{RL} \times \text{Output value (MV)} \times 100$	33L	—
PID control (PID operation)	$\frac{1.2}{RL} \times \text{Output value (MV)} \times 100$	20L	50L

- Operation characteristics

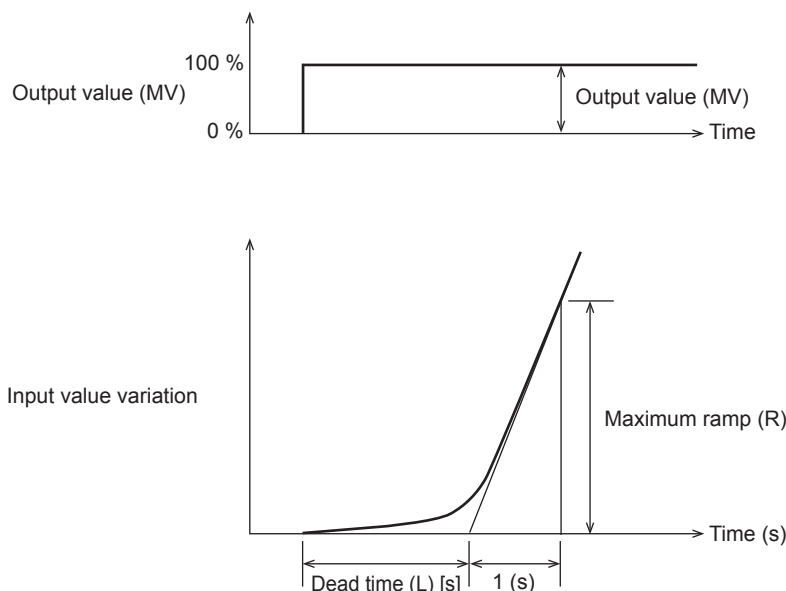

### Parameters set in step response method

The parameters specified in the step response method are shown below.

Parameter	Setting position
Operation setting (ACT)	(s3)+1: b0 (operation direction)
Proportional gain (KP)	(s3)+3
Integral time (TI)	(s3)+4
Differential time (TD)	(s3)+6

## ■Auto-tuning procedure

**1.** Transferring the output value for auto-tuning to the output value (d)

Set the output value for auto-tuning to the maximum available output value multiplied by 0.5 to 1 for the output equipment.

**2.** Setting the parameter (s3), target value (SV), etc. that cannot be set in autotuning according to the system

**3.** Set the auto-tuning execution flag to ON

Set the auto-tuning execution flag to ON (b4) in the operation setting parameter (ACT) (s3)+1.

**4.** Set the PID instruction command input ON to start auto-tuning

Auto-tuning is executed according to the measured value (PV).

When auto-tuning is completed, the auto-tuning flag (b4) turns OFF in the operation setting parameter (ACT): (s3)+1.

### Point

---

Start auto-tuning while the system is stable.

If the system is unstable when auto-tuning is started, auto-tuning may not be executed normally.

---

## ■Cautions on auto-tuning setting

Note that auto-tuning may not be executed normally if the cautions described below are not followed

- Difference between the target value (SV) and the measured value (PV)

If the difference between the target value (SV) and the measured value (PV) is less than 75 when autotuning is started, auto-tuning is not executed normally. Accordingly, if the difference is less than 75, set the target value for auto-tuning. Set the target value again when auto-tuning is completed.

- Sampling time (TS)

Make sure the sampling time is set for auto-tuning to 1 second (1000 ms) or more. It is recommended that the sampling time is set to that it is considerably longer than the output change cycle.

## ■Cautions on auto-tuning execution

- Program countermeasures when the input value (PV) does not change

When the input value (PV) does not change normally due to factors such as wire breakage in an analog input line, auto-tuning is not finished. Detect and avoid such occurrences by introducing a sequence to monitor the input value or the elapsed time from the start of auto-tuning.

# Examples of program

## System configuration example

An example of the system configuration when the PID control function is used is shown below.

### System configuration

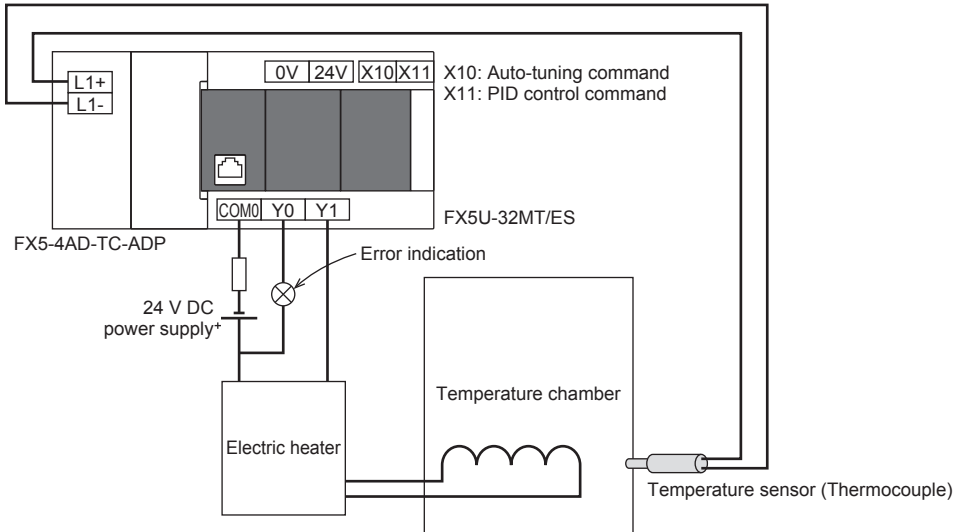

### Operation of the electric heater

The operation of the electric heater (Y1) is as follows.

- During PID control

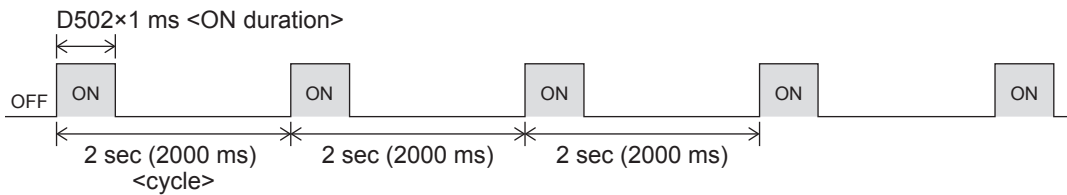

- During auto-tuning (In case of 90% of maximum output)

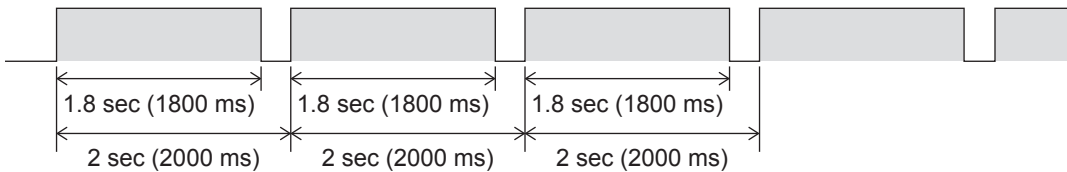

### Program examples

Program example	Description	Reference
Program example 1	This is an example of the sample program for PID control.	Page 586
Program example 2	This is an example of the sample program for auto tuning (limit cycle method).	Page 588
Program example 3	This is an example of the sample program for auto tuning (step response method).	Page 590
Program example 4	This is an example of the sample program for auto tuning (limit cycle method) + PID control.	Page 592
Program example 5	This is an example of the sample program for auto tuning (step response method) + PID control.	Page 594

## Program example 1

This is an example of the sample program for PID control.

### ■Use device

The content of the devices used for the program is as follows.

Item		Device	Setting value			
			During auto-tuning	During PID control		
Target value (SV) <sup>*1</sup>		(s1)	D500	Not used	500 (50.0°C)	
Measured value (PV) <sup>*1</sup>		(s2)	SD6300 <sup>*2</sup>	Not used	According to input value	
Parameter	Sampling time (TS) <sup>*1</sup>	(s3)	D510	Not used	500 (500 ms)	
	Operation setting (ACT)	Operation direction <sup>*1</sup>	(s3)+1 b0	D511.0	Not used	1 (Backward operation)
		Input variation alarm	(s3)+1 b1	D511.1	Not used	0 (Alarm is not provided)
		Output variation alarm	(s3)+1 b2	D511.2	Not used	0 (Alarm is not provided)
		Auto-tuning	(s3)+1 b4	D511.4	Not used	0 (AT is not provided)
		Upper and lower limits of output value	(s3)+1 b5	D511.5	Not used	1 (Setting is provided)
		Select auto-tuning mode	(s3)+1 b6	D511.6	Not used	Not used
		Overshoot suppression setting	(s3)+1 b7	D511.7	Not used	1 (Used)
	Hunting suppression setting	(s3)+1 b8	D511.8	Not used	Not used	
	Input filter constant ( $\alpha$ )	(s3)+2	D512	Not used	0 (Input filter is not provided)	
	Proportional gain (KP) <sup>*1</sup>	(s3)+3	D513	Not used	3000 (3000 %)	
	Integral time (TI) <sup>*1</sup>	(s3)+4	D514	Not used	2000 (2000 × 100 ms)	
	Differential gain (KD)	(s3)+5	D515	Not used	0 (Differential gain is not provided)	
	Differential time (TD) <sup>*1</sup>	(s3)+6	D516	Not used	5000 (5000 × 10 ms)	
	Input variation (incremental) alarm set value	(s3)+20	D530	Not used	Not used	
	Input variation (decremental) alarm set value	(s3)+21	D531	Not used	Not used	
	Output variation (incremental) alarm set value Output upper limit set value	(s3)+22	D532	Not used	2000 (2 second)	
	Output variation (decremental) alarm set value Output lower limit set value	(s3)+23	D533	Not used	0 (0 second)	
	Alarm output	Input variation (incremental) is exceeded	(s3)+24 b0	D534.0	Not used	Not used
		Input variation (decremental) is exceeded	(s3)+24 b1	D534.1	Not used	Not used
Output variation (incremental) is exceeded		(s3)+24 b2	D534.2	Not used	Not used	
Output variation (decremental) is exceeded		(s3)+24 b3	D534.3	Not used	Not used	
PV value threshold (hysteresis) width (SHPV)	(s3)+25	D535	—	—		
Output value upper limit (ULV)	(s3)+26	D536	—	—		
Output value lower limit (LLV)	(s3)+27	D537	—	—		
Wait setting from end of tuning cycle to start of PID control (KW)	(s3)+28	D538	—	—		
Output value (MV) <sup>*1</sup>		(d)	D502	Not used	According to operation	

—: This is an item not occupied.

\*1 The setting is always necessary.

\*2 When CH1 is used.

■ Program

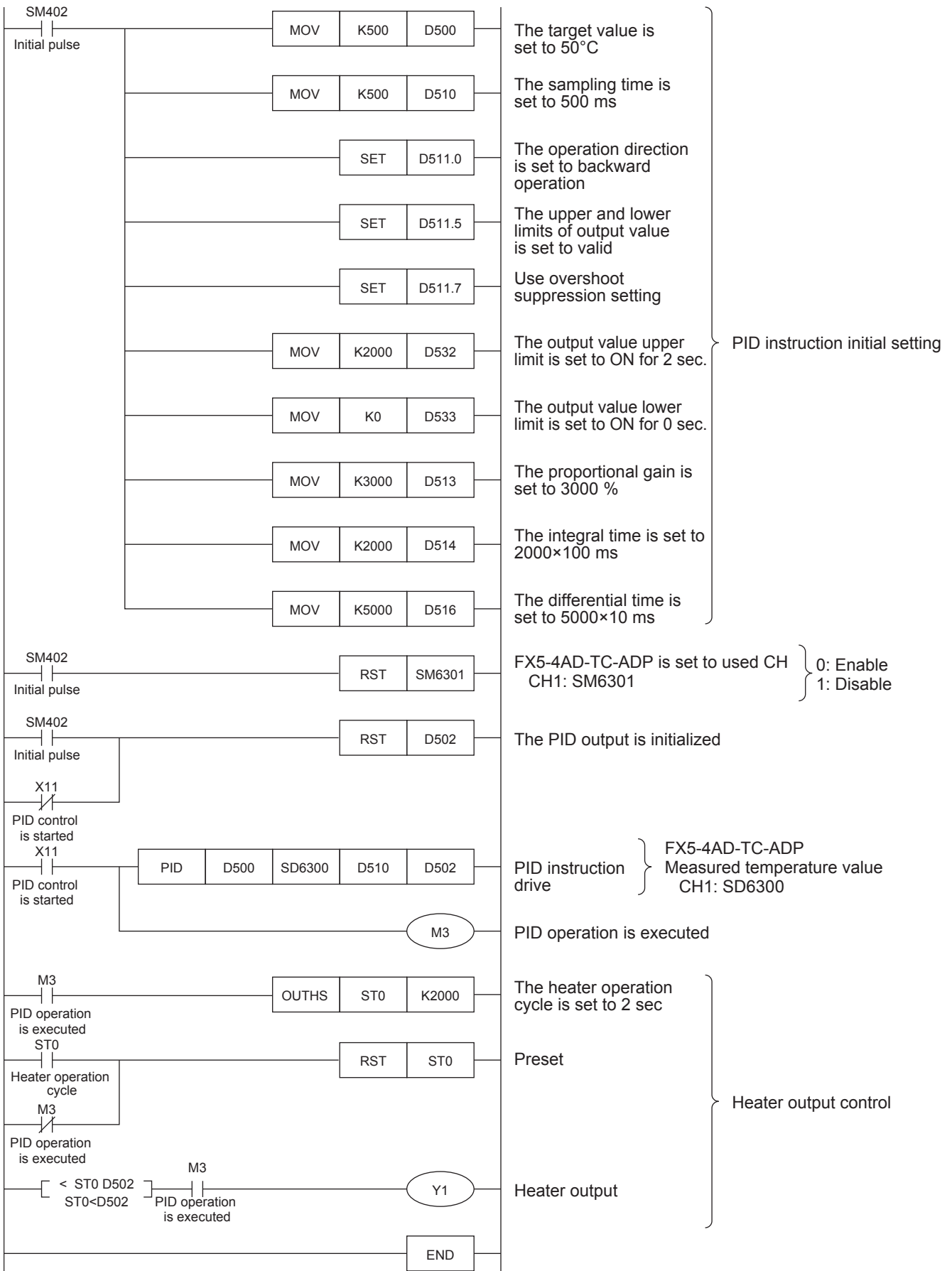

## Program example 2

This is an example of the sample program for auto tuning (limit cycle method).

### ■Use device

The content of the devices used for the program is as follows.

Item		Device	Setting value			
			During auto-tuning	During PID control		
Target value (SV) <sup>*1</sup>		(s1)	D500	500 (50.0°C)	Not used	
Measured value (PV) <sup>*1</sup>		(s2)	SD6300 <sup>*2</sup>	According to input value	Not used	
Parameter	Sampling time (TS) <sup>*1</sup>	(s3)	D510	500 (500 ms)	Not used	
	Operation setting (ACT)	Operation direction <sup>*1</sup>	(s3)+1 b0	D511.0	1 (Backward operation)	Not used
		Input variation alarm	(s3)+1 b1	D511.1	0 (Alarm is not provided)	Not used
		Output variation alarm	(s3)+1 b2	D511.2	0 (Alarm is not provided)	Not used
		Auto-tuning	(s3)+1 b4	D511.4	1 (AT is provided)	Not used
		Upper and lower limits of output value	(s3)+1 b5	D511.5	0 (Setting is not provided)	Not used
		Select auto-tuning mode	(s3)+1 b6	D511.6	1 (Limit cycle method)	Not used
		Overshoot suppression setting	(s3)+1 b7	D511.7	Not used	Not used
		Hunting suppression setting	(s3)+1 b8	D511.8	Not used	Not used
	Input filter constant ( $\alpha$ )	(s3)+2	D512	0 (Input filter is not provided)	Not used	
	Proportional gain (KP) <sup>*1</sup>	(s3)+3	D513	According to auto-tuning result	Not used	
	Integral time (TI) <sup>*1</sup>	(s3)+4	D514	According to auto-tuning result	Not used	
	Differential gain (KD)	(s3)+5	D515	0 (Differential gain is not provided)	Not used	
	Differential time (TD) <sup>*1</sup>	(s3)+6	D516	According to auto-tuning result	Not used	
	Input variation (incremental) alarm set value	(s3)+20	D530	Not used	Not used	
	Input variation (decremental) alarm set value	(s3)+21	D531	Not used	Not used	
	Output variation (incremental) alarm set value Output upper limit set value	(s3)+22	D532	Not used	Not used	
	Output variation (decremental) alarm set value Output lower limit set value	(s3)+23	D533	Not used	Not used	
	Alarm output	Input variation (incremental) is exceeded	(s3)+24 b0	D534.0	Not used	Not used
		Input variation (decremental) is exceeded	(s3)+24 b1	D534.1	Not used	Not used
		Output variation (incremental) is exceeded	(s3)+24 b2	D534.2	Not used	Not used
		Output variation (decremental) is exceeded	(s3)+24 b3	D534.3	Not used	Not used
	PV value threshold (hysteresis) width (SHPV)	(s3)+25	D535	50 (5.0°C)	Not used	
	Output value upper limit (ULV)	(s3)+26	D536	2000 (2 second)	Not used	
	Output value lower limit (LLV)	(s3)+27	D537	0 (0 second)	Not used	
Wait setting from end of tuning cycle to start of PID control (KW)	(s3)+28	D538	-50 (Wait is not provided)	Not used		
Output value (MV) <sup>*1</sup>		(d)	D502	According to operation	Not used	

—: This is an item not occupied.

\*1 The setting is always necessary.

\*2 When CH1 is used.

■ Program

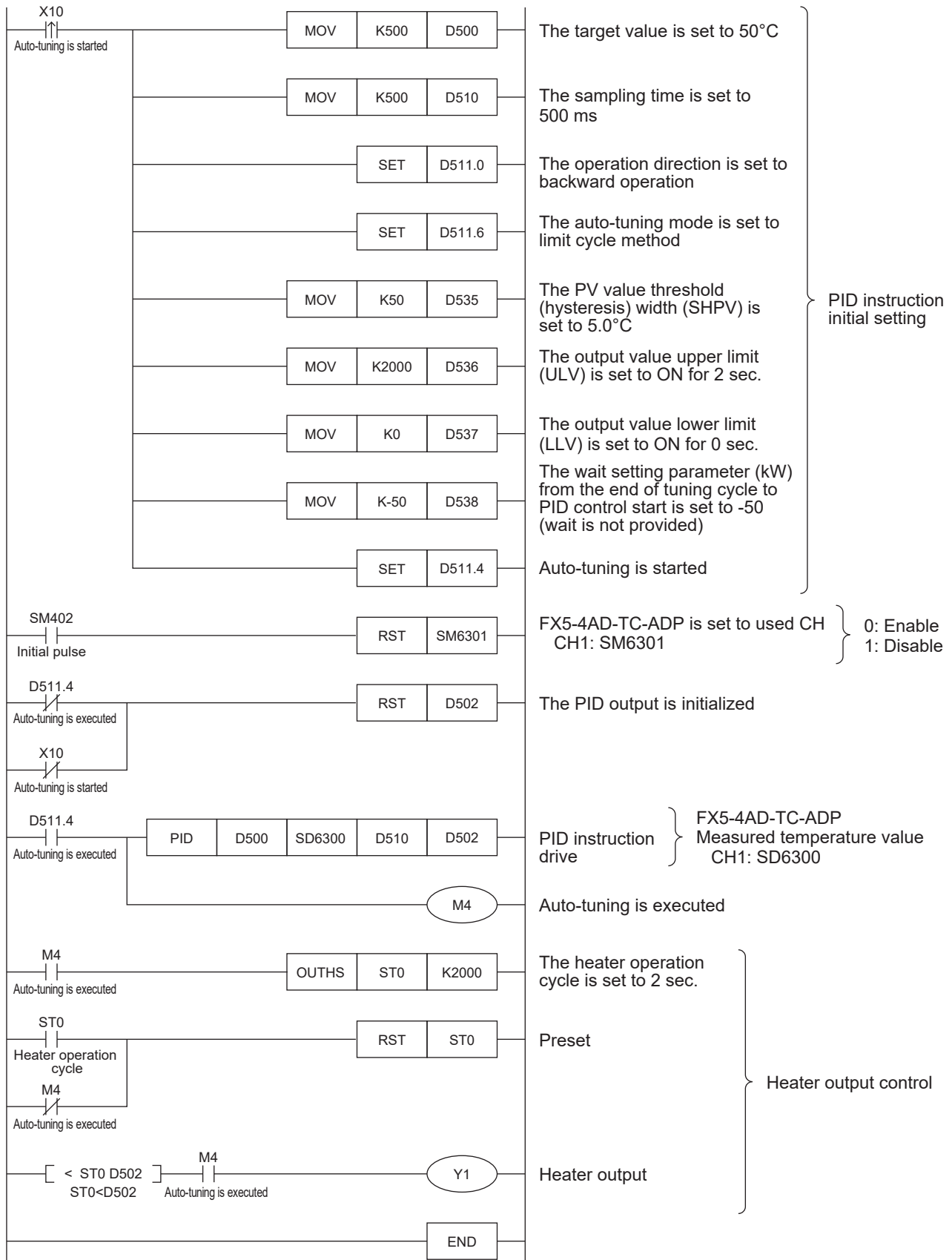

## Program example 3

This is an example of the sample program for auto tuning (step response method).

### ■Use device

The content of the devices used for the program is as follows.

Item		Device	Setting value			
			During auto-tuning	During PID control		
Target value (SV) <sup>*1</sup>		(s1)	D500	500 (50.0°C)	Not used	
Measured value (PV) <sup>*1</sup>		(s2)	SD6300 <sup>*2</sup>	According to input value	Not used	
Parameter	Sampling time (TS) <sup>*1</sup>	(s3)	D510	1000 (1000 ms)	Not used	
	Operation setting (ACT)	Operation direction <sup>*1</sup>	(s3)+1 b0	D511.0	According to auto-tuning result	Not used
		Input variation alarm	(s3)+1 b1	D511.1	0 (Alarm is not provided)	Not used
		Output variation alarm	(s3)+1 b2	D511.2	0 (Alarm is not provided)	Not used
		Auto-tuning	(s3)+1 b4	D511.4	1 (AT is provided)	Not used
		Upper and lower limits of output value	(s3)+1 b5	D511.5	0 (Setting is not provided)	Not used
		Select auto-tuning mode	(s3)+1 b6	D511.6	0 (Step response method)	Not used
		Overshoot suppression setting	(s3)+1 b7	D511.7	Not used	Not used
	Hunting suppression setting	(s3)+1 b8	D511.8	1 (Timeout time is valid)	Not used	
	Input filter constant ( $\alpha$ )	(s3)+2	D512	0 (Input filter is not provided)	Not used	
	Proportional gain (KP) <sup>*1</sup>	(s3)+3	D513	According to auto-tuning result	Not used	
	Integral time (TI) <sup>*1</sup>	(s3)+4	D514	According to auto-tuning result	Not used	
	Differential gain (KD)	(s3)+5	D515	0 (Differential gain is not provided)	Not used	
	Differential time (TD) <sup>*1</sup>	(s3)+6	D516	According to auto-tuning result	Not used	
	Input variation (incremental) alarm set value	(s3)+20	D530	Not used	Not used	
	Input variation (decremental) alarm set value	(s3)+21	D531	Not used	Not used	
	Output variation (incremental) alarm set value	(s3)+22	D532	Not used	Not used	
	Output upper limit set value					
	Output variation (decremental) alarm set value	(s3)+23	D533	Not used	Not used	
	Output lower limit set value					
	Alarm output	Input variation (incremental) is exceeded	(s3)+24 b0	D534.0	Not used	Not used
		Input variation (decremental) is exceeded	(s3)+24 b1	D534.1	Not used	Not used
		Output variation (incremental) is exceeded	(s3)+24 b2	D534.2	Not used	Not used
Output variation (decremental) is exceeded		(s3)+24 b3	D534.3	Not used	Not used	
Timeout time setting value after maximum ramp (R) detection	(s3)+25	D535	10 (10 seconds)	Not used		
Used by system	(s3)+26	D536	Not used	Not used		
Used by system	(s3)+27	D537	Not used	Not used		
Wait setting from end of tuning cycle to start of PID control (KW)	(s3)+28	D538	—	—		
Output value (MV) <sup>*1</sup>		(d)	D502	1800 (1.8 second)	Not used	

—: This is an item not occupied.

\*1 The setting is always necessary.

\*2 When CH1 is used.



## Program

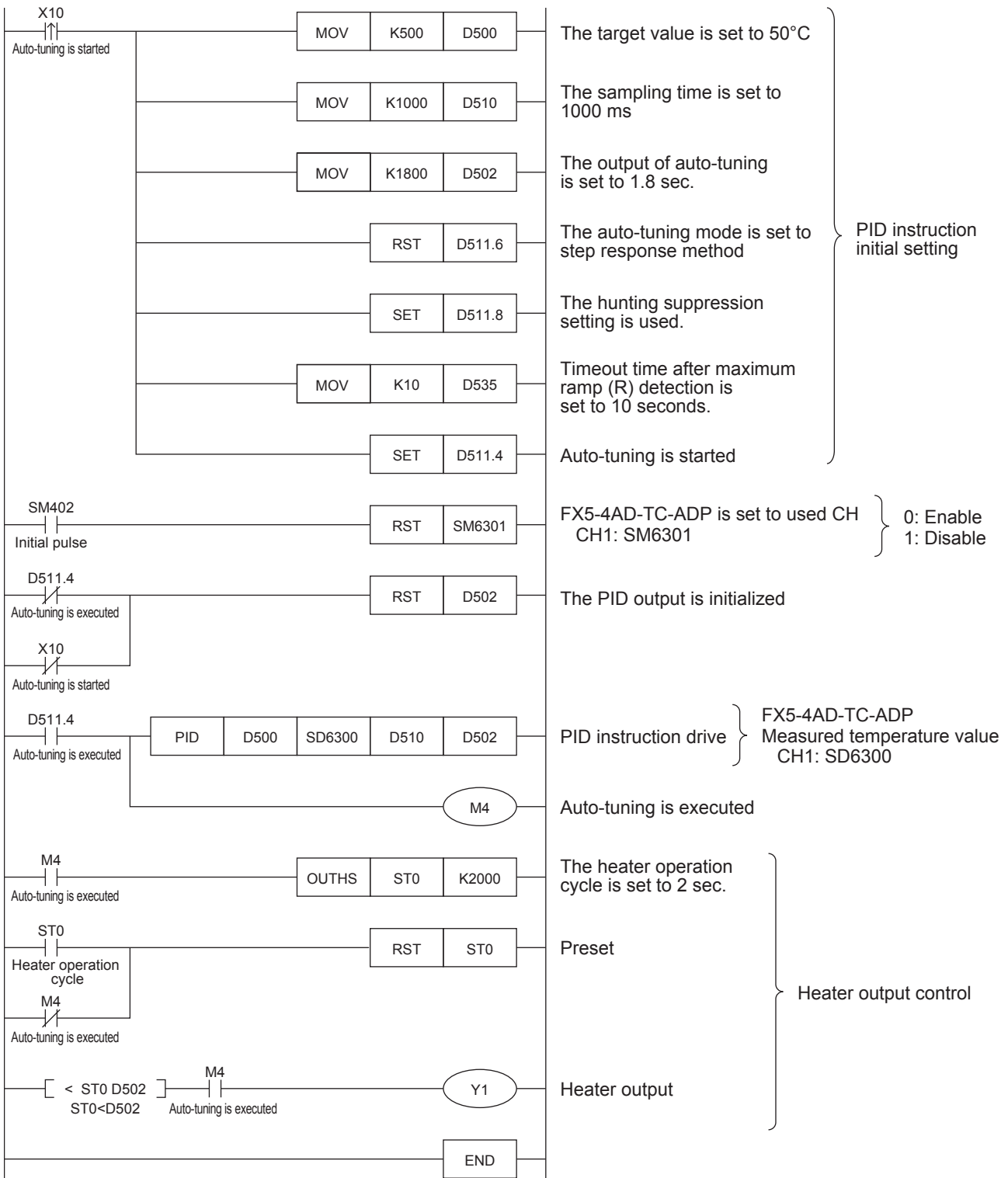

## Program example 4

This is an example of the sample program for auto tuning (limit cycle method) + PID control.

### ■Use device

The content of the devices used for the program is as follows.

Item		Device	Setting value			
			During auto-tuning	During PID control		
Target value (SV) <sup>*1</sup>		(s1)	D500	500 (50.0°C)	500 (50.0°C)	
Measured value (PV) <sup>*1</sup>		(s2)	SD6300 <sup>*2</sup>	According to input value	According to input value	
Parameter	Sampling time (TS) <sup>*1</sup>	(s3)	D510	500 (500 ms)	500 (500 ms)	
	Operation setting (ACT)	Operation direction <sup>*1</sup>	(s3)+1 b0	D511.0	1 (Backward operation)	1 (Backward operation)
		Input variation alarm	(s3)+1 b1	D511.1	0 (Alarm is not provided)	0 (Alarm is not provided)
		Output variation alarm	(s3)+1 b2	D511.2	0 (Alarm is not provided)	0 (Alarm is not provided)
		Auto-tuning	(s3)+1 b4	D511.4	1 (AT is provided)	1 (AT is provided)
		Upper and lower limits of output value	(s3)+1 b5	D511.5	1 (Setting is provided)	1 (Setting is provided)
		Select auto-tuning mode	(s3)+1 b6	D511.6	1 (Limit cycle method)	Not used
		Overshoot suppression setting	(s3)+1 b7	D511.7	Not used	1 (Used)
		Hunting suppression setting	(s3)+1 b8	D511.8	Not used	Not used
	Input filter constant ( $\alpha$ )	(s3)+2	D512	0 (Input filter is not provided)	0 (Input filter is not provided)	
	Proportional gain (KP) <sup>*1</sup>	(s3)+3	D513	According to auto-tuning result	According to auto-tuning result	
	Integral time (TI) <sup>*1</sup>	(s3)+4	D514	According to auto-tuning result	According to auto-tuning result	
	Differential gain (KD)	(s3)+5	D515	0 (Differential gain is not provided)	0 (Differential gain is not provided)	
	Differential time (TD) <sup>*1</sup>	(s3)+6	D516	According to auto-tuning result	According to auto-tuning result	
	Input variation (incremental) alarm set value	(s3)+20	D530	Not used	Not used	
	Input variation (decremental) alarm set value	(s3)+21	D531	Not used	Not used	
	Output variation (incremental) alarm set value Output upper limit set value	(s3)+22	D532	Not used	2000 (2 second)	
	Output variation (decremental) alarm set value Output lower limit set value	(s3)+23	D533	Not used	0 (0 second)	
	Alarm output	Input variation (incremental) is exceeded	(s3)+24 b0	D534.0	Not used	Not used
		Input variation (decremental) is exceeded	(s3)+24 b1	D534.1	Not used	Not used
		Output variation (incremental) is exceeded	(s3)+24 b2	D534.2	Not used	Not used
		Output variation (decremental) is exceeded	(s3)+24 b3	D534.3	Not used	Not used
	PV value threshold (hysteresis) width (SHPV)	(s3)+25	D535	50 (5.0°C)	Not used	
	Output value upper limit (ULV)	(s3)+26	D536	2000 (2 second)	Not used	
	Output value lower limit (LLV)	(s3)+27	D537	0 (0 second)	Not used	
	Wait setting from end of tuning cycle to start of PID control (KW)	(s3)+28	D538	-50 (Wait is not provided)	Not used	
	Output value (MV) <sup>*1</sup>		(d)	D502	According to operation	According to operation

—: This is an item not occupied.

\*1 The setting is always necessary.

\*2 When CH1 is used.

## Program

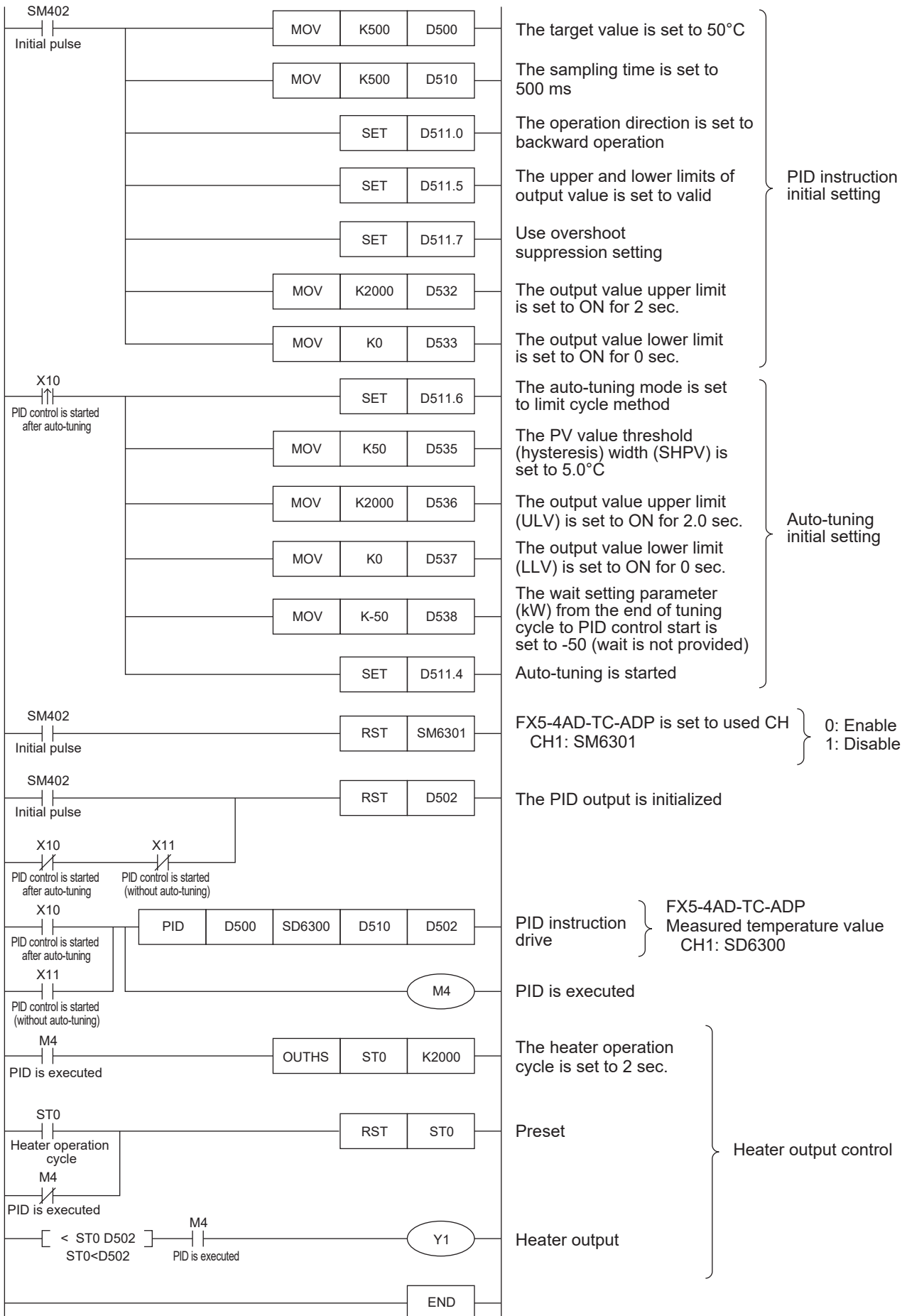

## Program example 5

This is an example of the sample program for auto tuning (step response method) + PID control.

### ■Use device

The content of the devices used for the program is as follows.

Item		Device	Setting value			
			During auto-tuning	During PID control		
Target value (SV) <sup>*1</sup>		(s1)	D500	500 (50.0°C)	500 (50.0°C)	
Measured value (PV) <sup>*1</sup>		(s2)	SD6300 <sup>*2</sup>	According to input value	According to input value	
Parameter	Sampling time (TS) <sup>*1</sup>	(s3)	D510	1000 (1000 ms)	500 (500 ms)	
	Operation setting (ACT)	Operation direction <sup>*1</sup>	(s3)+1 b0	D511.0	According to auto-tuning result	According to auto-tuning result
		Input variation alarm	(s3)+1 b1	D511.1	0 (Alarm is not provided)	0 (Alarm is not provided)
		Output variation alarm	(s3)+1 b2	D511.2	0 (Alarm is not provided)	0 (Alarm is not provided)
		Auto-tuning	(s3)+1 b4	D511.4	1 (AT is provided)	0 (AT is not provided)
		Upper and lower limits of output value	(s3)+1 b5	D511.5	1 (Setting is provided)	1 (Setting is provided)
		Select auto-tuning mode	(s3)+1 b6	D511.6	0 (Step response method)	Not used
		Overshoot suppression setting	(s3)+1 b7	D511.7	Not used	1 (Used)
		Hunting suppression setting	(s3)+1 b8	D511.8	1 (Timeout time is valid)	Not used
	Input filter constant ( $\alpha$ )	(s3)+2	D512	0 (Input filter is not provided)	0 (Input filter is not provided)	
	Proportional gain (KP) <sup>*1</sup>	(s3)+3	D513	According to auto-tuning result	According to auto-tuning result	
	Integral time (TI) <sup>*1</sup>	(s3)+4	D514	According to auto-tuning result	According to auto-tuning result	
	Differential gain (KD)	(s3)+5	D515	0 (Differential gain is not provided)	0 (Differential gain is not provided)	
	Differential time (TD) <sup>*1</sup>	(s3)+6	D516	According to auto-tuning result	According to auto-tuning result	
	Input variation (incremental) alarm set value	(s3)+20	D530	Not used	Not used	
	Input variation (decremental) alarm set value	(s3)+21	D531	Not used	Not used	
	Output variation (incremental) alarm set value Output upper limit set value	(s3)+22	D532	Not used	2000 (2 second)	
	Output variation (decremental) alarm set value Output lower limit set value	(s3)+23	D533	Not used	0 (0 second)	
	Alarm output	Input variation (incremental) is exceeded	(s3)+24 b0	D534.0	Not used	Not used
		Input variation (decremental) is exceeded	(s3)+24 b1	D534.1	Not used	Not used
Output variation (incremental) is exceeded		(s3)+24 b2	D534.2	Not used	Not used	
Output variation (decremental) is exceeded		(s3)+24 b3	D534.3	Not used	Not used	
Timeout time setting value after maximum ramp (R) detection	(s3)+25	D535	10 (10 seconds)	Not used		
Used by system	(s3)+26	D536	Not used	Not used		
Used by system	(s3)+27	D537	Not used	Not used		
Wait setting from end of tuning cycle to start of PID control (KW)	(s3)+28	D538	—	—		
Output value (MV) <sup>*1</sup>		(d)	D502	1800 (1.8 second)	According to operation	

—: This is an item not occupied.

\*1 The setting is always necessary.

\*2 When CH1 is used.

■ Program

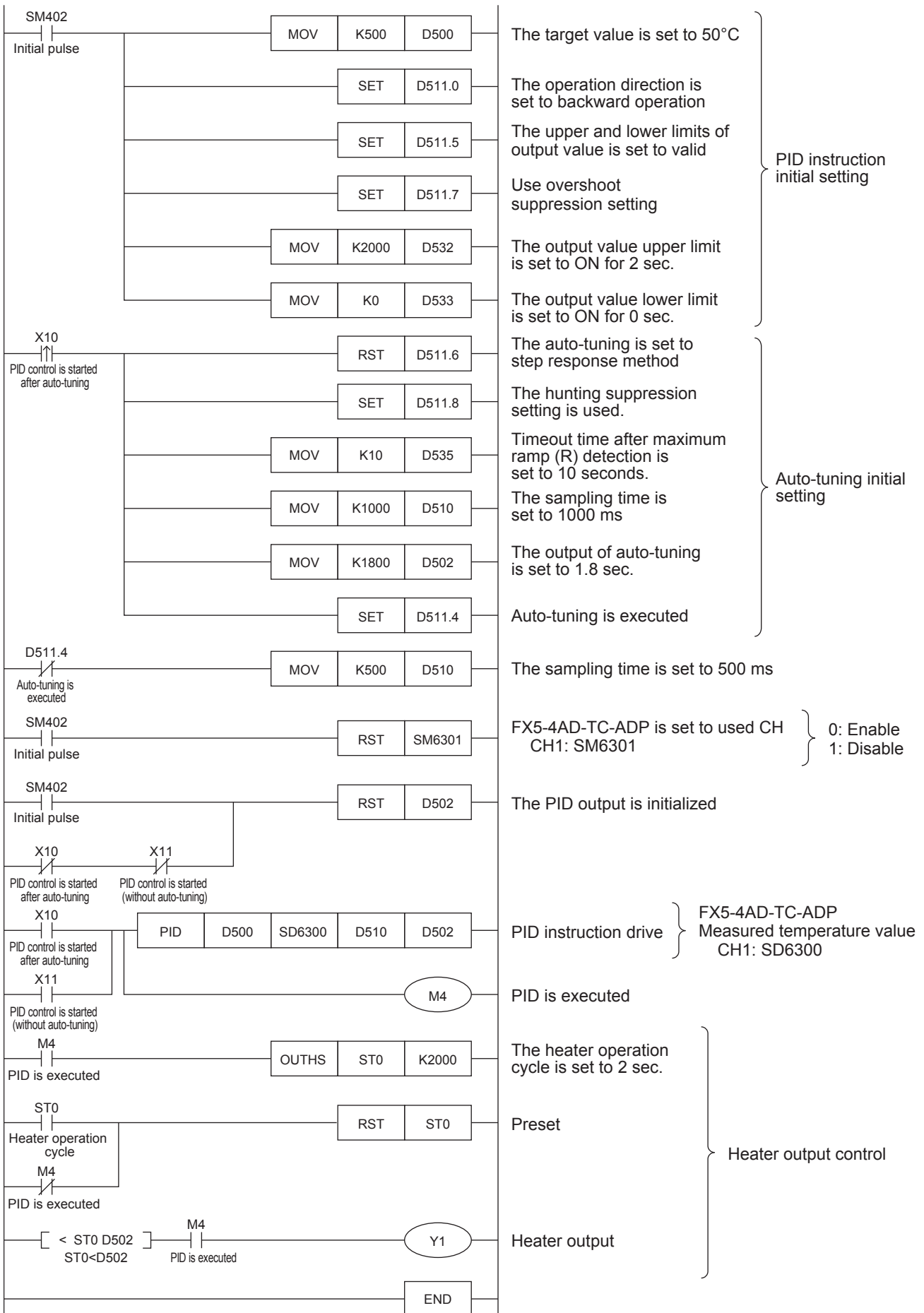

# Example of parameter adjustment and the effect on PID control operation

This section describes parameters that can be adjusted to improve the PID control result and the effect of the parameters.

## Improvement of control results

The following table shows the outline of the details to be improved and methods for improvement.

Details to be improved	Auto-Tuning	Contents
Overshoot suppression	Auto-tuning is executed	Use overshoot suppression setting.
	Auto-tuning is not executed	Use overshoot suppression setting.
		Increase the integral time and execute. Shorten the sampling time and execute.
Hunting suppression	Auto-tuning is executed	Use the hunting suppression setting.
		Set the sampling time to be the output period or more and execute.
		Increase the filter input value and execute.
	Auto-tuning is not executed	Decrease the proportional gain and execute. Increase the differential time and execute. Shorten the sampling time and execute.
Reduction of remaining deviation	—	Increase the filter input value and execute.

### ■Overshoot suppression (When auto-tuning is executed)

When the step response method and the PID control are executed continuously and the following results are obtained, use the overshoot suppression setting (turn ON b7 of (s3)+1). The overshoot amount may be suppressed.

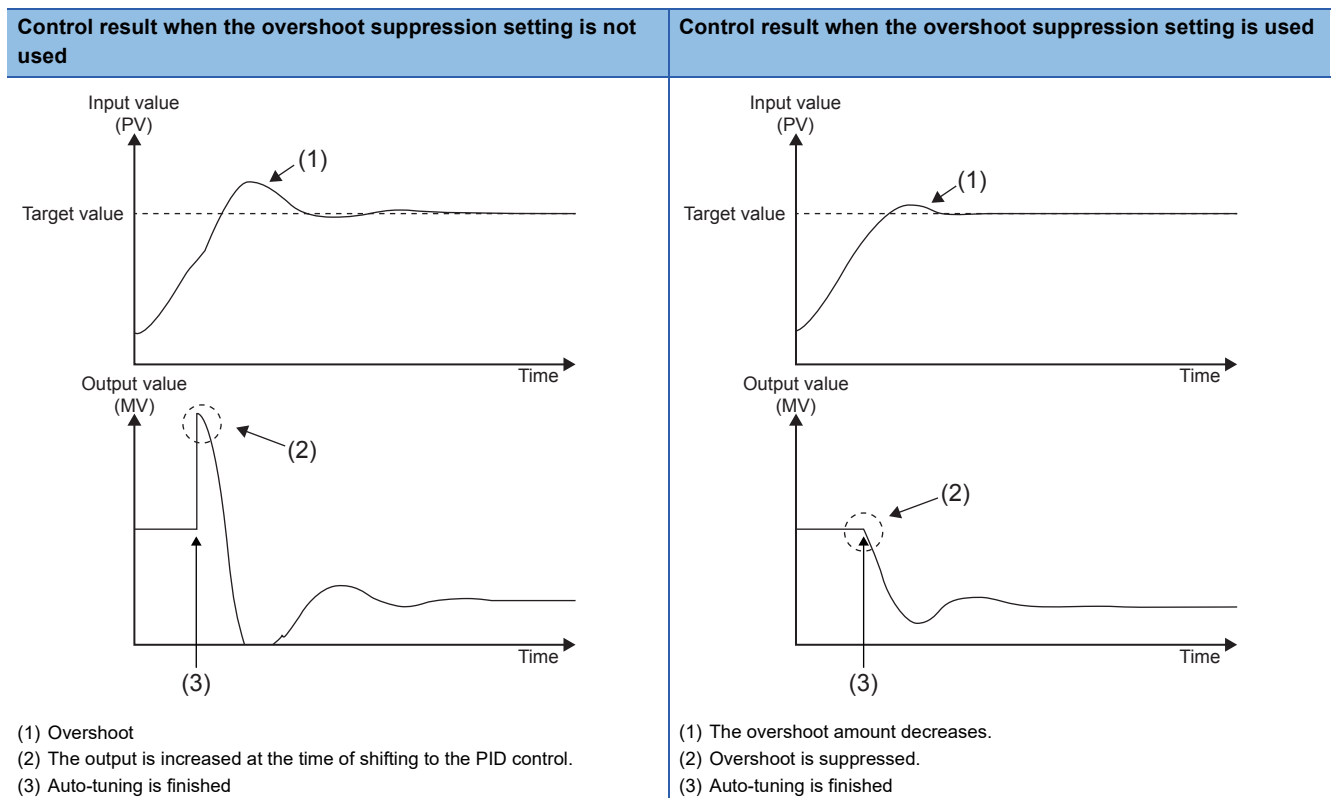

### ■Overshoot suppression (When auto-tuning is not executed)

When the PID control is executed and a large initial output causes overshoot, use the overshoot suppression setting (b7 of (s3)+1 turns ON). The overshoot amount may be suppressed.

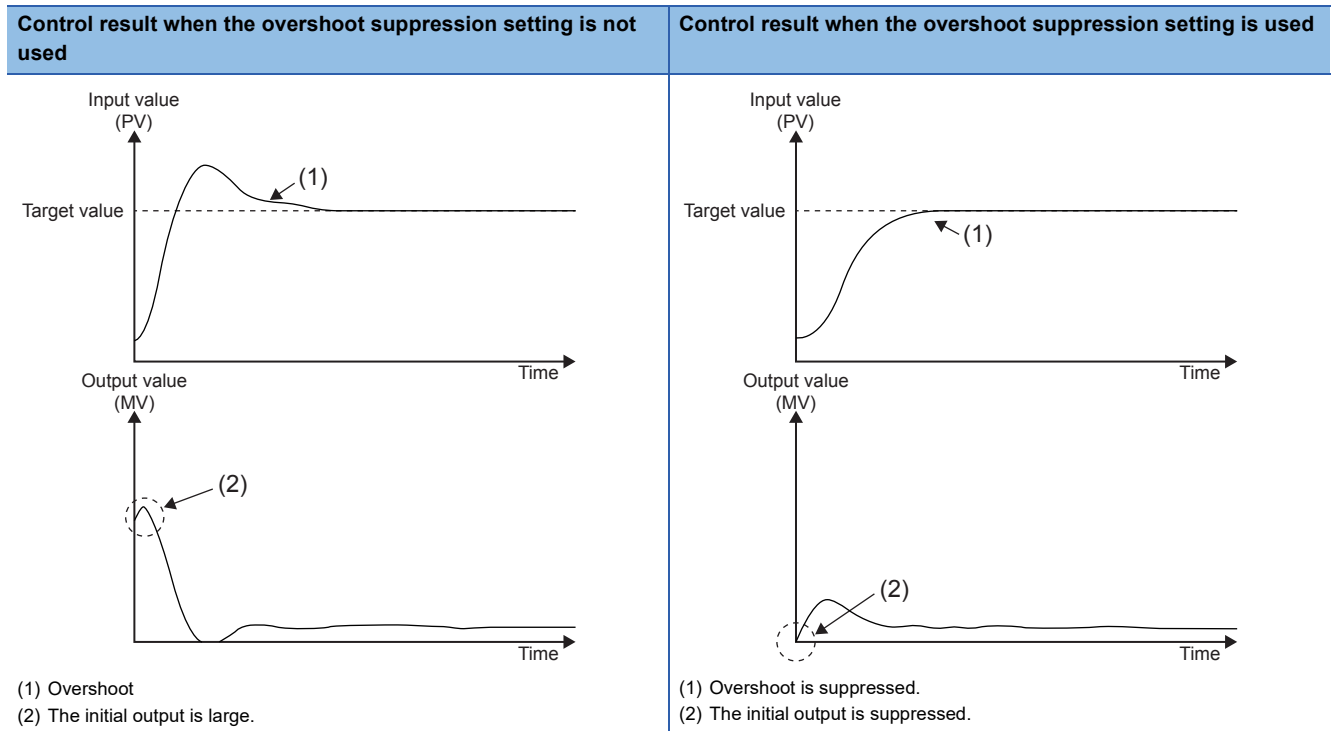

**Point**

When overshoot remains, suppress overshoot by increasing the integral time.

- Overshoot suppression by increasing the integral time

When overshoot occurs even if the initial output is suppressed by the overshoot suppression setting, increase the integral time ((s3)+4). Overshoot may be suppressed. However, when the integral time is increased excessively, reaching the target value may be delayed or remaining deviation may occur.

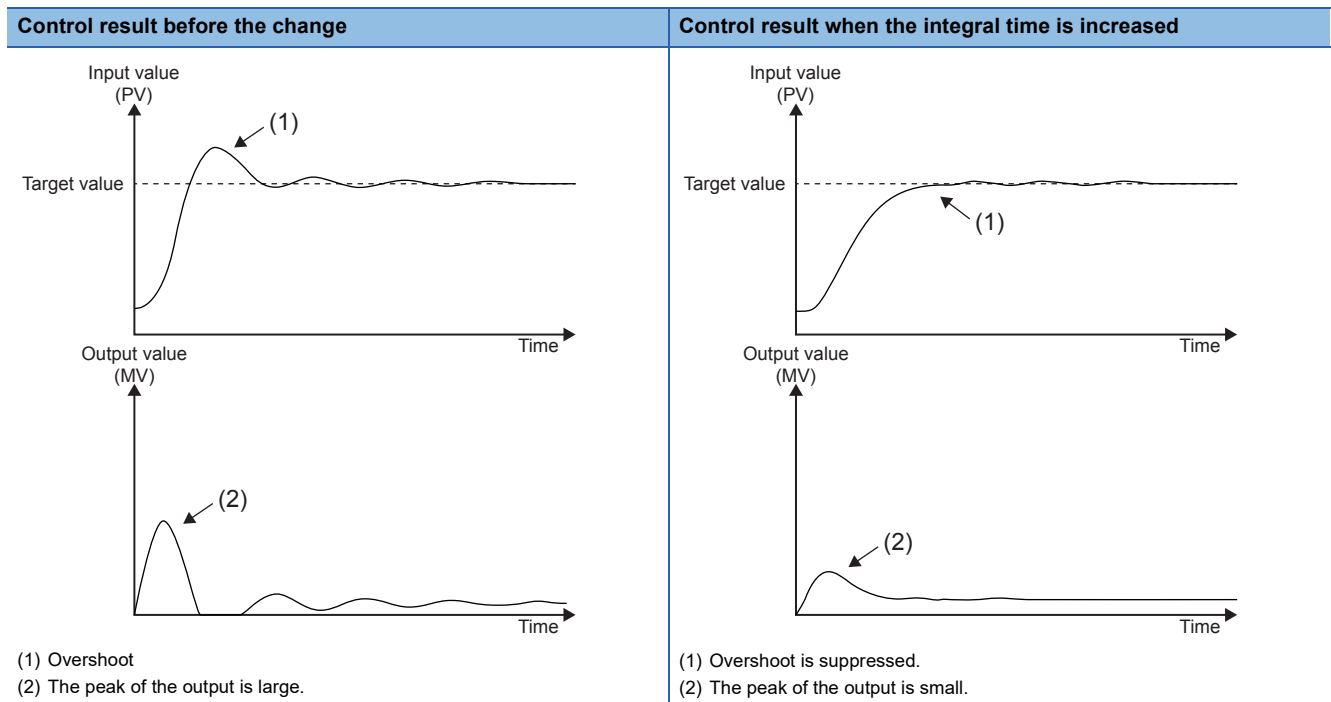

**Point**

When the first output value is large, use the overshoot suppression setting first.

- Overshoot suppression by using sampling time

When the response speed of the control target is high, shorten the sampling time ((S3)+0) to control finely. Overshoot may be suppressed. However, if the sampling time is too short, it is easily affected by momentary fluctuation of noise.

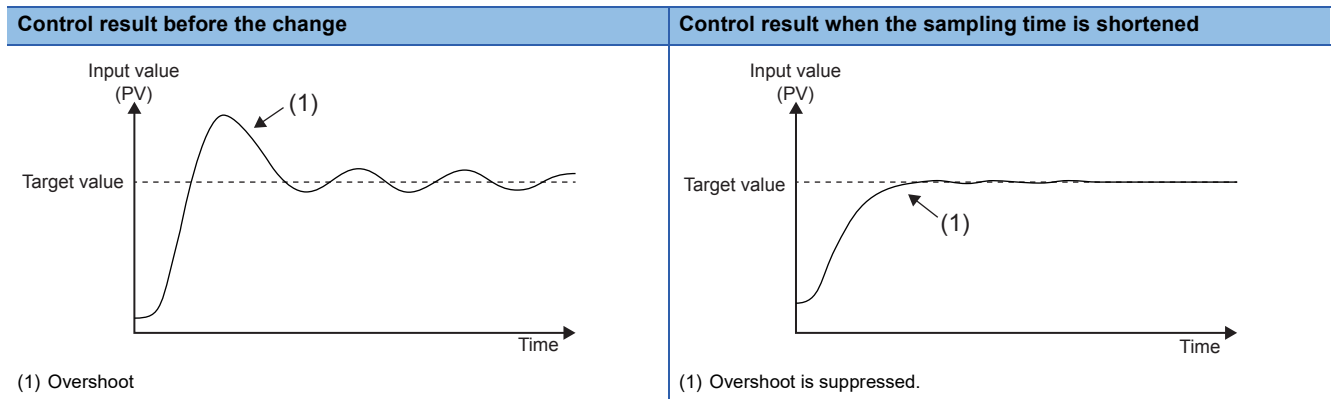

### ■Hunting suppression (When auto-tuning is executed)

When hunting occurs or the output is too large during the PID control using parameters obtained by the step response method, the parameter may be not appropriate because auto tuning is completed before the maximum ramp value that describes characteristics of the control target is obtained correctly.

Change the following setting. The correct maximum ramp value will be obtained and the result may improve.

- Hunting suppression setting

When the maximum ramp value cannot be obtained even if the settings of the sampling time and filter input value are changed, use the hunting suppression setting (turn ON b8 of ((S3)+1)). Timeout time setting value after maximum ramp detection ((S3)+25) is set so that auto tuning completion caused by a temporary ramp decrease can be avoided. Also, the timeout time (R) after maximum ramp detection setting value varies depending on the response speed of the control target.

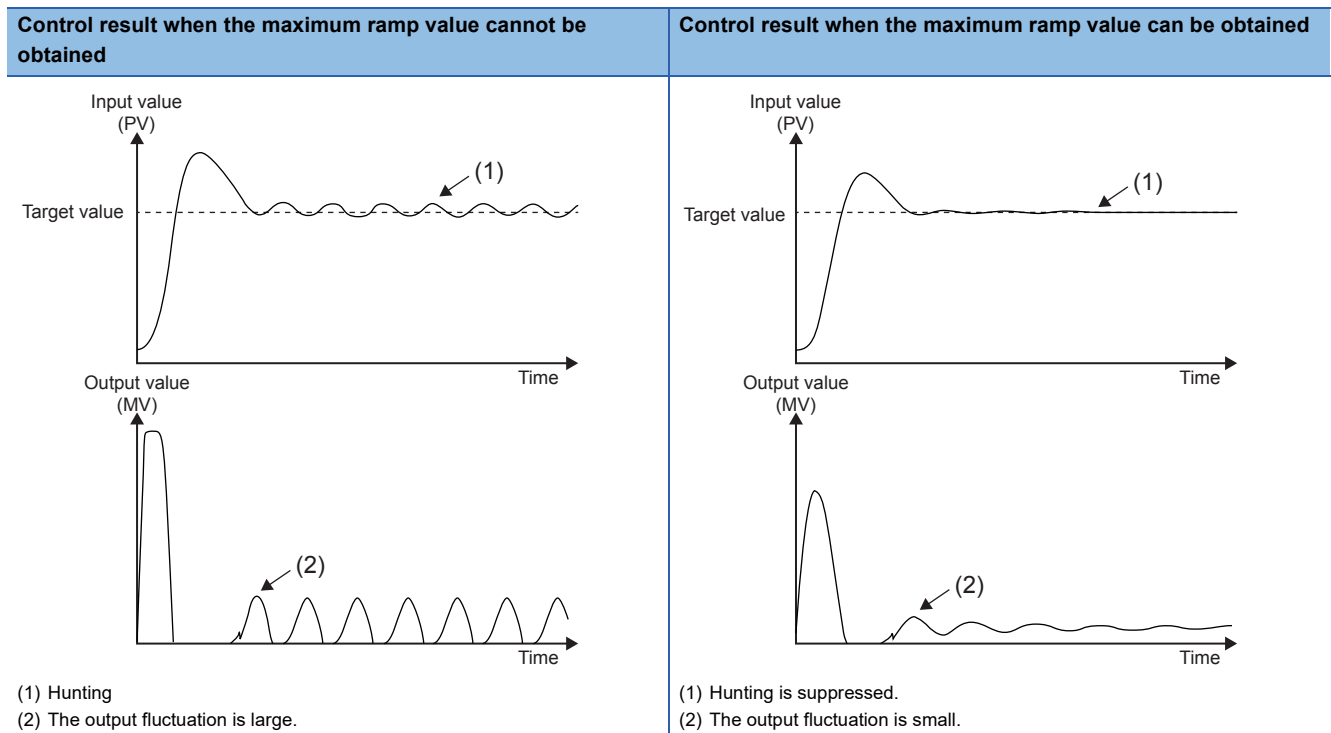

- Sampling time

When the sampling time ((S3)+0) is short, it may be determined that the ramp does not increase because of the difference of the variation between the ON part and OFF part of the output period. Set the sampling time to be not less than the time of output period.

- Input filter value

When the filter input value ((S3)+2) is small, it is easily affected by a temporary ramp decrease caused by noise. Increase the filter input value.



**■Hunting suppression (When auto-tuning is not executed)**

- Hunting suppression by decreasing the proportional gain

In the following control result case, decrease the proportional gain ((S3)+3). Hunting may be suppressed. However, if the proportional gain is too small, it takes time to reach the target value.

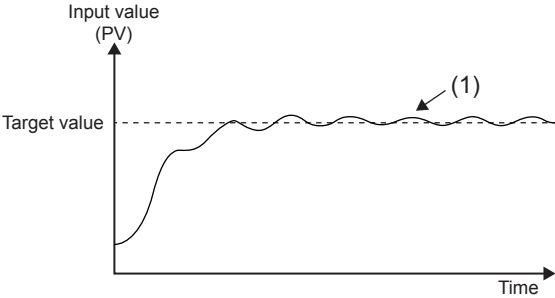
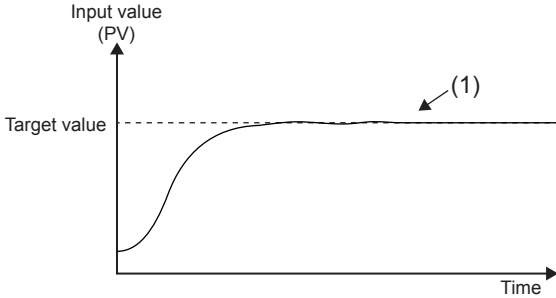
Control result before the change	Control result when the proportional gain is decreased
 <p>(1) Hunting</p>	 <p>(1) Hunting is suppressed.</p>

- Hunting suppression by increasing the differential time

In the following control result case, increase the differential time ((S3)+6). Hunting may be suppressed. However, if the differential time is too large, it is easily affected by momentary fluctuation of noise, and the control may be unstable.

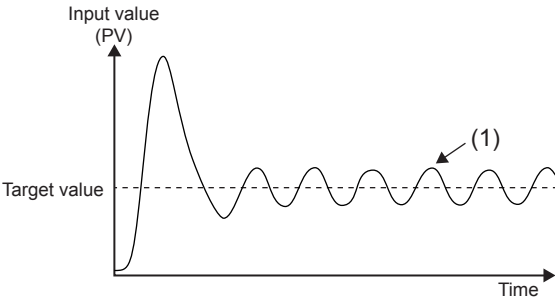
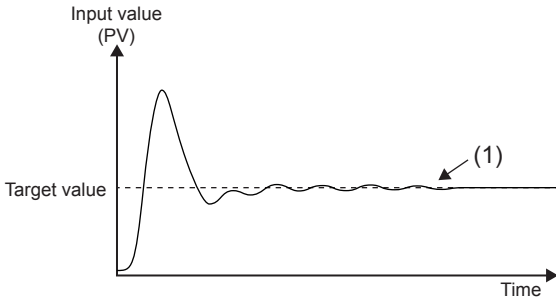
Control result before the change	Control result when the differential time is increased
 <p>(1) Hunting</p>	 <p>(1) Hunting is suppressed.</p>

- Hunting suppression time by using the sampling time

When the response speed of the control target is high, shorten the sampling time ((S3)+0) to control finely. Hunting may be suppressed. However, if the sampling time is too short, it is easily affected by momentary fluctuation of noise, and the control may be unstable.

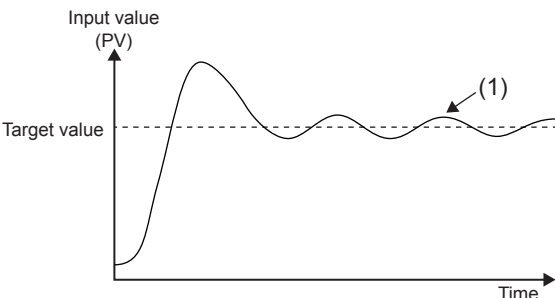
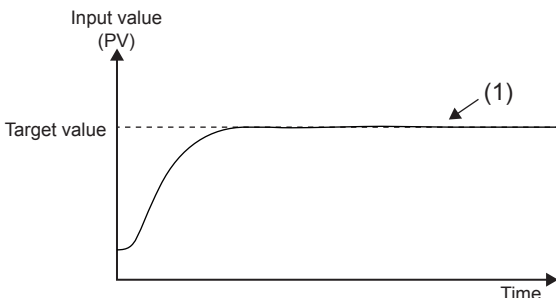
Control result before the change	Control result when the sampling time is shortened.
 <p>(1) Hunting</p>	 <p>(1) Hunting is suppressed.</p>

## Reduction of remaining deviation

When reducing the remaining deviation, the operation is as follows.

- Remaining deviation according to the input value

When the control result is stable around the target value and the required output value is small, the control result may not converge to the target value because of the influence of noise. In that case, increase the input filter constant  $((s+2))$  to suppress the influence of noise. The control result may converge to the target value.

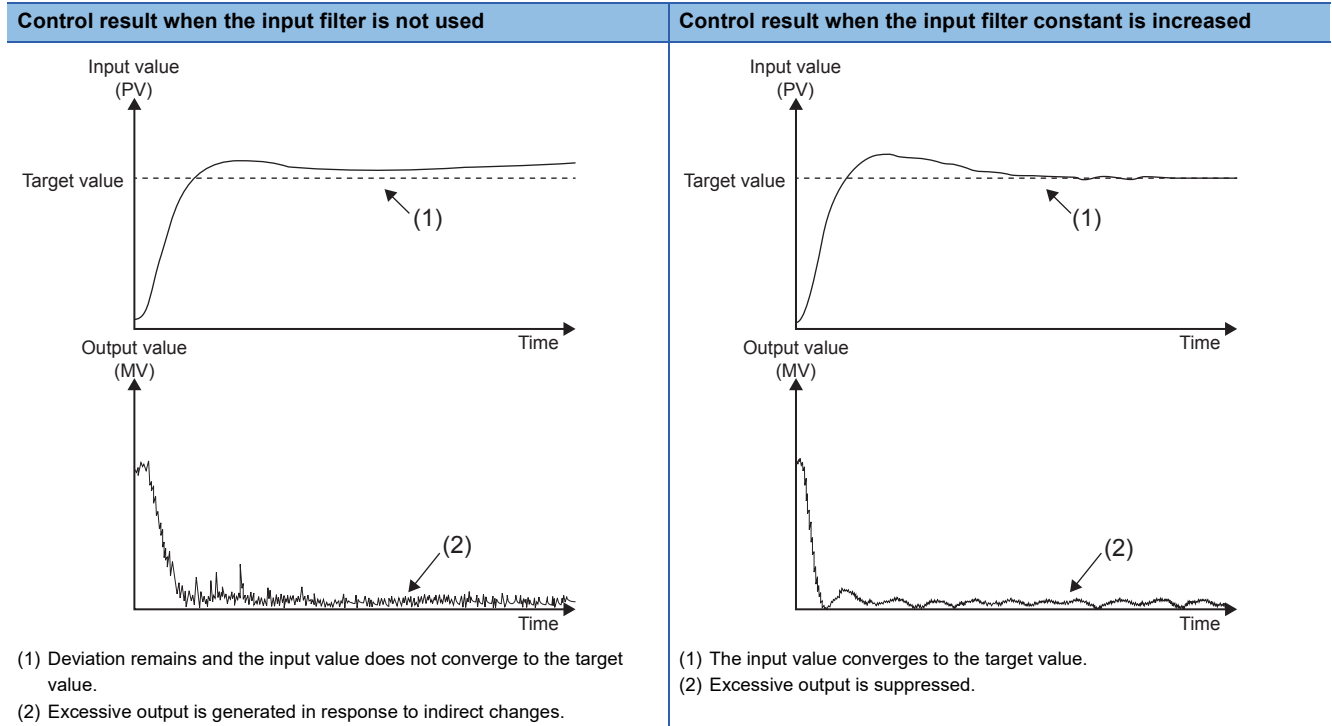

# 36.6 Function (PID Control Via Parameter)

## Outline of function

PID control is performed by setting GX Works3 parameters. To make the measured value (PV) closer to the target value (SV), the PID control calculates the output (MV) value by combining the P (proportional) action, I (integral) action, and D (derivative) action.

In addition to "Standard PID control mode", which can be executed by the PID instruction, the PID control supports "Heating-cooling PID control mode", which operates the outputs of two systems: heating control and cooling control. Therefore, temperature control with higher accuracy can be realized.

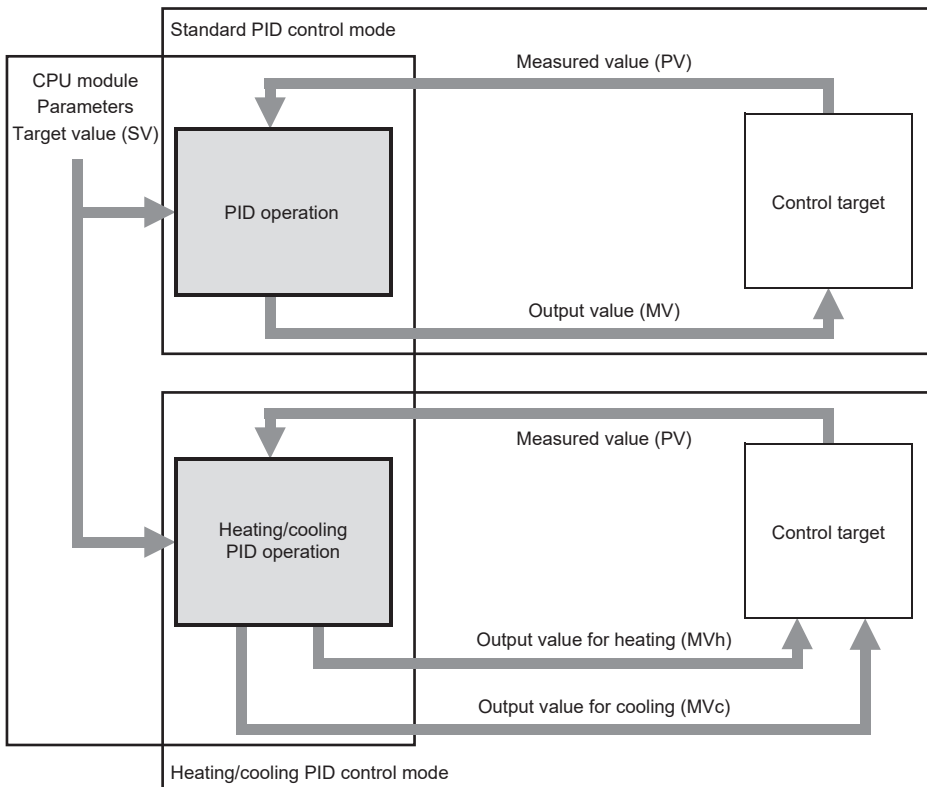

**Point**

For details on the firmware versions of the supported CPU modules and the software versions of the engineering tool, refer to the following.

Page 966 Added and Enhanced Functions

# Specifications list

The following table lists the specifications of the PID control via parameter function and the availability of each control mode.

○: Supported, ×: Not supported





Specifications		Description	Control mode		Reference
			Standard PID control	Heating-cooling PID control	
Parameter setting		Set heating/cooling PID control function data by using GX Works3 parameters.	○	○	Page 568
Control mode selection	Standard PID control	Select between standard PID control, which performs either heating control or cooling control, and heating-cooling PID control, which performs both heating control and cooling control.	○	×	Page 611
	Heating-cooling PID control		×	○	
Forward operation/backward operation selection		Select whether to perform forward operation or backward operation during standard PID control.	○	×	Page 611
Control method <sup>*1</sup>	Two-position control	Two-position control is a control method that uses the 0% output value (MV) and 100% output value (MV) for the sampling cycle. Turning on and off the output value (MV) repeatedly makes the temperature process value come close to the target value (SV), and the temperature is kept constant.	○	○	Page 612
	P control	P control is a control method that determines the output value (MV) in proportion to the deviation (E) between the temperature process value (PV) and target value (SV).	○	○	
	PI control	PI control is a control method that adds derivative elements to P control to correct an offset (remaining deviation) that remains when the temperature is stable. By setting the integral time (I) properly, the temperature process value (PV) can be matched with the target value (SV) when the temperature is stable.	○	○	
	PD control	PD control is a control method that sets the derivative time (D) in addition to P control. The control mechanism is the same as P control.	○	○	
	PID control	PID control is a control method that adds derivative elements to PI control so that the state shifts to a stable state in a short period of time even when a drastic change has occurred. By setting the derivative time (D) properly, the control target can be shifted to a stable state in a short period of time.	○	○	
Proportional gain setting function <sup>*1</sup>		Set the proportional bands (P) for heating and cooling individually. Different gradients can be set by using different proportional band (P) values in heating and cooling areas.	×	○	Page 615
Control output cycle setting function		Set the control output cycle, which is a cycle for operating a control device such as a heater and cooler.	○	○	Page 616
Auto-tuning function		Automatically set the best PID constants.	○	○	Page 617
Error display function		If an error occurs while the PID control function or auto-tuning function is being executed, store the error status and error code into the devices.	○	○	Page 623
Overlap/dead band function <sup>*1</sup>		The temperature where the cooling control output starts is shifted; therefore, select which of the control stability or energy saving is to be prioritized.	×	○	Page 624
Output limiter function		The upper limit and lower limit for the output value (MV) can be limited.	○	○	Page 625
Output change ratio limiter function <sup>*1</sup>		The output change ratio limiter limits the amount of change in the output value (MV) per unit time (1s).	○	×	Page 625
Temperature rise completion judgment function <sup>*1</sup>		Judge whether the temperature process value (PV) is within the temperature rise completion range.	○	○	Page 626
Ambient temperature setting function		For heating-cooling PID control, set the ambient temperature for comparison against the target value (SV) (which value is larger) to determine whether to perform control in the energy saving mode, which executes either heating or cooling only. When a value is set, operation is performed in the energy saving mode.	×	○	Page 626

\*1 The function is disabled during auto tuning.

## Usage procedure

---

This section describes the flow of using the PID control via parameter function as follows. Details are explained per control mode.

1. Configure "Heating/Cooling PID Control Setting" with GX Works3 CPU parameters. (  Page 606 Parameter setting)
2. Create a program. (  Page 609 Programming)
3. Write the parameters to the CPU module. (  Page 609 Operation)
4. Set the CPU module to the STOP state and to the RUN state, and turn the PID control execution command on. (  Page 609 Operation)

## Setting example

Setting examples of PID control only (setting examples 1 and 4) are shown in this chapter. For details on other program examples, refer to the following.

Setting example	Control mode	Description	Reference
Setting example 1	Standard PID control	PID control only	Page 606 Operating procedure
Setting example 2		Auto tuning + PID control	Page 628 Setting example 2
Setting example 3		Analog output using the output value (MV) (Auto tuning + PID control)	Page 630 Setting example 3
Setting example 4	Heating-cooling PID control	PID control only	Page 606 Operating procedure
Setting example 5		Auto tuning + PID control	Page 633 Setting example 5
Setting example 6		Analog output using the output value (MV) (Auto tuning + PID control)	Page 636 Setting example 6

### ■Setting example 1: Standard PID control

When "Control mode" is set to "Standard PID control mode", without performing auto tuning, PID control is performed by using the control parameters set by the user.

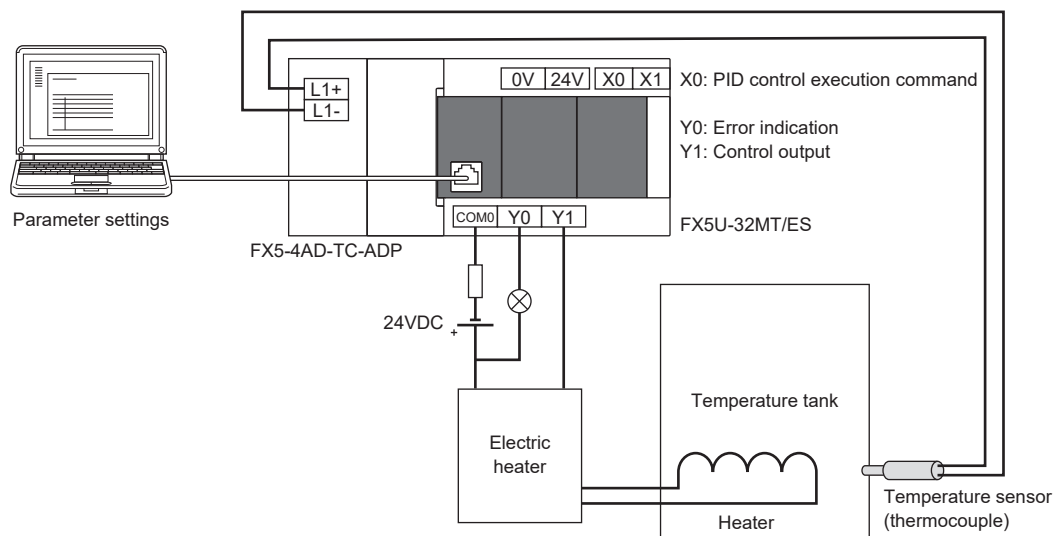

#### • Operation example

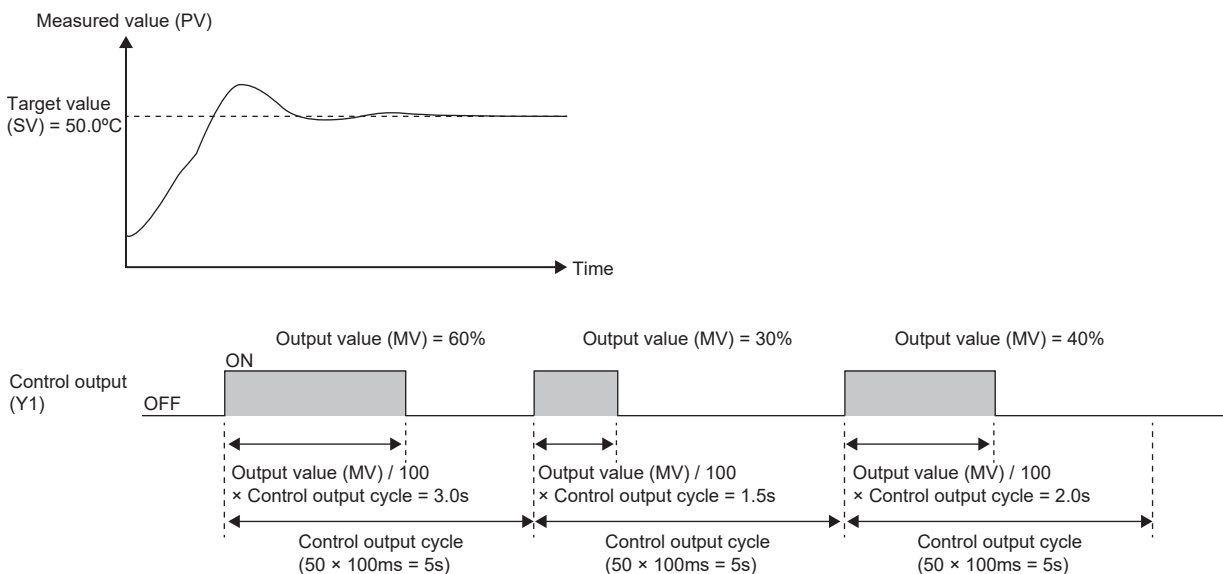

## Setting example 4: Heating-cooling PID control

When "Control mode" is set to "Heating-cooling PID control mode", without performing auto tuning, PID control is performed by using the control parameters set by the user.

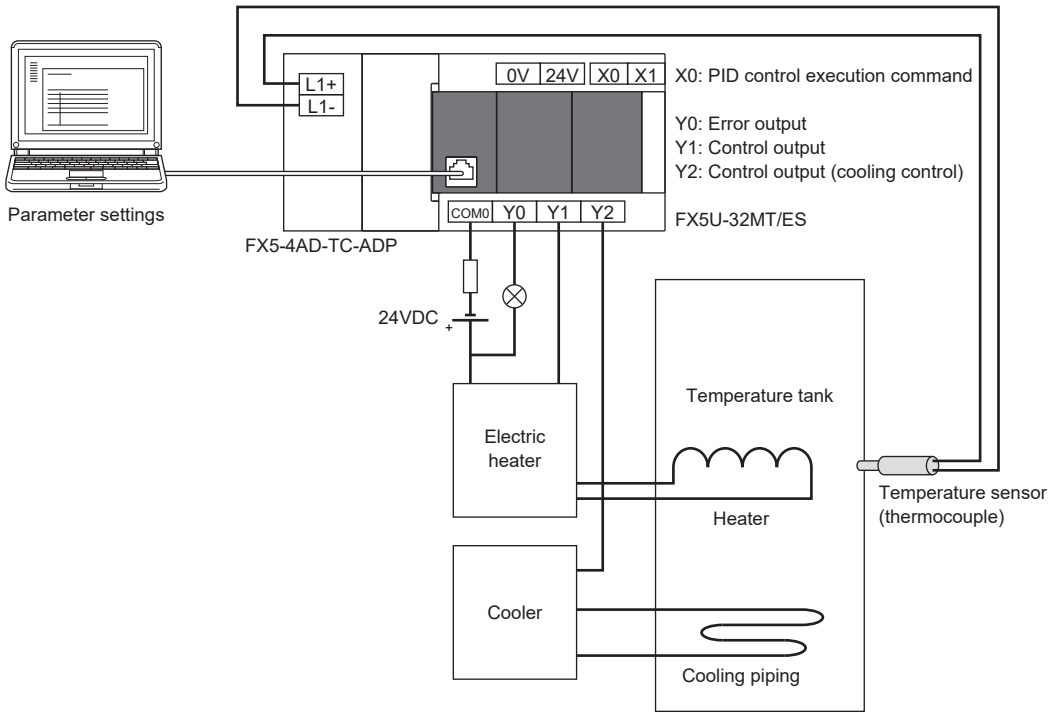

### Operation example

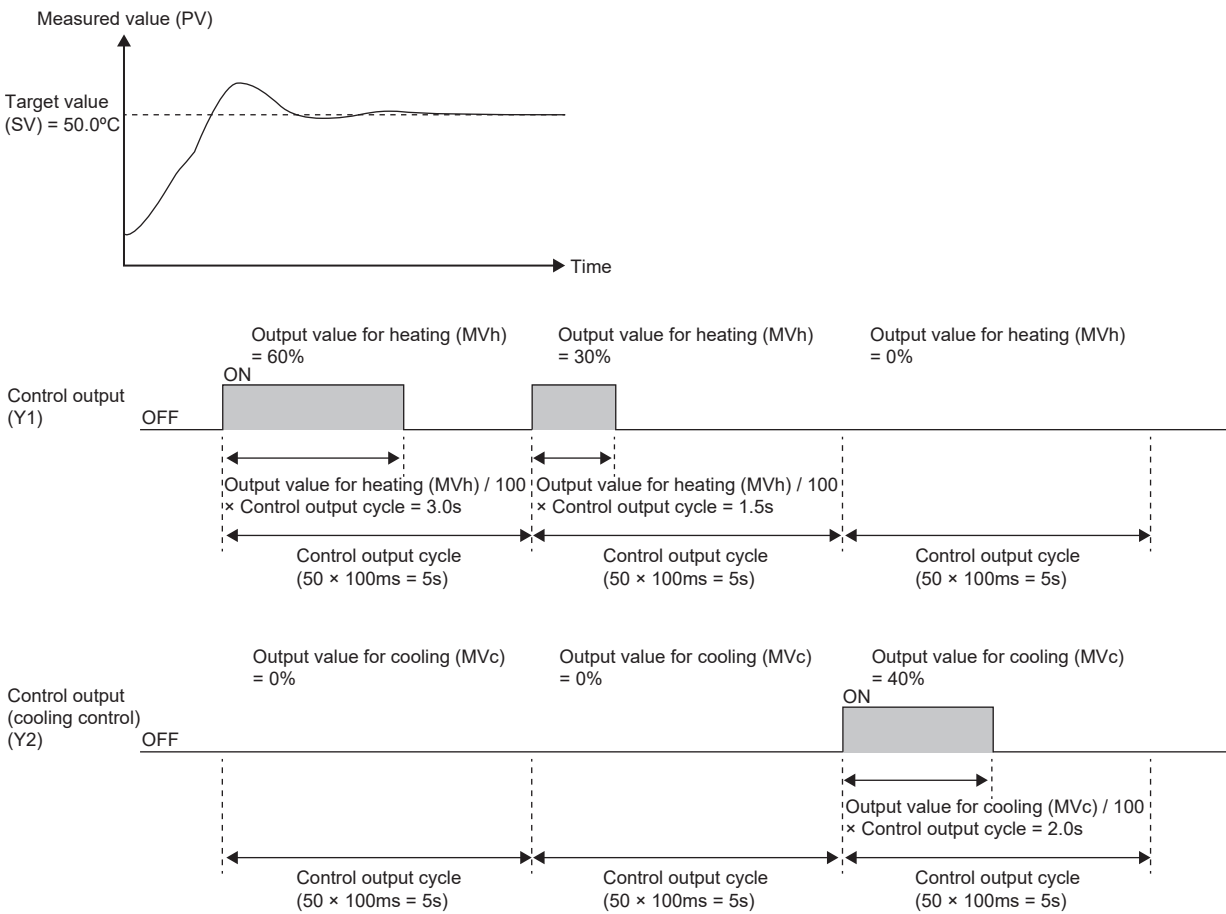

## Operating procedure

The operation procedures for setting example 1 and setting example 4 are shown below.

### Parameter setting

The following describes the parameter settings for executing PID control.

#### 1. Configure the basic settings.

[Navigation window] ⇒ [Parameter] ⇒ CPU module model name ⇒ [CPU Parameter] ⇒ [PID Control Setting] ⇒ [Heating/Cooling PID Control Setting] ⇒ [Detailed Setting] ⇒ [Basic Settings]

### Window

Setting example 1			Setting example 4		
Setting Item	Setting No.1		Item	Setting No.1	
	Setting Value	Device Indirect Specification		Setting Value	Device Indirect Specification
☐ To Use or Not to Use PID Control Function	Use		☐ To Use or Not to Use PID Control Function	Use	
☐ Control Mode Selection	Standard PID Control		☐ Control Mode Selection	Heating/Cooling PID Control	
☐ Direct Action/Reverse Action Selection	Reverse Action		☐ Direct Action/Reverse Action Selection	Reverse Action	
☐ Target Value (SV)	500	D0	☐ Target Value (SV)	500	D0
☐ Process Value (PV)	SD6300		☐ Process Value (PV)	SD6300	
☐ Output Value (MV)	D1		☐ Output Value (MV)	D1	
☐ Heating Output Value (MVh)			☐ Heating Output Value (MVh)	D2	
☐ Cooling Output Value (MVc)			☐ Cooling Output Value (MVc)	D3	
☐ Control Parameter	100 %		☐ Control Parameter	100 %	
☐ Proportional Gain (KP)	100 %		☐ Heating Proportional Gain (KPh)	100 %	
☐ Heating Proportional Gain (KPh)			☐ Cooling Proportional Gain (K Pc)	200 %	
☐ Cooling Proportional Gain (K Pc)			☐ Integral Time (TI)	200 ×100ms	
☐ Integral Time (TI)	200 ×100ms		☐ Derivative Time (TD)	300 ×100ms	
☐ Derivative Time (TD)	300 ×100ms		☐ Sampling Time (Ts)	10 ×10ms	
☐ Sampling Time (Ts)	10 ×10ms		☐ Sampling Time (Ts)	10 ×10ms	
☐ Operation Cycle	50 ×100ms		☐ Operation Cycle	100 ×100ms	
☐ Control Output Cycle	50 ×100ms		☐ Heating Control Output Cycle	50 ×100ms	
☐ Heating Control Output Cycle	100 ×100ms		☐ Cooling Control Output Cycle	100 ×100ms	
☐ Cooling Control Output Cycle	100 ×100ms		☐ Control Output	Y1	
☐ Control Output	Y1		☐ Control Output (for Cooling Control)	Y2	
☐ PID Control Execution Command	X0		☐ PID Control Execution Command	X0	
☐ To Use or Not to Use Auto-tuning			☐ To Use or Not to Use Auto-tuning		
☐ PID Control Execution Status	M0		☐ PID Control Execution Status	M0	
☐ Auto-tuning Execution Status			☐ Auto-tuning Execution Status		
☐ PID Control Function Error Display	Y0		☐ PID Control Function Error Display	Y0	
☐ PID Control Function Error Code	D10		☐ PID Control Function Error Code	D10	

### Setting data

Setting item	Setting example 1	Setting example 4
To Use or Not to Use PID Control Function	Change the setting to "Use".	Change the setting to "Use".
Control Mode Selection	Select "Standard PID Control".	Select "Heating/Cooling PID Control".
Direct Action/Reverse Action Selection	Select "Reverse Action".	—
Target Value (SV)	Set a value for at least one of the setting value and the device indirect specification.*1 • Set 500 for the setting value. • Set D0 for the device.	Set a value for at least one of the setting value and the device indirect specification.*1 • Set 500 for the setting value. • Set D0 for the device.
Process Value (PV)	Always set a value for this item. Set the measured value (CH1) of the FX5-4AD-TC-ADP. • Set SD6300.	Always set a value for this item. Set the measured value (CH1) of the FX5-4AD-TC-ADP. • Set SD6300.
Output Value (MV)	Set a value for at least one of "Output Value (MV)" and "Control Output". • Set D1 for "Output Value (MV)".	Set a value for at least one of "Output Value (MV)" and "Control Output". • Set D2 for "Heating Output Value (MVh)". • Set D3 for "Cooling Output Value (MVc)".



Setting item	Setting example 1	Setting example 4
Control Parameter	Set a value for at least one of the setting value and the device indirect specification.*1 <b>■Proportional Gain (KP)</b> <ul style="list-style-type: none"> <li>Set 100% for the setting value.</li> <li>Set D200 for the device.</li> </ul> <b>■Integral Time (TI)</b> <ul style="list-style-type: none"> <li>Set 200 × 100ms for the setting value.</li> <li>Set D203 for the device.</li> </ul> <b>■Derivative Time (TD)</b> <ul style="list-style-type: none"> <li>Set 300 × 100ms for the setting value.</li> <li>Set D204 for the device.</li> </ul>	Set a value for at least one of the setting value and the device indirect specification.*1 <b>■Heating Proportional Gain (KPh)</b> <ul style="list-style-type: none"> <li>Set 100% for the setting value.</li> <li>Set D201 for the device.</li> </ul> <b>■Cooling Proportional Gain (K Pc)</b> <ul style="list-style-type: none"> <li>Set 200% for the setting value.</li> <li>Set D202 for the device.</li> </ul> <b>■Integral Time (TI)</b> <ul style="list-style-type: none"> <li>Set 300% for the setting value.</li> <li>Set D203 for the device.</li> </ul> <b>■Derivative Time (TD)</b> <ul style="list-style-type: none"> <li>Set 400 × 100ms for the setting value.</li> <li>Set D204 for the device.</li> </ul>
Sampling Time (Ts)	Set a value for at least one of the setting value and the device indirect specification.*1 <ul style="list-style-type: none"> <li>Set 10 × 10ms for the setting value.*2</li> <li>Set D300 for the device.</li> </ul>	Set a value for at least one of the setting value and the device indirect specification.*1 <ul style="list-style-type: none"> <li>Set 10 × 10ms for the setting value.</li> <li>Set D300 for the device.</li> </ul>
Operation Cycle	Set a value for at least one of the setting value and the device indirect specification.*1 <b>■Control Output Cycle</b> <ul style="list-style-type: none"> <li>Set 50 × 100ms for the setting value.*2</li> <li>Set D301 for the device.</li> </ul>	Set a value for at least one of the setting value and the device indirect specification.*1 <b>■Heating Control Output Cycle</b> <ul style="list-style-type: none"> <li>Set 50 × 100ms for the setting value.</li> <li>Set D302 for the device.</li> </ul> <b>■Cooling Control Output Cycle</b> <ul style="list-style-type: none"> <li>Set 50 × 100ms for the setting value.</li> <li>Set D303 for the device.</li> </ul>
Control Output	Set a value for at least one of "Output Value (MV)" and "Control Output". <ul style="list-style-type: none"> <li>Set Y1 for "Control Output".</li> </ul>	Set a value for at least one of "Output Value (MV)" and "Control Output". <ul style="list-style-type: none"> <li>Set Y1 for "Control Output".</li> <li>Set Y2 for "Control Output (for Cooling Control)".</li> </ul>
PID Control Execution Command	Always set a value for this item. <ul style="list-style-type: none"> <li>Set X0.</li> </ul>	Always set a value for this item. <ul style="list-style-type: none"> <li>Set X0.</li> </ul>
To Use or Not to Use Auto-tuning	When the set device is turned on, auto tuning becomes available. When the set device is turned off, or no value is set for the device, operation is performed without auto tuning. <ul style="list-style-type: none"> <li>This item is not set in this example.</li> </ul>	When the set device is turned on, auto tuning becomes available. When the set device is turned off, or no value is set for the device, operation is performed without auto tuning. <ul style="list-style-type: none"> <li>This item is not set in this example.</li> </ul>
PID Control Execution Status	Set this item when monitoring the PID control execution status. <ul style="list-style-type: none"> <li>Set M0.</li> </ul>	Set this item when monitoring the PID control execution status. <ul style="list-style-type: none"> <li>Set M0.</li> </ul>
Auto-tuning Execution Status	Set this item when monitoring the auto tuning execution status. <ul style="list-style-type: none"> <li>This item is not set in this example.</li> </ul>	Set this item when monitoring the auto tuning execution status. <ul style="list-style-type: none"> <li>This item is not set in this example.</li> </ul>
PID Control Function Error Display	Set this item when monitoring the error status during PID control. <ul style="list-style-type: none"> <li>Set Y0.</li> </ul>	Set this item when monitoring the error status during PID control. <ul style="list-style-type: none"> <li>Set Y0.</li> </ul>
PID Control Function Error Code	Set this item when monitoring the error code of the error that has occurred during PID control. <ul style="list-style-type: none"> <li>Set D10.</li> </ul>	Set this item when monitoring the error code of the error that has occurred during PID control. <ul style="list-style-type: none"> <li>Set D10.</li> </ul>

\*1 To monitor or change during control, set a value for both the setting value and the device indirect specification or only the device indirect specification.

\*2 Set a value larger than the scan time. Also set a value so that the sampling time (TS) becomes smaller than the control output cycle.

## 2. Configure application settings.

[Navigation window] ⇒ [Parameter] ⇒ CPU module model name ⇒ [CPU Parameter] ⇒ [PID Control Setting] ⇒ [Heating/Cooling PID Control Setting] ⇒ [Detailed Setting] ⇒ [Application Setting]

### Window

Setting example 1	Setting example 4																																																																																																																																																								
<table border="1"> <thead> <tr> <th colspan="2">Setting Item</th> <th colspan="2">Setting No.1</th> </tr> <tr> <th>Item</th> <th>Setting Value</th> <th colspan="2">Device Indirect Specification</th> </tr> </thead> <tbody> <tr> <td><b>2-position Control Function</b></td> <td></td> <td></td> <td></td> </tr> <tr> <td>  Adjustment Sensitivity (Dead Band)</td> <td>10</td> <td></td> <td></td> </tr> <tr> <td><b>Overlap/Dead Band Setting</b></td> <td></td> <td></td> <td></td> </tr> <tr> <td>  Overlap/Dead Band Setting</td> <td>0</td> <td></td> <td></td> </tr> <tr> <td><b>Output Limiter Function</b></td> <td></td> <td></td> <td></td> </tr> <tr> <td>  Upper Limit Output Limiter</td> <td>900 × 0.1%</td> <td>D410</td> <td></td> </tr> <tr> <td>  Lower Limit Output Limiter</td> <td>0 × 0.1%</td> <td>D411</td> <td></td> </tr> <tr> <td>  Heating Upper Limit Output Limiter</td> <td>1000 × 0.1%</td> <td></td> <td></td> </tr> <tr> <td>  Cooling Upper Limit Output Limiter</td> <td>1000 × 0.1%</td> <td></td> <td></td> </tr> <tr> <td><b>Output Variation Rate Limiter Function</b></td> <td></td> <td></td> <td></td> </tr> <tr> <td>  Output Variation Rate Limiter</td> <td>0 × 0.1%/s</td> <td>D414</td> <td></td> </tr> <tr> <td><b>Temperature Rise Completion Judgement Function</b></td> <td></td> <td></td> <td></td> </tr> <tr> <td>  Temperature Rise Judgment Flag</td> <td></td> <td>M3</td> <td></td> </tr> <tr> <td>  Temperature Rise Completion Range</td> <td>50</td> <td>D415</td> <td></td> </tr> <tr> <td>  Temperature Rise Completion Soak Time</td> <td>5 s</td> <td>D416</td> <td></td> </tr> <tr> <td><b>Ambient Temperature Setting</b></td> <td></td> <td></td> <td></td> </tr> <tr> <td>  Ambient Temperature Setting</td> <td></td> <td></td> <td></td> </tr> </tbody> </table>	Setting Item		Setting No.1		Item	Setting Value	Device Indirect Specification		<b>2-position Control Function</b>				Adjustment Sensitivity (Dead Band)	10			<b>Overlap/Dead Band Setting</b>				Overlap/Dead Band Setting	0			<b>Output Limiter Function</b>				Upper Limit Output Limiter	900 × 0.1%	D410		Lower Limit Output Limiter	0 × 0.1%	D411		Heating Upper Limit Output Limiter	1000 × 0.1%			Cooling Upper Limit Output Limiter	1000 × 0.1%			<b>Output Variation Rate Limiter Function</b>				Output Variation Rate Limiter	0 × 0.1%/s	D414		<b>Temperature Rise Completion Judgement Function</b>				Temperature Rise Judgment Flag		M3		Temperature Rise Completion Range	50	D415		Temperature Rise Completion Soak Time	5 s	D416		<b>Ambient Temperature Setting</b>				Ambient Temperature Setting				<table border="1"> <thead> <tr> <th colspan="2">Setting Item</th> <th colspan="2">Setting No.1</th> </tr> <tr> <th>Item</th> <th>Setting Value</th> <th colspan="2">Device Indirect Specification</th> </tr> </thead> <tbody> <tr> <td><b>2-position Control Function</b></td> <td></td> <td></td> <td></td> </tr> <tr> <td>  Adjustment Sensitivity (Dead Band)</td> <td>10</td> <td></td> <td></td> </tr> <tr> <td><b>Overlap/Dead Band Setting</b></td> <td></td> <td></td> <td></td> </tr> <tr> <td>  Overlap/Dead Band Setting</td> <td>0</td> <td></td> <td></td> </tr> <tr> <td><b>Output Limiter Function</b></td> <td></td> <td></td> <td></td> </tr> <tr> <td>  Upper Limit Output Limiter</td> <td>1000 × 0.1%</td> <td></td> <td></td> </tr> <tr> <td>  Lower Limit Output Limiter</td> <td>0 × 0.1%</td> <td></td> <td></td> </tr> <tr> <td>  Heating Upper Limit Output Limiter</td> <td>900 × 0.1%</td> <td>D412</td> <td></td> </tr> <tr> <td>  Cooling Upper Limit Output Limiter</td> <td>900 × 0.1%</td> <td>D413</td> <td></td> </tr> <tr> <td><b>Output Variation Rate Limiter Function</b></td> <td></td> <td></td> <td></td> </tr> <tr> <td>  Output Variation Rate Limiter</td> <td>0 × 0.1%/s</td> <td></td> <td></td> </tr> <tr> <td><b>Temperature Rise Completion Judgement Function</b></td> <td></td> <td></td> <td></td> </tr> <tr> <td>  Temperature Rise Judgment Flag</td> <td></td> <td>M3</td> <td></td> </tr> <tr> <td>  Temperature Rise Completion Range</td> <td>50</td> <td>D415</td> <td></td> </tr> <tr> <td>  Temperature Rise Completion Soak Time</td> <td>5 s</td> <td>D416</td> <td></td> </tr> <tr> <td><b>Ambient Temperature Setting</b></td> <td></td> <td></td> <td></td> </tr> <tr> <td>  Ambient Temperature Setting</td> <td></td> <td></td> <td></td> </tr> </tbody> </table>	Setting Item		Setting No.1		Item	Setting Value	Device Indirect Specification		<b>2-position Control Function</b>				Adjustment Sensitivity (Dead Band)	10			<b>Overlap/Dead Band Setting</b>				Overlap/Dead Band Setting	0			<b>Output Limiter Function</b>				Upper Limit Output Limiter	1000 × 0.1%			Lower Limit Output Limiter	0 × 0.1%			Heating Upper Limit Output Limiter	900 × 0.1%	D412		Cooling Upper Limit Output Limiter	900 × 0.1%	D413		<b>Output Variation Rate Limiter Function</b>				Output Variation Rate Limiter	0 × 0.1%/s			<b>Temperature Rise Completion Judgement Function</b>				Temperature Rise Judgment Flag		M3		Temperature Rise Completion Range	50	D415		Temperature Rise Completion Soak Time	5 s	D416		<b>Ambient Temperature Setting</b>				Ambient Temperature Setting			
Setting Item		Setting No.1																																																																																																																																																							
Item	Setting Value	Device Indirect Specification																																																																																																																																																							
<b>2-position Control Function</b>																																																																																																																																																									
Adjustment Sensitivity (Dead Band)	10																																																																																																																																																								
<b>Overlap/Dead Band Setting</b>																																																																																																																																																									
Overlap/Dead Band Setting	0																																																																																																																																																								
<b>Output Limiter Function</b>																																																																																																																																																									
Upper Limit Output Limiter	900 × 0.1%	D410																																																																																																																																																							
Lower Limit Output Limiter	0 × 0.1%	D411																																																																																																																																																							
Heating Upper Limit Output Limiter	1000 × 0.1%																																																																																																																																																								
Cooling Upper Limit Output Limiter	1000 × 0.1%																																																																																																																																																								
<b>Output Variation Rate Limiter Function</b>																																																																																																																																																									
Output Variation Rate Limiter	0 × 0.1%/s	D414																																																																																																																																																							
<b>Temperature Rise Completion Judgement Function</b>																																																																																																																																																									
Temperature Rise Judgment Flag		M3																																																																																																																																																							
Temperature Rise Completion Range	50	D415																																																																																																																																																							
Temperature Rise Completion Soak Time	5 s	D416																																																																																																																																																							
<b>Ambient Temperature Setting</b>																																																																																																																																																									
Ambient Temperature Setting																																																																																																																																																									
Setting Item		Setting No.1																																																																																																																																																							
Item	Setting Value	Device Indirect Specification																																																																																																																																																							
<b>2-position Control Function</b>																																																																																																																																																									
Adjustment Sensitivity (Dead Band)	10																																																																																																																																																								
<b>Overlap/Dead Band Setting</b>																																																																																																																																																									
Overlap/Dead Band Setting	0																																																																																																																																																								
<b>Output Limiter Function</b>																																																																																																																																																									
Upper Limit Output Limiter	1000 × 0.1%																																																																																																																																																								
Lower Limit Output Limiter	0 × 0.1%																																																																																																																																																								
Heating Upper Limit Output Limiter	900 × 0.1%	D412																																																																																																																																																							
Cooling Upper Limit Output Limiter	900 × 0.1%	D413																																																																																																																																																							
<b>Output Variation Rate Limiter Function</b>																																																																																																																																																									
Output Variation Rate Limiter	0 × 0.1%/s																																																																																																																																																								
<b>Temperature Rise Completion Judgement Function</b>																																																																																																																																																									
Temperature Rise Judgment Flag		M3																																																																																																																																																							
Temperature Rise Completion Range	50	D415																																																																																																																																																							
Temperature Rise Completion Soak Time	5 s	D416																																																																																																																																																							
<b>Ambient Temperature Setting</b>																																																																																																																																																									
Ambient Temperature Setting																																																																																																																																																									

### Setting data

Setting item	Setting example 1	Setting example 4
2-position Control Function	Set a value for at least one of the setting value and the device indirect specification. <sup>*1*2</sup> <ul style="list-style-type: none"> <li>Set 10 (default value) for the setting value for "Adjustment Sensitivity (Dead Band)".</li> </ul>	Set a value for at least one of the setting value and the device indirect specification. <sup>*1*2</sup> <ul style="list-style-type: none"> <li>Set 10 (default value) for the setting value for "Adjustment Sensitivity (Dead Band)".</li> </ul>
Overlap/Dead Band Setting	—	Set a value for at least one of the setting value and the device indirect specification. <sup>*1</sup> Negative setting values are for overlapping, and positive setting values are for the dead band. Setting 0 disables the overlap/dead band settings. <ul style="list-style-type: none"> <li>Set D401.</li> </ul>
Output Limiter Function	Set a value for at least one of the setting value and the device indirect specification. <sup>*1*2</sup> <ul style="list-style-type: none"> <li>■ Upper Limit Output Limiter               <ul style="list-style-type: none"> <li>Set 900 × 0.1% for the setting value.</li> <li>Set D410 for the device.</li> </ul> </li> <li>■ Lower Limit Output Limiter               <ul style="list-style-type: none"> <li>Set 0 × 0.1% for the setting value.</li> <li>Set D411 for the device.</li> </ul> </li> </ul>	Set a value for at least one of the setting value and the device indirect specification. <sup>*1*2</sup> <ul style="list-style-type: none"> <li>■ Heating Upper Limit Output Limiter               <ul style="list-style-type: none"> <li>Set 900 × 0.1% for the setting value.</li> <li>Set D412 for the device.</li> </ul> </li> <li>■ Cooling Upper Limit Output Limiter               <ul style="list-style-type: none"> <li>Set 900 × 0.1% for the setting value.</li> <li>Set D413 for the device.</li> </ul> </li> </ul>
Output Variation Rate Limiter Function	Set a value for at least one of the setting value and the device indirect specification. <sup>*1*2</sup> <ul style="list-style-type: none"> <li>The setting value must be 0 × 0.1%/s (default value).</li> <li>Set D414 for the device.</li> </ul>	—
Temperature Rise Completion Judgement Function	To judge whether the value for "Process Value (PV)" is within the temperature rise completion range, set the device for the temperature rise judgment flag. <ul style="list-style-type: none"> <li>■ Temperature Rise Judgment Flag               <ul style="list-style-type: none"> <li>Set M3.</li> </ul> </li> <li>■ Temperature Rise Completion Range <sup>*1</sup> <ul style="list-style-type: none"> <li>Set 50 for the setting value.</li> <li>Set D415 for the device.</li> </ul> </li> <li>■ Upper Limit Output Limiter <sup>*1</sup> <ul style="list-style-type: none"> <li>Set 5s for the setting value.</li> <li>Set D416 for the device.</li> </ul> </li> </ul>	To judge whether the value for "Process Value (PV)" is within the temperature rise completion range, set the device for the temperature rise judgment flag. <ul style="list-style-type: none"> <li>■ Temperature Rise Judgment Flag               <ul style="list-style-type: none"> <li>Set M3.</li> </ul> </li> <li>■ Temperature Rise Completion Range <sup>*1</sup> <ul style="list-style-type: none"> <li>Set 50 for the setting value.</li> <li>Set D415 for the device.</li> </ul> </li> <li>■ Upper Limit Output Limiter <sup>*1</sup> <ul style="list-style-type: none"> <li>Set 5s for the setting value.</li> <li>Set D416 for the device.</li> </ul> </li> </ul>
Ambient Temperature Setting	—	This item is not set in this example. <sup>*1</sup>

<sup>\*1</sup> To monitor or change during control, set a value for both the setting value and the device indirect specification or only the device indirect specification.

<sup>\*2</sup> When not using the function, the default value need not be changed.

## 3. After setting, click [OK] to complete the heating-cooling PID setting.

## ■Programming

Data other than the data set using parameters is set using a program. The program example is common to setting example 1 and setting example 4.

Set use permission for the FX5-4AD-TC-ADP(CH1), which was set as the process value (SD6300) when the state was changed from STOP to RUN.

Item	Device indirect specification	Description
A/D conversion enable/disable setting (CH1)	SM6301	FX5-4AD-TC-ADP(CH1) A/D conversion enable/disable setting • 0: Enable • 1: Disable

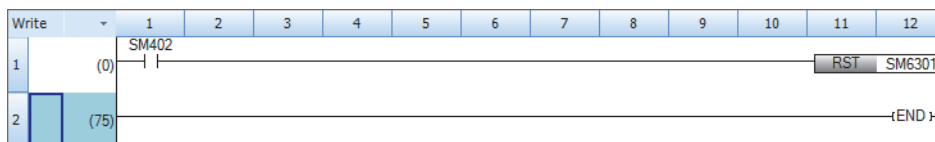

## ■Operation

1. Write the created project to the CPU module.
2. To use auto tuning, turn on the item Auto tuning used/not used. (This item is not using in this example.)
3. Set the CPU module to the STOP state and to the RUN state, and turn the X0 (PID control execution command) on.

## Heating-cooling PID setting parameter

The following tables show the details of the heating-cooling PID settings configured with GX Works3 CPU parameters.



When the operating status of the CPU module is changed from STOP to RUN, for the parameters for which both the setting value and device indirect specification are set, the set values are stored in the devices.

### Basic settings

○: Supported, ×: Not supported

Setting item	Setting range	Control mode		Device type	R/W		
		Standard PID control	Heating-cooling PID control		User	System	
To Use or Not to Use PID Control Function	• Not use (default) • Use	○	○	—	W	R	
Control Mode Selection	• Standard PID Control (default) • Heating-cooling PID Control	○	○	—	W	R	
Direct Action/Reverse Action Selection	• Direct Action • Reverse Action (default)	○	×	—	W	R	
Target Value (SV)	-32760 to 32760	○	○	D, R	W	R	
Process Value (PV)	-32768 to 32767	○	○	SD, D, R	W	R	
Output Value (MV)	0 to 1000[×0.1%]	○	×	D, R	R/W	R/W	
Heating Output Value (MVh)	0 to 1000[×0.1%]	×	○	D, R	R	R/W	
Cooling Output Value (MVc)	0 to 1000[×0.1%]	×	○	D, R	R	R/W	
Control Parameter	Proportional Gain (KP)	0 to 32767[%]	○	×	D, R	R/W	R/W
	Heating Proportional Gain (KPh)	0 to 32767[%]	×	○	D, R	R/W	R/W
	Cooling Proportional Gain (KPC)	1 to 32767[%]	×	○	D, R	R/W	R/W
	Integral Time (TI)	0 to 32767[×100ms]	○	○	D, R	R/W	R/W
	Derivative Time (TD)	0 to 32767[×100ms]	○	○	D, R	R/W	R/W
Sampling Time (Ts)	1 to 3000[×10ms] (Default: 100)	○	○	D, R	W	R	

Setting item		Setting range	Control mode		Device type	R/W	
			Standard PID control	Heating-cooling PID control		User	System
Operation Cycle	Control Output Cycle	1 to 3000[×100ms] (Default: 100)	○	×	D, R	W	R
	Heating Control Output Cycle	1 to 3000[×100ms] (Default: 100)	×	○	D, R	W	R
	Cooling Control Output Cycle	1 to 3000[×100ms] (Default: 100)	×	○	D, R	W	R
Control Output		ON/OFF	○	○	Y, M	R	W
Control Output (for Cooling Control)		ON/OFF	×	○	Y, M	R	W
PID Control Execution Command		• 0: PID control not executed • 1: PID control executed	○	○	X, M, SM	W	R
To Use or Not to Use Auto-tuning		• 0: Auto tuning not used • 1: Auto tuning used	○	○	X, M, SM	W	R
PID Control Execution Status		• 0: PID control stopped • 1: PID control being executed	○	○	Y, M	R	W
Auto-tuning Execution Status		• 0: Auto tuning stopped • 1: Auto tuning being executed	○	○	Y, M	R	W
PID Control Function Error Display		• 0: No error occurrence • 1: Error occurrence	○	○	Y, M	R	W
PID Control Function Error Code		-32768 to 32767	○	○	D, R	R	W

## Application settings

○: Supported, ×: Not supported

Setting item		Description/Setting range	Control mode		Device type	R/W	
			Standard PID control	Heating-cooling PID control		User	System
2-position Control Function	Adjustment sensitivity (dead band)	0 to 32760	○	○	D, R	W	R
Overlap/Dead Band Setting		-32768 to 32767 (Default: 0)	×	○*1	D, R	W	R
Output Limiter Function	Upper Limit Output Limiter	Lower Limit Output Limiter + 1 to 1000[×0.1%] (Default: 1000)	○	×	D, R	W	R
	Lower Limit Output Limiter	0 to Upper Limit Output Limiter - 1[×0.1%] (Default: 0)	○	×	D, R	W	R
	Heating Upper Limit Output Limiter	0 to 1000[×0.1%] (Default: 1000)	×	○	D, R	W	R
	Cooling Upper Limit Output Limiter	0 to 1000[×0.1%] (Default: 1000)	×	○	D, R	W	R
Output Variation Rate Limiter Function	Output Variation Rate Limiter	0 to 1000[×0.1%/s] (Default: 0)	○	×	D, R	W	R
Temperature Rise Completion Judgement Function	Temperature Rise Judgment Flag	• 0: Temperature rise not completed • 1: Temperature rise completed	○	○	Y, M	R	W
	Temperature Rise Completion Range	0 to 32760	○	○	D, R	W	R
	Temperature Rise Completion Soak Time	0 to 32767[s]	○	○	D, R	W	R
Ambient Temperature Setting		-32768 to 32767	×	○	D, R	W	R

\*1 When the firmware version of the FX5U/FX5UC CPU module is "1.290" or later, the settings can be configured. For the firmware version earlier than "1.290", set 0 for the setting value and empty for the device indirect specification.

# Details of specifications

This section describes the details of the specifications of the heating-cooling PID control function.

## Control mode selection

Two types of control modes are available: Standard PID control and heating-cooling PID control.

### ■Standard PID control

Standard PID control is a control method that operates the output for either one of the forward operation (cooling control) system and the backward operation (heating control) system.

In any of the two operations, to make the measured value (PV)<sup>\*1</sup> closer to the target value (SV), the output value (MV) is calculated from the measured value (PV) by combining P (proportional) action, I (integral) action, and D (derivative) action.

\*1 The measured value (PV) used in the control is the mean value of the last 10 measured values (PV) including when PID control is executed.

### ■Heating-cooling PID control

Heating-cooling PID control is a control method that operates the outputs for both the forward operation (cooling control) system and the backward operation (heating control) system.

By operating the outputs for the two systems, to make the measured value (PV)<sup>\*1</sup> closer to the target value (SV), the output value (MV) is calculated from the measured value (PV) by combining P (proportional) action, I (integral) action, and D (derivative) action.

\*1 The measured value (PV) used in the control is the mean value of the last 10 measured values (PV) including when PID control is executed.

## Forward operation/backward operation selection

This item is used to select whether to perform forward operation (cooling control) or backward operation (heating control) during standard PID control.

Both forward operation and backward operation can be used in all control methods (two-position control, P control, PI control, PD control, PID control).

### ■Forward operation

Forward operation is operation that increases the output value (MV) when the measured value (PV) becomes larger than the target value (SV). This operation is used when performing cooling control.

The deviation (E) for forward operation is calculated by subtracting the target value (SV) from the measured value (PV).

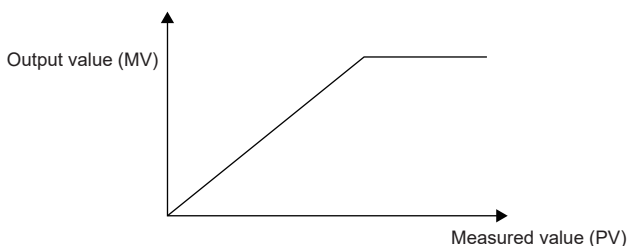

### ■Backward operation



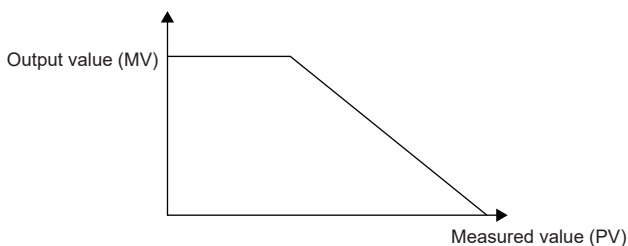

Backward operation is operation that increases the output value (MV) when the measured value (PV) becomes smaller than the target value (SV). This operation is used when performing heating control.

The deviation (E) for backward operation is calculated by subtracting the measured value (PV) from the target value (SV).



## Control method

The following control methods can be executed by setting a proportional gain, integral time, and derivative time.

- Two-position control (  Page 612 Two-position control)
- P control (  Page 614 P control)
- PD control (  Page 615 PD control)
- PID control (  Page 615 PID control)

### ■Two-position control

Two-position control is a control method that uses the 0% output value (MV) and 100% output value (MV) in each END processing operation. Turning on and off the output value (MV) repeatedly makes the temperature process value come close to the target value (SV), and the temperature is kept constant.

- Two-position control performs control by turning the output value (MV) on or off depending on whether the measured value (PV) is smaller or larger than the target value (SV).
- In two-position control, the value set for the adjustment sensitivity (dead band) becomes valid at the positive side and the negative side each in relation to the target value (SV) as the origin. (When the target value (SV) is 500 and the adjustment sensitivity (dead band) is 100, the upper limit for the adjustment sensitivity (dead band) is 600, and the lower limit is 400.)
- Setting the adjustment sensitivity (dead band) can prevent the control output from being turned on and off repeatedly around the target value (SV).
- In two-position control, the control output cycle setting is ignored.

### ■Two-position control (For standard PID control)

When the proportional gain (KP) is set to 0, two-position control is selected.

For standard PID control, heating control and cooling control are available, and the output state of the output value (MV) is not the same.

According to the position of the measured value (PV) in relation to the sensitivity (dead band), one of the following operations is performed.

- Heating control (backward operation)

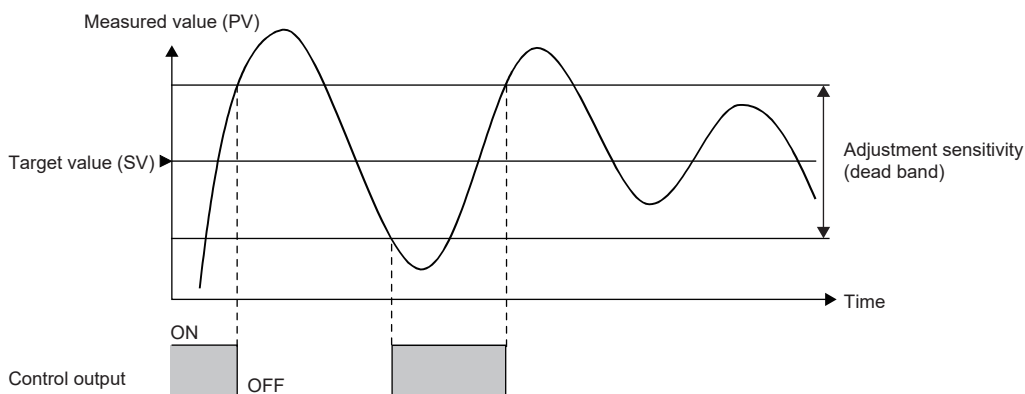

Condition	Output status
Measured value (PV) < Adjustment sensitivity (dead band) lower limit	ON
Measurement value (PV) $\geq$ Adjustment sensitivity (dead band) upper limit	OFF
Adjustment sensitivity (dead band) lower limit $\leq$ Measurement value (PV) < Adjustment sensitivity (dead band) upper limit	The output state of the cycle in the previous cycle is maintained (on during heating, off during cooling)

• Cooling control (forward operation)

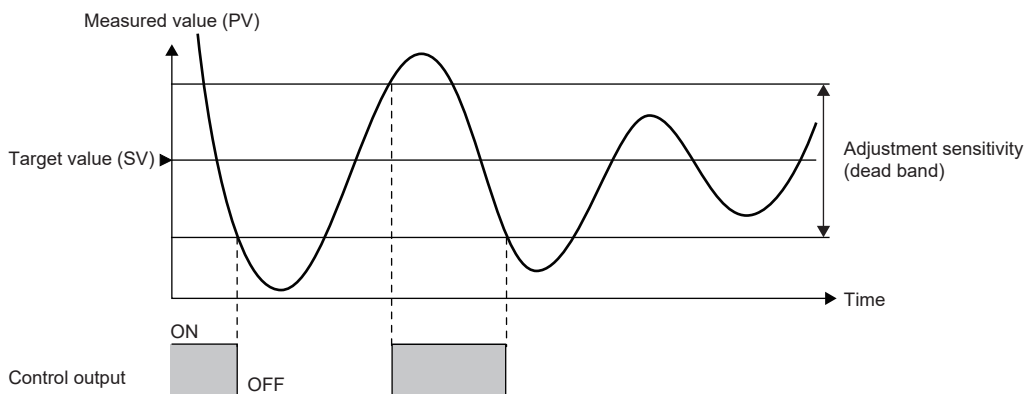

Condition	Output status
Measured value (PV) $\leq$ Adjustment sensitivity (dead band) lower limit	OFF
Measurement value (PV) $>$ Adjustment sensitivity (dead band) upper limit	ON
Adjustment sensitivity (dead band) lower limit $<$ Measurement value (PV) $\leq$ Adjustment sensitivity (dead band) upper limit	The output state of the cycle in the previous cycle is maintained (off during heating, on during cooling)

■ Two-position control (For heating-cooling PID control)

When the heating proportional gain (KPh) is set to 0, two-position control is selected.

The output values are set as either the output value for heating (MVh) turned on/the output value for cooling (MVc) turned off, or the output value for heating (MVh) turned off/the output value for cooling (MVc) turned on.

During two-position control, the value set for the cooling proportional gain (KPc) is ignored.

According to the position of the measured value (PV) in relation to the sensitivity (dead band), one of the following operations is performed.

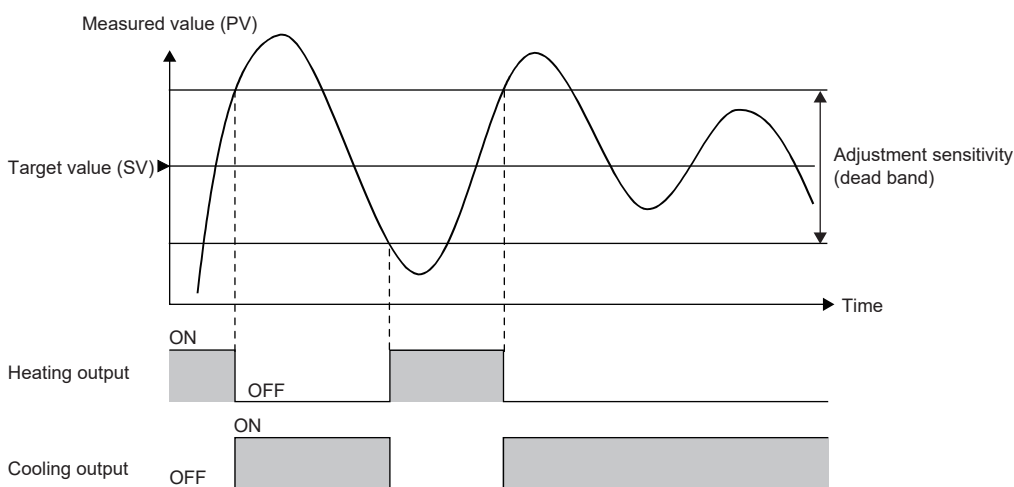

Heating control (backward operation)

Condition	Output status
Measured value (PV) $<$ Adjustment sensitivity (dead band) lower limit	ON
Measurement value (PV) $\geq$ Adjustment sensitivity (dead band) upper limit	OFF
Adjustment sensitivity (dead band) lower limit $\leq$ Measurement value (PV) $<$ Adjustment sensitivity (dead band) upper limit	The output state of the cycle in the previous cycle is maintained (on during heating, off during cooling)

Cooling control (forward operation)

Condition	Output status
Measured value (PV) $<$ Adjustment sensitivity (dead band) lower limit	OFF
Measurement value (PV) $\geq$ Adjustment sensitivity (dead band) upper limit	ON
Adjustment sensitivity (dead band) lower limit $\leq$ Measurement value (PV) $<$ Adjustment sensitivity (dead band) upper limit	The output state of the cycle in the previous cycle is maintained (off during heating, on during cooling)

## ■P control

P control is a control method that determines the output value (MV) in proportion to the deviation (E) between the temperature process value (PV) and target value (SV).

When the value for the integral time (TI) and the differential time (TD) each is set to 0, P control is selected.

### ■P control (For standard PID control)

When the measured value (PV) = the target value (SV), the output value (MV) is 0%.

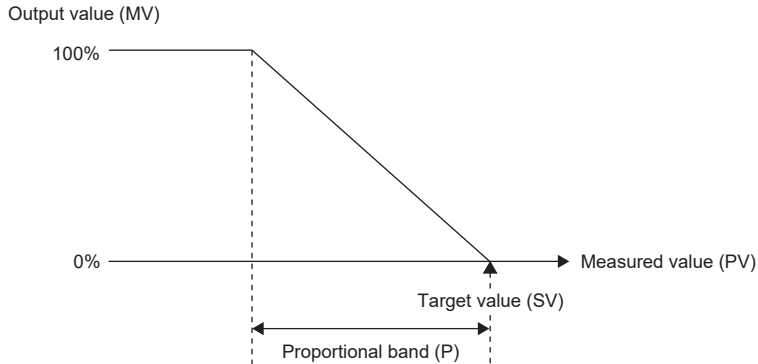

- The value to be actually output is within the output limiter range set by the upper limit output limiter and lower limit output limiter.
- The proportional band (P) is the reciprocal of the proportional gain (KP).

### ■P control (For heating-cooling PID control)

If 0 is set in the overlap/dead band settings when the measured value (PV) is equal to the target value (SV), both the output value for heating (MVh) and the output value for cooling (MVc) are 0%.

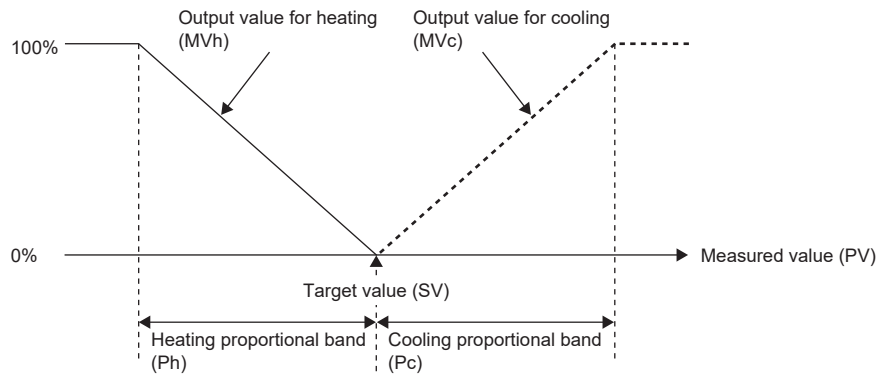

- The value to be actually output is within the output limiter range set by the upper limit output limiter and lower limit output limiter.
- The heating proportional band (Ph) is the reciprocal of the heating proportional gain (KPh), and the cooling proportional band (Pc) is the reciprocal of the cooling proportional gain (KPc).

## ■PI control

PI control is a control method that adds derivative control to P control to correct an offset (remaining deviation) that remains when the temperature is stable. By setting the integral time (TI) properly, the process value (PV) and the target value (SV) can be made to match when the temperature is stable.

When the value for the differential time (TD) is set to 0, PI control is selected.

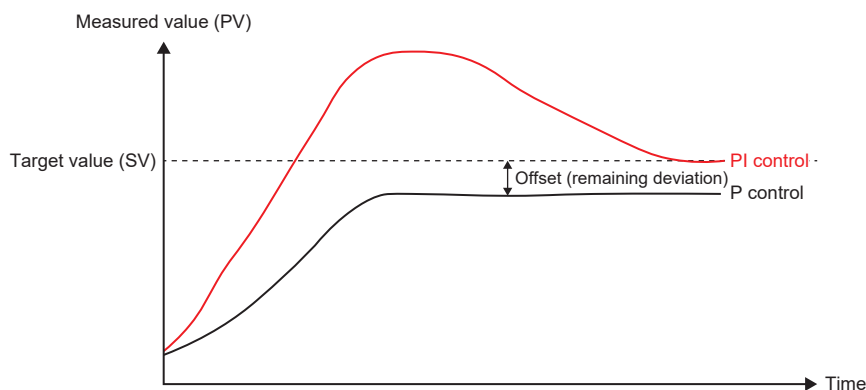



**■PD control**

PD control is a control method that prevents large fluctuation in the measured value (PV) due to such a cause as disturbance by adding differential control to P control.

When the value for the integral time (TI) is set to 0, PD control is selected.

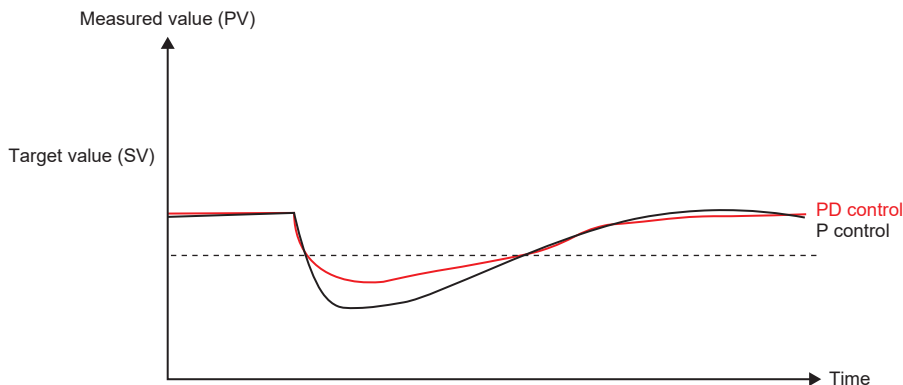

**■PID control**

PID control is a control method that adds differential control to PI control so that the state shifts to a stable state in a short period of time even when a drastic change has occurred.

By setting the derivative time (TD) properly, the control target can be shifted to a stable state in a short period of time.

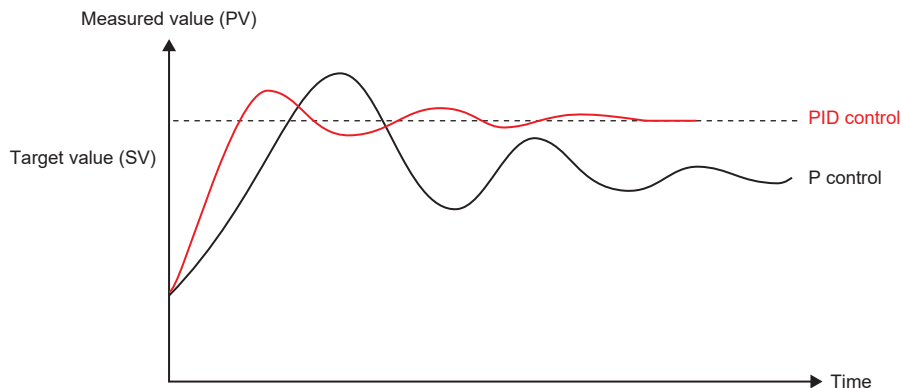

**Proportional gain setting function**

The proportional gain (KP) is set separately for heating and for cooling.

By changing the values for the heating proportional gain (KPh) and cooling proportional gain (KPc), different gradients (heating proportional band (Ph), cooling proportional band (Pc)) can be set.

The reciprocal of the proportional gain is called as the proportional band, and their relation is as follows.

$$\frac{100}{\text{Proportional gain (Kp)}} = \text{Proportional band (P)}$$

## Control output cycle setting function

The control output cycle is a cycle of on/off signals being output from the control output to operate a control device such as a heater and cooler.

Based on the output value calculated by PID control when the control output cycle starts, on signals are output from the control output. After that, until the control output cycle elapses, the output from the control output is turned off.

When the PID control execution command is turned off, PID control stops. Therefore, the output from the control output is turned off regardless of the output status.

### ■The control output cycle and the sampling time cycle match.

When the control output cycle and the sampling time cycle match, the control output is controlled by using the output value calculated by PID control that is executed at the timing at which the control output cycle time elapses.

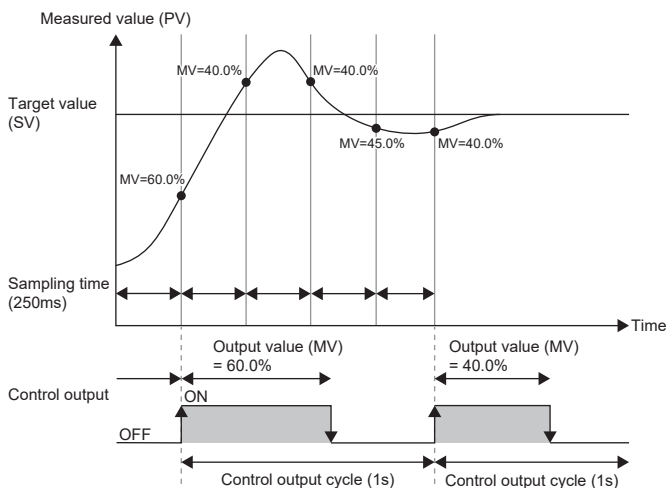

### ■The control output cycle and the sampling time cycle do not match

When the control output cycle and the sampling time cycle do not match, the control output is controlled at the timing of the control output cycle. The output value (MV) used at that time is as follows.

- For the timing applicable when the control output cycle and the sampling time cycle match, in the same way as previously mentioned, use the output value (MV) calculated by PID control that is executed at that timing.
- For the timing applicable when the control output cycle and the sampling time cycle do not match, use the output value (MV) calculated by PID control that has been executed immediately before the said timing.

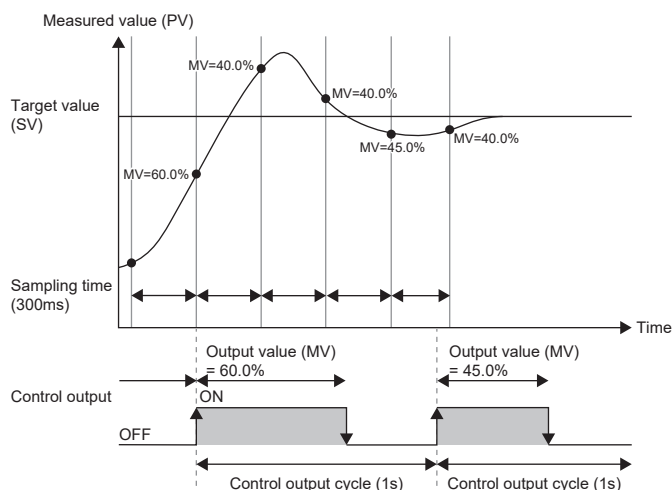

## Auto-tuning function

The auto-tuning function automatically sets the best PID constants.

In the auto tuning, the control output is turned on and off, and PID constants are calculated depending on the cycle and amplitude of hunting that occurs when overshoots and undershoots of the temperature process value (PV) to the target value (SV) are repeated.

For the on/off operation during auto tuning, in the same way as during PID control, the control output is performed based on the value for the cooling control output cycle setting (heating control output cycle setting, cooling control output cycle setting). In addition, during auto tuning, when the upper limit/lower limit output limiters (heating upper limit limiter, cooling upper limit limiter) are set, the output value (MV) is limited according to their settings.

### ■Auto-tuning method and cycle

PID control parameters are calculated by the relay feedback method.

Depending on the control mode, the auto tuning cycle is as follows.

- In standard PID control, two cycles of auto tuning are executed.
- In heating-cooling PID control, normally two cycles are executed. When the ambient temperature setting function is enabled, 2.5 cycles are executed.

When auto tuning is executed, standard PID control and heating-cooling PID control each calculate the following by the relay feedback method.

Standard PID control (forward operation, backward operation)	Heating-cooling PID control
<ul style="list-style-type: none"> <li>• Proportional gain</li> <li>• Integral time</li> <li>• Differential time</li> </ul>	<ul style="list-style-type: none"> <li>• Heating proportional gain</li> <li>• Cooling proportional gain</li> <li>• Integral time</li> <li>• Differential time</li> </ul>

## ■Auto-tuning calculation formula

Operation expression*1	Item	Operation expression usage timing
$K_p = 0.588 \times \frac{4}{\pi(Y_{\max} - Y_{\min})}$	Proportional gain	<ul style="list-style-type: none"> <li>• Heating control of standard PID control</li> <li>• Cooling control of PID control</li> </ul>
	Heating proportional gain	<ul style="list-style-type: none"> <li>• At the 3rd cycle of heating-cooling PID control (when the ambient temperature setting is enabled, target value <math>\geq</math> ambient temperature)</li> </ul>
	Cooling proportional gain	<ul style="list-style-type: none"> <li>• Up to the 3rd cycle of heating-cooling PID control (when the ambient temperature setting is enabled, target value <math>&lt;</math> ambient temperature)</li> </ul>
$K_{ph} = 0.588 \times \frac{4}{\pi(Y_{\max} - Y_{\min})} \times \frac{SV - Y_{\min}}{(Y_{\max} - SV) + (SV - Y_{\min})}$	Heating proportional gain	<ul style="list-style-type: none"> <li>• Heating-cooling PID control (when the ambient temperature setting is disabled)</li> <li>• Up to the 2nd cycle of heating-cooling PID control (when the ambient temperature setting is enabled, target value <math>\geq</math> ambient temperature)</li> <li>• Up to the 2nd cycle of heating-cooling PID control (when the ambient temperature setting is enabled, target value <math>&lt;</math> ambient temperature)</li> </ul>
	Cooling proportional gain	<ul style="list-style-type: none"> <li>• Heating-cooling PID control (when the ambient temperature setting is disabled)</li> <li>• Up to the 2nd cycle of heating-cooling PID control (when the ambient temperature setting is enabled, target value <math>\geq</math> ambient temperature)</li> <li>• Up to the 2nd cycle of heating-cooling PID control (when the ambient temperature setting is enabled, target value <math>&lt;</math> ambient temperature)</li> </ul>
$K_{pc} = 0.588 \times \frac{4}{\pi(Y_{\max} - Y_{\min})} \times \frac{Y_{\max} - SV}{(Y_{\max} - SV) + (SV - Y_{\min})}$	Cooling proportional gain	<ul style="list-style-type: none"> <li>• Heating-cooling PID control (when the ambient temperature setting is disabled)</li> <li>• Up to the 2nd cycle of heating-cooling PID control (when the ambient temperature setting is enabled, target value <math>\geq</math> ambient temperature)</li> <li>• Up to the 2nd cycle of heating-cooling PID control (when the ambient temperature setting is enabled, target value <math>&lt;</math> ambient temperature)</li> </ul>
$T_i = 0.5 \times (T_{\text{Final}} - T_{\text{Init}}) + 1000$	Integral time	<ul style="list-style-type: none"> <li>• Heating control of standard PID control</li> <li>• Cooling control of PID control</li> <li>• Heating-cooling PID control (when the ambient temperature setting is disabled)</li> <li>• Heating-cooling PID control (when the ambient temperature setting is enabled, target value <math>\geq</math> ambient temperature)</li> <li>• Heating-cooling PID control (when the ambient temperature setting is enabled, target value <math>&lt;</math> ambient temperature)</li> </ul>
$T_d = 0.125 \times (T_{\text{Final}} - T_{\text{Init}}) + 1000$	Differential time	<ul style="list-style-type: none"> <li>• Heating control of standard PID control</li> <li>• Cooling control of PID control</li> <li>• Heating-cooling PID control (when the ambient temperature setting is disabled)</li> <li>• Heating-cooling PID control (when the ambient temperature setting is enabled, target value <math>\geq</math> ambient temperature)</li> <li>• Heating-cooling PID control (when the ambient temperature setting is enabled, target value <math>&lt;</math> ambient temperature)</li> </ul>

\*1 KP: Proportional gain, KPh: Heating proportional gain, KPC: Cooling proportional gain,  $\pi$ : Ratio of a circle's circumference to its diameter, Ymax: Maximum process value, Ymin: Minimum process value, Ti: Integral time (s), Td: Derivative time (s), T<sub>Int</sub>: Cycle start time (ms), T<sub>Final</sub>: Cycle end time (ms)

### ■ Output value during auto-tuning

The following figures show output values (MVs) during auto tuning in standard PID control and heating-cooling PID control using timing charts.

- Heating control (backward operation) of standard PID control

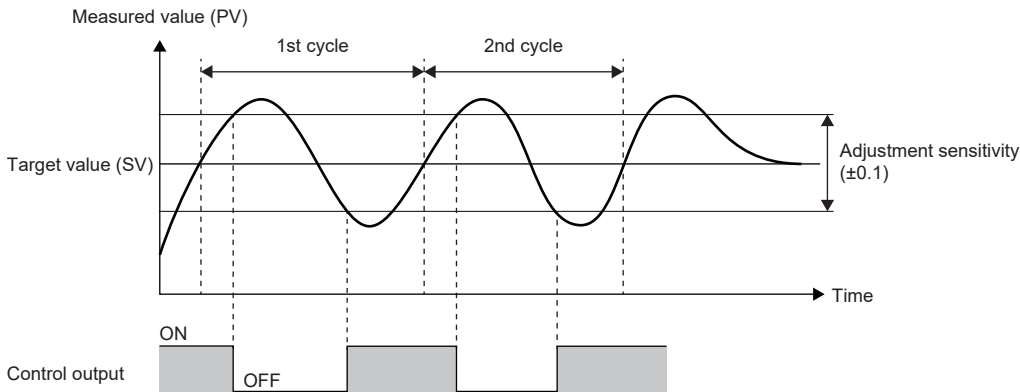

- Cooling control (forward operation) of standard PID control

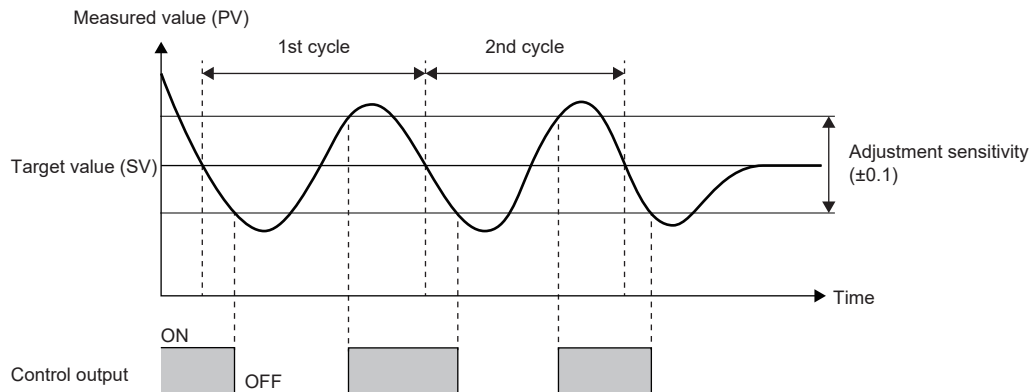

- Heating-cooling PID control (ambient temperature setting function disabled)

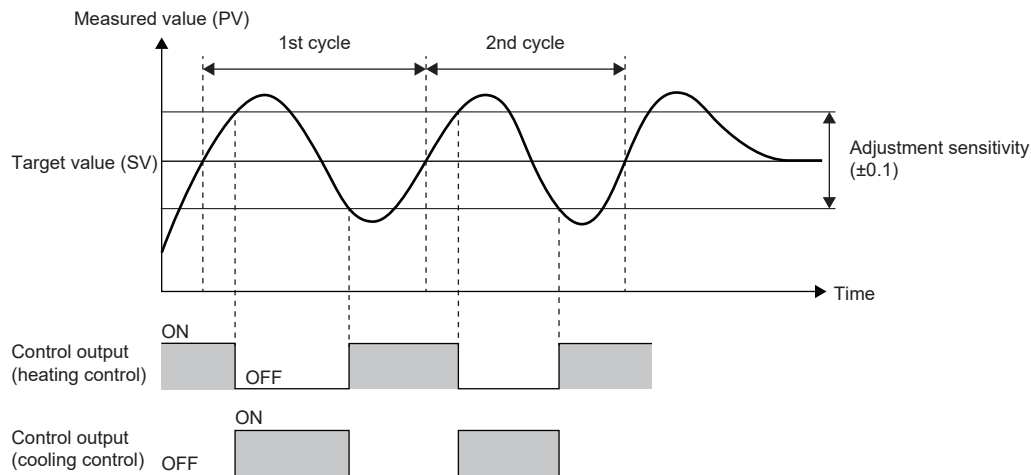

- Heating-cooling PID control (ambient temperature setting function enabled, target value  $\geq$  ambient temperature)

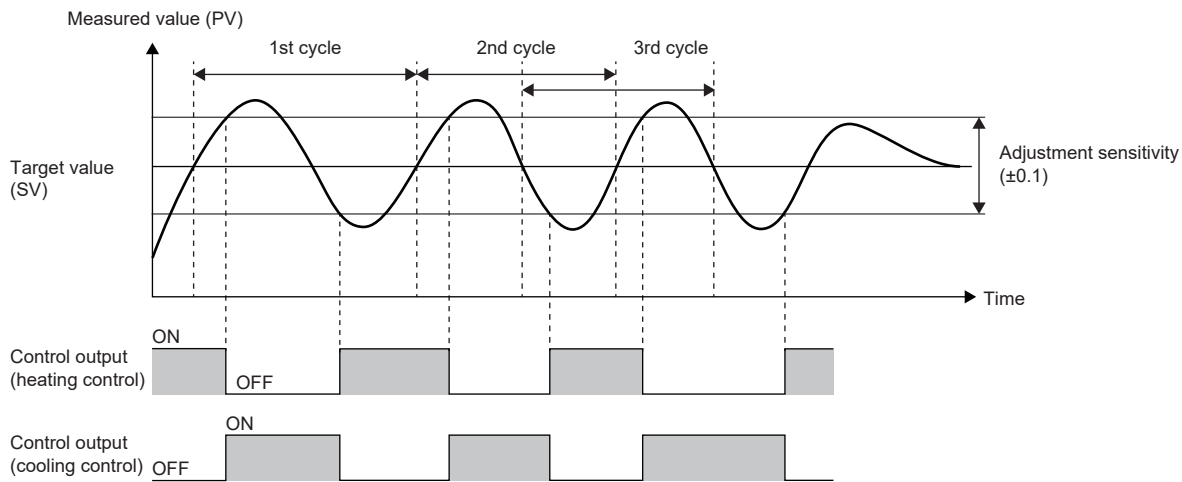

When the ambient temperature setting function is enabled, auto tuning is completed after execution of 2.5 cycles. The third cycle starts in the middle of the second cycle, and ends completely when 2.5 cycles are executed.

- Heating-cooling PID control (ambient temperature setting function enabled, target value  $<$  ambient temperature)

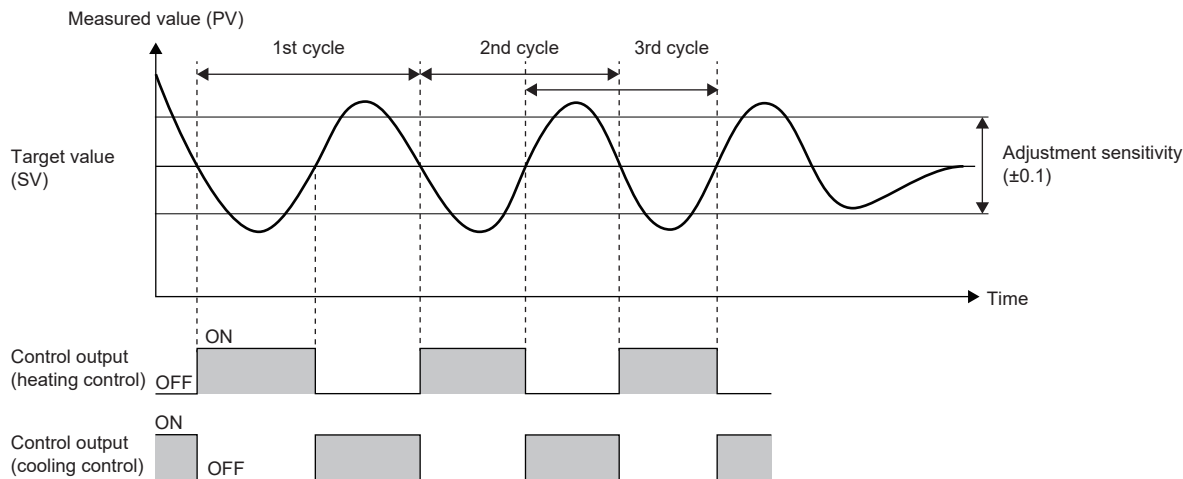

When the ambient temperature setting function is enabled, auto tuning is completed after execution of 2.5 cycles. The third cycle starts in the middle of the second cycle, and ends completely when 2.5 cycles are executed.

## ■ Execution and stop conditions for auto tuning

The following table shows the execution and stop conditions for using auto tuning.

Execution condition	Stop condition
<ul style="list-style-type: none"> <li>• "To Use or Not to Use Auto-tuning" is set to "Auto tuning used".</li> <li>• "PID Control Execution Command" is set to "PID control executed".</li> <li>• The upper limit output limiter/heating upper limit output limiter/cooling upper limit output limiter is set to 1 (0.1%) or larger.</li> <li>• The lower limit output limiter is set to 999 (99.9%) or smaller.</li> </ul>	<ul style="list-style-type: none"> <li>• When "PID Control Execution Command" is set to "PID control not executed" (Stopped)</li> <li>• When the target value (SV) is changed</li> <li>• When the value for the upper limit output limiter/lower limit output limiter is changed</li> <li>• When auto tuning does not end even after approximately two hours have elapsed after its start</li> <li>• When the sampling time is changed</li> <li>• When the cooling control output cycle setting, heating control output cycle setting, or cooling control output cycle setting is changed</li> <li>• When the module operation status turns into the PAUSE state</li> </ul>

## ■ Related flag timings

The following figures show the related flag timings based on timing charts.

- For normal execution

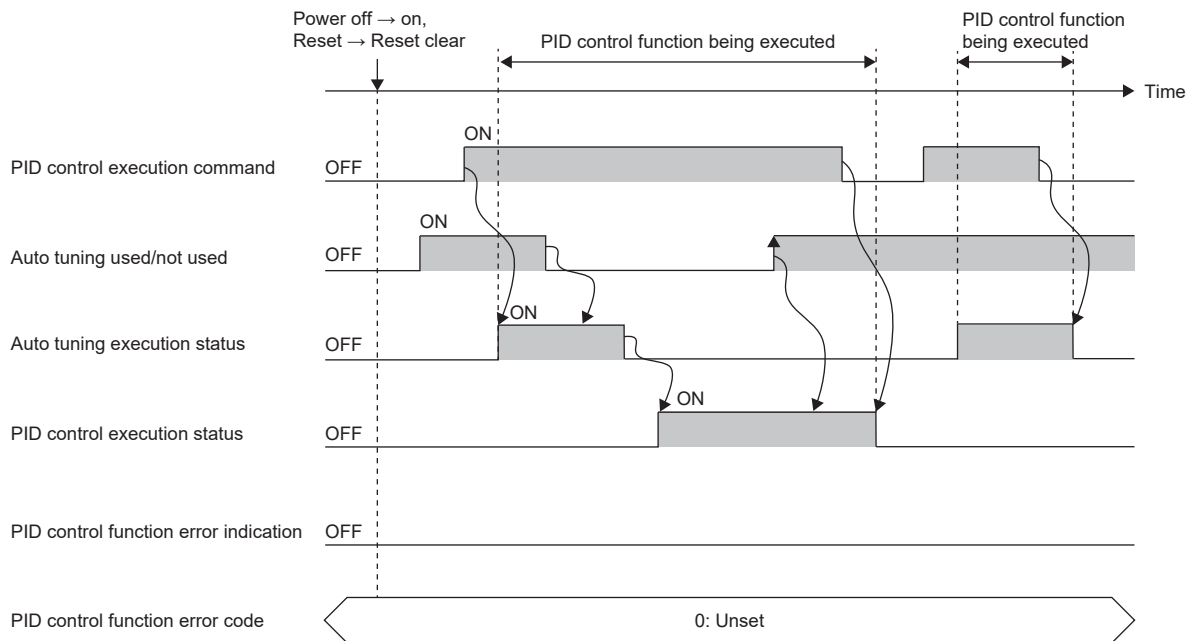

- (1) When the user writes on to "To Use or Not to Use Auto-tuning" in advance and writes on to "PID Control Execution Command", the system sets on to "Auto-tuning Execution Status".
- (2) While auto tuning is being executed, even if the user writes off to "To Use or Not to Use Auto-tuning", "Auto-tuning Execution Status" remains to be on, and the value for "To Use or Not to Use Auto-tuning" is ignored.
- (3) When auto tuning is completed successfully, the system sets off to "Auto-tuning Execution Status" and on to "PID Control Execution Status".
- (4) While the PID control function is being executed, even if the user writes on, off, and on in sequence to "To Use or Not to Use Auto-tuning", "Auto-tuning Execution Status" remains to be off, and the value for "To Use or Not to Use Auto-tuning" is ignored.
- (5) When the user writes off to "PID Control Execution Command", the PID control function ends, and the system sets off to "PID Control Execution Status".
- (6) When the user writes off to "PID Control Execution Command" during auto tuning, PID control ends, and the system sets off to "Auto-tuning Execution Status".

- For execution in the event of an error

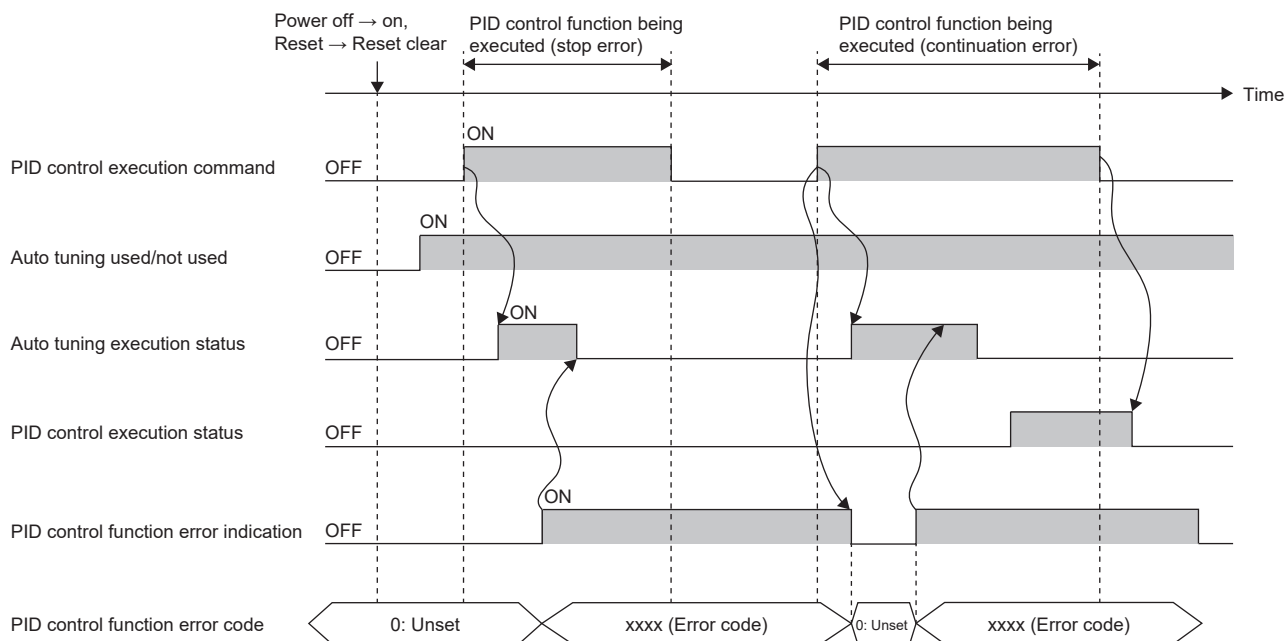

(1) If a PID control stop error occurs while auto tuning is being executed, the system sets the following and stops auto tuning. (Since auto tuning is not completed, "PID Control Execution Status" is not set to on.)

- Set on to "PID Control Function Error Display".
- Set the corresponding error code to "PID Control Function Error Code".
- Set off to "Auto-tuning Execution Status".

(2) Since the system does not set off to "PID Control Execution Command", the user needs to write off when executing auto tuning again.

(3) When the user writes on to "PID Control Execution Command", the system sets the following and executes auto tuning again.

- Set off to "PID Control Function Error Display".
- Set 0 to "PID Control Function Error Code".

(4) If a PID control continuation error occurs while auto tuning is being executed, the system sets the following, but auto tuning continues without changing "Auto-tuning Execution Status".

- Set on to "PID Control Function Error Display".
- Set the corresponding error code to "PID Control Function Error Code".
- When auto tuning is completed, the system sets off to "Auto-tuning Execution Status" and on to "PID Control Execution Status" to execute the PID control function.

(5) Since the PID control function is executed normally, the user sets off to "PID Control Execution Command" to end the PID control function.

## ■Precautions

- Even when "To Use or Not to Use Auto-tuning" is set to "Auto tuning used" while the PID control function being executed, auto tuning is not executed.
- When the ambient temperature setting is enabled, if the relation (which is higher) between the target value (SV) and the ambient temperature setting at the start of PID control (at the start of auto tuning) is changed after completion of auto tuning, the accuracy of PID control goes down.
- When the ambient temperature setting is enabled, even if the relation (which is higher) between the target value (SV) and the ambient temperature setting is changed during auto tuning, the change is ignored. The change in the ambient temperature setting becomes valid after completion of auto tuning (during PID control).
- When PID control is stopped by setting on and off to the PID control execution command, the devices for the following parameters are cleared.
  - Set off to the control output.
  - Clear the output value (MV), output value for heating (MVh), and output value for cooling (MVc) to 0.
  - Set off to the temperature rise judgment flag.
  - Set off to the PID control execution status.
  - Set off to the auto tuning execution status.



## Error display function

If an error occurs while PID control or auto-tuning is being executed, the error status and error code are stored into the devices. For error code details, refer to the following.

☞ Page 641 Troubleshooting

When an error occurs, "1: Error occurrence" is written to the device set in the "PID Control Function Error Display" parameter, and the error code is written to the device set in the "PID Control Function Error Code" parameter.

An error cannot be checked if no device is set to the parameters.

When an error has already occurred, and another error occurs with the error code written into the device set in "PID Control Function Error Code", the error code already stored into the device will be overwritten.

The error status set to "PID Control Function Error Display" and "PID Control Function Error Code" can be cleared by any of the following methods.

- Set "PID Control Execution Command" to "1: PID control executed".
- Rewrite the values in the devices directly.
- If the device set in each parameter is not a latch device, power off or reset the CPU module.

## Overlap/dead band function

The temperature where the cooling control output starts is shifted; therefore, select which of the control stability or energy saving is to be prioritized.

### Point

In heating-cooling PID control, the temperature process value (PV) significantly changes due to slight heating or cooling control output when the heat produced by a controlled object and natural cooling are being balanced. Consequently, excessive output may be performed.

### ■Overlap

Overlap refers to the temperature area where both heating control and cooling control are performed. In the temperature area where both heating and cooling outputs overlap, both of the output negate each other, thus the control gain becomes moderate. Consequently, the change amount in the temperature process value (PV) for the output becomes small, improving control stability.

When setting an overlapping area, set a negative value in "Overlap/Dead Band Setting".

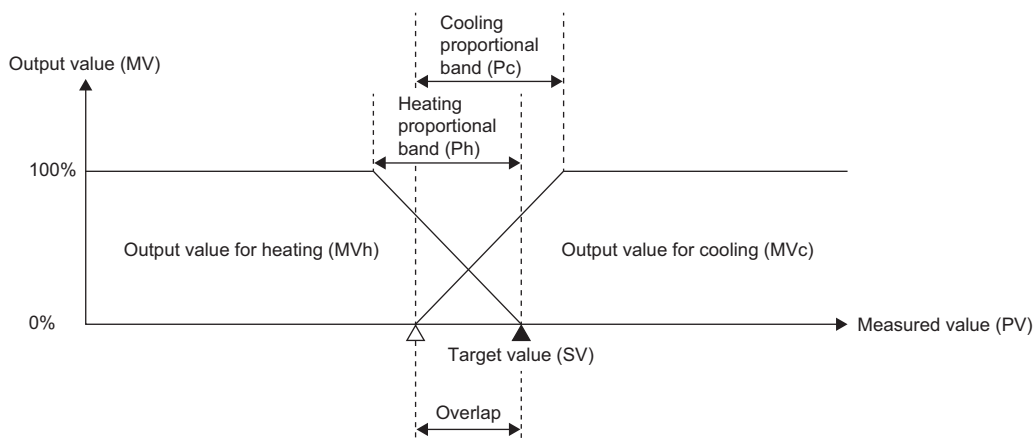

### ■Dead band

Dead band refers to the temperature area where neither heating control output nor cooling control output is performed. When the temperature process value (PV) is stable within this area, output is not performed for the slight change in the temperature, contributing to energy saving.

When setting a dead band area, set a positive value in "Overlap/Dead Band Setting".

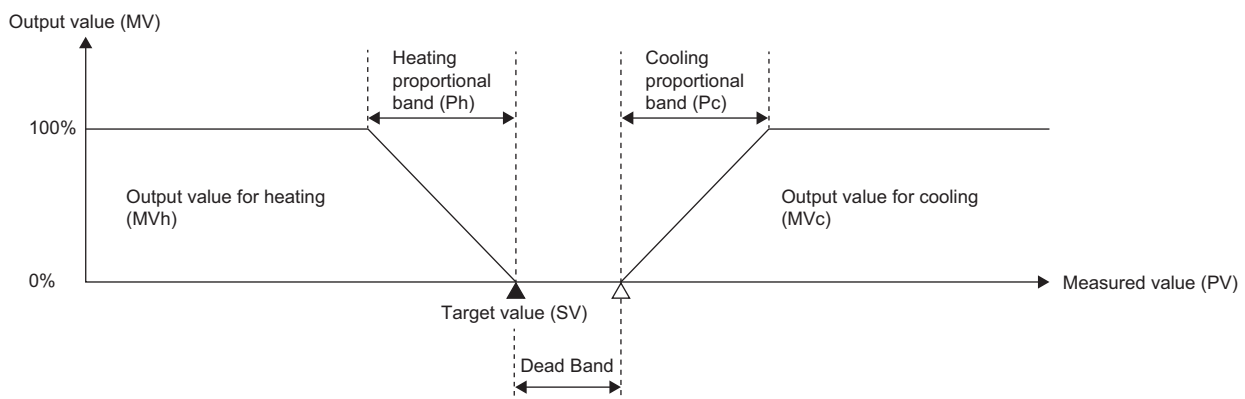

## Output limiter function

The output limiter is a function that sets the upper and lower limit values if outputting the output value (MV) calculated using PID operations to an external device.

It is disabled only when executing two-position control.

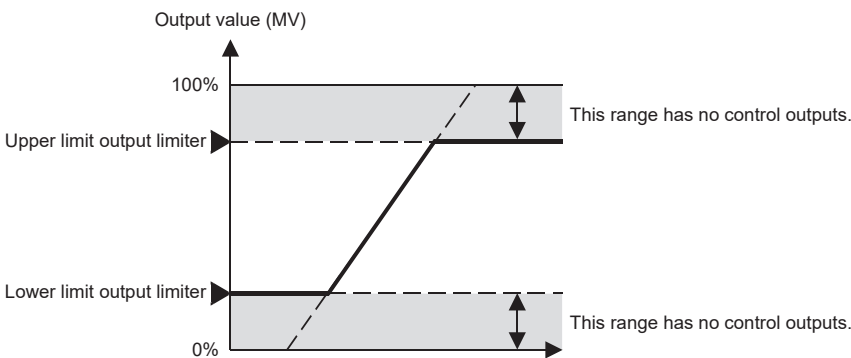

## Output change ratio limiter function

The output change ratio limiter is a function that limits the amount of change in the output value (MV) per unit time (1s). Control outputs are limited using the output change rate that has been set.

For a control target that goes out of control due to a sudden change in the output or a control target in which a large current flows, setting the output variation limiter is effective.

When the target value (SV) is changed, the output value (MV) does not change suddenly, and outputs are made based on the set gradient. When the set value is 0, this function is disabled.

The output value (MV) limited by the output change ratio limiter function can be obtained by the following formula.

$$\text{Output value (MV)} = (\text{Previous output value (MV)} \pm \text{Output change ratio limiter (\%)} \times (\text{Sampling time (ms)} \div 1000)$$

### ■When the output change ratio limiter is effective

The output change ratio limiter is effective in the following cases.

- If the output value (MV) starts from 100% at the start of control (When there is a problem with a 100% sudden change)
- If the output value (MV) changes suddenly due to a change in the target value (SV)

**Ex.**

When the rise of the output change ratio limiter is effective

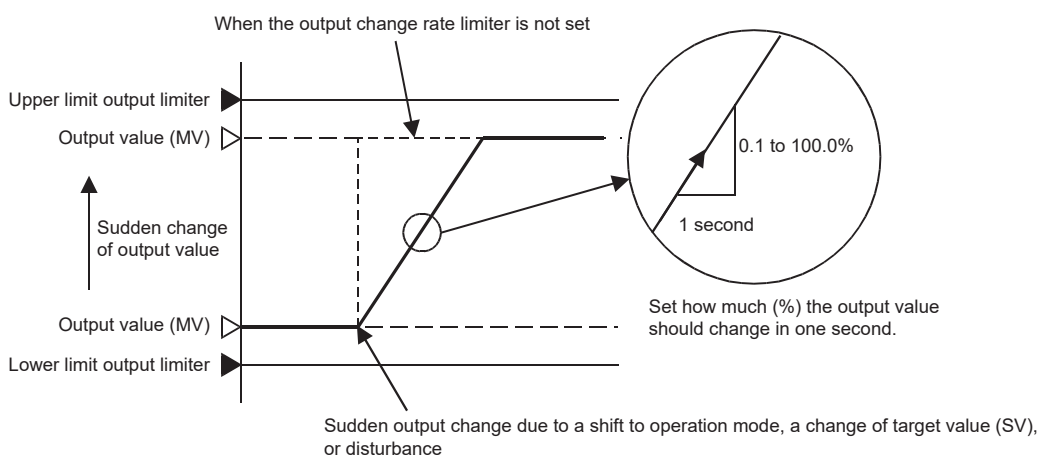

When the target value (SV) is changed significantly, the output does not change suddenly, and outputs are made based on the set gradient.

### ■Precautions

- Reducing the output change ratio limiter value (reducing the gradient) slows the control response. In addition, the effect of differentiation is lost.
- The output change rate limiter is disabled when executing two-position control.

## Temperature rise completion judgment function

The temperature rise completion judgment is a function that judges whether the temperature process value (PV) is within the temperature rise completion range. Judgment is made per sampling time.

The upper limit and lower limit values for the temperature rise completion range can be found by the following formula.

Temperature rise completion range upper value: Target value (SV) + Temperature rise completion range setting value

Temperature rise completion range lower limit: Target value (SV) - Temperature rise completion range setting value

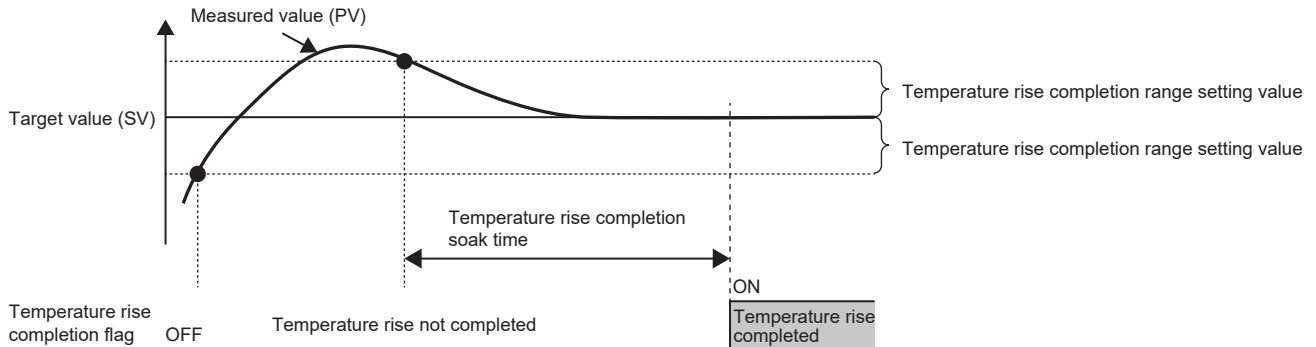

## Ambient temperature setting function

When the ambient temperature setting value is higher than or equal to/lower than the target value (SV), this function prevents unnecessary execution of heating control or cooling control by setting either the output value for heating (MVh) or the output value for cooling (MVc) to 0.

### Point

This function prevents heating control and cooling control in the following cases.

- When the ambient temperature (room temperature) is equal to or lower than the target value (SV), without executing cooling control, the measured value (PV) goes down to the target value (SV).
- When the ambient temperature (room temperature) is higher than the target value (SV), without executing heating control, the measured value (PV) goes up to the target value (SV).

### Control output when the ambient temperature setting function is enabled/disabled

The following figures show the control outputs when the ambient temperature setting function is enabled and disabled by using timing charts.

- When the ambient temperature setting function is disabled

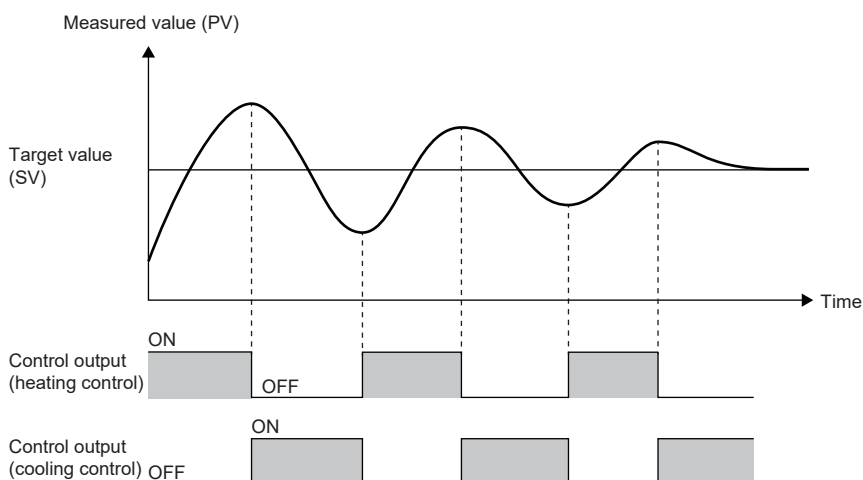

- When the ambient temperature setting function is enabled, and the ambient temperature setting value is equal to or lower than the target value

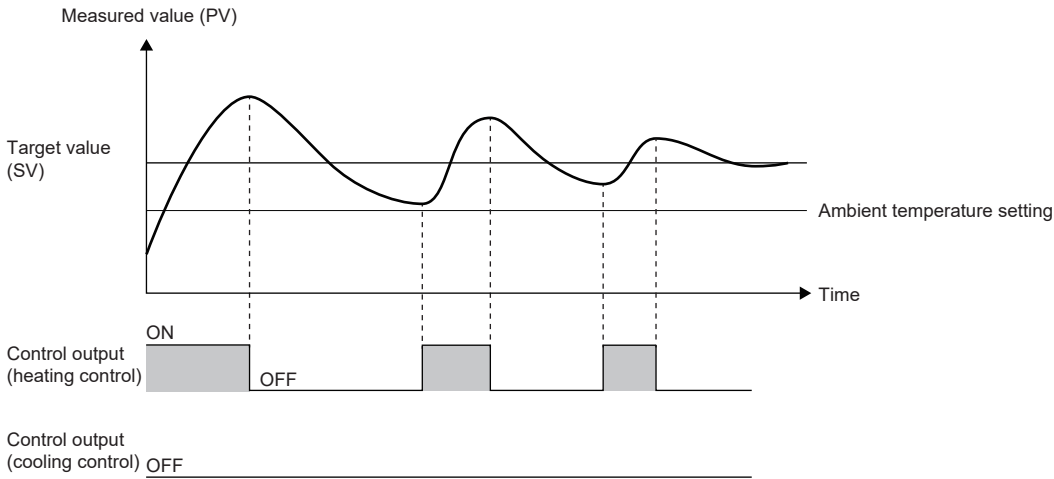

- (1) Cooling control is not executed because the ambient temperature setting value (room temperature) is equal to or lower than the target value (SV) and the measured value (PV) decreases without cooling. (Always off)
- (2) Since cooling is not performed, the fall of the measured value (PV) becomes gentler compared to the fall when the ambient temperature setting function is disabled.

- When the ambient temperature setting function is enabled, and the ambient temperature setting value is higher than the target value

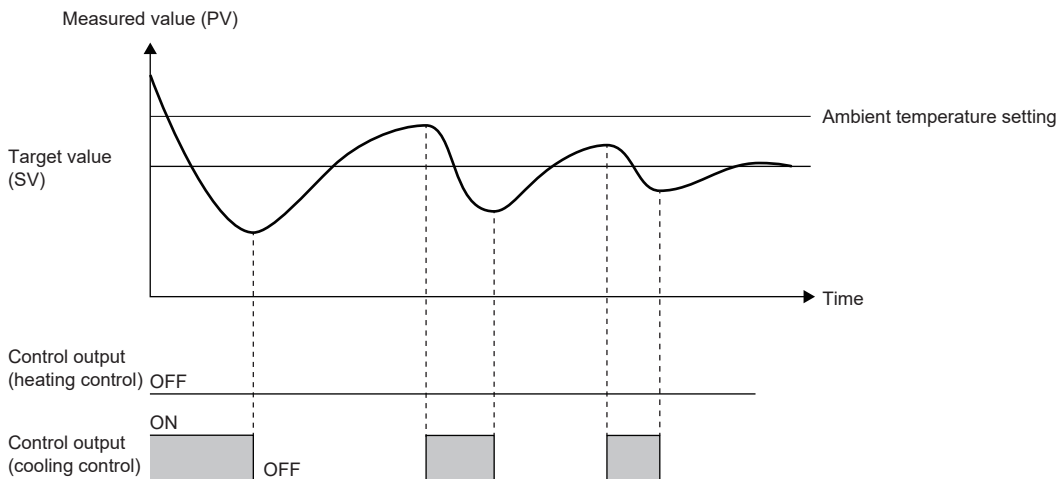

- (1) Heating control is not executed because the ambient temperature setting value (room temperature) is higher than the target value (SV) and the measured value (PV) increases without heating. (Always off)
- (2) Since heating is not performed, the rise of the measured value (PV) becomes gentler compared to the rise when the ambient temperature setting function is disabled.

## ■Precautions

- When the ambient temperature setting function is enabled, the overlap/dead band settings are disabled.
- When the ambient temperature setting function is enabled, if the relation (which is higher) between the target value and the ambient temperature setting is changed after setting "PID Control Execution Command" to "1: PID control executed", the accuracy of PID control goes down.

# Setting and program examples

This section shows parameter setting examples and program examples when using the heating-cooling PID control function.

## Setting example 2

When "Control mode" is "Standard PID control mode", after auto tuning starts and ends completely, PID control using the obtained control parameters is performed.

### System configuration

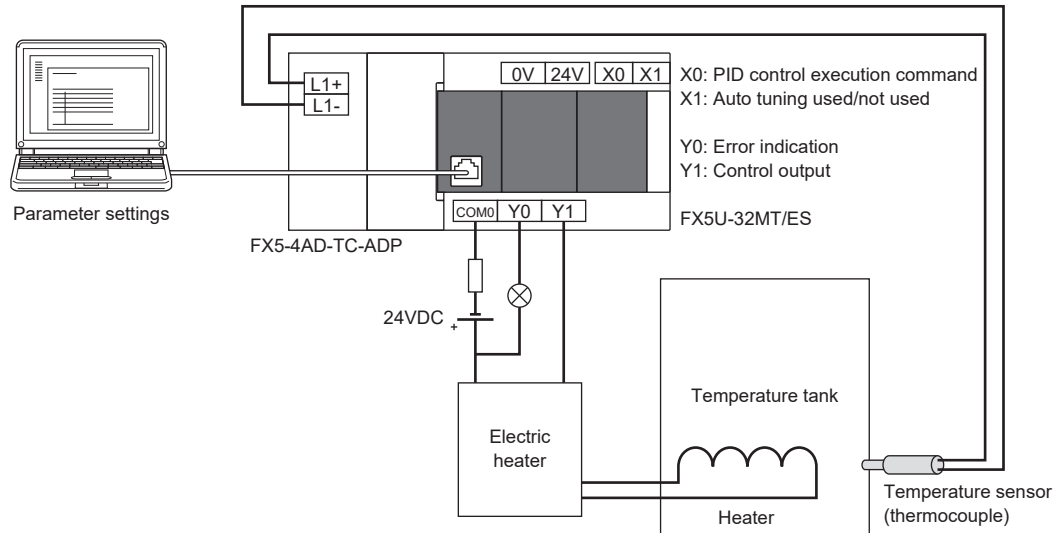

### Operation example

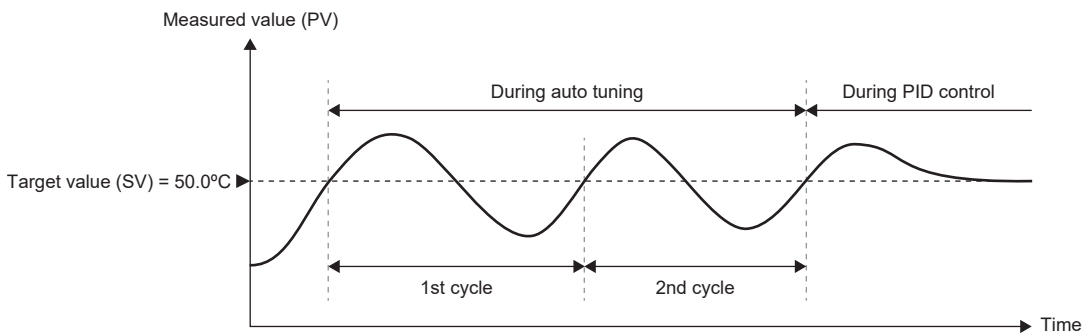

#### During auto tuning (when the upper limit output limiter is 90%)

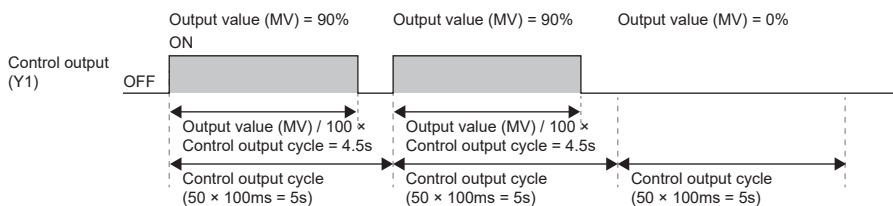

#### During PID control

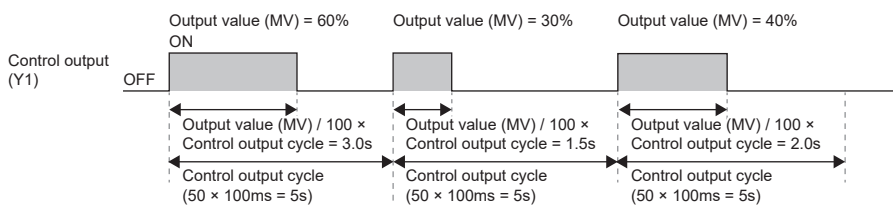

Parameter setting example

Setting item		Setting value	Device indirect specification	
Basic Settings	To Use or Not to Use PID Control Function		Use	
	Control Mode Selection		Standard PID Control	
	Direct Action/Reverse Action Selection		Reverse Action	
	Target Value (SV)		500	
	Process Value (PV)		—	
	Output Value (MV)		—	
	Heating Output Value (MVh)		—	
	Cooling Output Value (MVc)		—	
	Control Parameter	Proportional Gain (KP)	Not used	D200
		Heating Proportional Gain (KPh)	—	—
		Cooling Proportional Gain (K Pc)	—	—
		Integral Time (TI)	Not used	D203
		Derivative Time (TD)	Not used	D204
	Sampling Time (Ts)		10[×10ms]	Not used
	Operation Cycle	Control Output Cycle	50[×100ms]	Not used
		Heating Control Output Cycle	—	—
		Cooling Control Output Cycle	—	—
	Control Output		—	Y1
	Control Output (for Cooling Control)		—	—
	PID Control Execution Command		—	X0
	To Use or Not to Use Auto-tuning		—	X1
	PID Control Execution Status		—	M0
	Auto-tuning Execution Status		—	M1
PID Control Function Error Display		—	Y0	
PID Control Function Error Code		—	D10	
Application Settings	2-position Control Function	Adjustment sensitivity (dead band)	10	
	Overlap/Dead Band Setting		—	
	Output Limiter Function	Upper Limit Output Limiter	900[×0.1%]	Not used
		Lower Limit Output Limiter	0[×0.1%]	Not used
		Heating Upper Limit Output Limiter	—	—
		Cooling Upper Limit Output Limiter	—	—
	Output Variation Rate Limiter Function	Output Variation Rate Limiter	0[×0.1%/s]	Not used
	Temperature Rise Completion Judgement Function	Temperature Rise Judgment Flag	—	M3
		Temperature Rise Completion Range	50	Not used
		Temperature Rise Completion Soak Time	5[s]	Not used
	Ambient Temperature Setting		—	—

## Program examples

- Device setting example

Item	Device indirect specification	Description
A/D conversion enable/disable setting (CH1)	SM6301	FX5-4AD-TC-ADP(CH1) A/D conversion enable/disable setting (0: Enabled, 1: Disabled)
Auto tuning completion flag	M2	Flag that turns on when auto tuning starts and ends completely

- Program examples

Set use permission for the FX5-4AD-TC-ADP(CH1), which was set as the process value (SD6300) when the state was changed from STOP to RUN. After PID control starts, turn on the auto tuning completion flag when auto tuning is completed. After writing the parameter settings and program to the CPU module, turn X1 (Auto tuning used/not used) on and turn X0 (PID control execution command) on, and auto tuning + PID control can be executed.

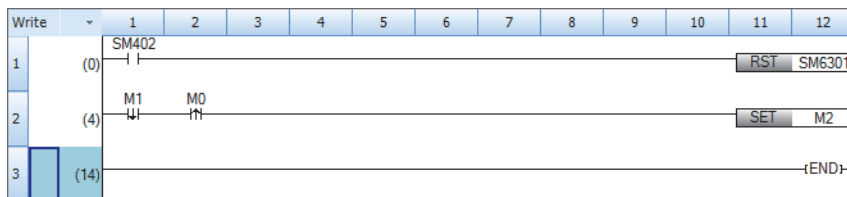

## Setting example 3

When "Control mode" is "Standard PID control mode", after auto tuning starts and ends completely, PID control using the obtained control parameters is performed. After auto tuning is completed, perform conversion to the voltage value (0 to 5V) to be output to the control target by using the output value (MV).

## System configuration

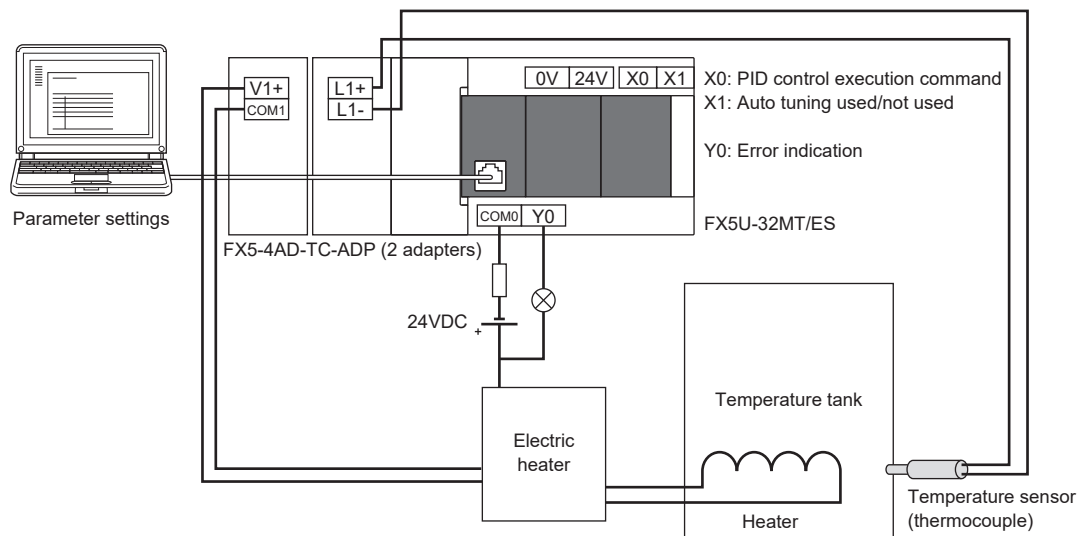



## Operation example

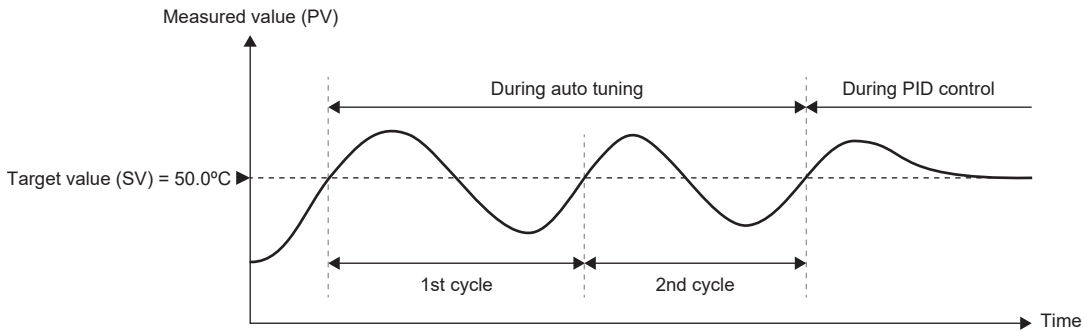

### During auto tuning (when the upper limit output limiter is 90%)

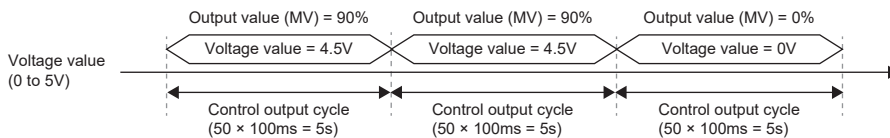

### During PID control

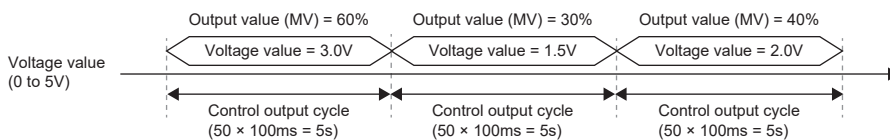

## Parameter setting example

Setting item	Setting value	Device indirect specification		
Basic Settings	To Use or Not to Use PID Control Function	Use	—	
	Control Mode Selection	Standard PID Control	—	
	Direct Action/Reverse Action Selection	Reverse Action	—	
	Target Value (SV)	500	D0	
	Process Value (PV)	—	SD6300	
	Output Value (MV)	—	D1	
	Heating Output Value (MVh)	—	—	
	Cooling Output Value (MVc)	—	—	
	Control Parameter	Proportional Gain (KP)	Not used	D200
		Heating Proportional Gain (KPh)	—	—
		Cooling Proportional Gain (KPC)	—	—
		Integral Time (TI)	Not used	D203
		Derivative Time (TD)	Not used	D204
	Sampling Time (Ts)	10[×10ms]	Not used	
	Operation Cycle	Control Output Cycle	50[×100ms]	Not used
		Heating Control Output Cycle	—	—
		Cooling Control Output Cycle	—	—
	Control Output	—	Not used	
	Control Output (for Cooling Control)	—	—	
PID Control Execution Command	—	X0		
To Use or Not to Use Auto-tuning	—	X1		
PID Control Execution Status	—	M0		
Auto-tuning Execution Status	—	M1		
PID Control Function Error Display	—	Y0		
PID Control Function Error Code	—	D10		

Setting item			Setting value	Device indirect specification
Application Settings	2-position Control Function	Adjustment sensitivity (dead band)	10	Not used
	Overlap/Dead Band Setting		—	—
	Output Limiter Function	Upper Limit Output Limiter	900[×0.1%]	D410
		Lower Limit Output Limiter	0[×0.1%]	D411
		Heating Upper Limit Output Limiter	—	—
		Cooling Upper Limit Output Limiter	—	—
	Output Variation Rate Limiter Function	Output Variation Rate Limiter	0[×0.1%/s]	D414
	Temperature Rise Completion Judgement Function	Temperature Rise Judgment Flag	—	M3
		Temperature Rise Completion Range	50	D415
		Temperature Rise Completion Soak Time	5[s]	D416
Ambient Temperature Setting		—	—	

## ■ Program examples

### • Device setting example

Item	Device indirect specification	Description
A/D conversion enable/disable setting (CH1)	SM6301	FX5-4AD-TC-ADP(CH1) A/D conversion enable/disable setting (0: Enabled, 1: Disabled)
D/A conversion enable/disable setting	SM6660	FX5-4DA-ADP(CH1) D/A conversion enable/disable setting (0: Enabled, 1: Disabled)
D/A output enable/disable setting	SM6661	FX5-4DA-ADP(CH1) D/A output enable/disable setting (0: Enabled, 1: Disabled)
Output range setting	SD6665	FX5-4DA-ADP(CH1) output range setting (setting value 1: 0 to 5V)
Real number for division of output value (MV)	D20	Since the unit of the output value (MV) is ×0.1%, store K1000 using a real number value.
	D21	
For conversion of output value (MV) into digital value	D22	Since the voltage value (0 to 5V) is output in this program, store the maximum digital value K16000 using a real number value.
	D23	
Auto tuning completion flag	M2	Flag that turns on when auto tuning starts and ends completely
Digital value (CH1)	SD6660	FX5-4DA-ADP(CH1) digital value
Analog output value monitor (CH1)	SD6662	FX5-4DA-ADP(CH1) analog output value monitor
Output value (MV) (real number)	D24	Store the output value (MV) (after conversion to real number).
	D25	
Output value (MV) (0.00 to 1.00)	D26	Store the value obtained after conversion of the output value (MV) from a value in the range 0 to 1000 to a value in the range 0.00 to 1.00.
	D27	
Digital value (real number)	D28	Store the digital value obtained by calculation using a real number value.
	D29	

• Program example

Set use permission for the FX5-4AD-TC-ADP(CH1), which was set as the process value (SD6300) when the state was changed from STOP to RUN, and configure settings for the FX5-4DA-ADP(CH1). After PID control starts, perform conversion to the digital value (0 to 16000) to be output to the control target by using the output value (MV), and obtain the analog output value (SD6662). Turn on the auto tuning completion flag when auto tuning is completed.

After writing the parameter settings and program to the CPU module, turn X1 (Auto tuning used/not used) on and turn X0 (PID control execution command) on, and auto tuning + PID control can be executed.

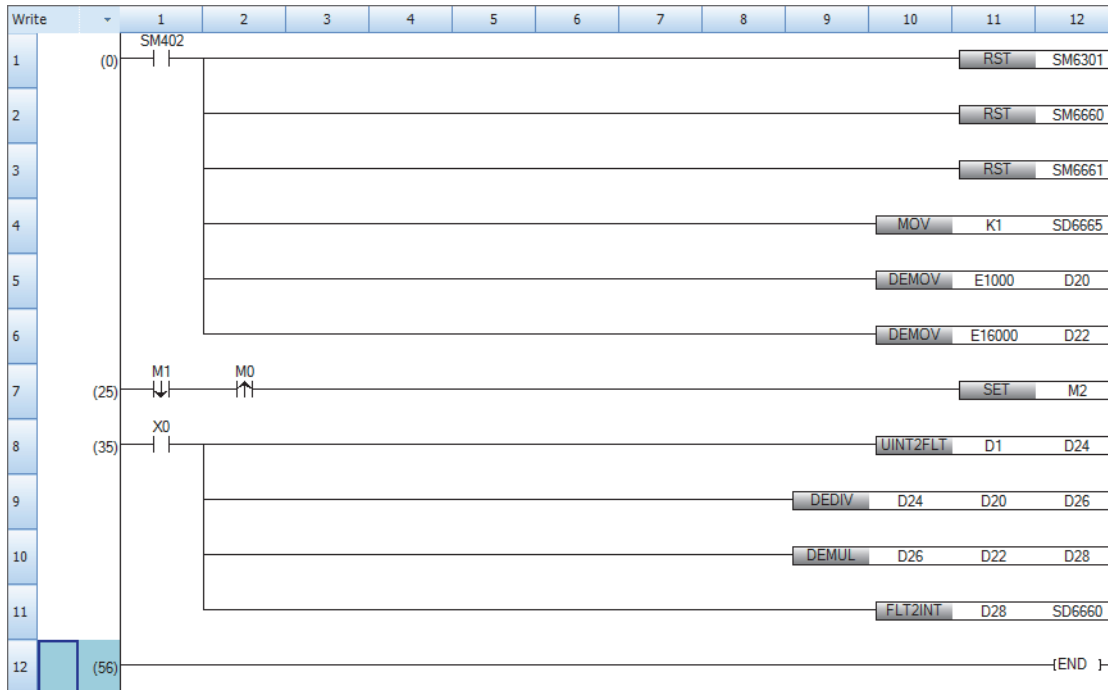

### Setting example 5

When "Control mode" is "Heating-cooling PID control mode", after auto tuning starts and ends completely, perform PID control using the obtained control parameters.

#### System configuration

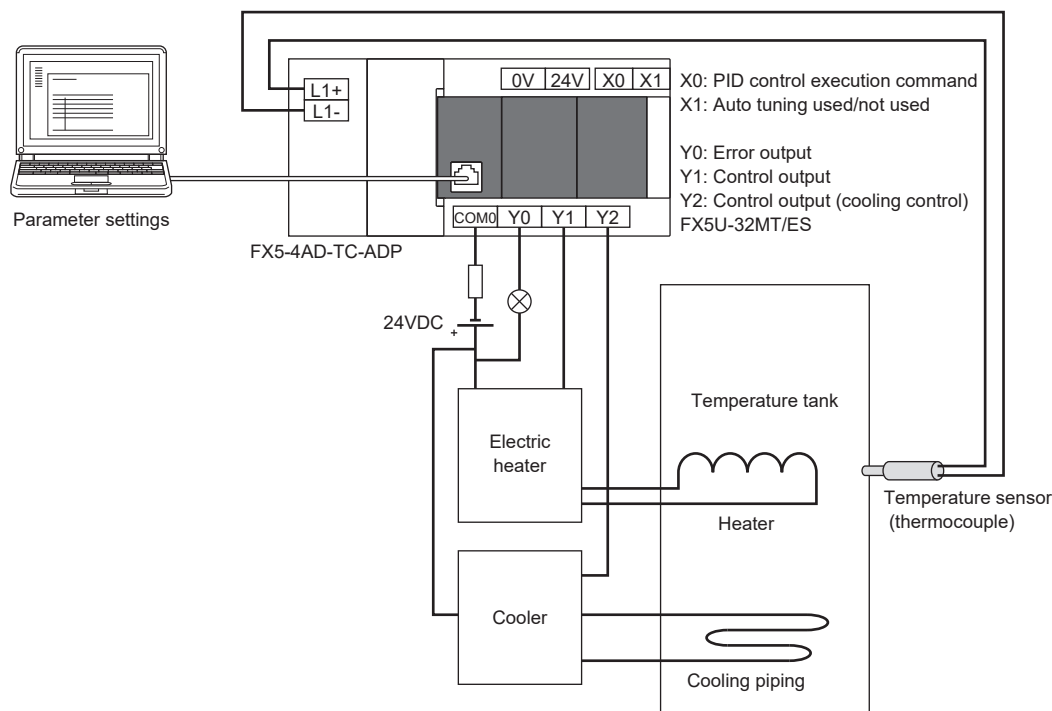

## ■ Operation example

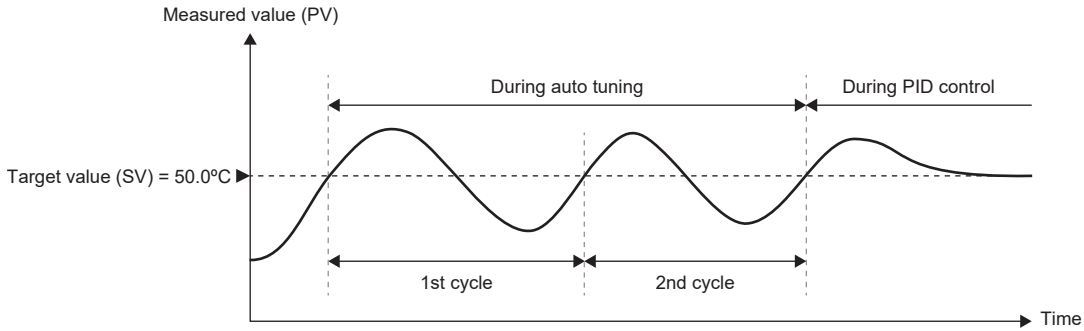

### ■ During auto tuning (when the heating upper limit output limiter is 90%)

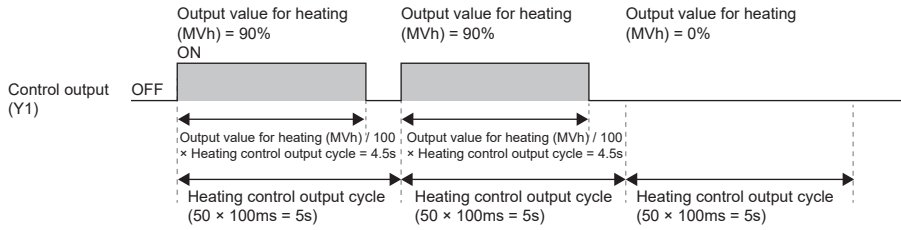

### ■ During auto tuning (when the cooling upper limit output limiter is 90%)

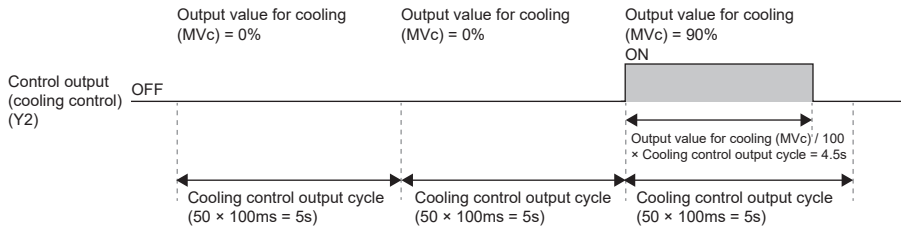

### ■ Heating control at PID control

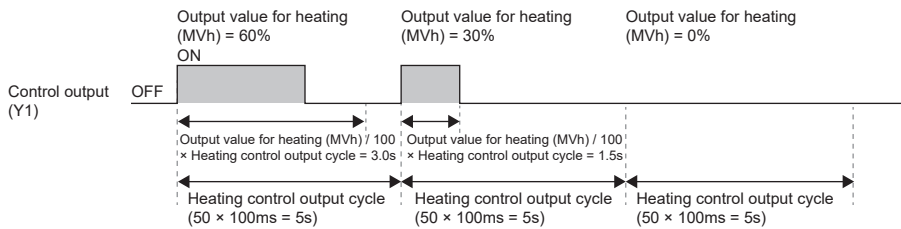

### ■ Cooling control at PID control

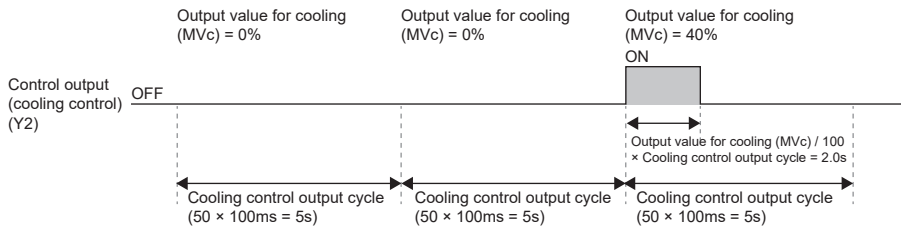

## Parameter setting example

Setting item		Setting value	Device indirect specification	
Basic Settings	To Use or Not to Use PID Control Function		Use	
	Control Mode Selection		Heating-cooling PID Control	
	Direct Action/Reverse Action Selection		—	
	Target Value (SV)		500	
	Process Value (PV)		—	
	Output Value (MV)		—	
	Heating Output Value (MVh)		—	
	Cooling Output Value (MVc)		—	
	Control Parameter	Proportional Gain (KP)	Not used	—
		Heating Proportional Gain (KPh)	Not used	D201
		Cooling Proportional Gain (KPc)	Not used	D202
		Integral Time (TI)	Not used	D203
		Derivative Time (TD)	Not used	D204
	Sampling Time (Ts)		10[×10ms]	Not used
	Operation Cycle	Control Output Cycle	—	—
		Heating Control Output Cycle	50[×100ms]	Not used
		Cooling Control Output Cycle	50[×100ms]	Not used
	Control Output		—	Y1
	Control Output (for Cooling Control)		—	Y2
	PID Control Execution Command		—	X0
To Use or Not to Use Auto-tuning		—	X1	
PID Control Execution Status		—	M0	
Auto-tuning Execution Status		—	M1	
PID Control Function Error Display		—	Y0	
PID Control Function Error Code		—	D10	
Application Settings	2-position Control Function	Adjustment sensitivity (dead band)	10	
	Overlap/Dead Band Setting		0	
	Output Limiter Function	Upper Limit Output Limiter	—	—
		Lower Limit Output Limiter	—	—
		Heating Upper Limit Output Limiter	900[×0.1%]	Not used
		Cooling Upper Limit Output Limiter	900[×0.1%]	Not used
	Output Variation Rate Limiter Function	Output Variation Rate Limiter	—	—
	Temperature Rise Completion Judgement Function	Temperature Rise Judgment Flag	—	M3
		Temperature Rise Completion Range	50	Not used
		Temperature Rise Completion Soak Time	5[s]	Not used
	Ambient Temperature Setting		Not used	Not used



## Operation example

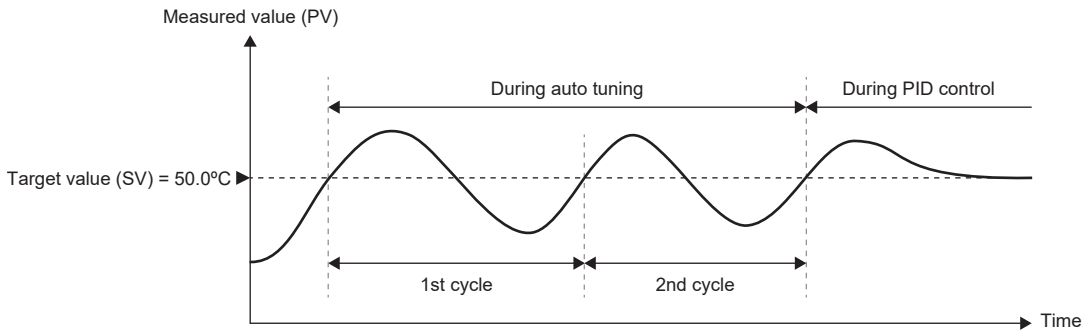

### During auto tuning (when the heating upper limit output limiter is 90%)

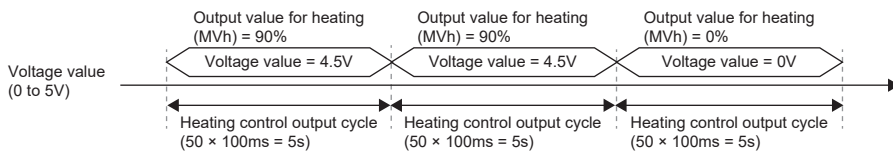

### During auto tuning (when the cooling upper limit output limiter is 90%)

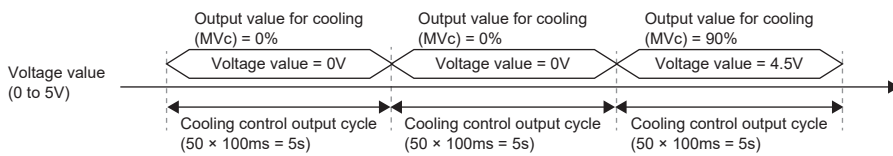

### Heating control at PID control

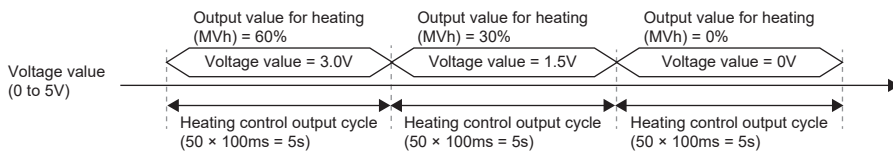

### Cooling control at PID control

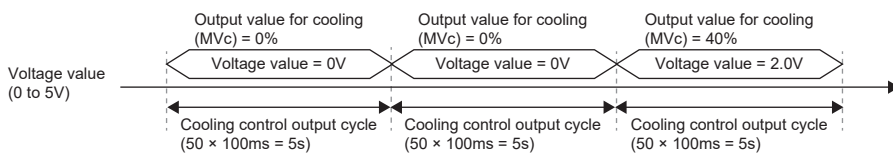

## Parameter setting example

Setting item		Setting value	Device indirect specification	
Basic Settings	To Use or Not to Use PID Control Function		Use	
	Control Mode Selection		Heating-cooling PID Control	
	Direct Action/Reverse Action Selection		—	
	Target Value (SV)		500	
	Process Value (PV)		—	
	Output Value (MV)		—	
	Heating Output Value (MVh)		—	
	Cooling Output Value (MVc)		—	
	Control Parameter	Proportional Gain (KP)	Not used	—
		Heating Proportional Gain (KPh)	Not used	D201
		Cooling Proportional Gain (KPc)	Not used	D202
		Integral Time (TI)	Not used	D203
		Derivative Time (TD)	Not used	D204
	Sampling Time (Ts)		10[×10ms]	Not used
	Operation Cycle	Control Output Cycle	—	—
		Heating Control Output Cycle	50[×100ms]	Not used
		Cooling Control Output Cycle	50[×100ms]	Not used
	Control Output		—	Not used
	Control Output (for Cooling Control)		—	Not used
	PID Control Execution Command		—	X0
	To Use or Not to Use Auto-tuning		—	X1
	PID Control Execution Status		—	M0
	Auto-tuning Execution Status		—	M1
PID Control Function Error Display		—	Y0	
PID Control Function Error Code		—	D10	
Application Settings	2-position Control Function	Adjustment sensitivity (dead band)	10	
	Overlap/Dead Band Setting		0	
	Output Limiter Function	Upper Limit Output Limiter	—	—
		Lower Limit Output Limiter	—	—
		Heating Upper Limit Output Limiter	900[×0.1%]	D412
		Cooling Upper Limit Output Limiter	900[×0.1%]	D413
	Output Variation Rate Limiter Function	Output Variation Rate Limiter	—	—
	Temperature Rise Completion Judgement Function	Temperature Rise Judgment Flag	—	M3
		Temperature Rise Completion Range	50	D415
		Temperature Rise Completion Soak Time	5[s]	D416
	Ambient Temperature Setting		Not used	Not used



## ■ Program example

### • Device setting example

Item	Device indirect specification	Description
A/D conversion enable/disable setting (CH1)	SM6301	FX5-4AD-TC-ADP(CH1) A/D conversion enable/disable setting (0: Enabled, 1: Disabled)
D/A conversion enable/disable setting	SM6660	FX5-4DA-ADP(CH1) D/A conversion enable/disable setting (0: Enabled, 1: Disabled)
	SM6700	FX5-4DA-ADP(CH2) D/A conversion enable/disable setting (0: Enabled, 1: Disabled)
D/A output enable/disable setting	SM6661	FX5-4DA-ADP(CH1) D/A output enable/disable setting (0: Enabled, 1: Disabled)
	SM6701	FX5-4DA-ADP(CH2) D/A output enable/disable setting (0: Enabled, 1: Disabled)
Output range setting	SD6665	FX5-4DA-ADP(CH1) output range setting (setting value 1: 0 to 5V)
	SD6705	FX5-4DA-ADP(CH2) output range setting (setting value 1: 0 to 5V)
Real number for division of output value for heating/cooling (MVh, MVc)	D20	Since the unit of the output value (MV) is $\times 0.1\%$ , store K1000 using a real number value.
	D21	
Real number for conversion of output value for heating/cooling (MVh, MVc) to digital value	D22	Since the voltage value (0 to 5V) is output in this program, store the maximum digital value K16000 using a real number value.
	D23	
Auto tuning completion flag	M2	Flag that turns on when auto tuning starts and ends completely
Digital value (CH1)	SD6660	FX5-4DA-ADP(CH1) digital value
Analog output value monitor (CH1)	SD6662	FX5-4DA-ADP(CH1) analog output value monitor
Output value for heating (MVh) (real number)	D24	Store the output value for heating (MVh) (after conversion to real number).
	D25	
Output value for heating (MVh) (0.00 to 1.00)	D26	Store the value obtained after conversion of the output value for heating (MVh) from a value in the range 0 to 1000 to a value the range 0.00 to 1.00.
	D27	
Digital value for heating (real number)	D28	Store the digital value for heating obtained by calculation using a real number value.
	D29	
Digital value (CH2)	SD6700	FX5-4DA-ADP(CH2) digital value
Analog output value monitor (CH2)	SD6702	FX5-4DA-ADP(CH2) analog output value monitor
Output value for cooling (MVc) (real number)	D30	Store the output value for cooling (MVc) (after conversion to real number).
	D31	
Output value for cooling (MVc) (0.00 to 1.00)	D32	Store the value obtained after conversion of the output value for cooling (MVc) from a value in the range 0 to 1000 to a value in the range 0.00 to 1.00.
	D33	
Digital value for cooling (real number)	D34	Store the digital value for cooling obtained by calculation using a real number value.
	D35	

• Program example

Set use permission for the FX5-4AD-TC-ADP(CH1), which was set as the process value (SD6300) when the state was changed from STOP to RUN, and configure settings for the FX5-4DA-ADP(CH1, 2). After PID control starts, perform conversion to the digital values (0 to 16000) to be output to the control target by using the output values for heating and cooling (MVh, MVc), and obtain the analog output values (SD6662, SD6702). Turn on the auto tuning completion flag when auto tuning is completed.

After writing the parameter settings and program to the CPU module, turn X1 (Auto tuning used/not used) on and turn X0 (PID control execution command) on, and auto tuning + PID control can be executed.

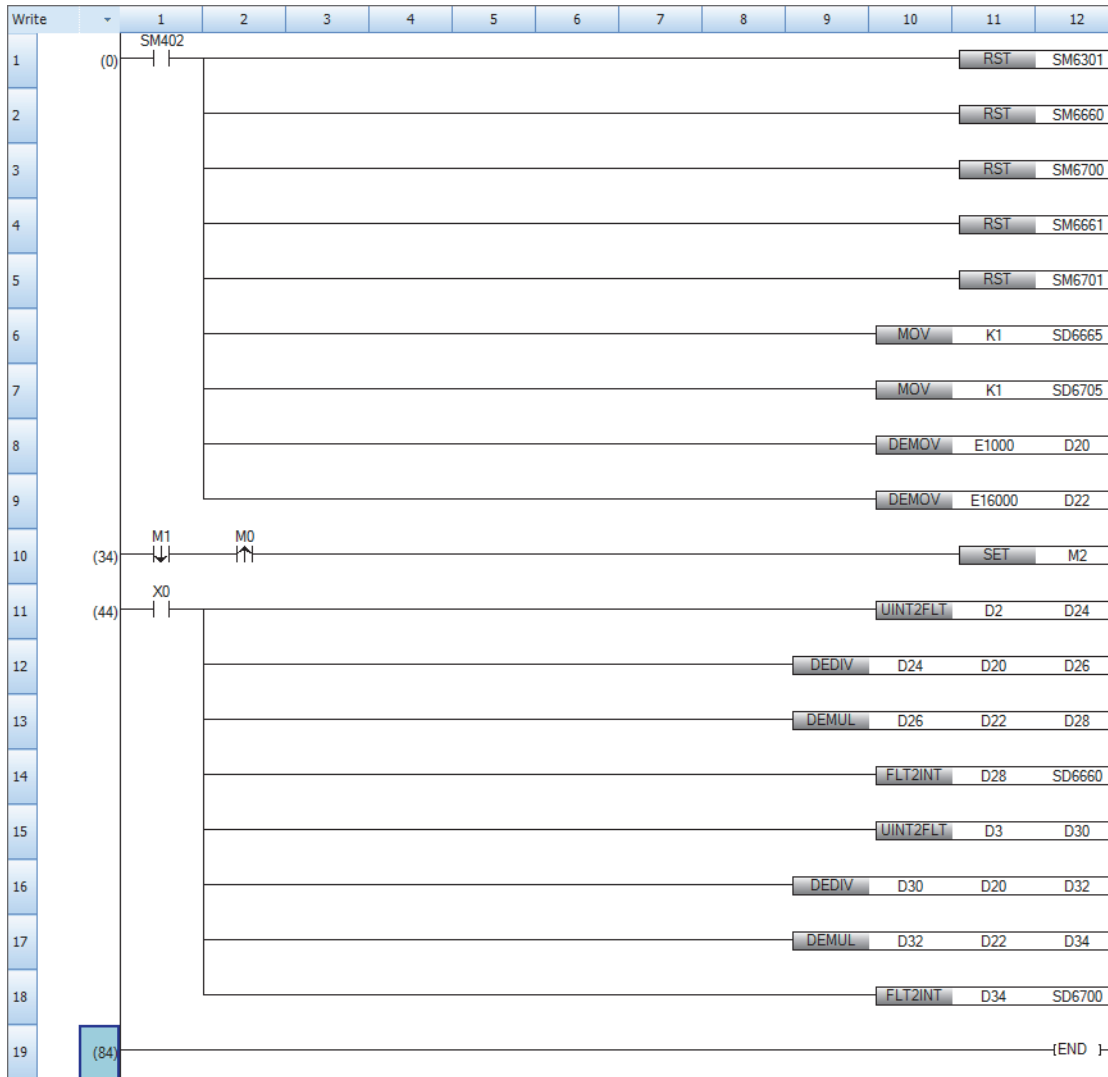

# Troubleshooting

## Troubleshooting with devices

Data on an error detected by the heating-cooling PID control function are stored into the devices set to the parameters "PID control function error indication" and "PID control function error code".

"1: Error occurrence" is written to the device set in "PID Control Function Error Display" when an error occurs, and the corresponding error code is written to the device set in "PID Control Function Error Code".

When an error occurs, either control is stopped, or control continues by rounding values. The execution status of the PID control function can be checked with the device set in the "PID Control Execution Status" parameter.

By monitoring the devices set above using the engineering tool and others, the execution status of PID control, error status, and error details can be checked. (An error cannot be checked if no device is set to the parameters.)

36

## When a hardware failure occurs

If a hardware failure occurs in a module connected to the programmable controller, check the hardware manual for the connected module.

## Error code overview

The error codes of errors that occur in this function are as follows.

Error code	Description	Reference
PID control continuation error (8100H to 8124H)	A PID control continuation error is a minor error, and even if it occurs, PID control can continue; therefore, depending on the content of the error, control is continued by changing the device values for parameters and others.	Page 886 Error codes of errors in PID control via parameter (8100H to 8230H)
PID control stop error (8200H to 8230H)	A PID control stop error is a major error, and if it occurs, PID control cannot continue easily; therefore, PID control is stopped immediately when it occurs. If a PID control stop error occurs, the device values for the following parameters are cleared. <ul style="list-style-type: none"><li>• Set off to the control output.</li><li>• Clear the output value (MV), output value for heating (MVh), and output value for cooling (MVc) to 0.</li><li>• Set off to the temperature rise judgment flag.</li><li>• Set off to the PID control execution status.</li><li>• Set off to the auto tuning execution status.</li></ul>	

## Precautions

### PID control affected by the constant scan setting

Since PID control is executed in END processing, depending on the constant scan setting (0.2 to 2000ms), a delay may occur in the sampling time or the control output cycle (heating control output cycle, cooling control output cycle), preventing stable PID control. If PID control is not stable, check the constant scan time setting.

### Multiple settings for PID control

For PID control, four settings can be configured at the same time. When devices are set in all parameters for which device indirect specification is possible, the number of devices to be used becomes 28 at maximum per one setting, and 112 at maximum for four settings. Ensure that no device duplication occurs in parameter settings.

### When setting parameters

Parameters cannot be written in any of the following cases. Be careful when setting parameters.

- If a device already set elsewhere is set
- If an item required to be set is not set

### Simultaneous use with another function

The scan time may become longer depending on another function. If the setting for the sampling time or control output cycle is not large enough in relation to the scan time, stable PID control may not be possible. Either check and correct the setting for the sampling time or control output cycle, or correct another function to be executed together.

### When the operating status of the CPU module is set to PAUSE.

While the PID control execution command is set to on, if the operating status of the CPU module is set to PAUSE, a PID control stop error occurs, and this function stops. If the CPU module is set to PAUSE, set the CPU module to STOP once, and then set it to RUN.

For details on the devices to be cleared when a PID control stop error occurs, refer to the following.

 Page 641 Error code overview

### When the setting value of a parameter is changed during control execution

Even if the setting value of a parameter is changed during control execution, the change is not applied to the control immediately. The change will be applied to the control in the sampling time cycle. Also, if the setting value of the sampling time is changed, the change will be applied at the timing of the sampling cycle before the change.

### ■When a setting value is changed during auto tuning execution

If a setting value of the parameter corresponding to the auto tuning stop conditions<sup>\*1</sup> is changed during auto tuning execution, a PID control stop error will occur, causing auto tuning to stop (the other setting values will not be changed even if a change is attempted).

\*1 For the auto tuning stop conditions, refer to the following.

 Page 620 Execution and stop conditions for auto tuning

### ■When the setting value of a parameter is changed during PID control execution

If the setting value of a parameter is changed as shown below during PID control execution, a PID control continuation error will occur. As a result, the parameter will be rounded to a value within the range, and PID control will continue.

- When the setting value of a parameter is changed to a value outside the range
- When the settings are changed to make "Sampling time  $\geq$  Control output cycle (heating control output cycle/cooling control output cycle)"
- When the settings are changed to make "(Sampling time  $\times$  10)  $>$  Derivative time"
- When the settings are changed to make "Upper limit output limiter  $\leq$  Lower limit output limiter"

If the setting value of a parameter is changed as shown below during PID control execution, a PID control continuation error will occur, and PID control will continue.

- When the magnitude relationship between the target value and the ambient temperature setting is changed
- When the settings are changed so that the "target value  $\pm$  adjustment sensitivity (dead band)" is the lower limit measurement value or less or the upper limit measurement value or more.
- When the settings are changed to make "Control output cycle (heating control output cycle/cooling control output cycle)  $<$  Scan time"

If the setting value of a parameter is changed as shown below during PID control execution, PID control will continue without generating an error. However, the operation is not performed based on the set value.

- When the settings are changed to make "Sampling time  $<$  Scan time"

## 36.7 Procedure to Execute the Built-in Analog Function

The procedure to execute the built-in analog function is described below.

### 1. Confirm the specifications of the built-in analog function.

Confirm the specifications of the built-in analog function. (  Page 542 Specifications)

### 2. Connect the CPU module to the external device.

Wiring to external devices. (  Page 643 Wiring)

### 3. Set the parameters.

Set the parameters to configure the built-in analog function. (  Page 644 Parameter Setting)

### 4. Create the program.

Create the program to use the built-in analog function.

### 5. Run the program.

#### Precautions

Do not write to the special relay/special register in the user interrupt program.

## 36.8 Wiring

For details on the wiring, refer to the following manual.

 MELSEC iQ-F FX5S/FX5UJ/FX5U/FX5UC User's Manual (Hardware)



# 36.9 Parameter Setting

Set the parameters of each channel.

Setting parameters here eliminates the need to program them.

**Point** 

Parameters are enabled when the CPU module is powered ON or after a reset. In addition, operations different from the parameter settings are possible by transferring values to special relays and special registers while changing these values in the program.

Refer to  Page 772 Special Relay List or  Page 799 Special Register List for details on the special relays and special registers.

## Basic settings (analog input)

### Setting procedure

Open "Basic Settings" of the GX Works3.

1. Start Module parameter.

 Navigation window ⇒ [Parameter] ⇒ Module model name ⇒ [Module Parameter] ⇒ [Analog Input] ⇒ [Basic Settings]

#### Window

Item	CH1	CH2
<b>A/D Conversion Enable/Disable Setting Function</b>	<b>Set AD conversion control method.</b>	
A/D Conversion Enable/Disable Setting	Disable	Disable
<b>A/D Conversion Method</b>	<b>Set AD conversion control method.</b>	
Average Processing Specify	Sampling	Sampling
Time Average Counts Average Moving Average	0 Times	0 Times

#### Displayed items

Item	Description	Setting range	Default
A/D Conversion Enable/Disable Setting	Set whether to "enable" or "disable" A/D conversion value output.	<ul style="list-style-type: none"> <li>• Enable</li> <li>• Disable</li> </ul>	Disable
Average Processing Specify	Execute whether to set "average process" or "sampling processing".	<ul style="list-style-type: none"> <li>• Sampling</li> <li>• Time Average</li> <li>• Count Average</li> <li>• Moving average</li> </ul>	Sampling
Time Average Counts Average Moving average	Set time average, count average, moving average counts during specifying average process for each channel.	User-defined value for the allowable setting range	0

2. Click the item to be changed to enter the setting value.

- Item where a value is selected from the pull-down list

Click [▼] button of the item to be set, and from the pull-down list that appears, select the value.

- Item where a value is entered into the text box

Double-click the item to be set to enter the numeric value.

# Application settings (analog input)

## Setting procedure

Open "Application Settings" of the GX Works3.

1. Start Module parameter.

Navigation window ⇒ [Parameter] ⇒ Module model name ⇒ [Module Parameter] ⇒ [Analog Input] ⇒ [Application Settings]

### Window

Item	CH1	CH2
<b>Warning Output Function</b>	<b>Execute the setting related to warning at A/D conversion.</b>	
Process Alarm Warning Setting	Disable	Disable
Process Alarm Upper Upper Limit Value	0	0
Process Alarm Upper Lower Limit Value	0	0
Process Alarm Lower Upper Limit Value	0	0
Process Alarm Lower Lower Limit Value	0	0
<b>Over Scale Detection</b>	<b>Execute the setting related to analog input value detection which exceeds the setting range.</b>	
Over Scale Detection Enable/Disable	Enable	Enable
<b>Scaling Setting</b>	<b>Execute the setting related to scaling at A/D conversion.</b>	
Scaling Enable/Disable	Disable	Disable
Scaling Upper Limit Value	0	0
Scaling Lower Limit Value	0	0
<b>Shift Function</b>	<b>Execute the setting related to shift function at A/D conversion.</b>	
Shifting Amount	0	0
<b>Digital Clip Setting</b>	<b>Execute the setting related to digital clip function at A/D conversion.</b>	
Digital Clip Enable/Disable	Disable	Disable

### Displayed items

Item	Description	Setting range	Default
Process Alarm Warning Setting	Set whether to "enable" or "disable" process alarm warning.	• Enable • Disable	Disable
Process Alarm Upper Upper Limit Value	Set the upper upper limit value of the digital output value.	-32768 to +32767	0
Process Alarm Upper Lower Limit Value	Set the upper lower limit value of the digital output value.	-32768 to +32767	0
Process Alarm Lower Upper Limit Value	Set the lower upper limit value of the digital output value.	-32768 to +32767	0
Process Alarm Lower Lower Limit Value	Set the lower lower limit value of the digital output value.	-32768 to +32767	0
Over Scale Detection Enable/Disable	Set whether to "enable" or "disable" over scale detection.	• Enable • Disable	Enable
Scaling Enable/Disable	Set whether to "enable" or "disable" scaling.	• Enable • Disable	Disable
Scaling Upper Limit Value	Set scaling conversion upper limit value.	-32768 to +32767	0
Scaling lower limit value	Set scaling conversion lower limit value.	-32768 to +32767	0
Shifting Amount	Set shifting amount for shifting function.	-32768 to +32767	0
Digital Clip Enable/Disable	Set whether to "enable" or "disable" digital clip.	• Enable • Disable	Disable

2. Click the item to be changed to enter the setting value.

- Item where a value is selected from the pull-down list

Click [▼] button of the item to be set, and from the pull-down list that appears, select the value.

- Item where a value is entered into the text box

Double-click the item to be set to enter the numeric value.

# Basic settings (analog output)

## Setting procedure

Open "Basic Settings" of the GX Works3.

1. Start Module parameter.

Navigation window ⇒ [Parameter] ⇒ Module model name ⇒ [Module Parameter] ⇒ [Analog Output] ⇒ [Basic Settings]

### Window

Item	CH
<input type="checkbox"/> <b>D/A Conversion Enable/Disable Setting Function</b> D/A Conversion Enable/Disable Setting	Set D/A conversion control method. Disable
<input type="checkbox"/> <b>D/A Output Enable/Disable Setting</b> D/A Output Enable/Disable Setting	Set D/A output conversion control method. Disable

### Displayed items

Item	Description	Setting range	Default
D/A Conversion Enable/Disable Setting	Set whether to "enable" or "disable" D/A conversion.	<ul style="list-style-type: none"> <li>Enable</li> <li>Disable</li> </ul>	Disable
D/A Output Enable/Disable Setting	Set whether to "enable" or "disable" D/A output.	<ul style="list-style-type: none"> <li>Enable</li> <li>Disable</li> </ul>	Disable

2. Click the item to be changed to enter the setting value.

- Item where a value is selected from the pull-down list

Click [▼] button of the item to be set, and from the pull-down list that appears, select the value.

- Item where a value is entered into the text box

Double-click the item to be set to enter the numeric value.



# Application settings (analog input)

## Setting procedure

Open "Application Settings" of the GX Works3.

1. Start Module parameter.

Navigation window ⇒ [Parameter] ⇒ Module model name ⇒ [Module Parameter] ⇒ [Analog Output] ⇒ [Application Settings]

### Window

Item	
<b>Warning Output Function</b>	<b>Execute the setting related to warning at D/A conversion.</b>
Warning Output Setting	Disable
Warning Upper Limit Value	0
Warning Lower Limit Value	0
<b>Scaling Setting</b>	<b>Execute the setting related to scaling at D/A conversion.</b>
Scaling Enable/Disable	Disable
Scaling Upper Limit Value	0
Scaling Lower Limit Value	0
<b>Shift Function</b>	<b>Execute the setting related to shift function at D/A conversion.</b>
Shift Value to Conversion Value	0
<b>Analog Output HOLD/CLEAR Setting</b>	<b>It can be set whether to HOLD the last value, setting value or CLEAR</b>
HOLD/CLEAR Setting	CLEAR
HOLD Setting Value	0

### Displayed items

Item	Description	Setting range	Default
Warning Output Setting	Set whether to "enable" or "disable" warning output.	• Enable • Disable	Disable
Warning Upper Limit value	Set the upper limit value of the digital input value for warning output.	-32768 to +32767	0
Warning Lower Limit value	Set the lower limit value of the digital input value for warning output.	-32768 to +32767	0
Scaling Enable/Disable	Set whether to "enable" or "disable" scaling.	• Enable • Disable	Disable
Scaling Upper Limit Value	Set scaling conversion upper limit value.	-32768 to +32767	0
Scaling lower limit value	Set scaling conversion lower limit value.	-32768 to +32767	0
Shift Value to Conversion Value	Set shifting amount for shifting function.	-32768 to +32767	0
HOLD/CLEAR Setting	Set output status at CLEAR or HOLD.	• CLEAR • Previous Value (Hold) • Setting Value	CLEAR
HOLD Setting Value	Set a digital value to be output at HOLD when "Setting Value" is selected in "HOLD/CLEAR Setting".	-32768 to +32767	0

2. Click the item to be changed to enter the setting value.

- Item where a value is selected from the pull-down list

Click [▼] button of the item to be set, and from the pull-down list that appears, select the value.

- Item where a value is entered into the text box

Double-click the item to be set to enter the numeric value.

# 36.10 How to Use Analog Inputs Built in CPU Module for Current Inputs

The analog input of the built-in analog can be used as the current input (4 to 20 mA DC) for the FX5U CPU module.

## Method of use with the current input (4 to 20 mA DC)

The FX5U CPU module is designed to handle only voltage inputs. However, the FX5U CPU module can be used for current inputs by connecting a 250 Ω resistor (precise resistance: 0.5%) between the V□+ terminal and the V- terminal.

### Example of wiring

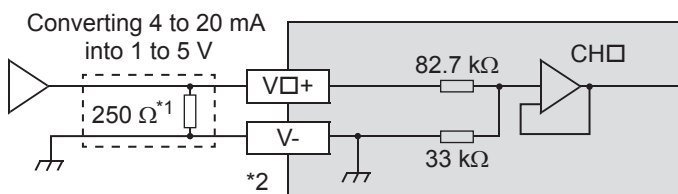

CH No. goes in □ of V□+, CH□.

- \*1 Instead of a 250 Ω resistor, a 500 Ω resistor can be connected in parallel. When selecting a resistor, consider the maximum input current.
- \*2 For unused channels, short-circuit the "V□+" and "V-" terminals.

### Specifications

Item	Specifications
Analog input	4 to 20 mA DC
Digital output value	400 to 2000 <sup>*1</sup>
Resolution	10 μA
Absolute maximum input	-2 mA, +60 mA

\*1 The digital output value can be changed using the scaling function.

### Example of using the scaling signal

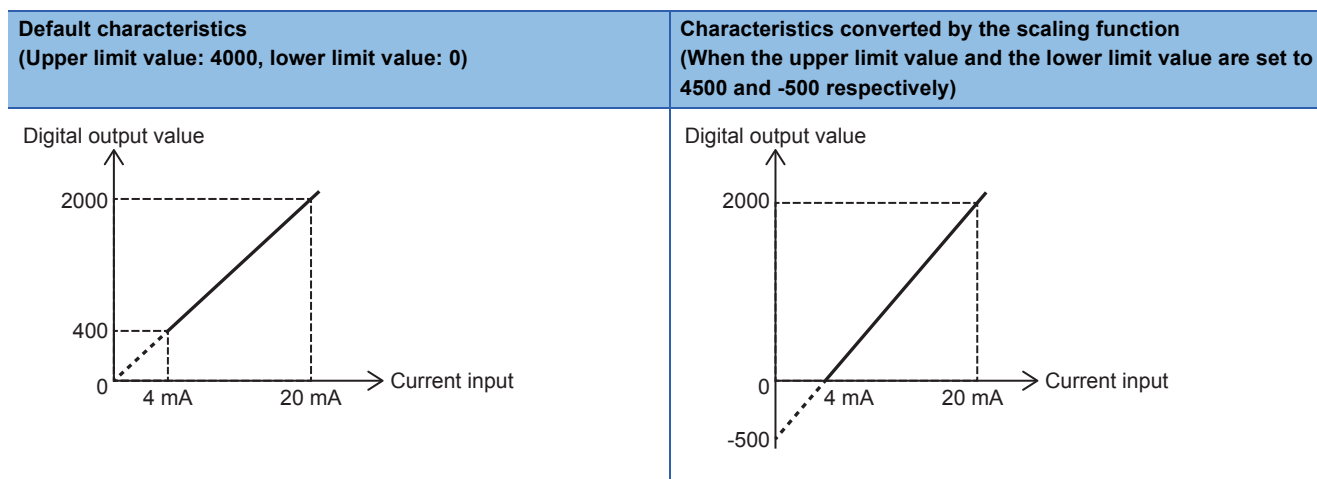

For details of the scaling function, refer to Page 552 Scaling function.

# 37 ANALOG ADAPTERS

This chapter describes analog adapters.

The following analog adapters are available.

Product	Model	Function	Description
Analog I/O expansion adapter	FX5-4A-ADP	Analog input Analog output	<p>This analog adapter connects to the CPU module, captures two points of voltage/current, and outputs the two points of voltage/current. A/D-converted values are written to special register areas assigned to each channel. D/A-converted analog data are output when values are set to special register areas assigned to each channel.</p> <ul style="list-style-type: none"> <li>• System configuration: <a href="#">Page 650 System Configuration</a></li> <li>• Power supply specifications: <a href="#">Page 650 Power supply specifications</a></li> <li>• Performance specifications: <a href="#">Page 651 Analog input, analog output</a></li> <li>• Procedures before operation: <a href="#">Page 659 Procedure to Operate the System</a></li> <li>• Functions: <a href="#">Page 660 Analog input</a> <a href="#">Page 662 Analog output</a> <a href="#">Page 665 Others</a></li> <li>• Parameter settings: <a href="#">Page 758 Parameter Setting</a></li> <li>• Troubleshooting: <a href="#">Page 767 Troubleshooting</a></li> </ul>
Analog input expansion adapter	FX5-4AD-ADP	Analog input	<p>This analog adapter connects to the CPU module and captures four points of voltage/current. A/D-converted values are written to special register areas assigned to each channel.</p> <ul style="list-style-type: none"> <li>• System configuration: <a href="#">Page 650 System Configuration</a></li> <li>• Power supply specifications: <a href="#">Page 650 Power supply specifications</a></li> <li>• Performance specifications: <a href="#">Page 651 Analog input specifications</a></li> <li>• Procedures before operation: <a href="#">Page 659 Procedure to Operate the System</a></li> <li>• Functions: <a href="#">Page 660 Analog input</a> <a href="#">Page 665 Others</a></li> <li>• Parameter settings: <a href="#">Page 758 Parameter Setting</a></li> <li>• Troubleshooting: <a href="#">Page 767 Troubleshooting</a></li> </ul>
Analog output expansion adapter	FX5-4DA-ADP	Analog output	<p>This analog adapter connects to the CPU module and outputs four points of voltage/current. D/A-converted analog data are output when values are set to special register areas assigned to each channel.</p> <ul style="list-style-type: none"> <li>• System configuration: <a href="#">Page 650 System Configuration</a></li> <li>• Power supply specifications: <a href="#">Page 650 Power supply specifications</a></li> <li>• Performance specifications: <a href="#">Page 651 Analog output specifications</a></li> <li>• Procedures before operation: <a href="#">Page 659 Procedure to Operate the System</a></li> <li>• Functions: <a href="#">Page 662 Analog output</a> <a href="#">Page 665 Others</a></li> <li>• Parameter settings: <a href="#">Page 758 Parameter Setting</a></li> <li>• Troubleshooting: <a href="#">Page 767 Troubleshooting</a></li> </ul>
RTD temperature sensor input expansion adapter	FX5-4AD-PT-ADP	Temperature sensor input	<p>This analog adapter connects to the CPU module and captures the temperature of four resistance temperature detectors. Temperature converted values are written to special register areas assigned to each channel.</p> <ul style="list-style-type: none"> <li>• System configuration: <a href="#">Page 650 System Configuration</a></li> <li>• Power supply specifications: <a href="#">Page 650 Power supply specifications</a></li> <li>• Performance specifications: <a href="#">Page 652 Specifications of temperature sensor input (for resistance temperature detector)</a></li> <li>• Procedures before operation: <a href="#">Page 659 Procedure to Operate the System</a></li> <li>• Functions: <a href="#">Page 664 Temperature sensor input</a> <a href="#">Page 665 Others</a></li> <li>• Parameter settings: <a href="#">Page 758 Parameter Setting</a></li> <li>• Troubleshooting: <a href="#">Page 767 Troubleshooting</a></li> </ul>
Thermocouple temperature sensor input expansion adapter	FX5-4AD-TC-ADP	Temperature sensor input	<p>This analog adapter connects to the CPU module and captures the temperature of four thermocouples. Temperature converted values are written to special register areas assigned to each channel.</p> <ul style="list-style-type: none"> <li>• System configuration: <a href="#">Page 650 System Configuration</a></li> <li>• Power supply specifications: <a href="#">Page 650 Power supply specifications</a></li> <li>• Performance specifications: <a href="#">Page 652 Specifications of temperature sensor input (for thermocouple)</a></li> <li>• Procedures before operation: <a href="#">Page 659 Procedure to Operate the System</a></li> <li>• Functions: <a href="#">Page 664 Temperature sensor input</a> <a href="#">Page 665 Others</a></li> <li>• Parameter settings: <a href="#">Page 758 Parameter Setting</a></li> <li>• Troubleshooting: <a href="#">Page 767 Troubleshooting</a></li> </ul>

# 37.1 System Configuration

This section describes the system configuration including analog adapters.

The maximum number of analog adapters that can be connected is shown below.

CPU module	Maximum number of connectable analog adapters
FX5S/FX5U/FX5UC CPU module	Four <sup>*1</sup>
FX5UJ CPU module	Two

\*1 For FX5-4A-ADP with serial number 223\*\*\*\* or earlier, the maximum number of connectable modules is 2.

The connection position of the analog adapter connected to each CPU module are counted as the first module, the second module, and so on in order of proximity to the CPU module.

However, communication adapters are not counted towards the number of analog adapters.

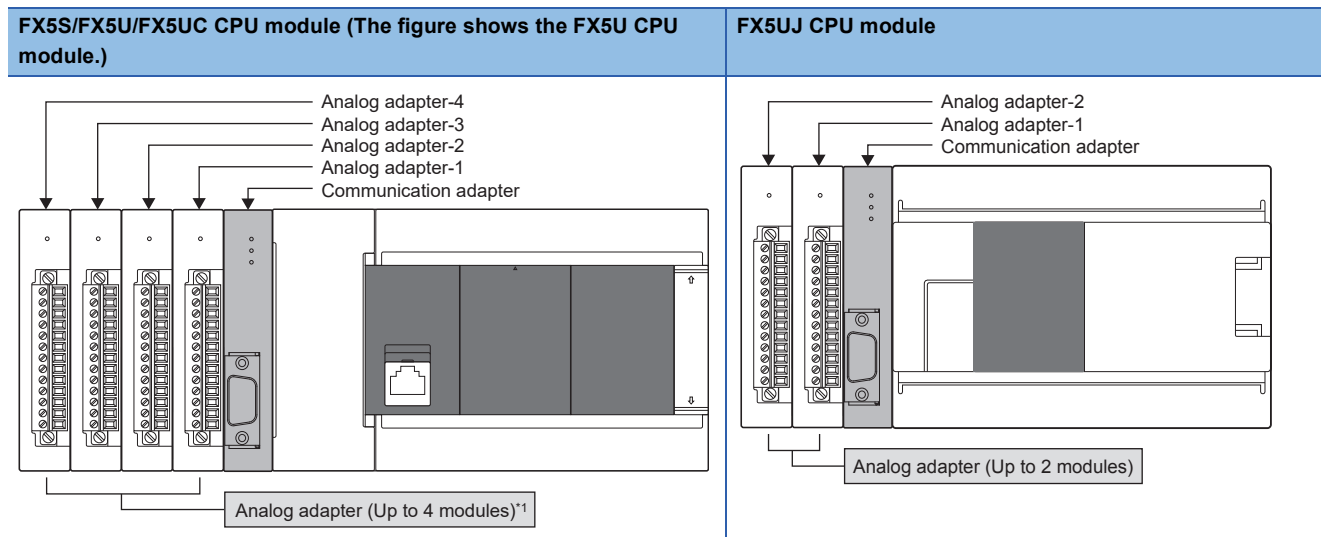

\*1 For FX5-4A-ADP with the serial number 223\*\*\*\* or earlier, the maximum number of connectable modules is 2.

# 37.2 Specifications

This section describes the specifications.

## Generic specifications

For general specifications, refer to the following manual.

📖 MELSEC iQ-F FX5S/FX5UJ/FX5U/FX5UC User's Manual (Hardware)

## Power supply specifications

Power supply specifications is shown below.

Item		Specification				
		FX5-4A-ADP	FX5-4AD-ADP	FX5-4DA-ADP	FX5-4AD-PT-ADP	FX5-4AD-TC-ADP
External power supply <sup>*1</sup>	Power supply voltage	24VDC +20%/-15%	—	24VDC +20%/-15%	—	—
	Current consumption	100mA	—	160mA	—	—
Internal power supply <sup>*2</sup>	Power supply voltage	5VDC	5VDC, 24VDC	5VDC	5VDC, 24VDC	
	Current consumption	10mA	5VDC: 10mA 24VDC: 20mA	10mA	5VDC: 10mA 24VDC: 20mA	

\*1 External electric supply is carried out from the power supply connector of an adapter.

\*2 Internal electric supply is carried out from the power capacity of the CPU module.

# Performance specifications

Performance specifications is shown below.

## Analog input, analog output

### ■Analog input specifications

Item		Specification	
		FX5-4A-ADP	FX5-4AD-ADP
Number of analog input points		2 points (CH1, CH2)	4 points (CH1, CH2, CH3, CH4)
Analog input voltage		-10 to +10VDC (input resistance value 1MΩ)	
Analog input current		-20 to +20mA DC (input resistance value 250Ω)	
Digital output value		14-bit binary value	
Input characteristics	Voltage	0 to 10V	0 to 16000
		0 to 5V	0 to 16000
		1 to 5V	0 to 12800
		-10 to +10V	-8000 to +8000
	Current	0 to 20mA	0 to 16000
		4 to 20mA	0 to 12800
-20 to +20mA		-8000 to +8000	
Resolution	Voltage	0 to 10V	625μV
		0 to 5V	312.5μV
		1 to 5V	312.5μV
		-10 to +10V	1250μV
	Current	0 to 20mA	1.25μA
		4 to 20mA	1.25μA
-20 to +20mA		2.5μA	
Accuracy (accuracy for the full scale of the digital output value)		Ambient temperature 25±5°C: Within ±0.1% (±16 digits) Ambient temperature 0 to 55°C: Within ±0.2% (±32 digits) Ambient temperature -20 to 0°C*1: Within ±0.3% (±48 digits)	
Absolute maximum input		Voltage: ±15V, Current: ±30mA	

\*1 This specification does not apply to the FX5-4AD-ADP manufactured before June 2016.

For the input conversion characteristic, refer to the  Page 653 Input conversion characteristics.

### ■Analog output specifications

Item		Specification	
		FX5-4A-ADP	FX5-4DA-ADP
Number of analog output points		2 points (CH3, CH4)	4 points (CH1, CH2, CH3, CH4)
Digital input		14-bit binary value	
Analog output voltage		-10 to +10V DC (external load resistance value 1k to 1MΩ)	
Analog output current		0 to 20mA DC (external load resistance value 0 to 500Ω)	
Output characteristics	Voltage	0 to 10V	0 to 16000
		0 to 5V	0 to 16000
		1 to 5V	0 to 16000
		-10 to +10V	-8000 to +8000
	Current	0 to 20mA	0 to 16000
		4 to 20mA	0 to 16000
Resolution	Voltage	0 to 10V	625μV
		0 to 5V	312.5μV
		1 to 5V	250μV
		-10 to +10V	1250μV
	Current	0 to 20mA	1.25μA
		4 to 20mA	1μA

Item	Specification	
	FX5-4A-ADP	FX5-4DA-ADP
Accuracy (accuracy for the full scale of the digital output value)	Ambient temperature 25±5°C: Within ±0.1% (voltage ±20mV, current ±20μA) Ambient temperature 0 to 55°C: Within ±0.2% (voltage ±40mV, current ±40μA) Ambient temperature -20 to 0°C: Within ±0.3% (voltage ±60mV, current ±60μA)	Ambient temperature 25±5°C: Within ±0.1% (voltage ±20mV, current ±20μA) Ambient temperature -20 to 55°C <sup>*1</sup> : Within ±0.2% (voltage ±40mV, current ±40μA)

\*1 The ambient temperature is 0 to 55°C for products manufactured before June 2016.

For the output conversion characteristic, refer to the  Page 655 Output conversion characteristics.

## Common specifications

Item	Specification		
	FX5-4A-ADP	FX5-4AD-ADP	FX5-4DA-ADP
Conversion speed <sup>*1</sup>	<ul style="list-style-type: none"> <li>When the FX5S CPU module is used Maximum 2.2ms</li> <li>When the FX5UJ/FX5U/FX5UC CPU module is used Maximum 2.0ms</li> </ul>	<ul style="list-style-type: none"> <li>When the FX5S CPU module is used Maximum 500μs</li> <li>When the FX5UJ/FX5U/FX5UC CPU module is used Maximum 450μs</li> </ul>	<ul style="list-style-type: none"> <li>When the FX5S CPU module is used Maximum 1100μs</li> <li>When the FX5UJ/FX5U/FX5UC CPU module is used Maximum 950μs</li> </ul>
Number of occupied I/O points	0 point (This number is not related to the maximum number of I/O points of the programmable controller.)		

\*1 Data is updated every operation cycle.

## Temperature sensor input

### Specifications of temperature sensor input (for resistance temperature detector)

Item	Specification		
		Celsius (°C)	Fahrenheit (°F)
Number of analog input points	4 points (CH1, CH2, CH3, CH4)		
Usable resistance temperature detector <sup>*1</sup>	Pt100 (JIS C 1604-1997, JIS C 1604-2013) Ni100 (DIN 43760 1987)		
Temperature measuring range	Pt100	-200 to +850°C	-328 to +1562°F
	Ni100	-60 to +250°C	-76 to +482°F
Digital output value	—	16-bit signed binary	
	Pt100	-2000 to +8500	-3280 to +15620
	Ni100	-600 to +2500	-760 to +4820
Accuracy	Ambient temperature 25±5°C	Pt100	±0.8°C
		Ni100	±0.4°C
	Ambient temperature -20 to 55°C	Pt100	±2.4°C
		Ni100	±1.2°C
Resolution	0.1°C	0.1 to 0.2°F	
Conversion speed	Approx. 85 ms/channel <sup>*2</sup>		
Number of occupied I/O points	0 point (This number is not related to the maximum number of I/O points of the programmable controller.)		

\*1 An usable resistance temperature detector is 3-wire type only.

\*2 For details of the conversion speed, refer to  Page 733 Temperature conversion method.

### Specifications of temperature sensor input (for thermocouple)

Item	Specification		
		Celsius (°C)	Fahrenheit (°F)
Number of analog input points	4 points (CH1, CH2, CH3, CH4)		
Usable thermocouple	K, J, T, B, R, S (JIS C 1602-1995)		
Temperature measuring range	K	-200 to +1200°C	-328 to +2192°F
	J	-40 to +750°C	-40 to +1382°F
	T	-200 to +350°C	-328 to +662°F
	B	600 to 1700°C	1112 to 3092°F
	R	0 to 1600°C	32 to 2912°F
	S	0 to 1600°C	32 to 2912°F

Item		Specification		
		Celsius (°C)	Fahrenheit (°F)	
Digital output value	—	16-bit signed binary		
	K	-2000 to +12000	-3280 to +21920	
	J	-400 to +7500	-400 to +13820	
	T	-2000 to +3500	-3280 to +6620	
	B	6000 to 17000	11120 to 30920	
	R	0 to 16000	320 to 29120	
	S	0 to 16000	320 to 29120	
Accuracy <sup>*1</sup>	Ambient temperature 25±5°C	K	$\pm 3.7^{\circ}\text{C}$ (-100 to +1200°C) <sup>*2</sup> , $\pm 4.9^{\circ}\text{C}$ (-150 to -100°C) <sup>*2</sup> , $\pm 7.2^{\circ}\text{C}$ (-200 to -150°C) <sup>*2</sup>	
		J	$\pm 2.8^{\circ}\text{C}$	
		T	$\pm 3.1^{\circ}\text{C}$ (0 to 350°C) <sup>*2</sup> , $\pm 4.1^{\circ}\text{C}$ (-100 to 0°C) <sup>*2</sup> , $\pm 5.0^{\circ}\text{C}$ (-150 to -100°C) <sup>*2</sup> , $\pm 6.7^{\circ}\text{C}$ (-200 to -150°C) <sup>*2</sup>	
		B	$\pm 3.5^{\circ}\text{C}$	
		R	$\pm 3.7^{\circ}\text{C}$	
		S	$\pm 3.7^{\circ}\text{C}$	
	Ambient temperature -20 to 55°C	K	$\pm 6.5^{\circ}\text{C}$ (-100 to +1200°C) <sup>*2</sup> , $\pm 7.5^{\circ}\text{C}$ (-150 to -100°C) <sup>*2</sup> , $\pm 8.5^{\circ}\text{C}$ (-200 to -150°C) <sup>*2</sup>	
		J	$\pm 4.5^{\circ}\text{C}$	
		T	$\pm 4.1^{\circ}\text{C}$ (0 to 350°C) <sup>*2</sup> , $\pm 5.1^{\circ}\text{C}$ (-100 to 0°C) <sup>*2</sup> , $\pm 6.0^{\circ}\text{C}$ (-150 to -100°C) <sup>*2</sup> , $\pm 7.7^{\circ}\text{C}$ (-200 to -150°C) <sup>*2</sup>	
		B	$\pm 6.5^{\circ}\text{C}$	
		R	$\pm 6.5^{\circ}\text{C}$	
		S	$\pm 6.5^{\circ}\text{C}$	
Resolution	K, J, T	0.1°C	0.1 to 0.2°F	
	B, R, S	0.1 to 0.3°C	0.1 to 0.6°F	
Conversion speed	Approx. 85 ms/channel <sup>*3</sup>			
Number of occupied I/O points	0 point (This number is not related to the maximum number of I/O points of the programmable controller.)			

\*1 A 45-minute warm-up (energization) is required to satisfy the accuracy condition.  
 \*2 The accuracy differs depending on the ranges of the measured temperature in ().  
 \*3 For details of the conversion speed, refer to  Page 733 Temperature conversion method.

## Input conversion characteristics

- FX5-4A-ADP, FX5-4AD-ADP

The input conversion characteristic of A/D conversion is the slope of a straight line connecting the offset value and gain value when converting analog input (voltage or current) from outside the programmable controller into a digital value.

### Voltage input characteristic

The following shows the list of the analog input ranges and the graphs of each voltage input characteristic, at the voltage input.

No.	Input range setting	Offset value	Gain value	Digital output value <sup>*1</sup>	Resolution
(1)	0 to 10V	0V	10 V	0 to 16000	625μV
(2)	0 to 5V	0V	5 V	0 to 16000	312.5μV
(3)	1 to 5V	1V	5 V	0 to 12800	312.5μV
(4)	-10 to +10V	0V	10 V	-8000 to +8000	1250μV

\*1 If the analog input exceeds the digital output value range, the digital output value is fixed at the maximum or minimum value.

Input range setting	Digital output value	
	Maximum	Maximum
0 to 10V	-384	16383
0 to 5V	-384	16383
1 to 5V	-3584	13183
-10 to +10V	-8192	8191

- Use a value within the analog input practical range and digital output practical range of each input range. If the values are out of the range, the resolution and accuracy may not fall within the range of the performance specifications. (Avoid using the dotted line part of the voltage input characteristic graph.)
- Do not set the voltage over  $\pm 15$  V. Doing so can cause breakdown of the products.

### Voltage input characteristic graph

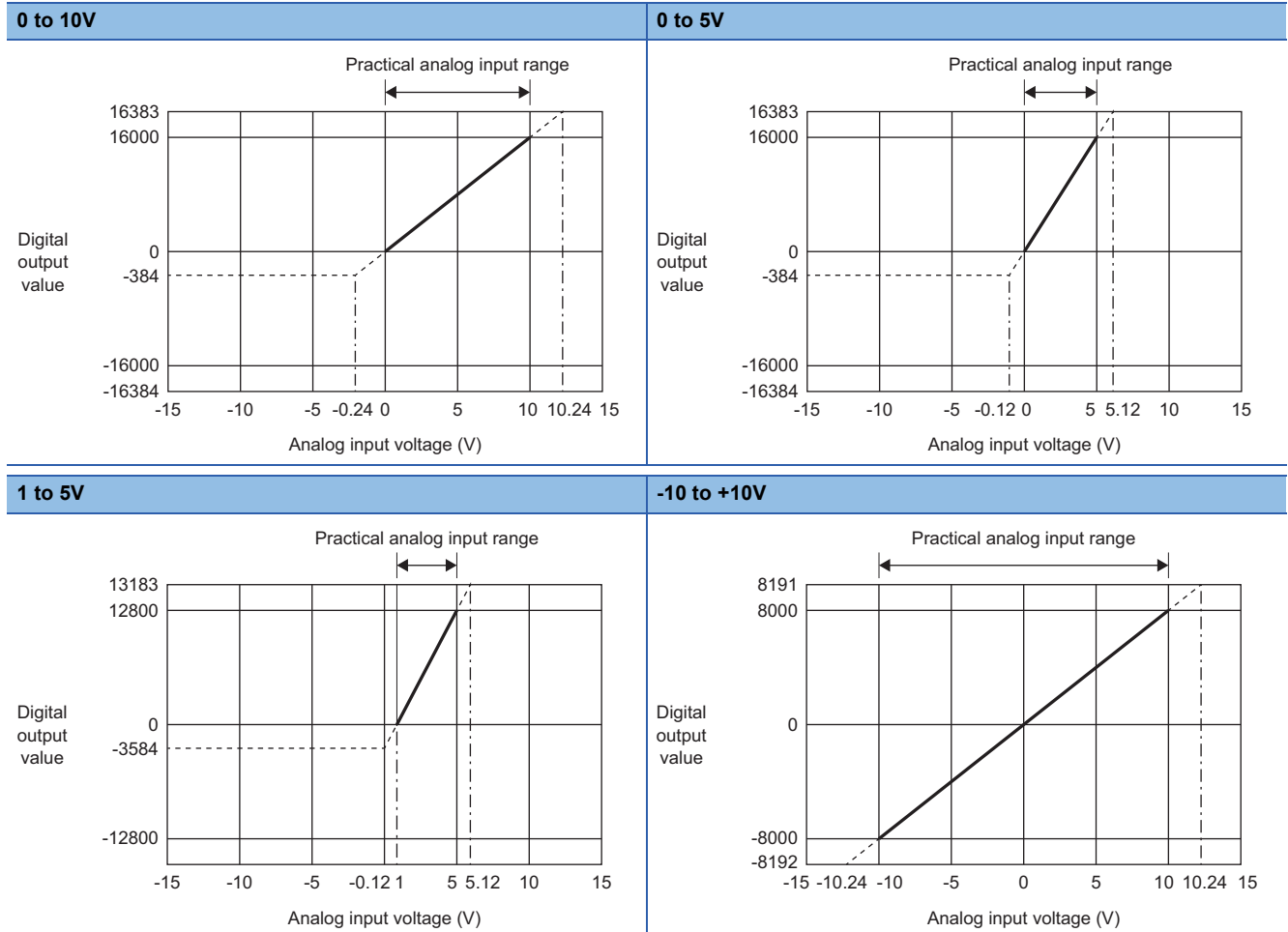

### Current input characteristic

The following shows the list of the analog input ranges and the graph of each current input characteristic, at the current input.

No.	Input range setting	Offset value	Gain value	Digital output value <sup>*1</sup>	Resolution
(1)	0 to 20mA	0mA	20 mA	0 to 16000	1.25 $\mu$ A
(2)	4 to 20mA	4mA	20 mA	0 to 12800	1.25 $\mu$ A
(3)	-20 to +20mA	0mA	20 mA	-8000 to +8000	2.5 $\mu$ A

\*1 If the analog input exceeds the digital output value range, the digital output value is fixed at the maximum or minimum value.

Input range setting	Digital output value	
	Maximum	Maximum
0 to 20mA	-384	16383
4 to 20mA	-3584	13183
-20 to +20mA	-8192	8191



- Use a value within the analog input practical range and digital output practical range of each input range. If the values are out of the range, the resolution and accuracy may not fall within the range of the performance specifications. (Avoid using the dotted line part of the current input characteristic graph.)
- Do not set the voltage over  $\pm 30$  mA. Doing so can cause breakdown of the products.

### Current input characteristic graph

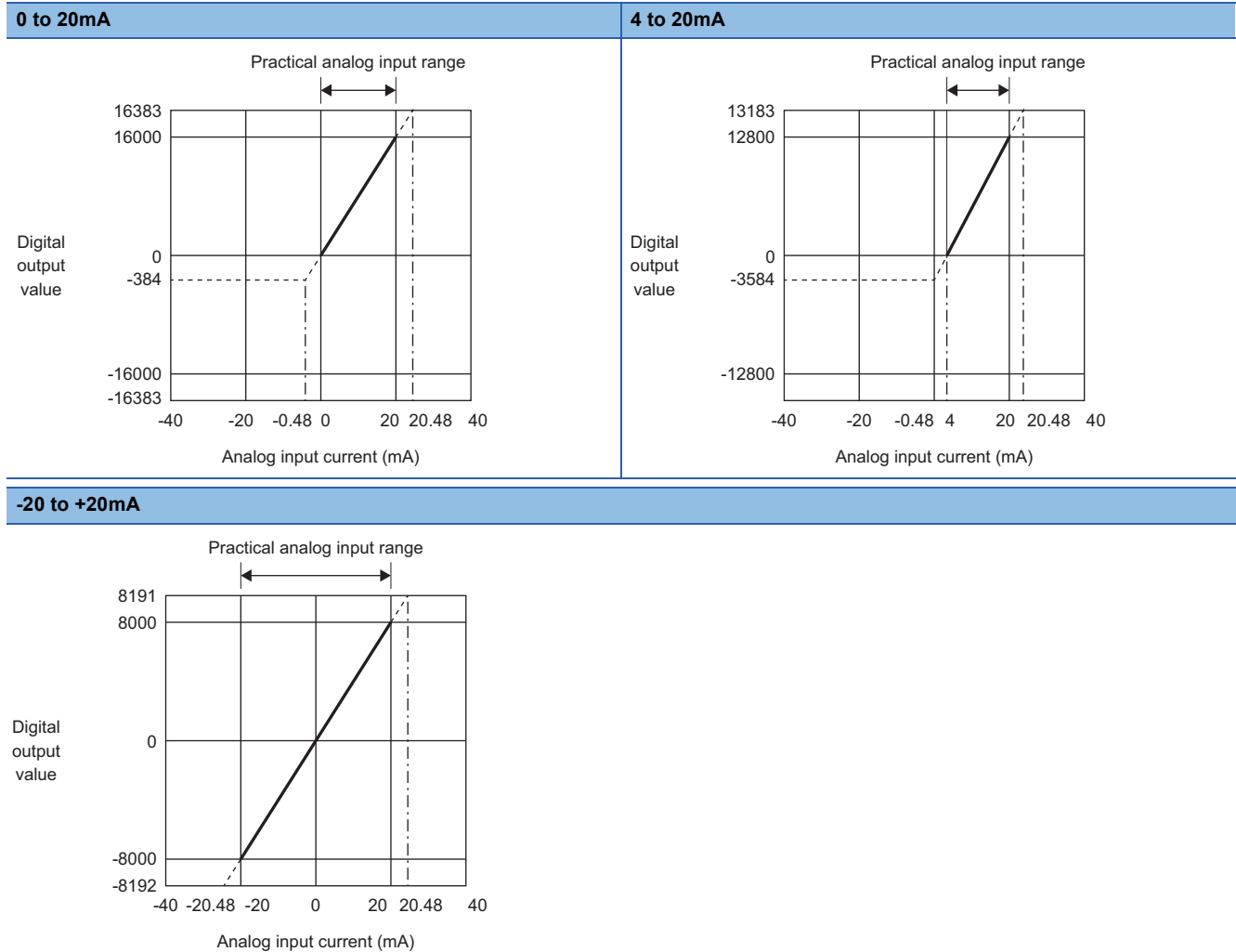

## Output conversion characteristics

- FX5-4A-ADP, FX5-4DA-ADP

The output conversion characteristic of D/A conversion is the slope of a straight line connecting the offset value and gain value when converting the digital value written from the CPU module to analog output (voltage or current).

### Voltage output characteristic

The following shows the list of the analog output ranges and the graphs of each voltage output characteristic, at the voltage output.

No.	Output range setting	Offset value	Gain value	Digital value*1	Resolution
(1)	0 to 10V	0V	10 V	0 to 16000	625 $\mu$ V
(2)	0 to 5V	0V	5 V	0 to 16000	312.5 $\mu$ V
(3)	1 to 5V	1V	5 V	0 to 16000	250 $\mu$ V
(4)	-10 to +10V	0V	10 V	-8000 to +8000	1250 $\mu$ V

\*1 If the input exceeds the digital value range, the digital value is fixed at the maximum or minimum value.

Output range setting	Digital value	
	Maximum	Minimum
0 to 10V	-384	16383
0 to 5V	-384	16383
1 to 5V	-384	16383
-10 to +10V	-8192	8191

**Point**

Use a value within the digital input practical range and analog output practical range of each output range. If the values are out of the range, the resolution and accuracy may not fall within the range of the performance specifications. (Avoid using the dotted line part of the voltage output characteristic graph.)

**■ Voltage output characteristic graph**

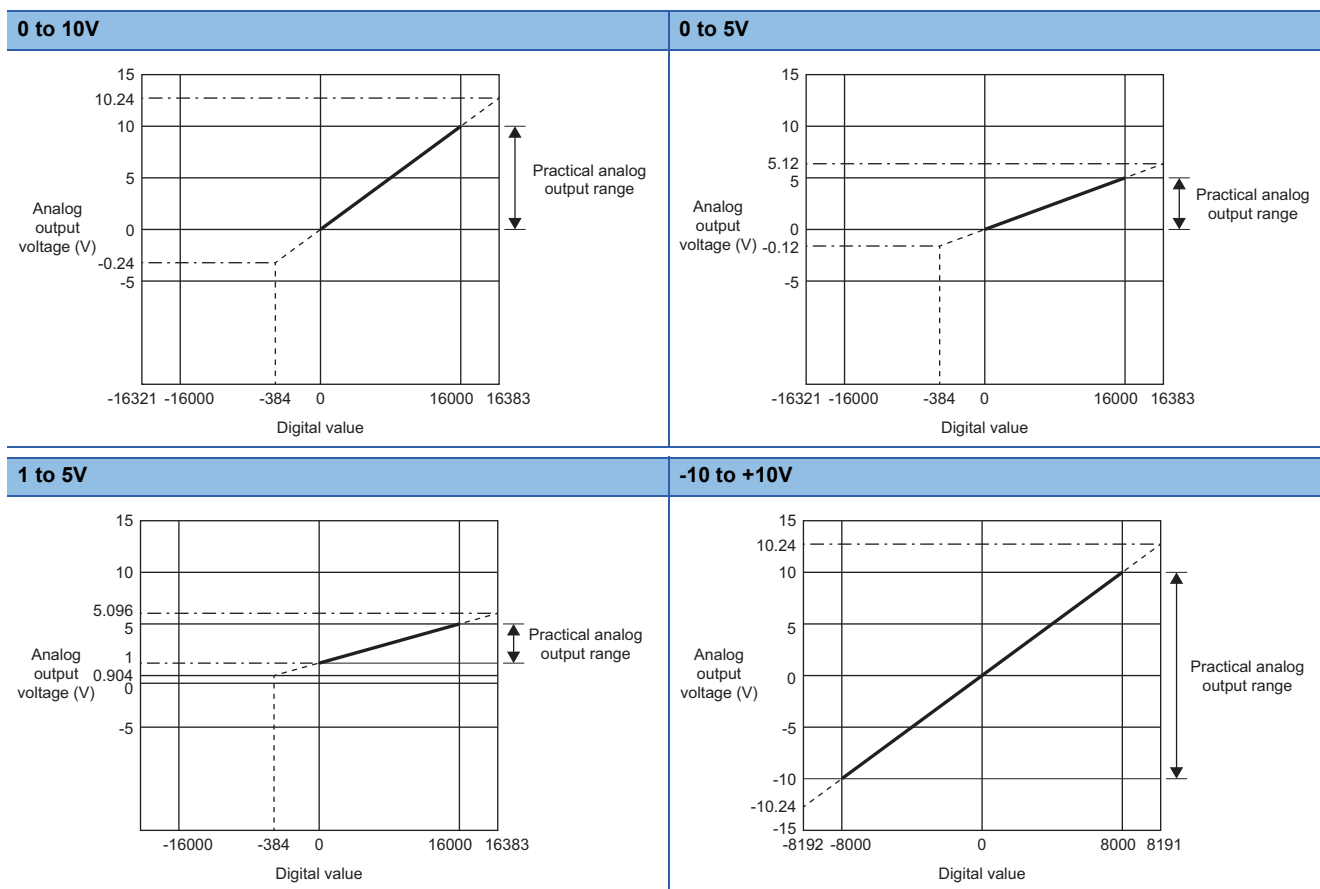

**Current output characteristic**

The following shows the list of the analog output ranges and the graphs of each current output characteristic, at the current output.

No.	Output range setting	Offset value	Gain value	Digital value*1	Resolution
(1)	0 to 20mA	0mA	20 mA	0 to 16000	1.25μA
(2)	4 to 20mA	4mA	20 mA	0 to 16000	1μA

\*1 If the input exceeds the digital value range, the digital value is fixed at the maximum or minimum value.

Output range setting	Digital value	
	Maximum	Minimum
0 to 20mA	-384	16383
4 to 20mA	-384	16383

Use a value within the digital input practical range and analog output practical range of each output range. If the values are out of the range, the resolution and accuracy may not fall within the range of the performance specifications. (Avoid using the dotted line part of the current output characteristic graph.)

### ■ Current output characteristic graph

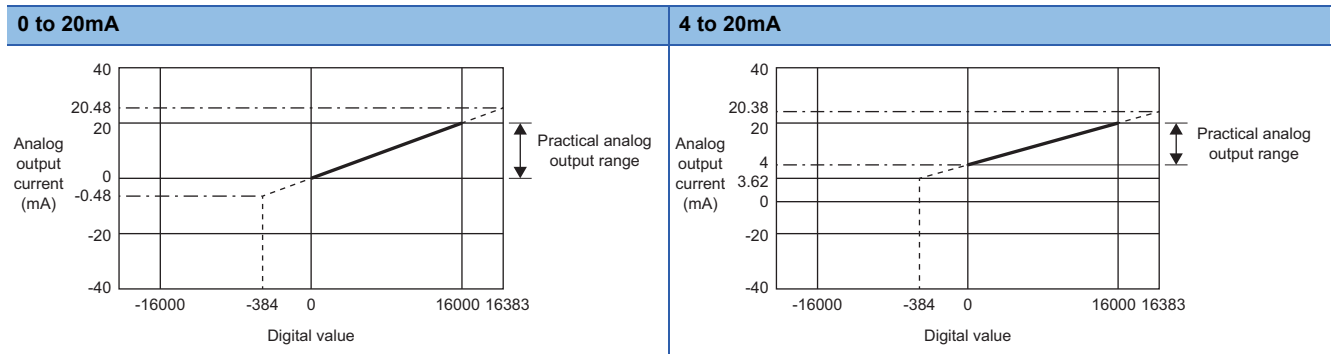

## Accuracy

### Analog input accuracy

Accuracy of A/D conversion is determined by the accuracy for the full scale of digital output value. An input characteristic change through changes of the offset/gain setting or the input range does not sacrifice the accuracy, which is maintained within the described range of the performance specifications.

The following graph shows the fluctuation range of accuracy when the range of -10V to +10V is selected.

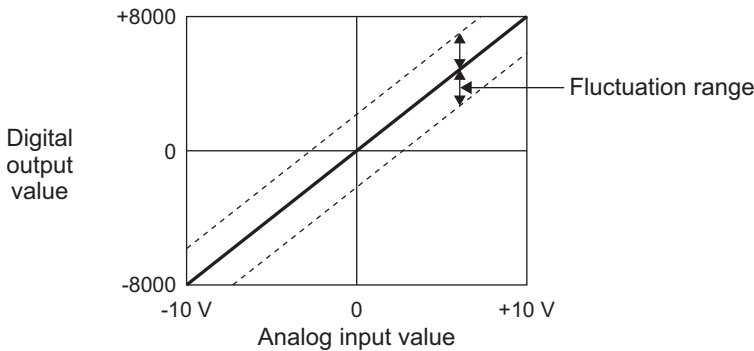

The accuracy will be as shown below depending on the operating ambient temperature. (Except for the conditions under the influence of noise)

Item	Specification
Ambient temperature 25±5°C	±0.1% (±16 digits)
Ambient temperature 0 to 55°C	±0.2% (±32 digits)
Ambient temperature -20 to 0°C	±0.3% (±48 digits)

## Analog output accuracy

Accuracy of D/A conversion is determined by the accuracy for the full scale of analog output value.

An output characteristic change through changes of the offset/gain setting or the output range does not sacrifice the accuracy, which is maintained within the described range of the performance specifications.

The following graph shows the fluctuation range of accuracy when the range of -10V to +10V is selected.

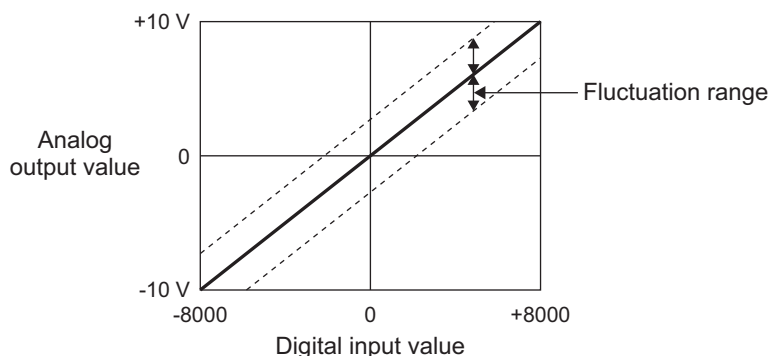

The accuracy will be as shown below depending on the operating ambient temperature. (Except for the conditions under the influence of noise)

Item	Specification	
	FX5-4A-ADP	FX5-4DA-ADP
Ambient temperature 25±5°C	±0.1% (±20mV)	±0.1% (±20mV)
Ambient temperature 0 to 55°C	±0.2% (±40mV)	±0.2% (±40mV)
Ambient temperature -20 to 0°C	±0.3% (±60mV)	

## Temperature sensor input accuracy

### • FX5-4AD-PT-ADP

Accuracy of resistance temperature detector (including cable) is not included.

The accuracy specifications may not be satisfied temporarily when affected by noise.

Item	Specification	
Ambient temperature 25±5°C	Pt100	±0.8%
	Ni100	±0.4%
Ambient temperature -20 to 55°C	Pt100	±2.4%
	Ni100	±1.2%

### • FX5-4AD-TC-ADP

Does not include the accuracy of the thermocouple and the compensating conductor.

The accuracy specifications may not be satisfied temporarily when affected by noise.

Item	Specification	
Ambient temperature 25±5°C	K	±3.7°C (-100 to +1200°C) <sup>*1</sup> , ±4.9°C (-150 to -100°C) <sup>*1</sup> , ±7.2°C (-200 to -150°C) <sup>*1</sup>
	J	±2.8°C
	T	±3.1°C (0 to 350°C) <sup>*1</sup> , ±4.1°C (-100 to 0°C) <sup>*1</sup> , ±5.0°C (-150 to -100°C) <sup>*1</sup> , ±6.7°C (-200 to -150°C) <sup>*1</sup>
	B	±3.5°C
	R	±3.7°C
	S	±3.7°C
Ambient temperature -20 to 55°C	K	±6.5°C (-100 to +1200°C) <sup>*1</sup> , ±7.5°C (-150 to -100°C) <sup>*1</sup> , ±8.5°C (-200 to -150°C) <sup>*1</sup>
	J	±4.5°C
	T	±4.1°C (0 to 350°C) <sup>*1</sup> , ±5.1°C (-100 to 0°C) <sup>*1</sup> , ±6.0°C (-150 to -100°C) <sup>*1</sup> , ±7.7°C (-200 to -150°C) <sup>*1</sup>
	B	±6.5°C
	R	±6.5°C
	S	±6.5°C

\*1 The accuracy differs depending on the ranges of the measured temperature in ( ).

## 37.3 Procedure to Operate the System

The procedure to operate the system is described below.

1. Check the specifications of the analog adapter.

Check the specifications of the analog adapter. (☞ Page 650 Specifications)

2. Check the system configuration.

Check the system configuration. (☞ Page 650 System Configuration)

3. Install the analog adapter.

For restrictions on installation with the CPU module, combination of analog adapters, and order of connection, refer to the following manual.

📖 MELSEC iQ-F FX5S/FX5UJ/FX5U/FX5UC User's Manual (Hardware)

4. Connect the system to the external device.

Wiring to external devices. (☞ Page 659 Wiring)

5. Set the parameters.

Set the parameters such as analog adapter setting. (☞ Page 758 Parameter Setting)

6. Create the program.

Create the program to use the analog adapter.

7. Run the program.

### Precautions

Do not write to the special relay/special register in the user interrupt program.

## 37.4 Wiring

This section describes the wiring.

### European-type terminal block

For wiring to European-type terminal blocks, refer to the following.

📖 MELSEC iQ-F FX5S/FX5UJ/FX5U/FX5UC User's Manual (Hardware)

### Terminal layout

For the terminal layout, refer to the following.

📖 MELSEC iQ-F FX5S/FX5UJ/FX5U/FX5UC User's Manual (Hardware)

### Power supply wiring, analog wiring

For the power supply wiring, analog input wiring, analog output wiring, resistance temperature detector wiring, and thermocouple wiring, refer to the following.

📖 MELSEC iQ-F FX5S/FX5UJ/FX5U/FX5UC User's Manual (Hardware)

### Grounding

For grounding, refer to the following.

📖 MELSEC iQ-F FX5S/FX5UJ/FX5U/FX5UC User's Manual (Hardware)

## 37.5 List of Functions

The following table lists the functions list.

### Point

In the following explanation, the icons below indicate whether the corresponding analog adapter can be used in each function. (The functions cannot be used by analog adapters marked with ×.)

FX5-4A-ADP	FX5-4AD-ADP	FX5-4DA-ADP ×	FX5-4AD-PT-ADP ×	FX5-4AD-TC-ADP ×
------------	-------------	---------------	------------------	------------------

### Analog input

○: Supported, ×: Not supported

Item		Description	Availability		Reference
			FX5-4A-ADP	FX5-4AD-ADP	
A/D conversion enable/disable setting function		Controls whether to enable or disable the A/D conversion for each channel.	○	○	Page 666
Range switching function		Allows switching the input range of an analog input for each channel. Switching the range makes it possible to change the input conversion characteristics.	○	○	Page 667
A/D conversion method	Sampling processing	Sequentially A/D-converts the analog input values and stores the digital output values in a special register.	○	○	Page 669
	Averaging processing	Averages the digital output values for each channel and stores the average value in a special register. The following three types of averaging processing are provided. <ul style="list-style-type: none"> <li>• Time average</li> <li>• Count average</li> <li>• Moving average</li> </ul>	○	○	
Disconnection detection function		Disconnection can be detected for each channel.	○	○	Page 672
Over scale detection function		Function to detect analog input values that exceed an input range.	○	○	Page 674
Digital clipping function		Fixes a digital operation value to the maximum or minimum value of digital operation value output range when an input current or voltage exceeds the input range.	○	○	Page 676
Scaling function		Scales the digital output value within a range between the specified scaling upper limit value and scaling lower limit value. This function reduces the time and effort to create a program of the scale conversion.	○	○	Page 678
Warning output function	Process alarm	Outputs a warning when a digital operation value enters the preset alarm output range.	○	○	Page 682
	Rate alarm	Outputs a warning when the change rate of a digital output value is equal to or greater than the rate alarm upper limit value, or equal to or smaller than the rate alarm lower limit value.	○	○	
Shift function		Adds (shifts) the set conversion value shift amount to the digital output value and stores the result in the digital operation value. When the conversion value shift amount is changed, the change will be reflected in the digital operation value in real time, allowing fine adjustments to be easily performed during system startup.	○	○	Page 689
Convergence detection function		Detects whether the digital operation value is within a certain range for a specified time.	○	○	Page 691
Maximum value/minimum value hold function		Stores the maximum value and minimum value of the digital operation value to the special registers for each channel.	○	○	Page 693

Item	Description	Availability		Reference
		FX5-4A-ADP	FX5-4AD-ADP	
Deviation detection between channel function	Detects whether there is a difference of more than a certain level in digital operation values between channels.	○	○	Page 694
Offset/gain setting function	Corrects errors in digital output value.	○	○	Page 697
Offset/gain initialization function	Initializes the offset and gain values in the built-in memory.	○	○	Page 702

The functions are processed in the order shown below.

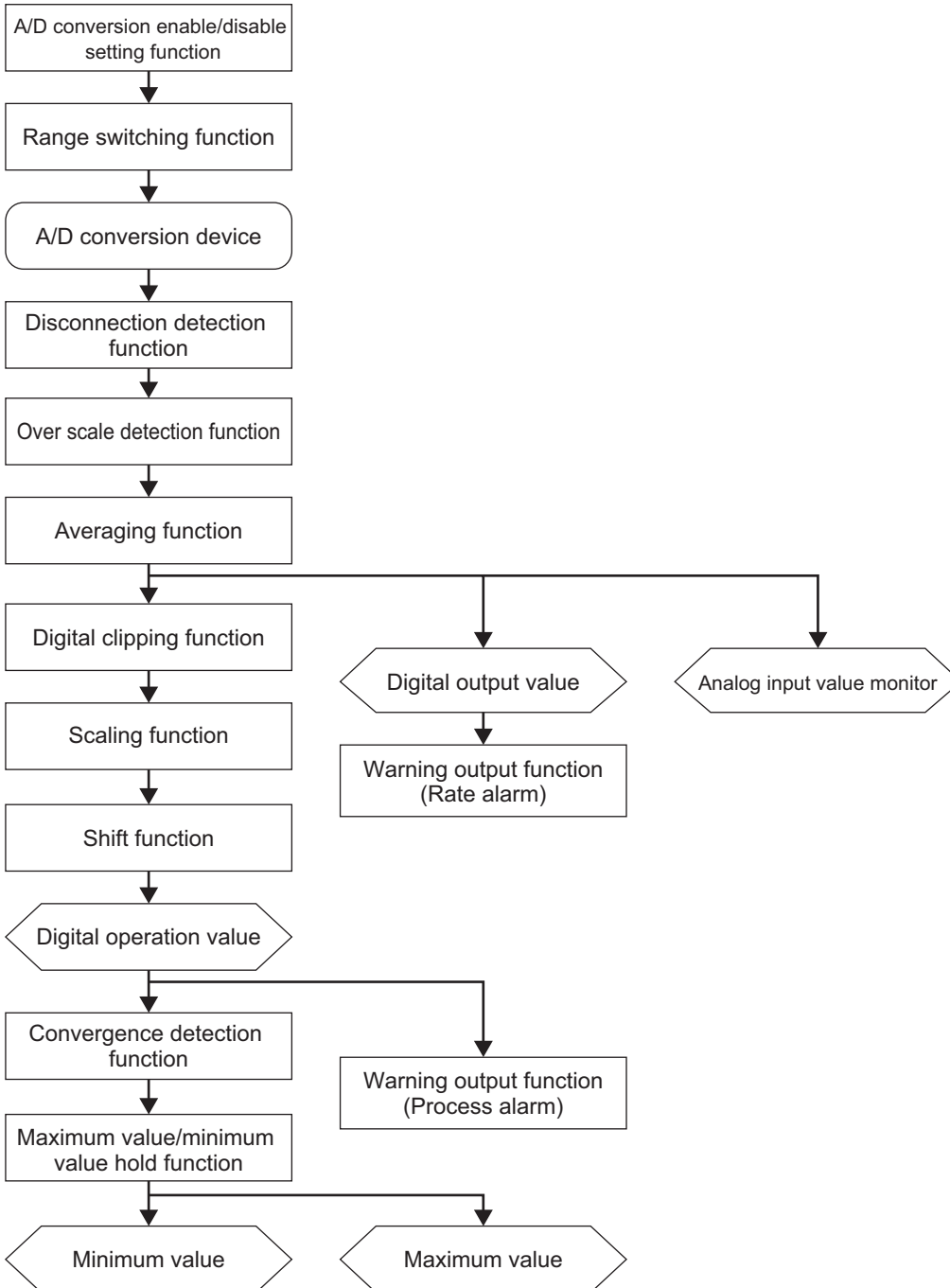

Item	Description
Digital output value	A digital value obtained by applying sampling processing or various types of averaging processing.
Digital operation value	A value obtained by operating a digital output value using the digital clipping function, scaling function, or shift function. When any of the functions is not used, the same value as the digital output value is stored.
Analog input value monitor	The input analog value is displayed. Voltage and current are displayed in the following units. Voltage: mV, Current: $\mu$ A
Maximum and minimum values	Stores the maximum and minimum values of the digital operation values.

## Analog output

○: Supported, ×: Not supported

Item	Description	Availability		Reference
		FX5-4A-ADP	FX5-4DA-ADP	
D/A conversion enable/disable setting function	Controls whether to enable or disable the D/A conversion for each channel.	○	○	Page 703
Range switching function	Allows switching the output range of an analog output for each channel. Switching the range makes it possible to change the output conversion characteristics.	○	○	Page 704
Shift function	Adds a set input value shifting amount to a digital value.	○	○	Page 705
Warning output function	Outputs a warning when the digital value exceeds the warning output upper limit value or becomes less than the warning output lower limit value.	○	○	Page 707
Scaling function	Performs scale conversion on digital values within a specified range between a scaling upper limit value and a scaling lower limit value. The program for scale conversion can be omitted.	○	○	Page 709
Analog output HOLD/CLEAR function	Sets whether to hold (HOLD) or clear (CLEAR) the analog output value that was being output when the operation status of the CPU module is RUN, STOP, or a stop error.	○	○	Page 711
D/A output enable/disable setting function	Specifies whether to output the D/A conversion value or offset value for each channel. The conversion speed is a constant, regardless of the output enable/disable status.	○	○	Page 712
Disconnection detection function	Monitors the analog output value and detects a disconnection.	○	○	Page 713
External power supply disconnection detection function	Detects that the external power supply 24 V DC is not supplied or is shut off.	○	○	Page 716
Offset/gain setting function	Corrects errors in D/A conversion values for each channel.	○	○	Page 716
Offset/gain initialization function	Initializes the offset and gain values in the built-in memory.	○	○	Page 721
Analog Output Test when CPU Module is in STOP Status Function	Analog output tests can be carried out when the CPU module is in the STOP status.	○	○	Page 722



The functions are processed in the order shown below.

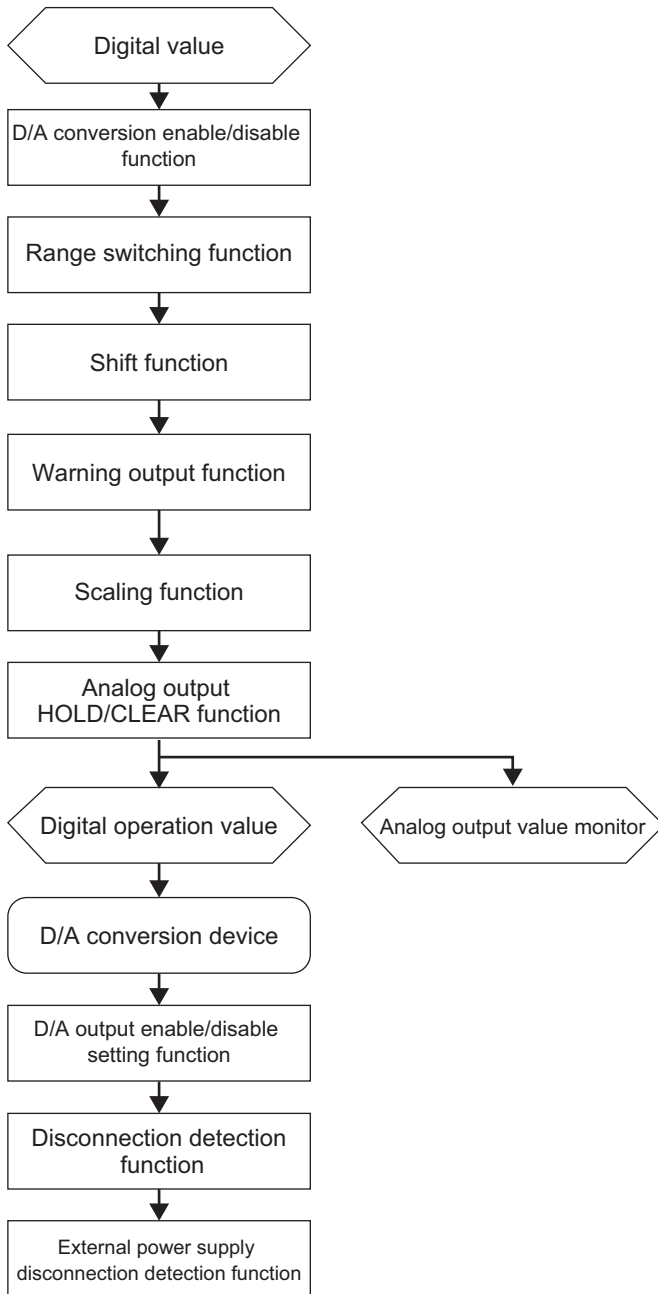

Item	Description
Digital value	Stores the input digital value.
Digital operation value	A value obtained by operating a digital value using the scaling function or shift function. When any of the functions is not used, the same value as the digital value is stored.
Analog output value monitor	The output analog value is displayed. Voltage and current are displayed in the following units. Voltage: mV, Current: $\mu$ A

## Temperature sensor input

○: Supported, ×: Not supported

Function list		Description	Availability		Reference
			FX5-4A-PT-ADP	FX5-4AD-TC-ADP	
Conversion enable/disable function		Sets whether to enable or disable the temperature conversion for each channel. Disabling the conversion on unused channels reduces the conversion cycles.	○	○	Page 724
Temperature resistance choice function		Sets a resistance temperature detector type for each channel. Selecting the resistance temperature detector type sets the input conversion characteristics.	○	×	Page 725
Thermocouple type choice function		Sets a thermocouple type for each channel. Selecting the thermocouple type sets the input conversion characteristics.	×	○	Page 727
Disconnection detection function		Performs disconnection detection for each channel.	○	○	Page 730
Temperature conversion method	Sampling processing	Executes the temperature conversion on analog input every END processing and stores the result as a measured temperature value in the special registers.	○	○	Page 733
	Averaging processing	Averages measured temperature values for each channel, and stores the average value in a special register. The following three types of averaging processing are provided. <ul style="list-style-type: none"> <li>• Time average</li> <li>• Count average</li> <li>• Moving average</li> </ul>			
Temperature unit choice function		Sets the temperature unit (Celsius/Fahrenheit) for each analog adapter.	○	○	Page 736
Maximum value/minimum value hold function		Stores the maximum and minimum values of measured temperature values to the special registers for each channel.	○	○	Page 737
Warning output function	Process alarm	Outputs an alarm when a measured temperature value enters the preset alarm output range.	○	○	Page 739
	Rate alarm	Outputs an alert when the change of a measured temperature value is equal to or greater than the rate alarm upper limit value, or equal to or smaller than the rate alarm lower limit value.			
Offset/gain setting function		Corrects errors in measured temperature value.	○	○	Page 746
Offset/gain initialization function		Initializes the offset and gain values in the built-in memory.	○	○	Page 752

The functions are processed in the order shown below.

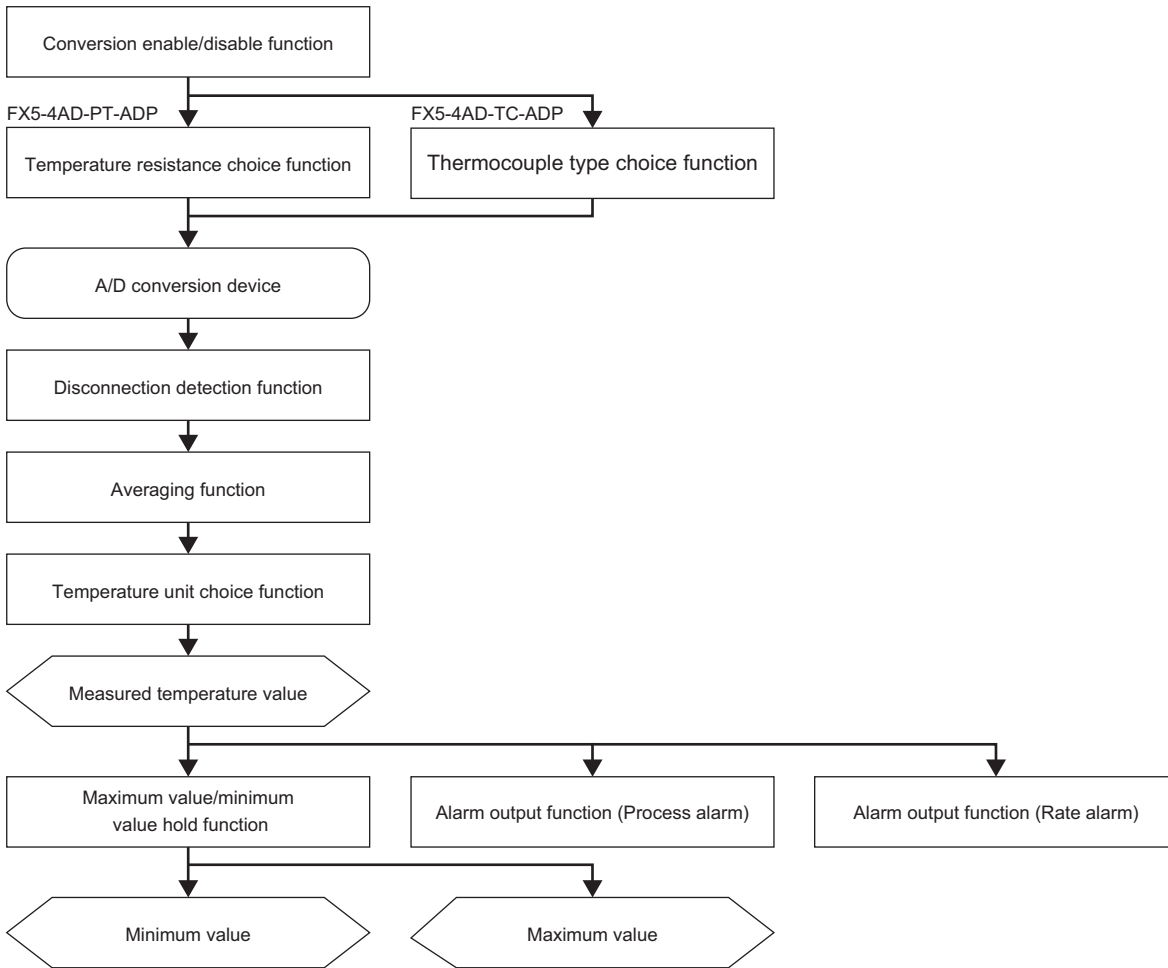

Item	Description
Measured temperature value	A digital value obtained by applying sampling processing and various types of averaging processing.
Maximum and minimum value	Stores the maximum and minimum values of the digital operation values.

### Others

○: Supported, ×: Not supported

Item	Description	Availability					Reference
		FX5-4A-ADP	FX5-4AD-ADP	FX5-4DA-ADP	FX5-4AD-PT-ADP	FX5-4AD-TC-ADP	
Event history function	Collects errors from the analog adapter, and stores them as event information in the CPU module.	○	○	○	○	○	Page 754
Changing the setting value while the CPU module is operating	Changes the parameters set by the engineering tool by using the special device.	○	○	○	○	○	Page 754
Starting/stopping the analog function in accordance with the CPU module status	The operation of the analog adapter can be checked by the CPU module.	○	○	○	○	○	Page 755
Alarm clear request	Clears the alarm code.	○	○	○	○	○	Page 756

## 37.6 Functions (Analog Input)

This section describes the A/D conversion functions and the setting procedures for those functions using the GX Works3.

### A/D conversion enable/disable setting function

FX5-4A-ADP

FX5-4AD-ADP

FX5-4DA-ADP

FX5-4AD-PT-ADP

FX5-4AD-TC-ADP

This function controls whether to enable or disable the A/D conversion for each channel.

#### Operation

The analog input is converted only for channel(s) whose "A/D conversion enable/disable setting" is set to enable A/D conversion, and the values are stored in the digital output value, digital operation value, and analog input value monitor. If "A/D conversion enable/disable setting" is changed from A/D conversion enable to A/D conversion disable, the digital value, digital operation value, and analog input value monitor will be cleared.

#### Setting procedure

Set "A/D conversion enable/disable setting" to "A/D conversion enable" or "A/D conversion disable".

Navigation window ⇒ [Parameter] ⇒ [Module Information] ⇒ Module model name ⇒ [Module Parameter] ⇒ "Basic Settings" ⇒ "A/D Conversion Enable/Disable Setting Function"

#### Corresponding devices

The devices which are used by the A/D conversion enable/disable setting function are listed below.

Name	Connection part	Special relay			
		CH1	CH2	CH3 <sup>*1</sup>	CH4 <sup>*1</sup>
A/D conversion enable/disable setting	1st adapter	SM6301	SM6341	SM6381	SM6421
	2nd adapter	SM6661	SM6701	SM6741	SM6781
	3rd adapter	SM7021	SM7061	SM7101	SM7141
	4th adapter	SM7381	SM7421	SM7461	SM7501

\*1 Only used by the FX5-4AD-ADP.

The details of the device used are listed below.

Name	Description	Setting value	Display description	Default value	R/W
A/D conversion enable/disable setting	Set whether to enable or disable A/D conversion.	0: OFF	A/D conversion enable	1: ON	R/W
		1: ON	A/D conversion disable		

# Range switching function

FX5-4A-ADP

FX5-4AD-ADP

FX5-4DA-ADP

FX5-4AD-PT-ADP

FX5-4AD-TC-ADP

This function allows switching the input range of an analog input for each channel.  
Switching the range makes it possible to change the input conversion characteristics.

## Operation

The input range is switched when the "input range setting" is changed while the "A/D conversion enable/disable setting" is set to "disable".

When the input range is switched, the following special devices are initialized:

Name	Connection part	Special device			
		CH1	CH2	CH3*1	CH4*1
A/D conversion completed flag	1st adapter	SM6300	SM6340	SM6380	SM6420
	2nd adapter	SM6660	SM6700	SM6740	SM6780
	3rd adapter	SM7020	SM7060	SM7100	SM7140
	4th adapter	SM7380	SM7420	SM7460	SM7500
Over scale upper limit detection flag	1st adapter	SM6302	SM6342	SM6382	SM6422
	2nd adapter	SM6662	SM6702	SM6742	SM6782
	3rd adapter	SM7022	SM7062	SM7102	SM7142
	4th adapter	SM7382	SM7422	SM7462	SM7502
Over scale lower limit detection flag	1st adapter	SM6303	SM6343	SM6383	SM6423
	2nd adapter	SM6663	SM6703	SM6743	SM6783
	3rd adapter	SM7023	SM7063	SM7103	SM7143
	4th adapter	SM7383	SM7423	SM7463	SM7503
Warning output flag (process alarm upper limit)	1st adapter	SM6311	SM6351	SM6391	SM6431
	2nd adapter	SM6671	SM6711	SM6751	SM6791
	3rd adapter	SM7031	SM7071	SM7111	SM7151
	4th adapter	SM7391	SM7431	SM7471	SM7511
Warning output flag (process alarm lower limit)	1st adapter	SM6312	SM6352	SM6392	SM6432
	2nd adapter	SM6672	SM6712	SM6752	SM6792
	3rd adapter	SM7032	SM7072	SM7112	SM7152
	4th adapter	SM7392	SM7432	SM7472	SM7512
Warning output flag (rate alarm upper limit)	1st adapter	SM6315	SM6355	SM6395	SM6435
	2nd adapter	SM6675	SM6715	SM6755	SM6795
	3rd adapter	SM7035	SM7075	SM7115	SM7155
	4th adapter	SM7395	SM7435	SM7475	SM7515
Warning output flag (rate alarm lower)	1st adapter	SM6316	SM6356	SM6396	SM6436
	2nd adapter	SM6676	SM6716	SM6756	SM6796
	3rd adapter	SM7036	SM7076	SM7116	SM7156
	4th adapter	SM7396	SM7436	SM7476	SM7516
Disconnection detection flag	1st adapter	SM6318	SM6358	SM6398	SM6438
	2nd adapter	SM6678	SM6718	SM6758	SM6798
	3rd adapter	SM7038	SM7078	SM7118	SM7158
	4th adapter	SM7398	SM7438	SM7478	SM7518
Convergence detection flag	1st adapter	SM6321	SM6361	SM6401	SM6441
	2nd adapter	SM6681	SM6721	SM6761	SM6801
	3rd adapter	SM7041	SM7081	SM7121	SM7161
	4th adapter	SM7401	SM7441	SM7481	SM7521

Name	Connection part	Special device			
		CH1	CH2	CH3*1	CH4*1
Deviation detection flag between channel	1st adapter	SM6325	SM6365	SM6405	SM6445
	2nd adapter	SM6685	SM6725	SM6765	SM6805
	3rd adapter	SM7045	SM7085	SM7125	SM7165
	4th adapter	SM7405	SM7445	SM7485	SM7525
Digital output value	1st adapter	SD6300	SD6340	SD6380	SD6420
	2nd adapter	SD6660	SD6700	SD6740	SD6780
	3rd adapter	SD7020	SD7060	SD7100	SD7140
	4th adapter	SD7380	SD7420	SD7460	SD7500
Digital operation value	1st adapter	SD6301	SD6341	SD6381	SD6421
	2nd adapter	SD6661	SD6701	SD6741	SD6781
	3rd adapter	SD7021	SD7061	SD7101	SD7141
	4th adapter	SD7381	SD7421	SD7461	SD7501
Analog input value monitor	1st adapter	SD6302	SD6342	SD6382	SD6422
	2nd adapter	SD6662	SD6702	SD6742	SD6782
	3rd adapter	SD7022	SD7062	SD7102	SD7142
	4th adapter	SD7382	SD7422	SD7462	SD7502
Maximum value	1st adapter	SD6306	SD6346	SD6386	SD6426
	2nd adapter	SD6666	SD6706	SD6746	SD6786
	3rd adapter	SD7026	SD7066	SD7106	SD7146
	4th adapter	SD7386	SD7426	SD7466	SD7506
Minimum value	1st adapter	SD6307	SD6347	SD6387	SD6427
	2nd adapter	SD6667	SD6707	SD6747	SD6787
	3rd adapter	SD7027	SD7067	SD7107	SD7147
	4th adapter	SD7387	SD7427	SD7467	SD7507
Offset setting value*2	1st adapter	SD6332	SD6372	SD6412	SD6452
	2nd adapter	SD6692	SD6732	SD6772	SD6812
	3rd adapter	SD7052	SD7092	SD7132	SD7172
	4th adapter	SD7412	SD7452	SD7492	SD7532
Gain setting value*2	1st adapter	SD6333	SD6373	SD6413	SD6453
	2nd adapter	SD6693	SD6733	SD6773	SD6813
	3rd adapter	SD7053	SD7093	SD7133	SD7173
	4th adapter	SD7413	SD7453	SD7493	SD7533

\*1 Only used by the FX5-4AD-ADP.

\*2 When the input range setting after change is equivalent to the input range setting set by the offset/gain setting function, the values set by the offset/gain setting function are reflected. In any other case, they are initialized to the initial value.

## Setting procedure

Set the input range to be used in the "Input range setting".

 Navigation window ⇒ [Parameter] ⇒ [Module Information] ⇒ Module model name ⇒ [Module Parameter] ⇒ "Basic Settings" ⇒ "Range switching function"

Input range setting	Digital output value
0 to 10V	0 to 16000
0 to 5V	0 to 16000
1 to 5V	0 to 12800
-10 to +10V	-8000 to +8000
0 to 20mA	0 to 16000
4 to 20mA	0 to 12800
-20 to +20mA	-8000 to +8000

## Corresponding devices

The devices which are used by the range switching function are listed below.

Name	Connection part	Special register			
		CH1	CH2	CH3*1	CH4*1
Input range setting	1st adapter	SD6305	SD6345	SD6385	SD6425
	2nd adapter	SD6665	SD6705	SD6745	SD6785
	3rd adapter	SD7025	SD7065	SD7105	SD7145
	4th adapter	SD7385	SD7425	SD7465	SD7505

\*1 Only used by the FX5-4AD-ADP.

The details of the device used are listed below.

Name	Description	Setting value	Description	Default value	R/W
Input range setting	Set the input range. If a value other than the setting value is set, the range setting range error (error code: 1A8□H) occurs.	0	0 to 10V	0	R/W
		1	0 to 5V		
		2	1 to 5V		
		3	-10 to +10V		
		4	0 to 20mA		
		5	4 to 20mA		
		6	-20 to +20mA		

## A/D conversion method

FX5-4A-ADP

FX5-4AD-ADP

FX5-4DA-ADP

FX5-4AD-PT-ADP

FX5-4AD-TC-ADP

An A/D conversion method can be set for each channel.

## Sampling processing

The analog input is A/D-converted in each scan of the CPU module, the converted value is output in digital at each time, and values are stored in the digital output value, digital operation value and analog input value monitor.

## Averaging processing

The module averages the digital output values for each channel and stores the average value in a special register.

The following three types of averaging processing are provided.

- Time average
- Count average
- Moving average

### ■Time average

A/D conversion is executed for a set time, the total value is averaged, and values are stored in the digital output value, digital operation value, and analog input value monitor.

The number of times of processing within the set time varies depending on the number of channels for which A/D conversion is enabled.

Number of processing times = Setting time ÷ Scan time

### Point

If the set time is shorter than the scan time, the averaging processing is not executed, but the sampling value is output. However, only in the first output, the averaged value of the 1st sample and 2nd sample is output.

## Count average

A/D conversion is executed for a set number of times of count average, the averaged value excluding the maximum value and minimum value is output in digital, and values are stored in the digital output value, digital operation value, and analog input value monitor.

The time required to store the averaged value obtained by count average in the digital output value, digital operation value, and analog input value monitor varies depending on the scan time.

Processing time = Set number of times × Scan time

### Point

The count average requires a total of at least two values excluding the maximum value and minimum value. Set the number of times to "4" or larger value.

## Moving average

The number of times of moving average processing of A/D conversion values can be specified, and the averaged value is output in digital, and values are stored in the digital output value, digital operation value, and analog input value monitor.

Because the target range for averaging processing is moved in each scan and the averaging processing is executed using A/D conversion values for the set number of times, the latest digital output value, digital operation value, and analog input value monitor can be obtained. The figure below shows the moving average when the number of times of averaging processing is set to "4".

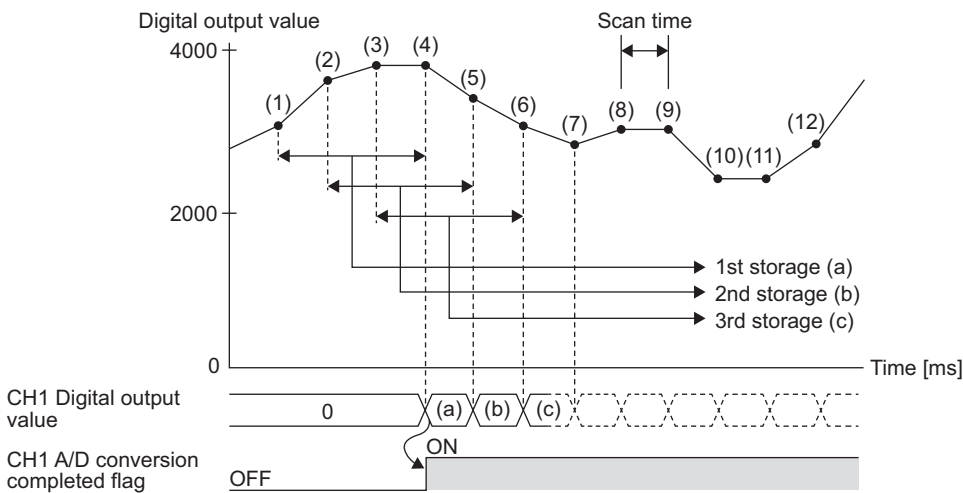

## Setting procedure

Set "Average Processing Specification".

Navigation window ⇒ [Parameter] ⇒ [Module Information] ⇒ Module model name ⇒ "Basic Settings" ⇒ "A/D conversion method"

Item	Description	Setting description	Default
Average processing setting	Selects the A/D conversion method.	<ul style="list-style-type: none"> <li>• Sampling Processing</li> <li>• Time Average</li> <li>• Count Average</li> <li>• Moving Average</li> </ul>	Sampling Processing
Time Average Counts Average Moving Average*1	Sets the time average.	1 to 10000 (ms)	0
	Sets the count average.	4 to 32767 (times)	0
	Sets the moving average.	2 to 64 (times)	0

\*1 Set this item when "Time Average", "Count Average", or "Moving Average" is selected in "Average Processing Specification".



## Corresponding devices

The devices which are used by the A/D conversion method are listed below.

Name	Connection part	Special register			
		CH1	CH2	CH3*1	CH4*1
Digital output value	1st adapter	SD6300	SD6340	SD6380	SD6420
	2nd adapter	SD6660	SD6700	SD6740	SD6780
	3rd adapter	SD7020	SD7060	SD7100	SD7140
	4th adapter	SD7380	SD7420	SD7460	SD7500
Digital operation value	1st adapter	SD6301	SD6341	SD6381	SD6421
	2nd adapter	SD6661	SD6701	SD6741	SD6781
	3rd adapter	SD7021	SD7061	SD7101	SD7141
	4th adapter	SD7381	SD7421	SD7461	SD7501
Analog input value monitor	1st adapter	SD6302	SD6342	SD6382	SD6422
	2nd adapter	SD6662	SD6702	SD6742	SD6782
	3rd adapter	SD7022	SD7062	SD7102	SD7142
	4th adapter	SD7382	SD7422	SD7462	SD7502
Average processing specify	1st adapter	SD6303	SD6343	SD6383	SD6423
	2nd adapter	SD6663	SD6703	SD6743	SD6783
	3rd adapter	SD7023	SD7063	SD7103	SD7143
	4th adapter	SD7383	SD7423	SD7463	SD7503
Time Average/Count Average/Moving Average setting	1st adapter	SD6304	SD6344	SD6384	SD6424
	2nd adapter	SD6664	SD6704	SD6744	SD6784
	3rd adapter	SD7024	SD7064	SD7104	SD7144
	4th adapter	SD7384	SD7424	SD7464	SD7504

\*1 Only used by the FX5-4AD-ADP.

The details of the device used are listed below.

Name	Description	Range	Default value	R/W
Digital output value	The A/D converted digital output value is stored. The value is updated in every averaging processing cycle when the averaging processing is executed, or in every sampling cycle when the averaging processing is not executed.	-8192 to +16383	0	R
Digital operation value	The digital operation value operated by the scaling function, shift function, and digital clipping function is stored. The same value as the digital output value is stored when the scaling function, shift function, and digital clipping function are not used.	-32768 to +32767	0	R
Analog input value monitor	The input analog value is stored. The unit of analog value is mV for voltage input and $\mu$ A for current input.	-20480 to +20479	0	R

Name	Description	Setting value	Description	Default value	R/W
Average processing setting	Set which one between the sampling processing and the averaging processing is to be selected. The averaging processing is classified into "time average", "count average" and "moving average". If a value other than the set value is set, the averaging processing setting range error (error code: 1A0□H) occurs.	0	Sampling processing	0	R/W
		1	Time average		
		2	Count average		
		3	Moving average		
Time average/count average/moving average	Set the average time, average counts and moving average counts in the averaging processing for each channel. If a value other than the set value is set, one of the following will occur and A/D conversion processing will be performed with the setting before the error. • Average time setting range error (error code: 1A1□H) • Average count setting range error (error code: 1A2□H) • Moving average count setting range error (error code: 1A3□H)	1 to 10000 (ms)	Time average	0	R/W
		4 to 32767 (times)	Count average		
		2 to 64 (times)	Moving average		

# Disconnection detection function

FX5-4A-ADP
FX5-4AD-ADP
FX5-4DA-ADP
FX5-4AD-PT-ADP
FX5-4AD-TC-ADP

Simple disconnection detection is performed.  
 This function is enabled when the analog input range is 1 to 5 V or 4 to 20 mA.

## Disconnection detection condition

The table below shows the disconnection detection condition and disconnection recovery condition.

Input range	Disconnection detection condition	Disconnection recovery condition
1 to 5V	Analog input value $\leq 0.5$ V	Analog input value $> 0.5$ V
4 to 20mA	Analog input value $\leq 2$ mA	Analog input value $> 2$ mA

## Operation

When the following conditions are met, a disconnection is determined, an alarm is generated, and the "disconnection detection flag" turns ON. (Alarm code: 0A0□H)

- For channels where A/D conversion is enabled in "A/D conversion enable/disable setting" and "disconnection detection enable/disable setting" is set to "enable", the input voltage or input current reaches their disconnection detection condition. The A/D conversion completion flag" turns OFF, A/D conversion is interrupted, and the later processing is not executed in the disconnected channel.
- When the "disconnection recovery detection enable/disable setting" is set to "enable", the "disconnection detection flag" turns OFF when the channel is recovered from disconnection. When the channel is recovered from disconnection, A/D conversion is restarted.
- When the "disconnection recovery detection enable/disable setting" is set to "disable", the "disconnection detection flag" remains ON. To turn OFF "disconnection detection flag", it is necessary to turn ON "A/D conversion alarm clear request" ("Alarm clear request" for the FX5-4AD-ADP). The "disconnection detection flag" turns OFF also when the "disconnection detection enable/disable setting" is changed to "disable".

The range setting range error with disconnection detection enabled (Error code: 1AA□H) occurs when the input range of a channel for which the "disconnection detection enable/disable setting" is set to "enable" is set outside "1 to 5V" or "4 to 20mA".

### ■When the "disconnection detection recovery enable/disable setting" is set to "enable"

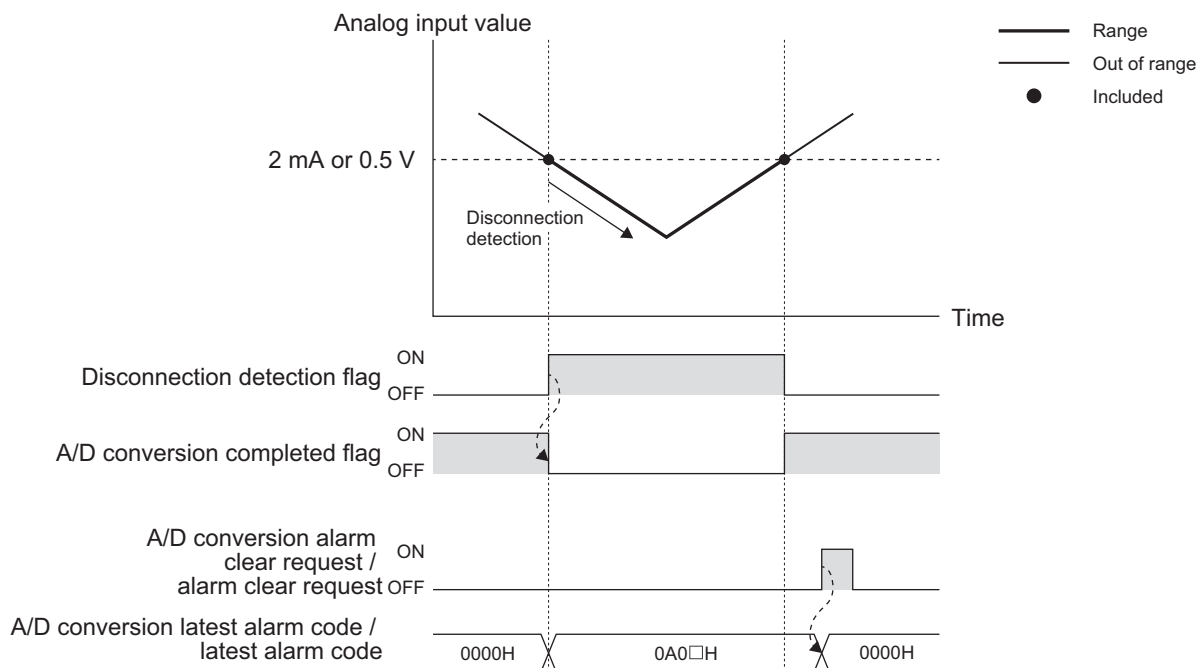

## Point

- The "disconnection detection flag" automatically turns OFF.
- To clear "A/D conversion latest alarm code", turn ON "A/D conversion alarm clear request" ("Alarm clear request" for the FX5-4AD-ADP).

### ■When the "disconnection detection recovery enable/disable setting" is set to "disable"

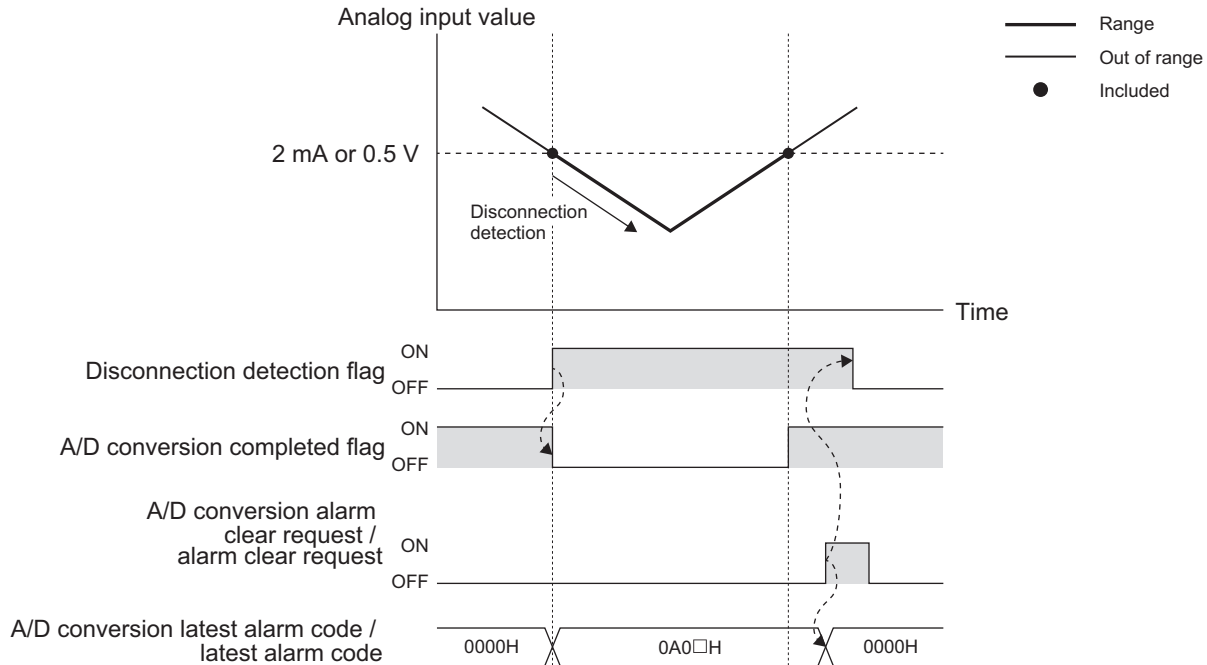

37

## Point

- The "disconnection detection flag" does not automatically turn OFF. To turn OFF this flag, turn ON "A/D conversion alarm clear request" ("Alarm clear request" for the FX5-4AD-ADP).
- To clear "A/D conversion latest alarm code", turn ON "A/D conversion alarm clear request" ("Alarm clear request" for the FX5-4AD-ADP).

## Setting procedure

1. Set "Disconnection detection enable/disable setting" to "Enable".

Navigation window ⇒ [Parameter] ⇒ [Module Information] ⇒ Module model name ⇒ [Module Parameter] ⇒ "Application Settings" ⇒ "Disconnection detection enable/disable setting"

2. Set "Disconnection recovery detection enable/disable setting".

Navigation window ⇒ [Parameter] ⇒ [Module Information] ⇒ Module model name ⇒ [Module Parameter] ⇒ "Application Settings" ⇒ "Disconnection recovery detection enable/disable setting"

## Corresponding devices

The devices which are used by the disconnection detection function are listed below.

Name	Connection part	Special relay			
		CH1	CH2	CH3*1	CH4*1
Disconnection detection flag	1st adapter	SM6318	SM6358	SM6398	SM6438
	2nd adapter	SM6678	SM6718	SM6758	SM6798
	3rd adapter	SM7038	SM7078	SM7118	SM7158
	4th adapter	SM7398	SM7438	SM7478	SM7518
Disconnection detection enable/disable setting	1st adapter	SM6319	SM6359	SM6399	SM6439
	2nd adapter	SM6679	SM6719	SM6759	SM6799
	3rd adapter	SM7039	SM7079	SM7119	SM7159
	4th adapter	SM7399	SM7439	SM7479	SM7519
Disconnection recovery detection enable/disable setting	1st adapter	SM6320	SM6360	SM6400	SM6440
	2nd adapter	SM6680	SM6720	SM6760	SM6800
	3rd adapter	SM7040	SM7080	SM7120	SM7160
	4th adapter	SM7400	SM7440	SM7480	SM7520

\*1 Only used by the FX5-4AD-ADP.

The details of the device used are listed below.

Name	Description	Monitor value	Display description	Default value	R/W
Disconnection detection flag	This flag monitors the disconnection detection.	0: OFF	Normal	0: OFF	R
		1: ON	Disconnection detection		
Disconnection detection enable/disable setting	Set whether to enable or disable the disconnection detection function.	0: OFF	Disconnection detection enable	1: ON	R/W
		1: ON	Disconnection detection disable		
Disconnection recovery detection enable/disable setting	Set whether to enable or disable the disconnection detection recovery.	0: OFF	Disconnection recovery detection enable	1: ON	R/W
		1: ON	Disconnection recovery detection disable		

## Over scale detection function

FX5-4A-ADP

FX5-4AD-ADP

FX5-4DA-ADP

FX5-4AD-PT-ADP

FX5-4AD-TC-ADP

This function detects analog input values that exceed an input range.

### Over-scale detection condition

The table below shows the condition for detecting over-scale when the over-scale detection function is enabled.

Input range	Normal range	Over-scale detection condition	
		Analog input value lower limit	Analog input value upper limit
0 to 10V	-0.2 to +10.2V	-0.2V > Analog input value	+10.2V < Analog input value
0 to 5V	-0.1 to +5.1V	-0.1V > Analog input value	+5.1V < Analog input value
1 to 5V	-0.1 to +5.1V	-0.1V > Analog input value	+5.1V < Analog input value
-10 to +10V	-10.2 to +10.2V	-10.2V > Analog input value	+10.2V < Analog input value
0 to 20mA	-0.4 to +20.4mA	-0.4mA > Analog input value	+20.4mA < Analog input value
4 to 20mA	-0.4 to +20.4mA	-0.4mA > Analog input value	+20.4mA < Analog input value
-20 to +20mA	-20.4 to +20.4mA	-20.4mA > Analog input value	+20.4mA < Analog input value

## Operation

When the analog input value is outside the normal range, it is regarded as over-scale and the corresponding over-scale detection flag turns ON.

- Over-scale upper limit detection flag: Turns ON when the analog input value is above the normal range. (Alarm code: 090□H)
- Over-scale lower limit detection flag: Turns ON when the analog input value is below the normal range. (Alarm code: 091□H)

For the channel in which over-limit is detected, the digital output value before over-limit is stored, and "A/D conversion complete flag" turns OFF for this channel.

When the analog input value becomes normal, A/D conversion is restarted. After the first update, the "A/D conversion completion flag" of the corresponding channel turns ON, At this time, the "over-scale upper limit detection flag" and "over-scale lower limit detection flag" do not turn OFF.

To turn OFF "over-scale upper limit detection flag" and "over-scale lower limit detection flag", it is necessary to turn ON "A/D conversion alarm clear request" ("Alarm clear request" for the FX5-4AD-ADP). The "over-scale upper limit detection flag", "over-scale lower limit detection flag" turns OFF also when the "over-scale detection enable/disable" is changed to "disable".

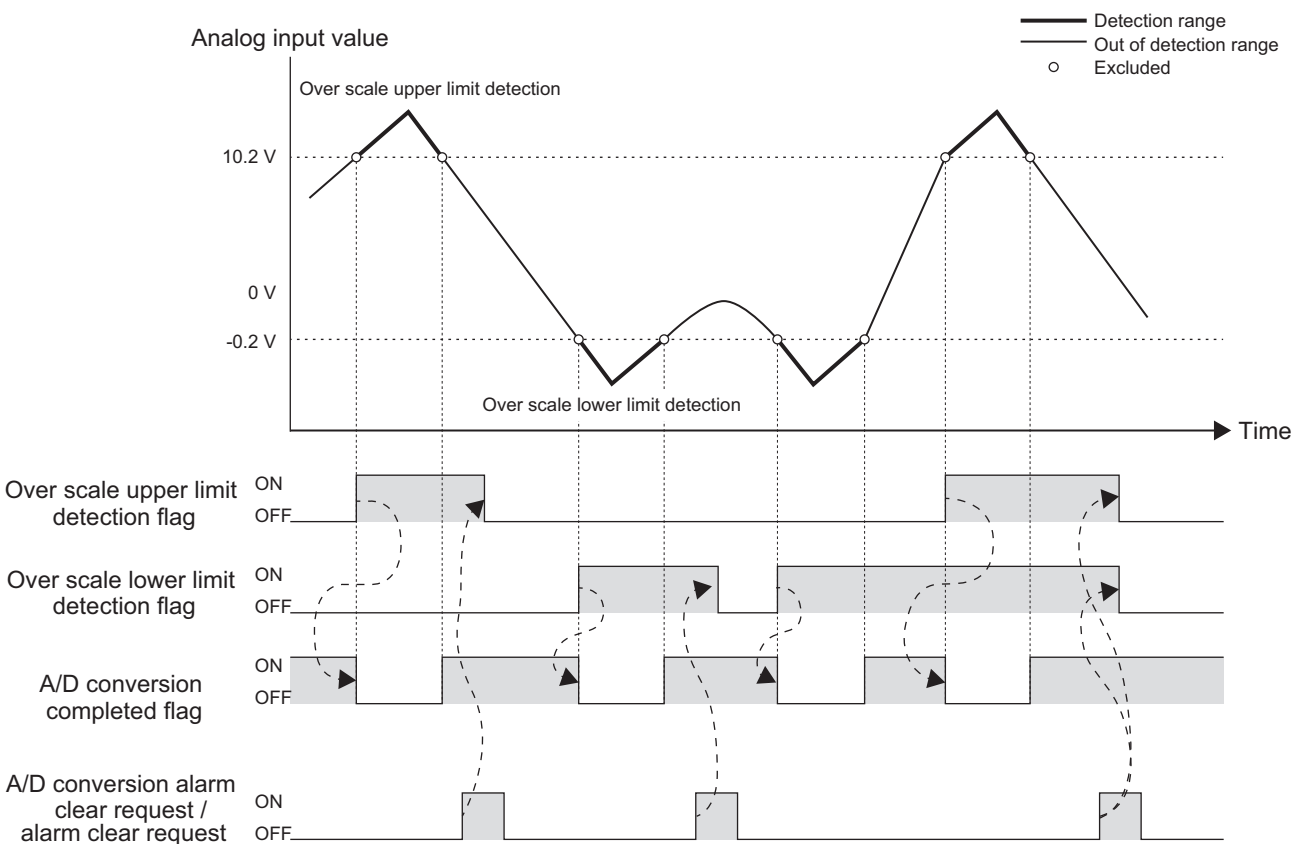

### Point

- "A/D conversion alarm clear request" ("Alarm clear request" for the FX5-4AD-ADP) does not turn OFF automatically. To perform an alarm clear again, it is necessary to turn it OFF once.
- To clear the alarm code, turn ON "A/D conversion alarm clear request" ("Alarm clear request" for the FX5-4AD-ADP).

## Setting procedure

Set "Over scale detection enable/disable" to "Enable".

Navigation window ⇒ [Parameter] ⇒ [Module Information] ⇒ Module [model name] ⇒ [Module Parameter] ⇒ "Application Settings" ⇒ "Over Scale Detection"

## Corresponding devices

The devices which are used by the over scale detection function are listed below.

Name	Connection part	Special relay			
		CH1	CH2	CH3 <sup>*1</sup>	CH4 <sup>*1</sup>
Over scale upper limit detection flag	1st adapter	SM6302	SM6342	SM6382	SM6422
	2nd adapter	SM6662	SM6702	SM6742	SM6782
	3rd adapter	SM7022	SM7062	SM7102	SM7142
	4th adapter	SM7382	SM7422	SM7462	SM7502
Over scale lower limit detection flag	1st adapter	SM6303	SM6343	SM6383	SM6423
	2nd adapter	SM6663	SM6703	SM6743	SM6783
	3rd adapter	SM7023	SM7063	SM7103	SM7143
	4th adapter	SM7383	SM7423	SM7463	SM7503
Over scale detection enable/disable setting	1st adapter	SM6304	SM6344	SM6384	SM6424
	2nd adapter	SM6664	SM6704	SM6744	SM6784
	3rd adapter	SM7024	SM7064	SM7104	SM7144
	4th adapter	SM7384	SM7424	SM7464	SM7504

\*1 Only used by the FX5-4AD-ADP.

The details of the device used are listed below.

Name	Description	Monitor value	Display description	Default value	R/W
Over scale upper limit detection flag	This flag monitors the over-scale upper limit detection status in the over-scale detection function.	0: OFF	Normal	0: OFF	R
		1: ON	Over scale upper limit detection		
Over scale lower limit detection flag	This flag monitors the over-scale lower limit detection status in the over-scale detection function.	0: OFF	Normal	0: OFF	R
		1: ON	Over scale lower limit detection		
Over scale detection enable/disable setting	Set whether to enable or disable over scale detection.	0: OFF	Over scale detection enable	1: ON	R/W
		1: ON	Over scale detection disable		

## Digital clipping function



This function fixes the digital operation value to the maximum or minimum value of the digital operation value output range when the input current or voltage exceeds the input range.

## List of output ranges

In each range below, the output range of digital operation values when the digital clipping function is enabled is shown.

Input range	Output range of digital operation values		
	Digital clipping function enabled	Digital clipping function disabled (over scale enabled)	Digital clipping function disabled
0 to 10V	0 to 16000	-320 to +16320	-384 to +16383
0 to 5V			
1 to 5V	0 to 12800	-3520 to +13120	-3584 to +13183
-10 to +10V	-8000 to +8000	-8160 to +8160	-8192 to +8191
0 to 20mA	0 to 16000	-320 to +16320	-384 to +16383
4 to 20mA	0 to 12800	-3520 to +13120	-3584 to +13183
-20 to +20mA	-8000 to +8000	-8160 to +8160	-8192 to +8191

## Setting procedure

Set "Digital Clip Enable/Disable" to "enable".

Navigation window ⇒ [Parameter] ⇒ [Module Information] ⇒ Module model name ⇒ [Module Parameter] ⇒ "Application Settings" ⇒ "Digital Clip Setting"

## Setting example

Ex.

When the following values are used for the channel with the input range of 0 to 10V

### ■Setting value

- Scaling upper limit value: 12000
- Scaling lower limit value: 2000
- Conversion value shift amount: 2000
- Digital clip enable/disable setting: enable

### ■Setting procedure

1. Set the "A/D conversion enable/disable setting" to "enable".
2. Set "2000" to the scaling lower limit value.
3. Set "12000" to the scaling upper limit value.
4. Set the "scaling enable/disable setting" to "enable".
5. Set "2000" to the conversion value shift amount.
6. Set "Digital clipping enable/disable setting" to "enable".

### ■Operation

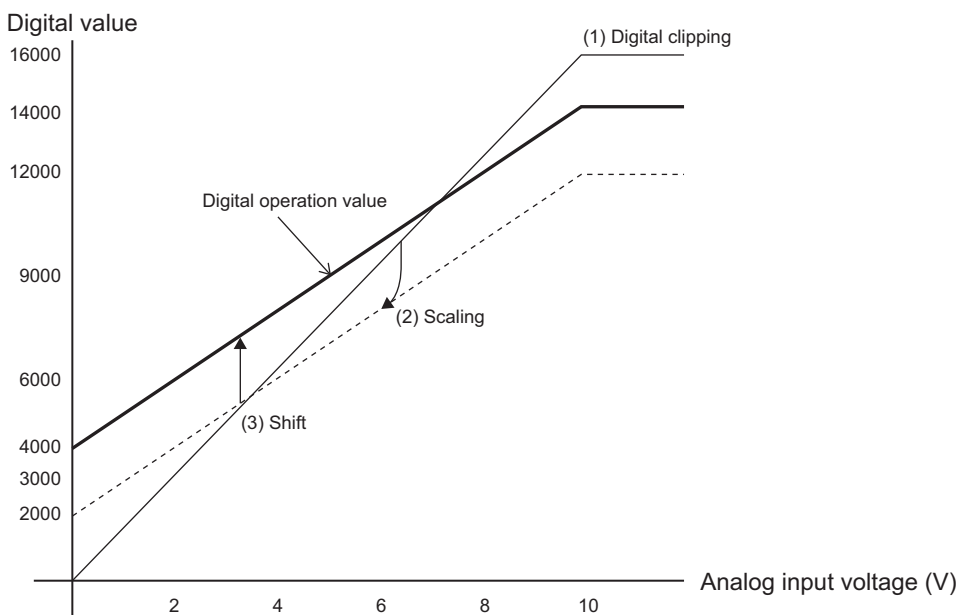

## Corresponding devices

The devices which are used by the digital clipping function are listed below.

Name	Connection part	Special relay			
		CH1	CH2	CH3*1	CH4*1
Digital clipping enable/disable setting	1st adapter	SM6309	SM6349	SM6389	SM6429
	2nd adapter	SM6669	SM6709	SM6749	SM6789
	3rd adapter	SM7029	SM7069	SM7109	SM7149
	4th adapter	SM7389	SM7429	SM7469	SM7509

\*1 Only used by the FX5-4AD-ADP.

The details of the device used are listed below.

Name	Description	Setting value	Description	Default value	R/W
Digital clipping enable/disable setting	Sets whether to enable or disable the digital clipping function.	0: OFF	Digital clipping function enable	1: ON	R/W
		1: ON	Digital clipping function disable		

## Scaling function



This function performs the scale conversion on digital output values within a specified range between a scaling upper limit value and a scaling lower limit value.

The scaled value is stored in "Digital operation value".

### Operation

#### ■ Concept of scaling setting

**Ex.**

When the input range is set to -10 to +10V:

For the scaling lower limit value, set a value corresponding to the lower limit value of the input range (-8000).

For the scaling upper limit value, set a value corresponding to the upper limit value of the input range (+8000).

#### ■ Calculating the scaling value

The scale conversion is based on the following formula. (The value below the decimal point obtained by scale conversion is rounded off.)

- For current (0 to 20mA, 4 to 20mA), voltage (0 to 10V, 0 to 5V, 1 to 5V)

Calculation formula	Symbol
$D_Y = \frac{D_X \times (S_H - S_L)}{D_{Max}} + S_L$	<p><math>D_X</math>: Digital output value</p> <p><math>D_Y</math>: Scaling value (digital operation value)</p> <p><math>D_{Max}</math>: Maximum value of digital output for the input range in use</p> <p><math>S_H</math>: Scaling upper limit value</p> <p><math>S_L</math>: Scaling lower limit value</p>

- For current (-20 to +20mA), voltage (-10 to +10V)

Calculation formula	Symbol
$D_Y = \frac{D_X \times (S_H - S_L)}{D_{Max} - D_{Min}} + \frac{(S_H + S_L)}{2}$	<p><math>D_X</math>: Digital output value</p> <p><math>D_Y</math>: Scaling value (digital operation value)</p> <p><math>D_{Max}</math>: Maximum value of digital output for the input range in use</p> <p><math>D_{Min}</math>: Minimum value of digital output for the input range in use</p> <p><math>S_H</math>: Scaling upper limit value</p> <p><math>S_L</math>: Scaling lower limit value</p>



## Setting procedure

1. Set "Scaling enable/disable setting" to "Enable".

Navigation window ⇒ [Parameter] ⇒ [Module Information] ⇒ Module model name ⇒ [Module Parameter] ⇒ "Application Settings" ⇒ "Scaling Setting"

2. Set values for "Scaling upper limit value" and "Scaling lower limit value".

Item	Setting range
Scaling upper limit value	-32768 to +32767
Scaling lower limit value	-32768 to +32767

### Point

- Even when the scaling upper limit value and the scaling lower limit value are set so that the change is greater than the resolution, the max. resolution will not increase.
- If the relation between the values is scaling lower limit value > scaling upper limit value, the scale conversion can be performed according to a negative slope.
- Set the scaling with the condition "Scaling lower limit value ≠ Scaling upper limit value".

37

## Corresponding devices

The devices which are used by the scaling function are listed below.

Name	Connection part	Special relay			
		CH1	CH2	CH3*1	CH4*1
Scaling enable/disable setting	1st adapter	SM6308	SM6348	SM6388	SM6428
	2nd adapter	SM6668	SM6708	SM6748	SM6788
	3rd adapter	SM7028	SM7068	SM7108	SM7148
	4th adapter	SM7388	SM7428	SM7468	SM7508
Scaling upper limit value	1st adapter	SD6308	SD6348	SD6388	SD6428
	2nd adapter	SD6668	SD6708	SD6748	SD6788
	3rd adapter	SD7028	SD7068	SD7108	SD7148
	4th adapter	SD7388	SD7428	SD7468	SD7508
Scaling lower limit value	1st adapter	SD6309	SD6349	SD6389	SD6429
	2nd adapter	SD6669	SD6709	SD6749	SD6789
	3rd adapter	SD7029	SD7069	SD7109	SD7149
	4th adapter	SD7389	SD7429	SD7469	SD7509

\*1 Only used by the FX5-4AD-ADP.

The details of the device used are listed below.

Name	Description	Setting value	Description	Default value	R/W
Scaling enable/disable setting	Set whether to enable or disable the scaling function.	0: OFF	Scaling function enable	1: ON	R/W
		1: ON	Scaling function disable		
Name	Description	Range	Default value	R/W	
Scaling upper limit value Scaling lower limit value	Set the upper and lower limit values of the scaling conversion range.	-32768 to +32767	0	R/W	

## Setting example

**Ex.**

When 5000 is set to the scaling upper limit value and 1000 is set to the scaling lower limit value for the channel with the input range of 0 to 5V

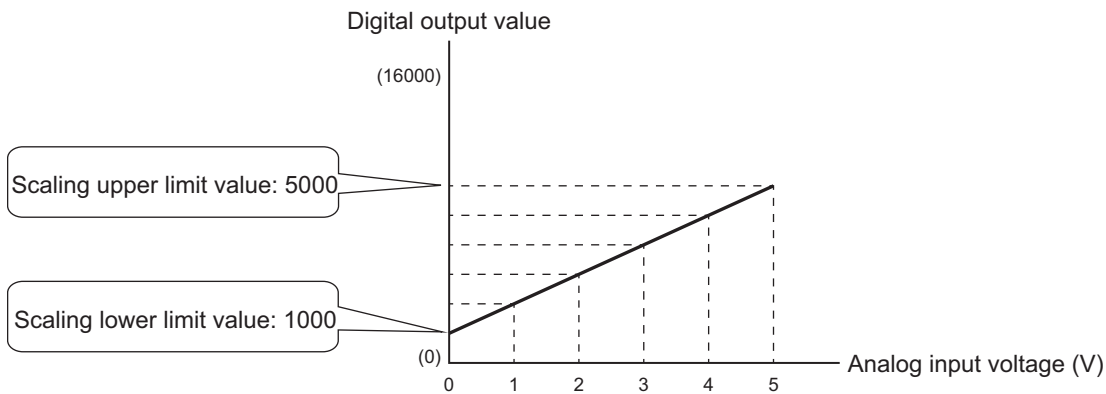

Voltage input (V)	Digital output value	Digital operation value (scaling value)
0	0	1000
1	3200	1800
2	6400	2600
3	9600	3400
4	12800	4200
5	16000	5000

**Ex.**

When 1000 is set to the scaling upper limit value and 5000 is set to the scaling lower limit value for the channel with the input range of 0 to 5V

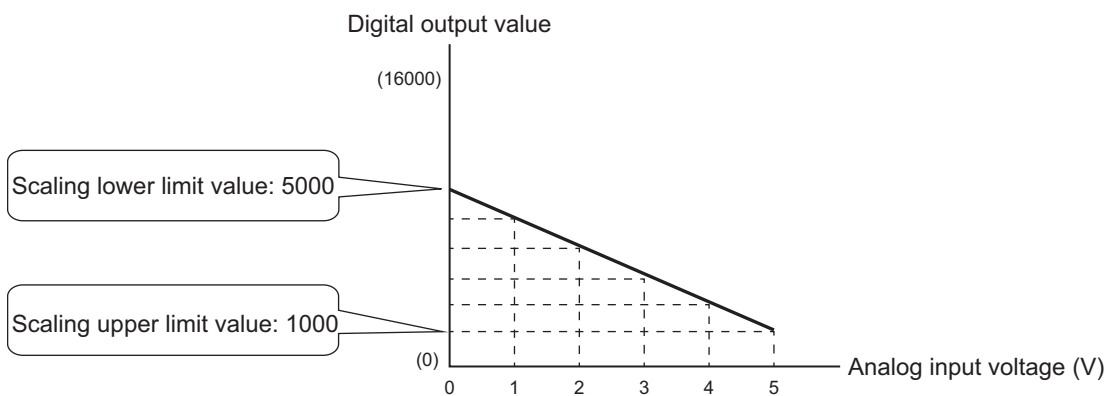

Voltage input (V)	Digital output value	Digital operation value (scaling value)
0	0	5000
1	3200	4200
2	6400	3400
3	9600	2600
4	12800	1800
5	16000	1000

Ex.

When 2500 is set to the scaling upper limit value and 500 is set to the scaling lower limit value for the channel with the input range of -10 to +10V

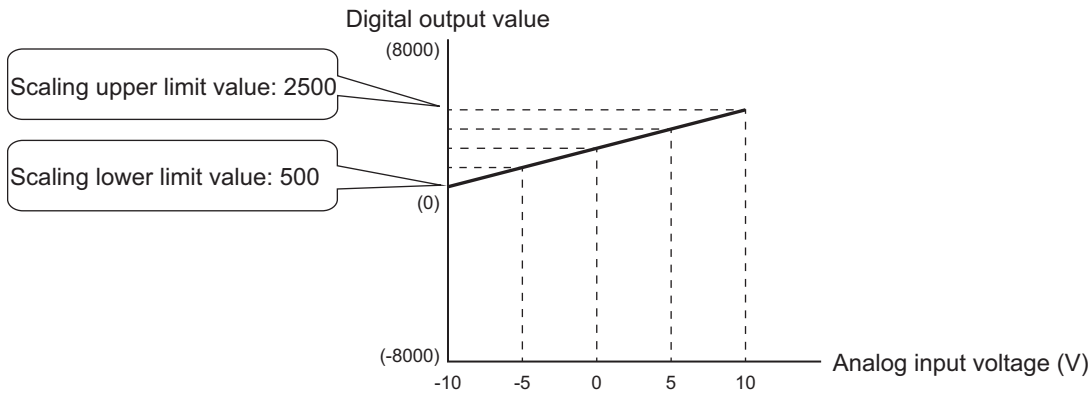

Voltage input (V)	Digital output value	Digital operation value (scaling value)
-10	-8000	500
-5	-4000	1000
0	0	1500
5	4000	2000
10	8000	2500

Ex.

When 500 is set to the scaling upper limit value and 2500 is set to the scaling lower limit value for the channel with the input range of -10 to +10V

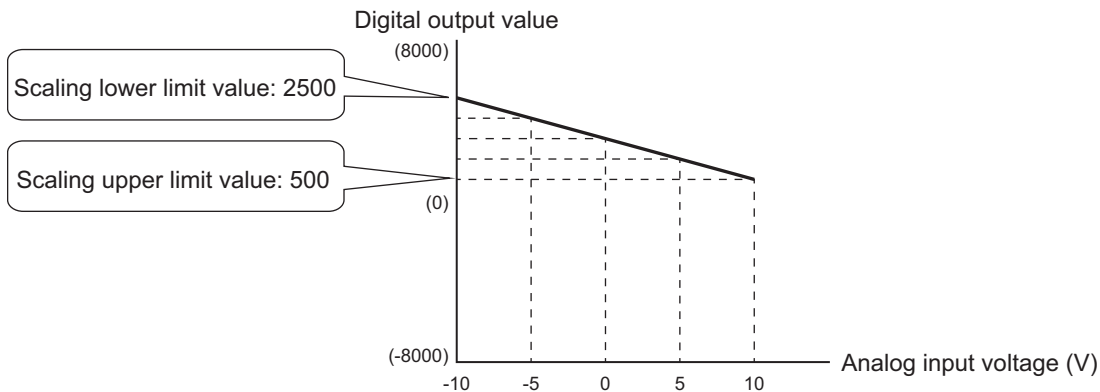

Voltage input (V)	Digital output value	Digital operation value (scaling value)
-10	-8000	2500
-5	-4000	2000
0	0	1500
5	4000	1000
10	8000	500

Point

When the scaling function is used with the digital clipping function, the scale conversion is performed on the digital operation values after digital clipping.

# Warning output function

FX5-4A-ADP

FX5-4AD-ADP

FX5-4DA-ADP

FX5-4AD-PT-ADP

FX5-4AD-TC-ADP

This section describes process alarms and rate alarms used for the warning output function.

## Process alarm

This function outputs an alarm when a digital operation value enters the preset warning output range.

Digital operation value

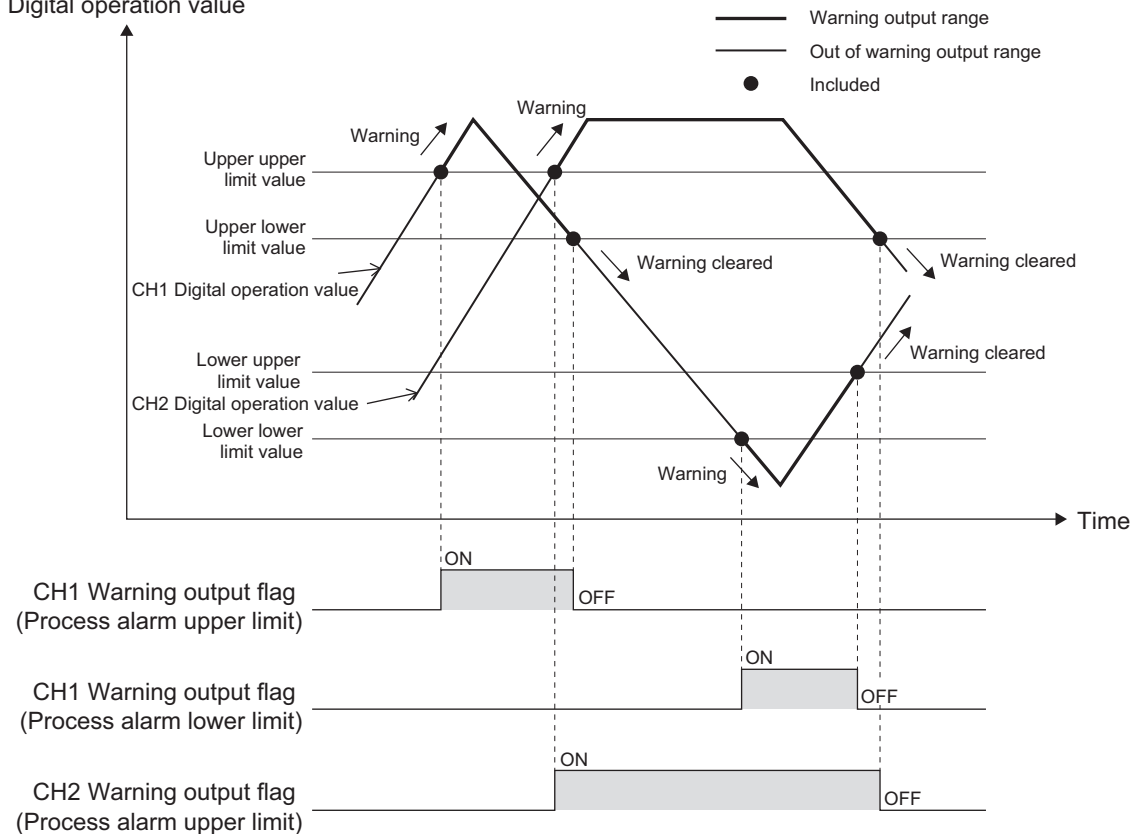

### ■Operation

When the digital operation value is above the process alarm upper upper limit value or below the process alarm lower lower limit value and the warning output condition is satisfied, the "warning output flag (process alarm upper limit)" or "warning output flag (process alarm lower limit)" turns ON.

When the digital operation value changes to a value below the process alarm upper lower limit value or above the process alarm lower upper limit value and the warning output condition is not satisfied after the warning output, the "warning output flag (process alarm upper limit)" or "warning output flag (process alarm lower limit)" turns OFF. The "warning output flag" (process alarm upper limit)" and "warning output flag (process alarm lower limit)" also turn OFF when the "warning output setting" is changed to "disable". However, the alarm code stored in the "A/D conversion latest alarm code" is not cleared. For clearing the alarm code stored in the "A/D conversion latest alarm code", wait until the "warning output flag (process alarm upper limit)" and "warning output flag (process alarm lower limit)" turn OFF, and then set the "A/D conversion alarm clear request" ("Alarm clear request" for the FX5-4AD-ADP) to OFF, ON, and OFF.

### ■Detection cycle

When time average is specified, the function works at every interval of the time (for averaging). When count average is specified, the function works at every count (for averaging).

When the sampling processing and moving average is specified, this function works at every sampling cycle.

## ■Detection target for outputting a warning

When using the digital clipping function, scaling function, and shift function, the digital operation value resulting from digital clipping, scale conversion, and shift additions becomes the detection target for outputting a warning. Always set the process alarm upper upper limit value, process alarm upper lower limit value, process alarm lower upper limit value, and process alarm lower lower limit value to values that take digital clipping, scale conversion, and shift addition into consideration.

## ■Setting procedure

1. Set "Warning output setting (Process alarm)" to "Enable".

 Navigation window ⇒ [Parameter] ⇒ [Module Information] ⇒ Module model name ⇒ [Module Parameter] ⇒ "Application Settings" ⇒ "Warning output function (Process alarm)"

2. Set values for "Process Alarm Upper Upper Limit Value", "Process Alarm Upper Lower Limit Value", "Process Alarm Lower Upper Limit Value", and "Process Alarm Lower Lower Limit Value".

Item	Setting range
Process alarm upper upper limit value	-32768 to +32767
Process alarm upper lower limit value	
Process alarm lower upper limit value	
Process alarm lower lower limit value	

### Point

Set values within the range satisfying the condition "Process alarm upper upper limit value  $\geq$  Process alarm upper lower limit value  $\geq$  Process alarm lower upper limit value  $\geq$  Process alarm lower lower limit value".  
When not satisfying the above conditions, a process alarm upper lower limit value setting range error occurs.  
(Error code: 1A4□H)

## ■Corresponding devices

The devices which are used by the process alarm are listed below.

Name	Connection part	Special relay			
		CH1	CH2	CH3*1	CH4*1
Warning output flag (process alarm upper limit)	1st adapter	SM6311	SM6351	SM6391	SM6431
	2nd adapter	SM6671	SM6711	SM6751	SM6791
	3rd adapter	SM7031	SM7071	SM7111	SM7151
	4th adapter	SM7391	SM7431	SM7471	SM7511
Warning output flag (process alarm lower limit)	1st adapter	SM6312	SM6352	SM6392	SM6432
	2nd adapter	SM6672	SM6712	SM6752	SM6792
	3rd adapter	SM7032	SM7072	SM7112	SM7152
	4th adapter	SM7392	SM7432	SM7472	SM7512
Warning output setting (process alarm)	1st adapter	SM6313	SM6353	SM6393	SM6433
	2nd adapter	SM6673	SM6713	SM6753	SM6793
	3rd adapter	SM7033	SM7073	SM7113	SM7153
	4th adapter	SM7393	SM7433	SM7473	SM7513
Process alarm upper upper limit value	1st adapter	SD6311	SD6351	SD6391	SD6431
	2nd adapter	SD6671	SD6711	SD6751	SD6791
	3rd adapter	SD7031	SD7071	SD7111	SD7151
	4th adapter	SD7391	SD7431	SD7471	SD7511
Process alarm upper lower limit value	1st adapter	SD6312	SD6352	SD6392	SD6432
	2nd adapter	SD6672	SD6712	SD6752	SD6792
	3rd adapter	SD7032	SD7072	SD7112	SD7152
	4th adapter	SD7392	SD7432	SD7472	SD7512
Process alarm lower upper limit value	1st adapter	SD6313	SD6353	SD6393	SD6433
	2nd adapter	SD6673	SD6713	SD6753	SD6793
	3rd adapter	SD7033	SD7073	SD7113	SD7153
	4th adapter	SD7393	SD7433	SD7473	SD7513
Process alarm lower lower limit value	1st adapter	SD6314	SD6354	SD6394	SD6434
	2nd adapter	SD6674	SD6714	SD6754	SD6794
	3rd adapter	SD7034	SD7074	SD7114	SD7154
	4th adapter	SD7394	SD7434	SD7474	SD7514

\*1 Only used by the FX5-4AD-ADP.

The details of the device used are listed below.

Name	Description	Monitor value	Display description	Default value	R/W
Warning output flag (process alarm upper limit) Warning output flag (process alarm lower limit)	Monitors the upper limit value warning and lower limit value warning in the process alarm.	0: OFF	Normal	0: OFF	R
		1: ON	Process alarm upper/lower limit detection		
Warning output setting (process alarm)	Set whether to enable or disable the warning output of process alarm.	0: OFF	Warning output of process alarm enable	1: ON	R/W
		1: ON	Warning output of process alarm disable		

Name	Description	Range	Default value	R/W
Process alarm upper upper limit value Process Alarm Upper Lower Limit Value Process alarm lower upper limit value Process alarm lower lower limit value	Set the upper upper limit value, upper lower limit value, lower upper limit value, and lower lower limit value for the warning output function (process alarm).  The process alarm upper lower limit value setting range error occurs when the condition "Process alarm upper upper limit value $\geq$ Process alarm upper lower limit value $\geq$ Process alarm lower upper limit value $\geq$ Process alarm lower lower limit value" is not satisfied. (Error code: 1A4□H)	-32768 to +32767	0	R/W

## Rate alarm

This function outputs a warning when the change rate of a digital output value is equal to or greater than the rate alarm upper limit value, or equal to or smaller than the rate alarm lower limit value.

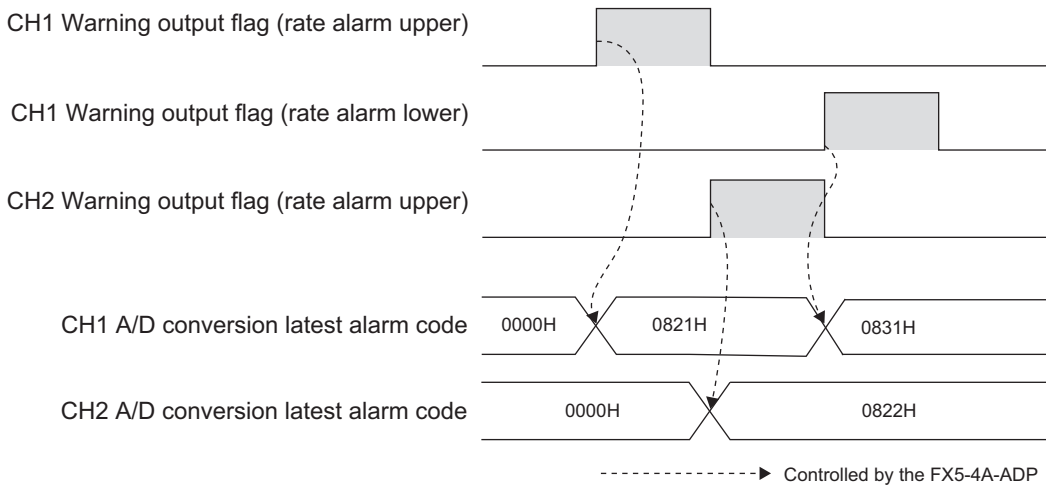
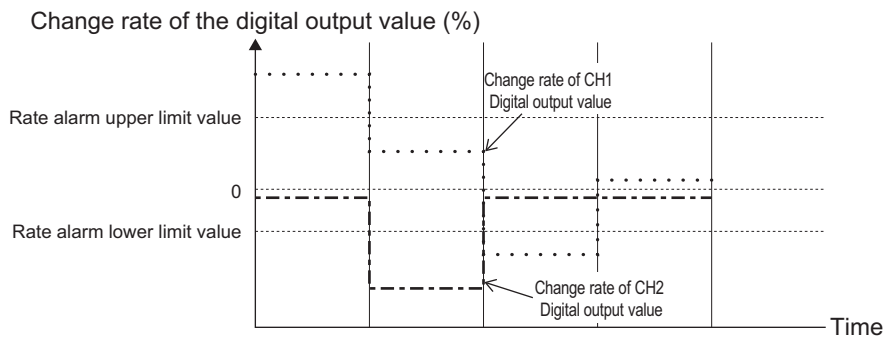
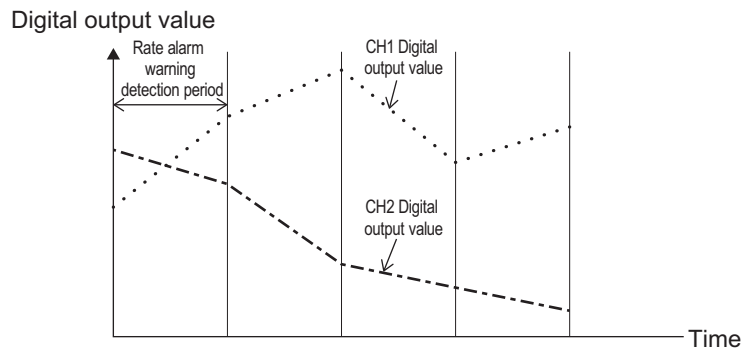

## ■Operation

The digital output value is monitored every rate alarm warning detection period. When the change from the previous value shows a rate of change that is greater than or equal to the rate alarm upper limit value or less than or equal to the rate alarm lower limit value, the "Warning output flag (rate alarm upper limit)" or the "Warning output flag (rate alarm lower limit)" turns ON.

When the digital output value changes to a value below the rate alarm upper limit value or above the rate alarm upper limit value and the warning output condition is not satisfied after the warning output, the "warning output flag (rate alarm upper limit)" or "warning output flag (rate alarm lower limit)" turns OFF. The "warning output flag (rate alarm upper limit)" and "warning output flag (rate alarm lower limit)" turn OFF also when the "warning output setting (rate alarm)" is set to "disable". However, the alarm code stored in the "A/D conversion latest alarm code" is not cleared.

For clearing the alarm code stored in the "A/D conversion latest alarm code", wait until the "warning output flag (rate alarm upper limit)" and "warning output flag (rate alarm lower limit)" turn OFF, and then set the "A/D conversion alarm clear request" ("Alarm clear request" for the FX5-4AD-ADP) to OFF, ON, and OFF.

## ■Detection cycle

Set the rate alarm warning detection period in "rate alarm warning detection period setting".

## ■Judgment of rate alarm

A change rate is judged with "Rate alarm upper limit value" and "Rate alarm lower limit value" converted to digital values per "rate alarm warning detection period".

The following shows the conversion formula of judgment values used for the rate alarm detection.

Value used for judgment in every rate alarm warning detection period (digit)<sup>\*1</sup>

= (Rate alarm upper limit value (lower limit value)) × 0.1 × 0.01 × Maximum digital output value

**Ex.**

The judgment value under the following conditions

Setting item	Description
Averaging process specify	Sampling processing
Rate alarm warning detection period setting	10 (ms)
Rate alarm upper limit value	250 (25.0%)
Rate alarm lower limit value	50 (5.0%)

Upper limit value:  $250 \times 0.1 \times 0.01 \times 16000 = 4000$  (digit)

Lower limit value:  $50 \times 0.1 \times 0.01 \times 16000 = 800$  (digit)

The current value is compared with the previous value in every rate alarm warning detection period ("10 ms" in this example). It is checked whether the current digital value is larger by more than 4000 digits (25.0%) or smaller by more than 800 digits (5.0%) compared to the previous value.

The following formula is used to obtain the change rate to be set based on the change amount of the voltage/current to detect warning:

$$\text{Change rate to be set (0.1 \%)} = \left( \frac{\text{Change amount of the voltage (current) to detect warning (V (mA))}}{\text{Gain voltage (current) (V(mA)) - Offset voltage (current) (V (mA))}} \times 1000 \right)^{*1}$$

\*1 The value below the decimal point obtained by calculation is rounded.



### ■Application examples of rate alarms

A rate alarm serves to monitor that the change rate of a digital output value lies in a limited range as shown below.

**Ex.**

To monitor that a rising rate of a digital output value is within the specified range

Change rate of the digital output value (%)

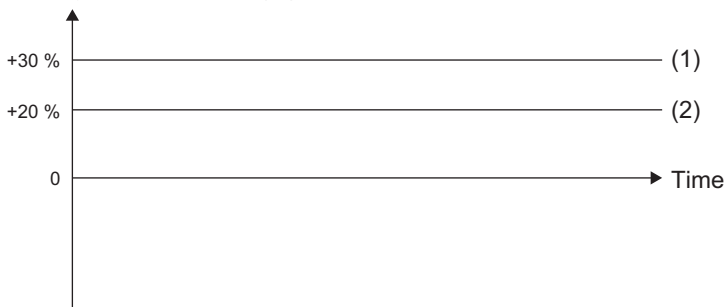

(1) Rate alarm upper limit value  
(2) Rate alarm lower limit value

**Ex.**

To monitor that a drop rate of a digital output value is within the specified range

Change rate of the digital output value (%)

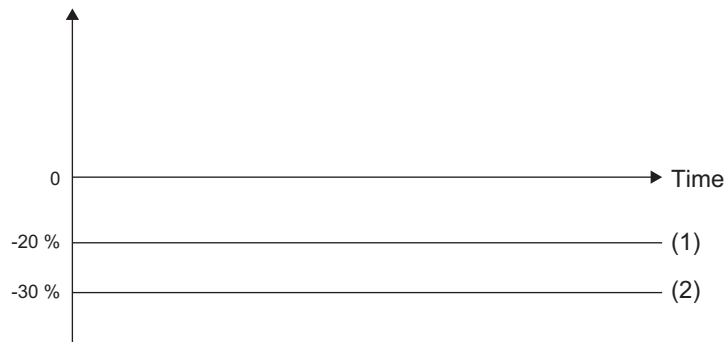

(1) Rate alarm upper limit value  
(2) Rate alarm lower limit value

**Ex.**

To monitor that a change rate of a digital output value is within the specified range

Change rate of the digital output value (%)

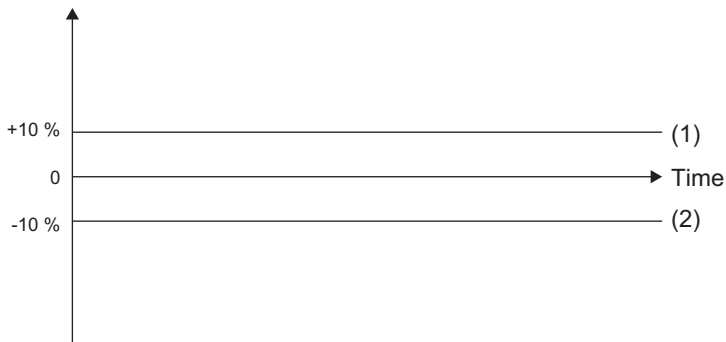

(1) Rate alarm upper limit value  
(2) Rate alarm lower limit value

### ■Setting procedure

1. Set "Warning output function (Rate alarm)" to "Enable".

Navigation window ⇒ [Parameter] ⇒ [Module Information] ⇒ Module model name ⇒ [Module Parameter] ⇒ "Application Settings" ⇒ "Warning output function (Rate alarm)"

## 2. Set a warning detection period of rate alarms.

Set the cycle in "Rate alarm warning detection period setting".

Item	Setting range
Rate alarm warning detection period setting	1 to 10000 (ms)

### Point

When a value outside the setting range is set, the rate alarm warning detection period setting range error occurs. (Error code: 1A6□H)

## 3. Set values for "Rate alarm upper limit value" and "Rate alarm lower limit value".

Set a value for the maximum value (16000) of the digital output value in increments of 0.1%.

Item	Setting range
Rate alarm upper limit value	-1000 to +1000 (0.1%)
Rate alarm lower limit value	

### Point

Set values within the range satisfying the condition "Rate alarm upper limit value > Rate alarm lower limit value".

When not satisfying the above conditions, a rate alarm upper/lower limit setting value inversion error occurs. (Error code: 1A5□H)

## ■Corresponding devices

The devices used by the rate alarm are listed below.

Name	Connection part	Special relay			
		CH1	CH2	CH3*1	CH4*1
Warning output flag (rate alarm upper limit)	1st adapter	SM6315	SM6355	SM6395	SM6435
	2nd adapter	SM6675	SM6715	SM6755	SM6795
	3rd adapter	SM7035	SM7075	SM7115	SM7155
	4th adapter	SM7395	SM7435	SM7475	SM7515
Warning output flag (rate alarm lower)	1st adapter	SM6316	SM6356	SM6396	SM6436
	2nd adapter	SM6676	SM6716	SM6756	SM6796
	3rd adapter	SM7036	SM7076	SM7116	SM7156
	4th adapter	SM7396	SM7436	SM7476	SM7516
Warning output setting (rate alarm)	1st adapter	SM6317	SM6357	SM6397	SM6437
	2nd adapter	SM6677	SM6717	SM6757	SM6797
	3rd adapter	SM7037	SM7077	SM7117	SM7157
	4th adapter	SM7397	SM7437	SM7477	SM7517
Rate alarm upper limit value	1st adapter	SD6315	SD6355	SD6395	SD6435
	2nd adapter	SD6675	SD6715	SD6755	SD6795
	3rd adapter	SD7035	SD7075	SD7115	SD7155
	4th adapter	SD7395	SD7435	SD7475	SD7515
Rate alarm lower limit value	1st adapter	SD6316	SD6356	SD6396	SD6436
	2nd adapter	SD6676	SD6716	SD6756	SD6796
	3rd adapter	SD7036	SD7076	SD7116	SD7156
	4th adapter	SD7396	SD7436	SD7476	SD7516
Rate alarm warning detection period setting	1st adapter	SD6317	SD6357	SD6397	SD6437
	2nd adapter	SD6677	SD6717	SD6757	SD6797
	3rd adapter	SD7037	SD7077	SD7117	SD7157
	4th adapter	SD7397	SD7437	SD7477	SD7517

\*1 Only used by the FX5-4AD-ADP.

The details of the device used are listed below.

Name	Description	Monitor value	Display description	Default value	R/W
Warning output flag (rate alarm upper limit) Warning output flag (rate alarm lower)	Monitors the upper limit value warning and lower limit value warning in the rate alarm.	0: OFF	Normal	0: OFF	R
		1: ON	Rate alarm upper/lower limit detection		
Warning output setting (rate alarm)	Set whether to enable or disable the warning output of rate alarm.	0: OFF	Warning output of rate alarm enable	1: ON	R/W
		1: ON	Warning output of rate alarm disable		

Name	Description	Range	Default value	R/W
Rate alarm upper limit value Rate alarm lower limit value	Set the upper limit of the rate of change of the digital output value for detecting rate alarms. Set the rate alarm upper limit value in the unit "0.1 %". If the condition "rate alarm upper limit value > rate alarm lower limit value" is not satisfied, the rate alarm upper limit value/lower limit value setting inversion error (Error code: 1A5□H) occurs.	-1000 to +1000	0	R/W
Rate alarm warning detection period setting	Set the cycle for checking the rate of change of the digital output value. The "rate alarm warning detection period setting" multiplied by the sampling cycle indicates the cycle for detecting rate alarms. If a value other than the setting value is set, the rate alarm warning detection period setting range error (Error code: 1A6□H) occurs.	1 to 10000 (ms)	1	R/W

## Shift function



This function adds (shifts) the set conversion value shift amount to the digital operation value and stores it in "Digital operation value". When the conversion value shift amount is changed, the change will be reflected in the digital operation value in real time, allowing fine adjustments to be easily performed during system startup.

### Operation

The set "Shifting amount to conversion value" is added to the digital operation value. The added digital operation value is stored in "Digital operation value".

When sampling processing is performed, the converted value shift amount is added for each scan. When averaging processing is performed, the converted value shift amount is added for each averaging processing cycle. The results are stored in the "Digital operation value".

When the digital operation value resulting from the shift processing exceeds the range of -32768 to +32767, the value is fixed to the lower limit (-32768) or the upper limit (+32767).

#### Point

- When the scaling function is used together, the shift processing is executed to the value after scale conversion.
- When the digital clipping function and the scaling function are used together, shift processing is performed on the value after digital clipping and scaling.

### Setting procedure

Set a value for "Shifting amount to conversion value".

Navigation window ⇒ [Parameter] ⇒ [Module Information] ⇒ Module model name ⇒ [Module Parameter] ⇒ "Application Settings" ⇒ "Shift Function"

Item	Setting range
Conversion value shift amount	-32768 to +32767

## Corresponding devices

The devices which are used by the shift function are listed below.

Name	Connection part	Special register			
		CH1	CH2	CH3 <sup>*1</sup>	CH4 <sup>*1</sup>
Conversion value shift amount	1st adapter	SD6310	SD6350	SD6390	SD6430
	2nd adapter	SD6670	SD6710	SD6750	SD6790
	3rd adapter	SD7030	SD7070	SD7110	SD7150
	4th adapter	SD7390	SD7430	SD7470	SD7510

\*1 Only used by the FX5-4AD-ADP.

The details of the device used are listed below.

Name	Description	Range	Default value	R/W
Conversion value shift amount	Set the "conversion value shift amount" used in the shift function. The set value is added to the "Digital operation value".	-32768 to +32767	0	R/W

## Setting example

**Ex.**

When the input characteristics are adjusted in a channel where the input range of 0 to 10V is set by the shift function

Digital output value

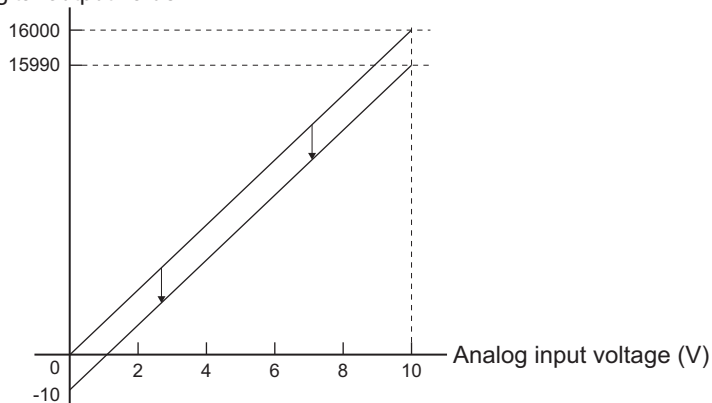

Voltage input (V)	Digital output value	Digital operation value
0	0	-10
10	16000	15990

# Convergence detection function

FX5-4A-ADP
FX5-4AD-ADP
FX5-4DA-ADP
FX5-4AD-PT-ADP
FX5-4AD-TC-ADP

This function detects whether the digital operation value is within a certain range for a specified time.

## Operation

Time is measured when the digital operation value falls within the convergence range.

If the digital operation value falls within the convergence range within the time set in the "Detection time setting for convergence detection", the "convergence detection flag" turns ON. When the digital operation value goes outside the convergence range, the "convergence detection flag" turns OFF. The "convergence detection flag" turns OFF also when the "convergence detection enable/disable setting" is changed to "disable".

The digital operation value is always monitored until the "convergence detection enable/disable setting" is set to "disable".

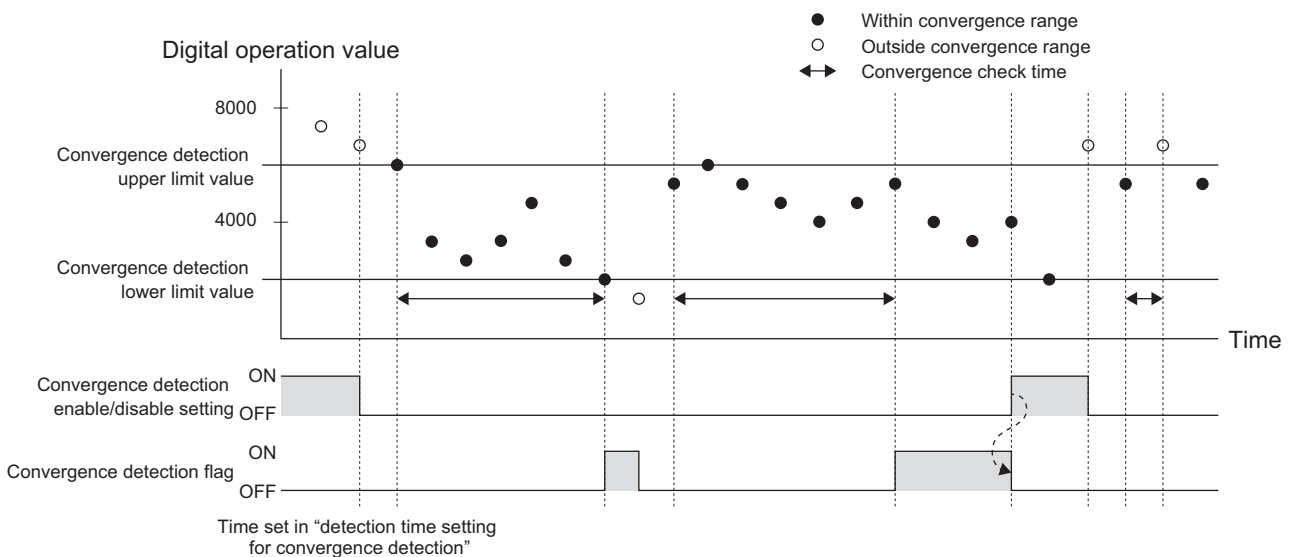

## Convergence detection condition

The table below shows the convergence detection condition when the "convergence detection enable/disable setting" is set to "enable".

Within convergence range	Outside convergence range
Not less than convergence detection lower limit value and not more than convergence detection upper limit value	Less than convergence detection lower limit value or more than convergence detection upper limit value

## Setting procedure

**1.** Set "Convergence detection enable/disable setting" to "Enable".

Navigation window ⇒ [Parameter] ⇒ [Module Information] ⇒ Module model name ⇒ [Module Parameter] ⇒ "Application Settings" ⇒ "Convergence detection enable/disable setting"

**2.** Set values for "Detection time setting for convergence detection".

Item	Setting range
Detection time setting for convergence detection	1 to 10000 (ms)

**Point**

When a value outside the setting range is set, the convergence detection time setting range error occurs. (Error code: 1AC□H)

### 3. Set values for "Convergence detection upper limit value" and "Convergence detection lower limit value".

Item	Setting range
Convergence detection upper limit value	-32768 to +32767
Convergence detection lower limit value	

#### Point

Set values so that the condition "Convergence detection upper limit value > Convergence detection lower limit value" is satisfied.

When not satisfying the above conditions, a convergence detection upper limit value/lower limit value setting inversion error occurs. (Error code: 1AD□H)

## Corresponding devices

The devices which are used by the convergence detection function are listed below.

Name	Connection part	Special relay			
		CH1	CH2	CH3 <sup>*1</sup>	CH4 <sup>*1</sup>
Convergence detection flag	1st adapter	SM6321	SM6361	SM6401	SM6441
	2nd adapter	SM6681	SM6721	SM6761	SM6801
	3rd adapter	SM7041	SM7081	SM7121	SM7161
	4th adapter	SM7401	SM7441	SM7481	SM7521
Convergence detection enable/disable setting	1st adapter	SM6322	SM6362	SM6402	SM6442
	2nd adapter	SM6682	SM6722	SM6762	SM6802
	3rd adapter	SM7042	SM7082	SM7122	SM7162
	4th adapter	SM7402	SM7442	SM7482	SM7522
Convergence detection upper limit value	1st adapter	SD6322	SD6362	SD6402	SD6442
	2nd adapter	SD6682	SD6722	SD6762	SD6802
	3rd adapter	SD7042	SD7082	SD7122	SD7162
	4th adapter	SD7402	SD7442	SD7482	SD7522
Convergence detection lower limit value	1st adapter	SD6323	SD6363	SD6403	SD6443
	2nd adapter	SD6683	SD6723	SD6763	SD6803
	3rd adapter	SD7043	SD7083	SD7123	SD7163
	4th adapter	SD7403	SD7443	SD7483	SD7523
Detection time setting for convergence detection	1st adapter	SD6324	SD6364	SD6404	SD6444
	2nd adapter	SD6684	SD6724	SD6764	SD6804
	3rd adapter	SD7044	SD7084	SD7124	SD7164
	4th adapter	SD7404	SD7444	SD7484	SD7524

\*1 Only used by the FX5-4AD-ADP.

The details of the device used are listed below.

Name	Description	Monitor value	Display description	Default value	R/W
Convergence detection flag	This flag monitors the convergence detection.	0: OFF	Normal	0: OFF	R
		1: ON	Convergence detection		
Convergence detection enable/disable setting	Set whether to enable or disable the convergence detection.	0: OFF	Convergence detection enable	1: ON	R/W
		1: ON	Convergence detection disable		

Name	Description	Range	Default value	R/W
Convergence detection upper limit value	Set the upper and lower limits of the digital output value used in the convergence detection function.	-32768 to +32767	0	R/W
Convergence detection lower limit value	If the condition "Convergence detection upper limit value > Convergence detection lower limit value" is not satisfied, the convergence detection upper limit value/lower limit value setting inversion error (Error code: 1AD□H) occurs.			
Detection time setting for convergence detection	Set the convergence detection time used in the convergence detection function. If a value outside the range is set, the convergence detection time setting range error (Error code: 1AC□H) occurs. The setting value will be ignored when the convergence detection enable/disable setting is set to "disable".	1 to 10000 (ms)	1	R/W

# Maximum value/minimum value hold function

FX5-4A-ADP

FX5-4AD-ADP

FX5-4DA-ADP

FX5-4AD-PT-ADP

FX5-4AD-TC-ADP

This function stores the maximum value and minimum value of the digital operation value to the special registers for each channel.

This function can be set only with special devices.

## Operation

When the "Maximum value reset request" or "Minimum value reset request" is set from OFF to ON, the maximum value or minimum value of the channel is updated to "Digital operation value". The "maximum value/minimum value reset completion flag" turns ON.

If the range is switched, the "maximum value" and "minimum value" are cleared (0).

## Setting procedure

When the "Maximum value reset request" or "Minimum value reset request" is set from OFF to ON, the maximum value or minimum value is updated to the digital operation value.

Setting value	Description	Default value
0: OFF	With no maximum value or minimum value reset request	0: OFF
1: ON	With maximum value or minimum value reset request	

## Corresponding devices

The devices which are used by the function to hold minimum and maximum values are listed below.

Name	Connection part	Special relay			
		CH1	CH2	CH3 <sup>*1</sup>	CH4 <sup>*1</sup>
Maximum value/minimum value reset completed flag	1st adapter	SM6305	SM6345	SM6385	SM6425
	2nd adapter	SM6665	SM6705	SM6745	SM6785
	3rd adapter	SM7025	SM7065	SM7105	SM7145
	4th adapter	SM7385	SM7425	SM7465	SM7505
Maximum value reset request	1st adapter	SM6306	SM6346	SM6386	SM6426
	2nd adapter	SM6666	SM6706	SM6746	SM6786
	3rd adapter	SM7026	SM7066	SM7106	SM7146
	4th adapter	SM7386	SM7426	SM7466	SM7506
Minimum value reset request	1st adapter	SM6307	SM6347	SM6387	SM6427
	2nd adapter	SM6667	SM6707	SM6747	SM6787
	3rd adapter	SM7027	SM7067	SM7107	SM7147
	4th adapter	SM7387	SM7427	SM7467	SM7507
Maximum value	1st adapter	SD6306	SD6346	SD6386	SD6426
	2nd adapter	SD6666	SD6706	SD6746	SD6786
	3rd adapter	SD7026	SD7066	SD7106	SD7146
	4th adapter	SD7386	SD7426	SD7466	SD7506
Minimum value	1st adapter	SD6307	SD6347	SD6387	SD6427
	2nd adapter	SD6667	SD6707	SD6747	SD6787
	3rd adapter	SD7027	SD7067	SD7107	SD7147
	4th adapter	SD7387	SD7427	SD7467	SD7507

\*1 Only used by the FX5-4AD-ADP.

The details of the device used are listed below.

Name	Description	Monitor value	Display description	Default value	R/W
Maximum value/ minimum value reset completed flag	This flag monitors the "maximum value/minimum value" reset status. When the "maximum value reset request" or "minimum value reset request" is set from OFF to ON and then the value stored in the "maximum value" or "minimum value" is reset, the "maximum value/minimum value reset completion flag" turns ON.	0: OFF	Reset is not completed.	0: OFF	R
		1: ON	Reset is completed.		

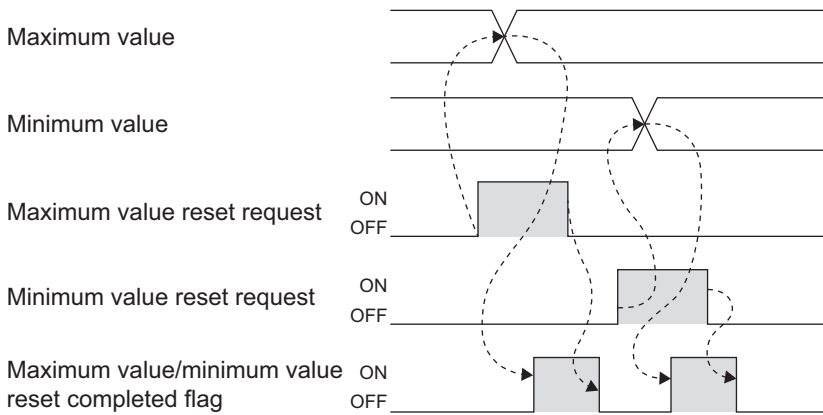

Name	Description	Setting value	Description	Default value	R/W
Maximum value reset request Minimum value reset request	When "Maximum value/Minimum value reset request" is set from OFF to ON, the maximum value and minimum value are updated to "Digital operation value".	0: OFF	With no maximum value and minimum value reset request	0: OFF	R/W
		1: ON	With maximum value and minimum value reset request		

Name	Description	Range	Default value	R/W
Maximum value Minimum value	The maximum and minimum values of the digital operation values are stored. When "Maximum value/Minimum value reset request" is set from OFF to ON, the maximum and minimum values of the channel are updated to "Digital operation value".	-32768 to +32767	0	R

## Deviation detection between channel function



This function detects whether there is a difference of more than a certain level in digital operation values between channels.

### Operation

"Digital operation value" of the channel is compared with "Digital operation value" of the channel set for "CH setting for deviation detection between channel".

If the difference between the digital operation value of the channel and the digital operation value of the comparison target channel is equal to or greater than the "Deviation value for deviation detection between channels" for even one channel, the deviation is detected and the "Deviation detection flag between channel" turns ON. (Alarm code: 0B0□H)

If the difference between the digital operation value of the channel and the digital operation value of the comparison target channel is less than the "Deviation value for deviation detection between channels" for all channels, "Deviation detection flag between channel" turns OFF.

If "Deviation detection trigger between channels" is disabled, the "Deviation detection flag between channel" turns OFF, and "Deviation detection CH1" and "Deviation detection CH2" become 0 (initial value).



### ■ Deviation detection CH1

Check the status of the deviation between CH detection flag in the 1st and 2nd FX5-4A-ADP, or FX5-4AD-ADP used in the deviation between CH detection function.

Monitor value	Display description	Default value	R/W
0: OFF	Normal	0: OFF	R
1: ON	Deviation detection		

■ When the deviation detection target is FX5-4A-ADP

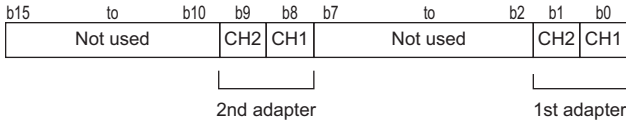

■ When the deviation detection target is FX5-4AD-ADP

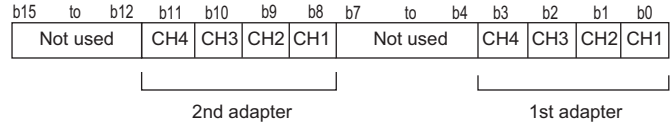

### ■ Deviation detection CH2

Check the status of the deviation between CH detection flag in the 3rd and 4th FX5-4A-ADP, or FX5-4AD-ADP used in the deviation between CH detection function.

Only used by the FX5S/FX5U/FX5UC CPU module.

Monitor value	Display description	Default value	R/W
0: OFF	Normal	0: OFF	R
1: ON	Deviation detection		

■ When the deviation detection target is FX5-4A-ADP

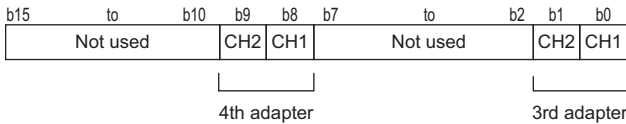

■ When the deviation detection target is FX5-4AD-ADP

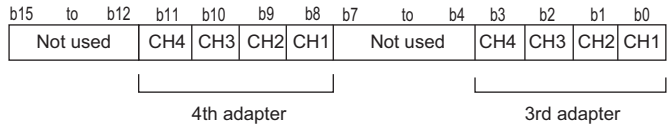

### ■ CH setting 1 for deviation detection between channel

Set the channels whose deviation will be checked in the 1st and 2nd FX5-4A-ADP, or FX5-4AD-ADP used in the deviation detection between channel function.

Monitor value	Display description	Default value	R/W
0: OFF	Non target	0	R/W
1: ON	Target		

■ When the deviation detection target is FX5-4A-ADP

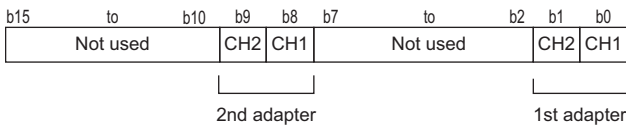

■ When the deviation detection target is FX5-4AD-ADP

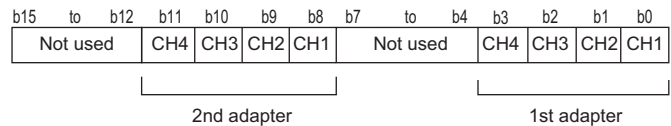

### ■ CH setting 2 for deviation detection between channel

Set the channels whose deviation will be checked in the 3rd and 4th FX5-4A-ADP, or FX5-4AD-ADP used in the deviation detection between channel function.

Only used by the FX5S/FX5U/FX5UC CPU module.

Setting value	Display description	Default value	R/W
0: OFF	Non target	0	R/W
1: ON	Target		

■ When the deviation detection target is FX5-4A-ADP

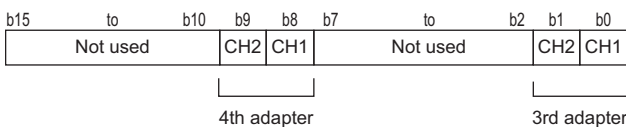

■ When the deviation detection target is FX5-4AD-ADP

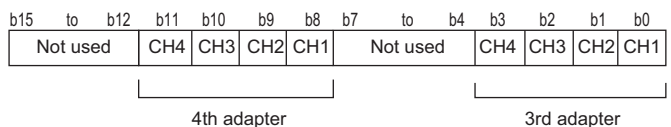

## Setting procedure

1. Set "Deviation detection trigger between channel" to "Enable".

Navigation window ⇒ [Parameter] ⇒ [Module Information] ⇒ Module model name ⇒ [Module Parameter] ⇒ "Application Settings" ⇒ "Deviation detection trigger between channel"

2. Set values for "Deviation value for deviation detection between channel".

Item	Setting range
Deviation value for deviation detection between channel	0 to 65535

3. Set whether to perform the deviation check for each channel with "CH setting for deviation detection between channel".

Item	Setting range
CH setting for deviation detection between channel	Non-target
	Target

## Corresponding devices

The devices which are used by the deviation detection between channel function are listed below.

Name	Connection part	Special relay			
		CH1	CH2	CH3 <sup>*2</sup>	CH4 <sup>*2</sup>
Deviation detection flag between channel	1st adapter	SM6325	SM6365	SM6405	SM6445
	2nd adapter	SM6685	SM6725	SM6765	SM6805
	3rd adapter	SM7045	SM7085	SM7125	SM7165
	4th adapter	SM7405	SM7445	SM7485	SM7525
Deviation detection trigger between channel	1st adapter	SM6326	SM6366	SM6406	SM6446
	2nd adapter	SM6686	SM6726	SM6766	SM6806
	3rd adapter	SM7046	SM7086	SM7126	SM7166
	4th adapter	SM7406	SM7446	SM7486	SM7526
Deviation detection CH1 <sup>*1</sup>	1st adapter	SD6325	SD6365	SD6405	SD6445
	2nd adapter	SD6685	SD6725	SD6765	SD6805
	3rd adapter	SD7045	SD7085	SD7125	SD7165
	4th adapter	SD7405	SD7445	SD7485	SD7525
Deviation detection CH2	1st adapter	SD6326	SD6366	SD6406	SD6446
	2nd adapter	SD6686	SD6726	SD6766	SD6806
	3rd adapter	SD7046	SD7086	SD7126	SD7166
	4th adapter	SD7406	SD7446	SD7486	SD7526
Deviation value for deviation detection between channel	1st adapter	SD6327	SD6367	SD6407	SD6447
	2nd adapter	SD6687	SD6727	SD6767	SD6807
	3rd adapter	SD7047	SD7087	SD7127	SD7167
	4th adapter	SD7407	SD7447	SD7487	SD7527
CH setting 1 for deviation detection between channel <sup>*1</sup>	1st adapter	SD6328	SD6368	SD6408	SD6448
	2nd adapter	SD6688	SD6728	SD6768	SD6808
	3rd adapter	SD7048	SD7088	SD7128	SD7168
	4th adapter	SD7408	SD7448	SD7488	SD7528
CH setting 2 for deviation detection between channel <sup>*1</sup>	1st adapter	SD6329	SD6369	SD6409	SD6449
	2nd adapter	SD6689	SD6729	SD6769	SD6809
	3rd adapter	SD7049	SD7089	SD7129	SD7169
	4th adapter	SD7409	SD7449	SD7489	SD7529

\*1 Only used by the FX5S/FX5U/FX5UC CPU module.

\*2 Only used by the FX5-4AD-ADP.

The details of the device used are listed below.

Name		Setting value	Description	Default value	R/W
Deviation detection flag between channel	This flag monitors the deviation detection between channels.	0: OFF	Normal	0: OFF	R
		1: ON	Deviation detection		
Deviation detection trigger between channels	Set whether to enable or disable the deviation detection between channels.	0: OFF	Deviation detection enable	1: ON	R/W
		1: ON	Deviation detection disable		

Name	Description	Range	Default value	R/W
Deviation value for deviation detection between channels	Set the deviation value between channels used in the deviation detection between channel function.	0 to 65535	0	R/W
Deviation detection CH1 Deviation detection CH2 CH setting 1 for deviation detection between channel CH setting 2 for deviation detection between channel	☞ Page 694 Operation			

## Offset/gain setting function

37

FX5-4A-ADP

FX5-4AD-ADP

FX5-4DA-ADP

FX5-4AD-PT-ADP

FX5-4AD-TC-ADP

This function sets any analog value to the offset/gain value without regard to the setting prepared in advance as the analog range. The set value is saved in the built-in memory of the analog adapter.

For changing the offset/gain data, set an analog value to the "offset setting value" or "gain setting value".

The table below shows the available setting range.

Item	Description	Setting range	
		Voltage input (mV)	Current input (μA)
Offset setting value	Analog input value when the digital value is 0 (offset reference value)	-10000 to +9000	-20000 to +17000
Gain setting value	Analog input value when the digital value becomes the gain reference value	-9000 to +10000	-17000 to +30000

### Point

An offset/gain setting value range error occurs when the following condition is not satisfied: (Error code: 1A9□H)

- During voltage input:  $1000 \leq \text{Gain setting value} - \text{Offset setting value}$
- During current input:  $3000 \leq \text{Gain setting value} - \text{Offset setting value} \leq 30000$

The table below shows the reference value and initial value of the offset/gain setting value.

Description		Digital output value	Offset setting value		Gain setting value	
Voltage/current	Input range		Reference value	Default value	Reference value	Default value
Voltage	0 to 10V	0 to 16000	0	0 mV	8000	5000 mV
	0 to 5V	0 to 16000	0	0 mV	16000	5000 mV
	1 to 5V	0 to 12800	0	1000 mV	12800	5000 mV
	-10 to +10V	-8000 to +8000	0	0 mV	4000	5000 mV
Current	0 to 20mA	0 to 16000	0	0 μA	16000	20000 μA
	4 to 20mA	0 to 12800	0	4000 μA	12800	20000 μA
	-20 to +20mA	-8000 to +8000	0	0 μA	8000	20000 μA

## Operation

### ■Offset/gain writing

For changing the offset/gain data, set "E20FH" to the "offset/gain writing enable code" and set the "offset/gain writing" from OFF to ON to write the "input range setting", "offset setting value" and "gain setting value" to the built-in memory of the analog adapter. Only 1 range can be changed for 1 channel, and the latest contents are valid.

When writing is completed, the "offset/gain writing" automatically turns OFF. Also, the "offset/gain writing enable code" is cleared to 0.

When the "input range setting" is changed, the initial value becomes valid.

For returning the offset/gain data to the initial value, use the offset/gain initialization function (  Page 702 Offset/gain initialization function)

#### Point

- The offset/gain value is written when the "offset/gain writing enable code" is set to "E20FH".
- The offset/gain value can be written only while A/D conversion is disabled.
- The "A/D conversion enable/disable setting" cannot be changed to "enable" while the offset/gain value is being written.

### ■Offset/gain reading

For reading the offset/gain data saved in the built-in memory of the analog adapter, set the "offset/gain reading" from OFF to ON to read the "input range setting", "offset setting value" and "gain setting value" from the built-in memory of the analog adapter.

When the input range setting during reading is the same as the input range setting in the built-in memory of the analog adapter, the read values are set to the "offset setting value" and "gain setting value". If the input range setting is different, the initial value of the input range setting selected during reading is valid and set to the "offset setting value" and "gain setting value". In this case, the offset/gain setting input range mismatch alarm occurs (Alarm code: 0C0□H)

## Setting procedure

Access to the offset/gain setting window in the GX Works3 to set the offset and gain values.

The setting procedure for the offset/gain setting of the FX5-4A-ADP is as follows:

 [Tool] ⇒ [Module Tool List]

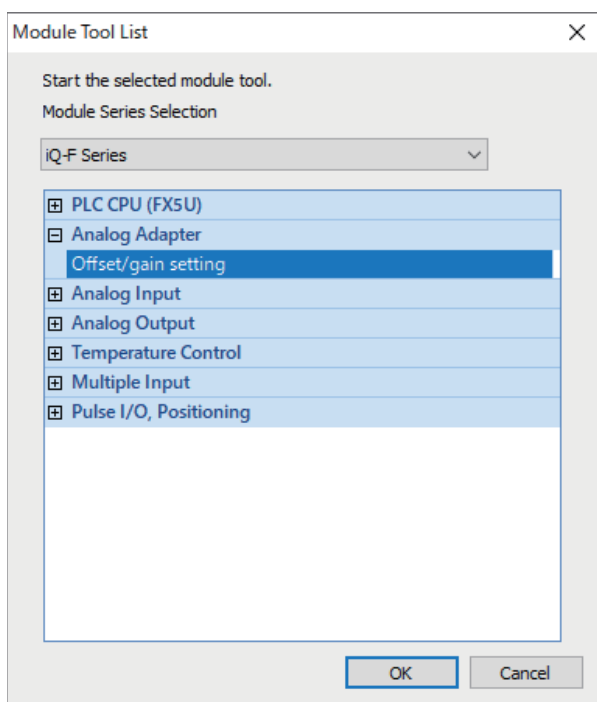

1. In "Analog Adapter", select "Offset/gain setting" and click [OK] button.

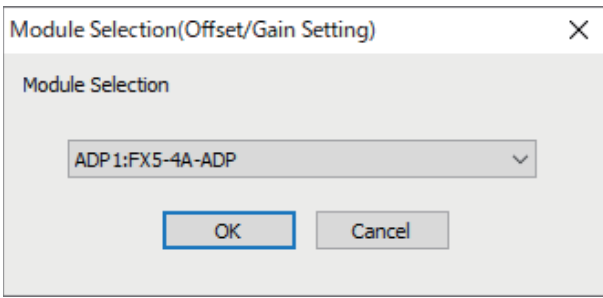

2. Select the target module for the offset/gain setting, and click [OK] button.

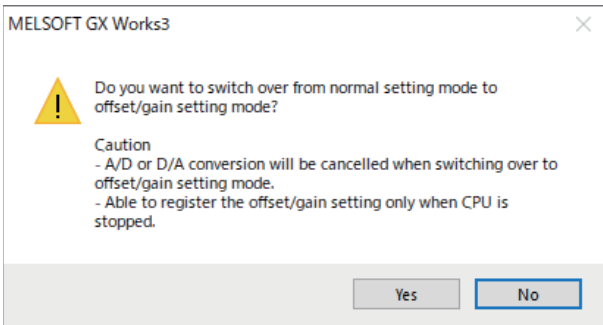

3. Click [Yes] button.

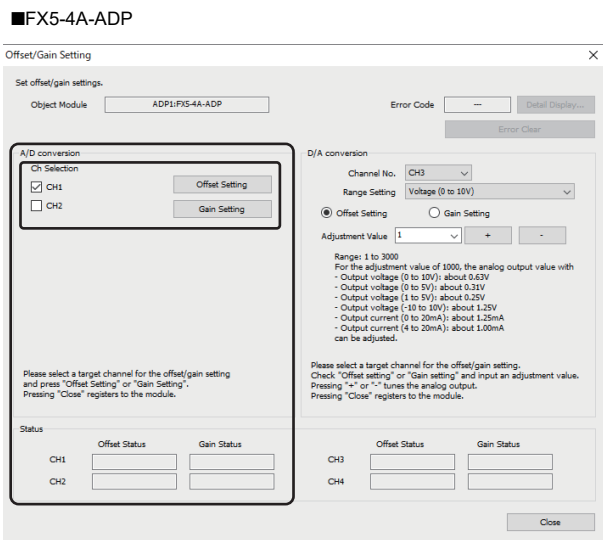

4. Execute the settings in A/D conversion. Mark the checkbox of the channel where offset and gain values are to be set, and click [Offset Setting] button.

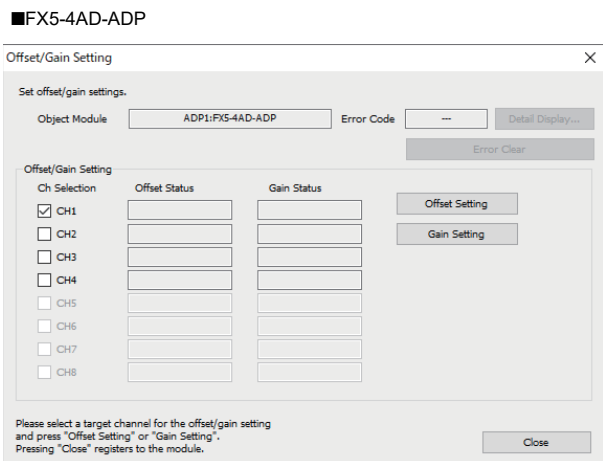

5. Apply the offset voltage or current to the terminal of the corresponding channel, and click [Yes] button.

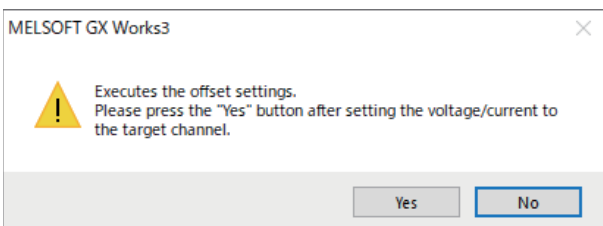

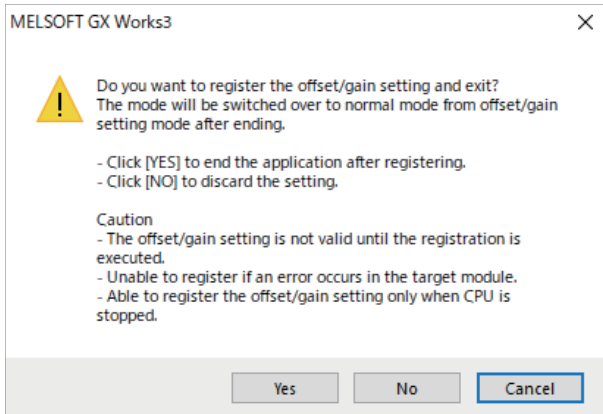
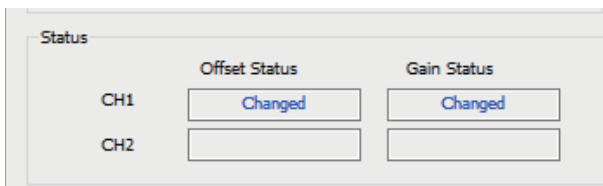
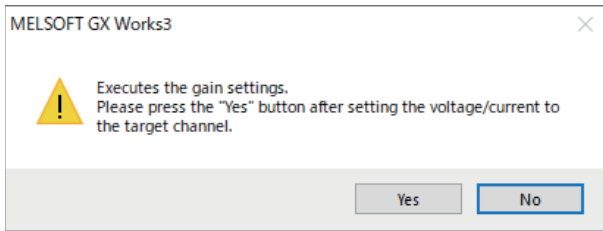
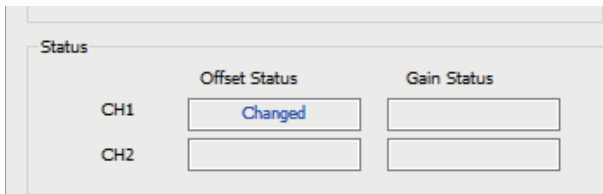

6. Check that "Offset Status" has changed to "Changed", and click [Gain Setting] button.

7. Apply the gain voltage or current to the terminal of the corresponding channel, and click [Yes] button.

8. Check that "Gain Status" has changed to "Changed", and click [Close] button.

9. Click [Yes] button.

## Corresponding devices

The devices which are used by the offset/gain setting function are listed below.

Name	Connection part	Special relay			
		CH1	CH2	CH3 <sup>*1</sup>	CH4 <sup>*1</sup>
Offset/gain reading	1st adapter	SM6332	SM6372	SM6412	SM6452
	2nd adapter	SM6692	SM6732	SM6772	SM6812
	3rd adapter	SM7052	SM7092	SM7132	SM7172
	4th adapter	SM7412	SM7452	SM7492	SM7532
Offset/gain writing	1st adapter	SM6333	SM6373	SM6413	SM6453
	2nd adapter	SM6693	SM6733	SM6773	SM6813
	3rd adapter	SM7053	SM7093	SM7133	SM7173
	4th adapter	SM7413	SM7453	SM7493	SM7533
Offset setting value	1st adapter	SD6332	SD6372	SD6412	SD6452
	2nd adapter	SD6692	SD6732	SD6772	SD6812
	3rd adapter	SD7052	SD7092	SD7132	SD7172
	4th adapter	SD7412	SD7452	SD7492	SD7532
Gain setting value	1st adapter	SD6333	SD6373	SD6413	SD6453
	2nd adapter	SD6693	SD6733	SD6773	SD6813
	3rd adapter	SD7053	SD7093	SD7133	SD7173
	4th adapter	SD7413	SD7453	SD7493	SD7533
Offset/gain writing enable code	1st adapter	SD6334	SD6374	SD6414	SD6454
	2nd adapter	SD6694	SD6734	SD6774	SD6814
	3rd adapter	SD7054	SD7094	SD7134	SD7174
	4th adapter	SD7414	SD7454	SD7494	SD7534

\*1 Only used by the FX5-4AD-ADP.

The details of the device used are listed below.

Name	Description	Setting value	Description	Default value	R/W
Offset/gain reading	An offset/gain setting value is read.	0: OFF	Offset/gain reading is not performed.	0: OFF	R/W
		1: ON	Offset/gain reading is performed.		
Offset/gain writing	An offset/gain setting value is written in.	0: OFF	Offset/gain writing is not performed.	0: OFF	R/W
		1: ON	Offset/gain writing is performed.		

Item	Description	Setting range		Default value	R/W
		Voltage input (mV)	Current input (μA)		
Offset setting value	Set the offset data/gain data used in the offset/gain setting function.	-10000 to +9000	-20000 to +17000	0	R/W
Gain setting value		-9000 to +10000	-17000 to +30000	Voltage output: 5000 Current output: 20000	R/W

Name	Description	Range	Default value	R/W
Offset/gain writing enable code	Set the offset/gain writing enable code used for changing the offset/gain.	Offset/gain writing enable: E20FH Offset/gain writing disable: Other than E20FH	0	R/W

# Offset/gain initialization function

FX5-4A-ADP

FX5-4AD-ADP

FX5-4DA-ADP

FX5-4AD-PT-ADP

FX5-4AD-TC-ADP

This function initializes the offset and gain values in the built-in memory of the analog adapter.  
This function can be set only with special devices.

## Operation

Set "A/D conversion: E20FH" to "offset/gain writing enable code" and set the "offset/gain initialization" from OFF to ON to initialize the offset value and gain value saved in the built-in memory of the analog adapter. When initialization is completed, the "offset/gain initialization" automatically turns OFF. Also, the "offset/gain writing enable code" is cleared to 0.

### Point

- Offset/gain initialization is executed when the "offset/gain writing enable code" is set to "E20FH".
- Offset/gain initialization is enabled only while A/D conversion is disabled.
- The "A/D conversion enable/disable setting" cannot be changed to "enable" while offset/gain initialization is being executed.

## Setting procedure

1. Set "E20FH" to the "offset/gain writing enable code".

Setting value	Description	Default value
Other than E20FH	Offset/gain writing disable	0
E20FH	Offset/gain writing enable	

2. Set the "offset/gain initialization" from OFF to ON.

Setting value	Description	Default value
0: OFF	Offset/gain initialization is not performed.	0: OFF
1: ON	Offset/gain initialization is performed.	

## Corresponding devices

The devices which are used by the offset/gain initialization function are listed below.

Name	Connection part	Special relay			
		CH1	CH2	CH3*1	CH4*1
Offset/gain initialization	1st adapter	SM6334	SM6374	SM6414	SM6454
	2nd adapter	SM6694	SM6734	SM6774	SM6814
	3rd adapter	SM7054	SM7094	SM7134	SM7174
	4th adapter	SM7414	SM7454	SM7494	SM7534
Offset/gain writing enable code	1st adapter	SD6334	SD6374	SD6414	SD6454
	2nd adapter	SD6694	SD6734	SD6774	SD6814
	3rd adapter	SD7054	SD7094	SD7134	SD7174
	4th adapter	SD7414	SD7454	SD7494	SD7534

\*1 Only used by the FX5-4AD-ADP.

The details of the device used are listed below.

Name	Description	Setting value	Description	Default value	R/W
Offset/gain initialization	An offset/gain setting value is initialized.	0: OFF	Offset/gain initialization is not performed.	0: OFF	R/W
		1: ON	Offset/gain initialization is performed.		
Name	Description	Range		Default value	R/W
Offset/gain writing enable code	Set the offset/gain writing enable code used for changing the offset/gain.	Offset/gain writing enable: E20FH Offset/gain writing disable: Other than E20FH		0	R/W



# 37.7 Functions (Analog Output)

This section describes details of the D/A conversion functions and how to set them using the GX Works3.

## D/A conversion enable/disable function



Set whether to enable or disable D/A conversion for each channel.

### Operation

Digital values are D/A-converted only for channels whose "D/A conversion enable/disable setting" is set to "D/A conversion enable". The channels for which the "D/A output enable/disable setting" is set to "enable" output the converted analog value. If "D/A conversion enable/disable setting" is changed from D/A conversion enable to D/A conversion disable, the digital value is held as is, and the digital operation value and analog output value monitor will be cleared.

### Setting methods

Set "D/A conversion enable/disable setting" to "D/A conversion enable" or "D/A conversion disable".

Navigation window ⇒ [Parameter] ⇒ [Module Information] ⇒ Module model name ⇒ [Module Parameter] ⇒ "Basic Settings" ⇒ "D/A Conversion Enable/Disable Setting"

### Corresponding devices

The devices which are used by the D/A conversion enable/disable setting function are listed below.

Name	Connection part	Special relay			
		CH1 <sup>*1</sup>	CH2 <sup>*1</sup>	CH3	CH4
D/A conversion enable/disable setting	1st adapter	SM6300	SM6340	SM6380	SM6420
	2nd adapter	SM6660	SM6700	SM6740	SM6780
	3rd adapter	SM7020	SM7060	SM7100	SM7140
	4th adapter	SM7380	SM7420	SM7460	SM7500

\*1 Only used by the FX5-4DA-ADP.

The details of the device used are listed below.

Name	Description	Setting value	Description	Default value	R/W
D/A conversion enable/disable setting	Set whether to enable or disable D/A conversion.	0: OFF	D/A conversion enable	1: ON	R/W
		1: ON	D/A conversion disable		

# Range switching function

FX5-4A-ADP

FX5-4AD-ADP

FX5-4DA-ADP

FX5-4AD-PT-ADP

FX5-4AD-TC-ADP

The output range of the analog output can be switched for each channel.

Switching the range makes it possible to change the output conversion characteristics.

## Operation

The output range is switched when the "output range setting" is changed while the "D/A conversion enable/disable setting" is set to "disable".

When the output range is switched, the following special devices are initialized:

Name	Connection part	Special device			
		CH1 <sup>*2</sup>	CH2 <sup>*2</sup>	CH3	CH4
Warning output upper limit value flag	1st adapter	SM6311	SM6351	SM6391	SM6431
	2nd adapter	SM6671	SM6711	SM6751	SM6791
	3rd adapter	SM7031	SM7071	SM7111	SM7151
	4th adapter	SM7391	SM7431	SM7471	SM7511
Warning output lower limit value flag	1st adapter	SM6312	SM6352	SM6392	SM6432
	2nd adapter	SM6672	SM6712	SM6752	SM6792
	3rd adapter	SM7032	SM7072	SM7112	SM7152
	4th adapter	SM7392	SM7432	SM7472	SM7512
Disconnection detection flag	1st adapter	SM6318	SM6358	SM6398	SM6438
	2nd adapter	SM6678	SM6718	SM6758	SM6798
	3rd adapter	SM7038	SM7078	SM7118	SM7158
	4th adapter	SM7398	SM7438	SM7478	SM7518
Digital operation value	1st adapter	SD6301	SD6341	SD6381	SD6421
	2nd adapter	SD6661	SD6701	SD6741	SD6781
	3rd adapter	SD7021	SD7061	SD7101	SD7141
	4th adapter	SD7381	SD7421	SD7461	SD7501
Analog output value monitor	1st adapter	SD6302	SD6342	SD6382	SD6422
	2nd adapter	SD6662	SD6702	SD6742	SD6782
	3rd adapter	SD7022	SD7062	SD7102	SD7142
	4th adapter	SD7382	SD7422	SD7462	SD7502
Offset setting value <sup>*1</sup>	1st adapter	SD6332	SD6372	SD6412	SD6452
	2nd adapter	SD6692	SD6732	SD6772	SD6812
	3rd adapter	SD7052	SD7092	SD7132	SD7172
	4th adapter	SD7412	SD7452	SD7492	SD7532
Gain setting value <sup>*1</sup>	1st adapter	SD6333	SD6373	SD6413	SD6453
	2nd adapter	SD6693	SD6733	SD6773	SD6813
	3rd adapter	SD7053	SD7093	SD7133	SD7173
	4th adapter	SD7413	SD7453	SD7493	SD7533

\*1 When the output range setting after change is equivalent to the output range setting set by the offset/gain setting function, the values set by the offset/gain setting function are reflected. In any other case, they are initialized to the initial value.

\*2 CH1 and CH2 are only used by the FX5-4DA-ADP.

## Setting procedure

Set the output range to be used in the "output range setting".

 Navigation window ⇒ [Parameter] ⇒ [Module Information] ⇒ Module model name ⇒ [Module Parameter] ⇒ "Basic Settings" ⇒ "Range switching function"

Output range setting	Digital input range
0 to 10V	0 to 16000
0 to 5V	0 to 16000
1 to 5V	0 to 16000
-10 to +10V	-8000 to +8000
0 to 20mA	0 to 16000
4 to 20mA	0 to 16000

## Corresponding devices

The devices which are used by the range switching function are listed below.

Name	Connection part	Special register			
		CH1*1	CH2*1	CH3	CH4
Output range setting	1st adapter	SD6305	SD6345	SD6385	SD6425
	2nd adapter	SD6665	SD6705	SD6745	SD6785
	3rd adapter	SD7025	SD7065	SD7105	SD7145
	4th adapter	SD7385	SD7425	SD7465	SD7505

\*1 Only used by the FX5-4DA-ADP.

The details of the device used are listed below.

Name	Description	Setting value	Description	Default value	R/W
Output range setting	Set the output range. If a value other than the setting value is set, the range setting range error (error code: 1B8□H) occurs.	0	0 to 10V	0	R/W
		1	0 to 5V		
		2	1 to 5V		
		3	-10 to +10V		
		4	0 to 20mA		
		5	4 to 20mA		

## Shift function



This function adds (shifts) the set input value shift amount to the digital value and stores it in "Digital operation value". When the input value shift amount is changed, the change will be reflected in the digital operation value in real time, allowing fine adjustments to be easily performed during system startup.

## Operation

The set "Input value shift amount" is added to the digital value. The added digital value is stored in "Digital operation value". When the digital operation value resulting from the shift processing exceeds the range of -32768 to +32767, the value is fixed to the lower limit (-32768) or the upper limit (+32767).

### Point

When the scaling function is used together, the scaling processing is executed to the value after shifting.

## Setting procedure

Set the shift amount to "Input value shift amount".

Navigation window ⇒ [Parameter] ⇒ [Module Information] ⇒ Module model name ⇒ [Module Parameter] ⇒ "Application Settings" ⇒ "Shift Function"

Item	Setting range	Default value	R/W
Input value shift amount	-32768 to +32767	0	R/W

## Corresponding devices

The devices which are used by the shift function are listed below.

Name	Connection part	Special register			
		CH1*1	CH2*1	CH3	CH4
Input value shift amount	1st adapter	SD6310	SD6350	SD6390	SD6430
	2nd adapter	SD6670	SD6710	SD6750	SD6790
	3rd adapter	SD7030	SD7070	SD7110	SD7150
	4th adapter	SD7390	SD7430	SD7470	SD7510

\*1 Only used by the FX5-4DA-ADP.

The details of the device used are listed below.

Name	Description	Range	Default value	R/W
Input value shift amount	Set the "input value shift amount" used in the shift function. The set value is added to the "digital value".	-32768 to +32767	0	R/W

## Setting example

Ex.

When the output range is 0 to 5V and the input value shift amount is +50

Analog output voltage (V)

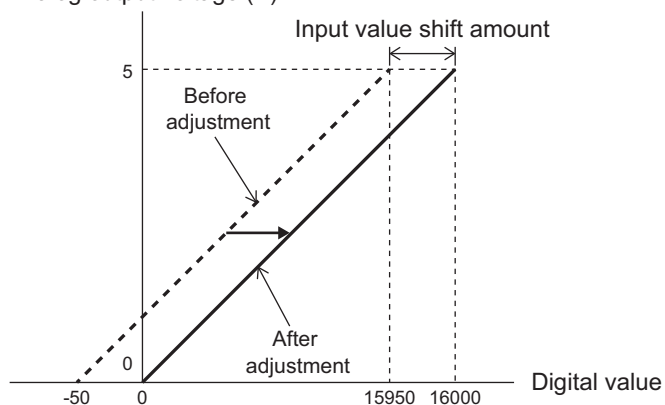

Digital value	Digital operation value	Analog output voltage (V)
Before adjustment	After adjustment	
-50	0	0
15950	16000	5

# Warning output function



A warning will be output when the digital operation value after shift addition exceeds the warning output upper limit value or is less than the warning output lower limit value.

## Operation

When the digital operation value after shift addition is greater than or equal to the warning output upper limit value or less than the warning output lower limit value and satisfies the conditions for warning output, "warning output upper flag" or "warning output lower flag" turns ON.

When a warning is output, the setting value of the warning output upper limit value/warning output lower limit value is regarded as the digital operation value and D/A-converted.

After a warning is output, even if the digital value changes to below the warning output upper limit value and above the warning output lower limit value, the "warning output upper flag" and "warning output lower flag" will not turn OFF. When the alarm clear request is set to OFF, ON and OFF again, the "warning output upper flag" and "warning output lower flag" turn OFF. The "warning output upper flag" and "warning output lower flag" also turn OFF when the "warning output setting" is changed to "disable", but the alarm code stored in the "D/A conversion latest alarm code" is not cleared.

For clearing the alarm code stored in the "D/A conversion latest alarm code", set the alarm clear request to OFF, ON and OFF again.

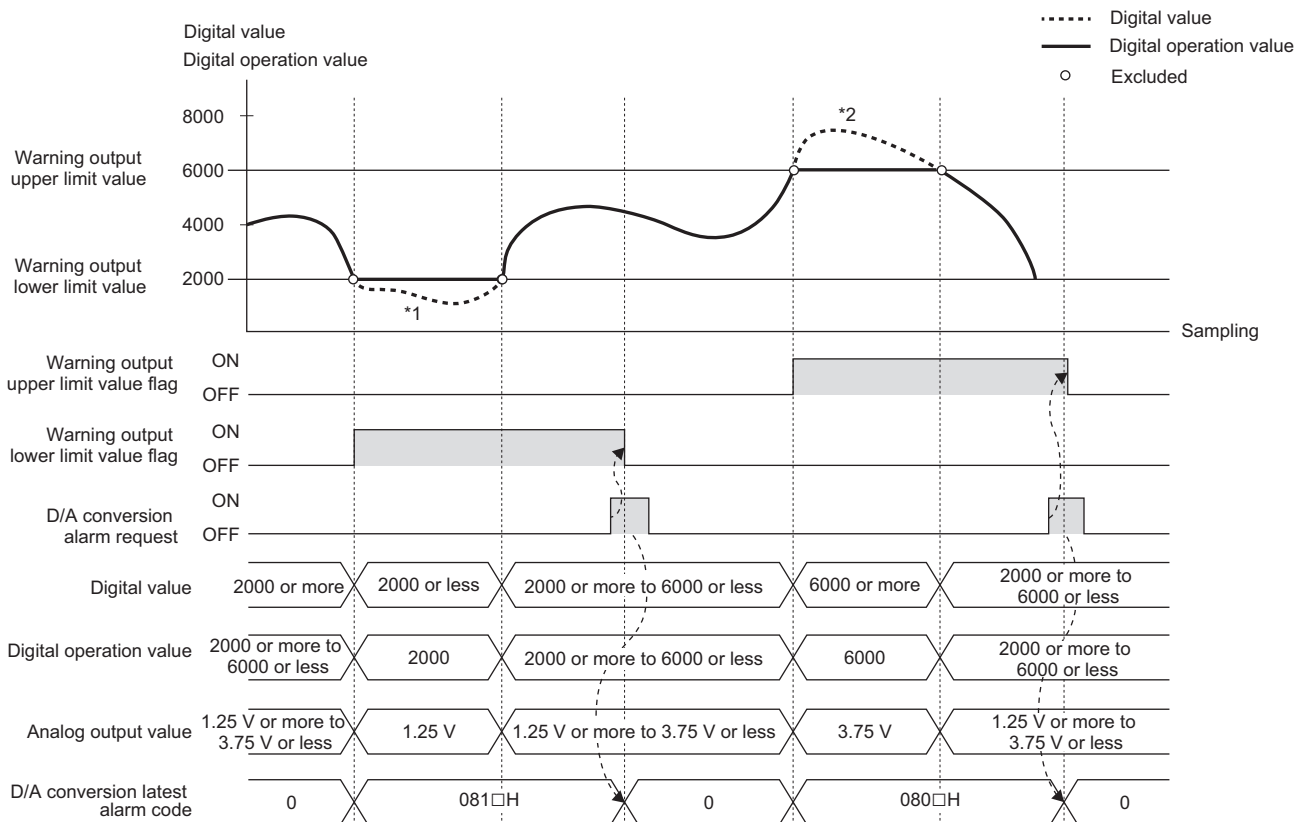

\*1 Analog values below the warning output lower limit value are not output.  
 \*2 Analog values above the warning output upper limit value are not output.

## Setting procedure

1. Set "Warning Output Function" to "Enable".

 Navigation window ⇒ [Parameter] ⇒ [Module Information] ⇒ Module model name ⇒ [Module Parameter] ⇒ "Application Settings" ⇒ "Warning Output Function"

2. Set values for "Warning output upper limit value" and "Warning output lower limit value".

Item	Setting range
Warning output upper limit value	-32768 to +32767
Warning output lower limit value	

### Point

Set the warning output upper limit value and warning output lower limit value while satisfying the condition "Warning output upper limit value > Warning output lower limit value".

## Corresponding devices

The devices which are used by the warning output function are listed below.

Name	Connection part	Special relay			
		CH1*1	CH2*1	CH3	CH4
Warning output upper limit value flag	1st adapter	SM6311	SM6351	SM6391	SM6431
	2nd adapter	SM6671	SM6711	SM6751	SM6791
	3rd adapter	SM7031	SM7071	SM7111	SM7151
	4th adapter	SM7391	SM7431	SM7471	SM7511
Warning output lower limit value flag	1st adapter	SM6312	SM6352	SM6392	SM6432
	2nd adapter	SM6672	SM6712	SM6752	SM6792
	3rd adapter	SM7032	SM7072	SM7112	SM7152
	4th adapter	SM7392	SM7432	SM7472	SM7512
Warning output setting	1st adapter	SM6313	SM6353	SM6393	SM6433
	2nd adapter	SM6673	SM6713	SM6753	SM6793
	3rd adapter	SM7033	SM7073	SM7113	SM7153
	4th adapter	SM7393	SM7433	SM7473	SM7513
Warning output upper limit value	1st adapter	SD6311	SD6351	SD6391	SD6431
	2nd adapter	SD6671	SD6711	SD6751	SD6791
	3rd adapter	SD7031	SD7071	SD7111	SD7151
	4th adapter	SD7391	SD7431	SD7471	SD7511
Warning output lower limit value	1st adapter	SD6312	SD6352	SD6392	SD6432
	2nd adapter	SD6672	SD6712	SD6752	SD6792
	3rd adapter	SD7032	SD7072	SD7112	SD7152
	4th adapter	SD7392	SD7432	SD7472	SD7512

\*1 Only used by the FX5-4DA-ADP.

The details of the device used are listed below.

Name	Description	Monitor value	Display description	Default value	R/W
Warning output upper limit value flag	These flags monitor the upper limit value warning or lower limit value warning of warning output.	0: OFF	Normal	0: OFF	R
Warning output lower limit value flag		1: ON	Warning output upper limit/ lower limit detection		
Warning output setting	Set whether to enable or disable the warning output.	0: OFF	Warning output enable	1: ON	R/W
		1: ON	Warning output disable		
Name	Description	Range	Default value	R/W	
Warning output upper limit value	Set the upper and lower limit values of the warning output function.	-32768 to +32767	0	R/W	
Warning output lower limit value					

# Scaling function

FX5-4A-ADP

FX5-4AD-ADP

FX5-4DA-ADP

FX5-4AD-PT-ADP

FX5-4AD-TC-ADP

This function performs the scale conversion on digital values within a specified range between a scaling upper limit value and a scaling lower limit value.

The program for scale conversion can be omitted.

## Operation

This function performs the scale conversion on digital values within the range between the scaling upper limit value and scaling lower limit value and stores the converted value in "Digital operation value". The value after the scale conversion is used for the D/A conversion. (The value below the decimal point obtained by the conversion is rounded off.)

### ■ Concept of scaling setting

Ex.

When the output range is set to -10 to +10V

For the scaling lower limit value, set a value corresponding to the lower limit value of the output range (-8000).

For the scaling upper limit value, set a value corresponding to the upper limit value of the output range (+8000).

### ■ Calculating the scaling value

The scale conversion is based on the following formula. (The value below the decimal point obtained by scale conversion is rounded off.)

Calculation formula	Symbol
$\text{Digital value used for D/A conversion} = \frac{D_{\text{Max}} - D_{\text{Min}}}{S_{\text{H}} - S_{\text{L}}} \times (D_{\text{X}} - S_{\text{L}}) + D_{\text{Min}}$	D <sub>X</sub> : Digital value D <sub>Max</sub> : Maximum value of digital input for the output range in use D <sub>Min</sub> : Minimum value of digital input for the output range in use S <sub>H</sub> : Scaling upper limit value S <sub>L</sub> : Scaling lower limit value

## Setting procedure

1. Set "D/A conversion enable/disable setting" to "D/A conversion enable".

Navigation window ⇒ [Parameter] ⇒ [Module Information] ⇒ Module model name ⇒ [Module Parameter] ⇒ "Basic Settings" ⇒ "D/A Conversion Enable/Disable Setting"

2. Set the "scaling enable/disable setting" to "enable".

Navigation window ⇒ [Parameter] ⇒ [Module Information] ⇒ Module model name ⇒ [Module Parameter] ⇒ "Application Settings" ⇒ "Scaling Setting"

3. Set values for "Scaling upper limit value" and "Scaling lower limit value".

Item	Setting range
Scaling upper limit value	-32768 to +32767
Scaling lower limit value	-32768 to +32767

### Point

- If the relation between the values is scaling lower limit value > scaling upper limit value, the scale conversion can be performed according to a negative slope.
- Set the scaling with the condition "Scaling lower limit value ≠ Scaling upper limit value".

## Corresponding devices

The devices which are used by the scaling function are listed below.

Name	Connection part	Special relay			
		CH1 <sup>*1</sup>	CH2 <sup>*1</sup>	CH3	CH4
Scaling enable/disable setting	1st adapter	SM6308	SM6348	SM6388	SM6428
	2nd adapter	SM6668	SM6708	SM6748	SM6788
	3rd adapter	SM7028	SM7068	SM7108	SM7148
	4th adapter	SM7388	SM7428	SM7468	SM7508
Scaling upper limit value	1st adapter	SD6308	SD6348	SD6388	SD6428
	2nd adapter	SD6668	SD6708	SD6748	SD6788
	3rd adapter	SD7028	SD7068	SD7108	SD7148
	4th adapter	SD7388	SD7428	SD7468	SD7508
Scaling lower limit value	1st adapter	SD6309	SD6349	SD6389	SD6429
	2nd adapter	SD6669	SD6709	SD6749	SD6789
	3rd adapter	SD7029	SD7069	SD7109	SD7149
	4th adapter	SD7389	SD7429	SD7469	SD7509

\*1 Only used by the FX5-4DA-ADP.

The details of the device used are listed below.

Name	Description	Setting value	Description	Default value	R/W
Scaling enable/disable setting	Set whether to enable or disable the scaling function.	0: OFF	Scaling function enable	1: ON	R/W
		1: ON	Scaling function disable		
Name	Description	Range	Default value	R/W	
Scaling upper limit value Scaling lower limit value	Set the upper and lower limit values of the scaling conversion range.	-32768 to +32767	0	R/W	

## Setting example

**Ex.**

When 5000 is set to the scaling upper limit value and 1000 is set to the scaling lower limit value for the channel with the output range of 0 to 5V

Analog output voltage (V)

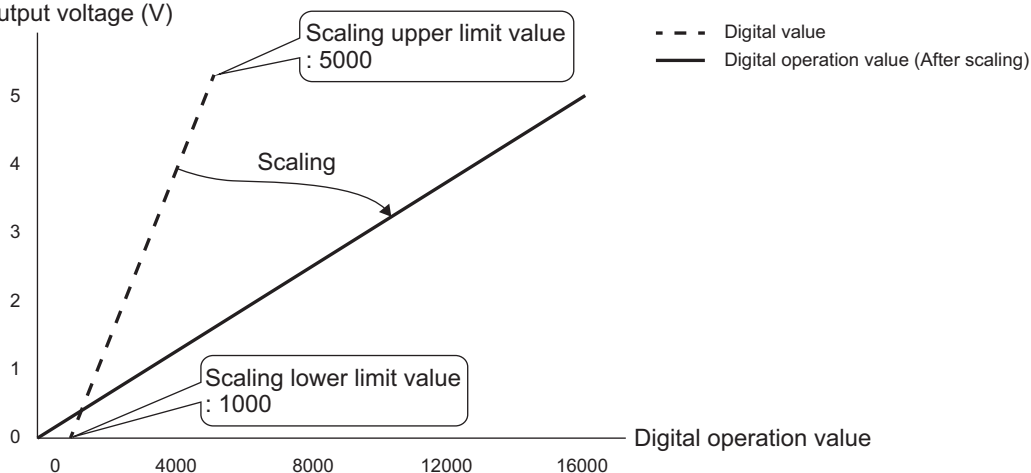

Digital value	Digital operation value (after scaling)	Output voltage (V)
1000	0	0
1800	3200	1
2600	6400	2
3400	9600	3
4200	12800	4
5000	16000	5



**Ex.**

When 1000 is set to the scaling upper limit value and 5000 is set to the scaling lower limit value for the channel with the output range of 0 to 5V

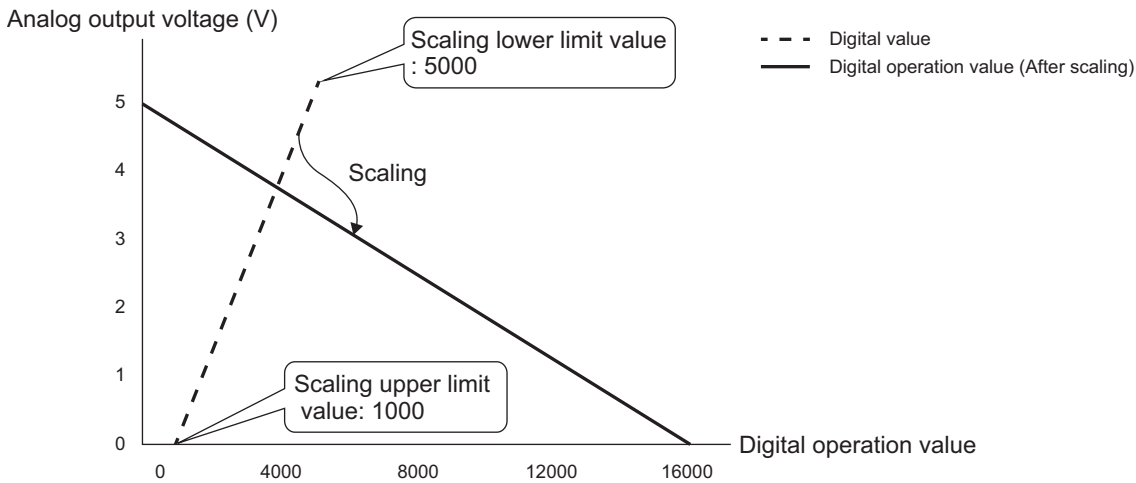

Digital value	Digital operation value (after scaling)	Output voltage (V)
1000	16000	0
1800	12800	1
2600	9600	2
3400	6400	3
4200	3200	4
5000	0	5

## Analog output HOLD/CLEAR function

FX5-4A-ADP
FX5-4AD-ADP
FX5-4DA-ADP
FX5-4AD-PT-ADP
FX5-4AD-TC-ADP

Set whether to clear the output analog output value or to hold the previous value or setting value in accordance with the CPU module operation status (RUN, STOP or STOP (by stop error)).

### Operation

When the CPU module operation status becomes "RUN", "STOP" or "STOP (by stop error)", the FX5-4A-ADP becomes the analog output status shown in the table below in accordance with the combination of "HOLD/CLEAR setting" and "D/A output enable/disable setting".

CPU module status	D/A conversion enable/disable setting	D/A output enable/disable setting	Analog output HOLD/CLEAR setting	Output status
RUN	Enabled	Enabled	All settings	The value after a shift and scaling
		Disabled	All settings	Offset value
	Disabled	Enabled	All settings	0
		Disabled	All settings	0
STOP (RUN → STOP, PAUSE → STOP, stop error)	Enabled	Enabled	CLEAR	The value with K0 set to the digital value is output.
			Previous Value (Hold)	The value after a shift and scaling
			Setting Value	The value set as the HOLD setting value is output.
		Disabled	All settings	Offset value
	Disabled	Enabled	All settings	0
		Disabled	All settings	0
PAUSE	Enabled	Enabled	All settings	The value after a shift and scaling
		Disabled	All settings	Offset value
	Disabled	Enabled	All settings	0
		Disabled	All settings	0

## Setting methods

1. Set "HOLD/CLEAR Setting" to "CLEAR", "Previous Value (hold)", or "Setting Value".

Navigation window ⇒ [Parameter] ⇒ [Module Information] ⇒ Module model name ⇒ [Module Parameter] ⇒ "Application Settings" ⇒ "Analog Output HOLD/CLEAR Setting" ⇒ "HOLD/CLEAR Setting"

2. It is the above 1, and when "Setting Value" is chosen, a value is set to HOLD setting value.

Navigation window ⇒ [Parameter] ⇒ [Module Information] ⇒ Module model name ⇒ [Module Parameter] ⇒ "Application Settings" ⇒ "Analog Output HOLD/CLEAR Setting" ⇒ "HOLD Setting Value"

Item	Setting range
HOLD setting value	-32768 to +32767

## Corresponding devices

The devices which are used by the analog output HOLD/CLEAR function are listed below.

Name	Connection part	Special register			
		CH1*1	CH2*1	CH3	CH4
HOLD/CLEAR function setting	1st adapter	SD6303	SD6343	SD6383	SD6423
	2nd adapter	SD6663	SD6703	SD6743	SD6783
	3rd adapter	SD7023	SD7063	SD7103	SD7143
	4th adapter	SD7383	SD7423	SD7463	SD7503
HOLD setting value	1st adapter	SD6304	SD6344	SD6384	SD6424
	2nd adapter	SD6664	SD6704	SD6744	SD6784
	3rd adapter	SD7024	SD7064	SD7104	SD7144
	4th adapter	SD7384	SD7424	SD7464	SD7504

\*1 Only used by the FX5-4DA-ADP.

The details of the device used are listed below.

Name	Description	Setting value	Description	Default value	R/W
HOLD/CLEAR function setting	Set whether to hold (HOLD) or clear (CLEAR) the analog output value that was being output when the operation status of the CPU module is STOP or a stop error. • If a value other than the setting value is set, the output status setting range error during HOLD (error code: 1B1□H) occurs. • Set a value to the "HOLD setting value" when setting "2" here.	0	CLEAR	1	R/W
		1	Previous Value (Hold)		
		2	HOLD setting value		
Name	Description	Range	Default value	R/W	
HOLD setting value	Set the output value when "2: HOLD setting value" is set to the HOLD/CLEAR function setting.	-32768 to +32767	0	R/W	

## D/A output enable/disable setting function



Specify whether to output the D/A conversion value or offset value for each channel.

The conversion speed is a constant, regardless of the output enable/disable state.

## Operation

For channels for which "D/A output enable/disable setting" is set to "D/A output enable", the digital values are D/A-converted and the resultant analog values are output.

The channels for which the "D/A output enable/disable setting" is set to "disable" output the offset value.

## Setting methods

Set "D/A output enable/disable setting" to "D/A output enable" or "D/A output disable".

Navigation window ⇒ [Parameter] ⇒ [Module Information] ⇒ Module model name ⇒ [Module Parameter] ⇒ "Basic Settings" ⇒ "D/A Output Enable/Disable Setting"

## Corresponding devices

The devices which are used by the D/A output enable/disable setting function are listed below.

Name	Connection part	Special relay			
		CH1*1	CH2*1	CH3	CH4
D/A output enable/disable setting	1st adapter	SM6301	SM6341	SM6381	SM6421
	2nd adapter	SM6661	SM6701	SM6741	SM6781
	3rd adapter	SM7021	SM7061	SM7101	SM7141
	4th adapter	SM7381	SM7421	SM7461	SM7501

\*1 Only used by the FX5-4DA-ADP.

The details of the device used are listed below.

Name	Description	Setting value	Description	Default value	R/W
D/A output enable/disable setting	Set whether to output the D/A conversion value or to output the offset value. The setting value will be ignored when the D/A conversion enable/disable setting is set to "disable".	0: OFF	D/A conversion value	1: ON	R/W
		1: ON	Offset value		

## Disconnection detection function



Disconnection can be detected in each channel.

This function is enabled when the analog output range is 4 to 20mA.

## Operation

When disconnection is detected in a channel for which the "D/A conversion enable/disable setting" is set to "D/A conversion enable" and the "disconnection detection enable/disable setting" is set to "enable", it is regarded as a disconnection detection error, and the "disconnection detection flag" turns ON. (Error code: 1BB□)

At this time, the digital value, digital operation value, and analog output value monitor will be cleared.

When the "disconnection recovery detection enable/disable setting" is set to "enable", the "disconnection detection flag" turns OFF when the channel is recovered from disconnection.

When the "disconnection recovery detection enable/disable setting" is set to "disable", the "disconnection detection flag" remains ON even if the channel is recovered from disconnection. To turn OFF "disconnection detection flag", it is necessary to set the "error clear request" (SM50) of the CPU module to ON. The "disconnection detection flag" turns OFF also when the "disconnection detection enable/disable setting" is changed to "disable".

■When the "disconnection detection recovery enable/disable setting" is set to "enable"

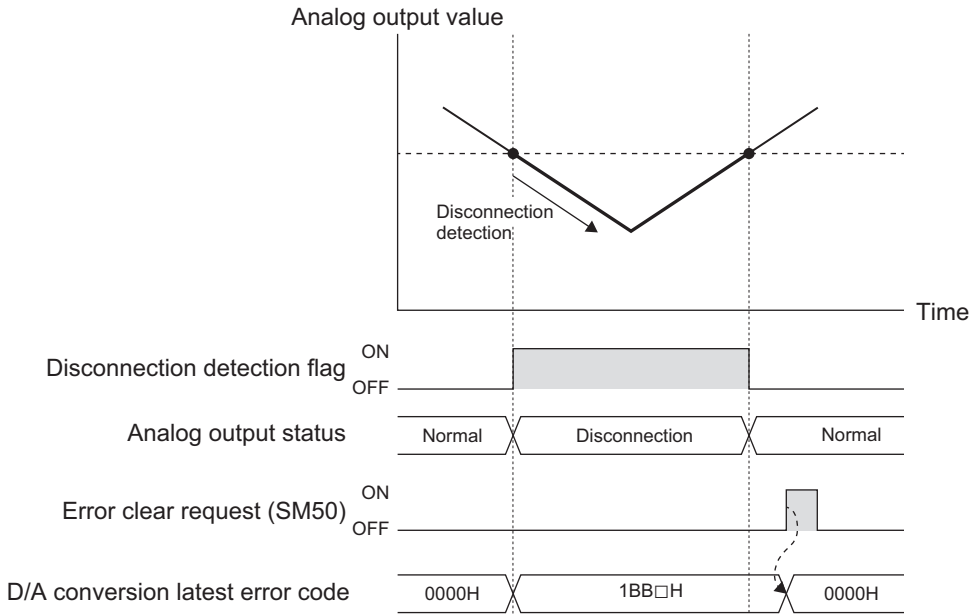

**Point**

- The "disconnection detection flag" automatically turns OFF.
- To clear "D/A conversion latest error code", set the "error clear request" (SM50) of the CPU module to ON.

■When the "disconnection detection recovery enable/disable setting" is set to "disable"

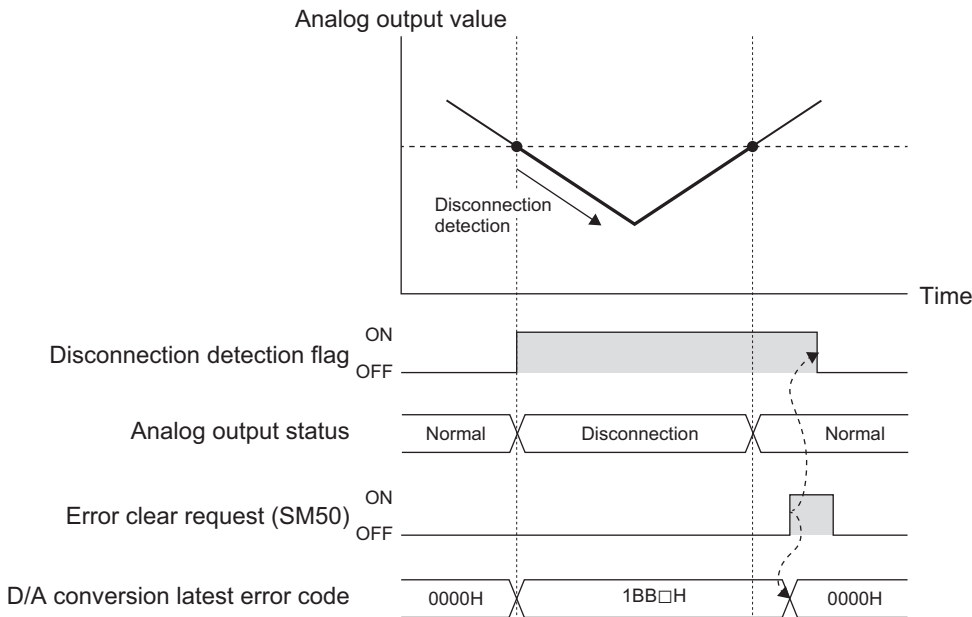

**Point**

- The "disconnection detection flag" does not turn OFF. To turn OFF this flag, set the "error clear request" (SM50) of the CPU module to ON.
- To clear "D/A conversion latest error code", set the "error clear request" (SM50) of the CPU module to ON.

## Setting procedure

1. Set "Disconnection detection enable/disable setting" to "Enable".

Navigation window ⇒ [Parameter] ⇒ [Module Information] ⇒ Module model name ⇒ [Module Parameter] ⇒ "Application Settings" ⇒ "Disconnection detection enable/disable setting"

2. Set "Disconnection recovery detection enable/disable setting".

Navigation window ⇒ [Parameter] ⇒ [Module Information] ⇒ Module model name ⇒ [Module Parameter] ⇒ "Application Settings" ⇒ "Disconnection recovery detection enable/disable setting"

## Corresponding devices

The devices which are used by the disconnection detection function are listed below.

Name	Connection part	Special relay			
		CH1 <sup>*1</sup>	CH2 <sup>*1</sup>	CH3	CH4
Disconnection detection flag	1st adapter	SM6318	SM6358	SM6398	SM6438
	2nd adapter	SM6678	SM6718	SM6758	SM6798
	3rd adapter	SM7038	SM7078	SM7118	SM7158
	4th adapter	SM7398	SM7438	SM7478	SM7518
Disconnection detection enable/disable setting	1st adapter	SM6319	SM6359	SM6399	SM6439
	2nd adapter	SM6679	SM6719	SM6759	SM6799
	3rd adapter	SM7039	SM7079	SM7119	SM7159
	4th adapter	SM7399	SM7439	SM7479	SM7519
Disconnection recovery detection enable/disable setting	1st adapter	SM6320	SM6360	SM6400	SM6440
	2nd adapter	SM6680	SM6720	SM6760	SM6800
	3rd adapter	SM7040	SM7080	SM7120	SM7160
	4th adapter	SM7400	SM7440	SM7480	SM7520

\*1 Only used by the FX5-4DA-ADP.

The details of the device used are listed below.

Name	Description	Monitor value	Display description	Default value	R/W
Disconnection detection flag	This flag monitors the disconnection detection.	0: OFF	Normal	0: OFF	R
		1: ON	Disconnection detection		
Disconnection detection enable/disable setting	Set whether to enable or disable the disconnection detection function.	0: OFF	Disconnection detection enable	1: ON	R/W
		1: ON	Disconnection detection disable		
Disconnection recovery detection enable/disable setting	Set whether to enable or disable the disconnection detection recovery.	0: OFF	Disconnection recovery detection enable	1: ON	R/W
		1: ON	Disconnection recovery detection disable		

## External power supply disconnection detection function

FX5-4A-ADP

FX5-4AD-ADP

FX5-4DA-ADP

FX5-4AD-PT-ADP

FX5-4AD-TC-ADP

This function detects that the external power supply (24VDC) is not supplied to the analog adapter or that the supply is shut off.

### Operation

The error occurs when the external power is not input. (Error code: 3081H)

#### ■FX5-4A-ADP

The error code is stored in "A/D conversion latest error code" of CH1 and "D/A conversion error flag" of CH1 turns ON.

When an error occurs, the analog function performs the following operation.

- A/D conversion function: Stops A/D conversion and holds the digital output value and digital operation value at the previous value.
- D/A conversion function: Stops the D/A conversion and outputs 0V/0mA.

### Setting procedure

The user does not need to configure any settings.

## Offset/gain setting function

FX5-4A-ADP

FX5-4AD-ADP

FX5-4DA-ADP

FX5-4AD-PT-ADP

FX5-4AD-TC-ADP

This function sets any analog value to the offset/gain value without regard to the setting prepared in advance as the analog range. The set value is saved in the built-in memory of the analog adapter.

For changing the offset/gain data, set an analog value to the "offset setting value" or "gain setting value".

The table below shows the available setting range.

Item	Description	Setting range	
		Voltage input (mV)	Current input (μA)
Offset setting value	Analog output value when the digital value is 0 (offset reference value)	-10000 to +9000	0 to 17000
Gain setting value	Analog output value when the digital value becomes the gain reference value	-9000 to +10000	3000 to 30000

#### Point

An offset/gain setting value range error occurs when the following condition is not satisfied: (Error code: 1A9□H)

- During voltage input:  $1000 \leq \text{Gain setting value} - \text{Offset setting value} \leq 10000$
- During current input:  $3000 \leq \text{Gain setting value} - \text{Offset setting value} \leq 30000$

The table below shows the reference value and initial value of the offset/gain setting value.

Description		Digital value	Offset setting value		Gain setting value	
Voltage/current	Output range		Reference value	Default value	Reference value	Default value
Voltage	0 to 10V	0 to 16000	0	0 mV	8000	5000 mV
	0 to 5V	0 to 16000	0	0 mV	16000	5000 mV
	1 to 5V	0 to 16000	0	1000 mV	16000	5000 mV
	-10 to +10V	-8000 to +8000	0	0 mV	4000	5000 mV
Current	0 to 20mA	0 to 16000	0	0 μA	16000	20000 μA
	4 to 20mA	0 to 16000	0	4000 μA	16000	20000 μA

## Operation

### ■ Offset/gain writing

For changing the offset/gain data, set "E210H" to the "offset/gain writing enable code" and set the "offset/gain writing" from OFF to ON to write the "output range setting", "offset setting value", and "gain setting value" to the built-in memory of the analog adapter. Only 1 range can be changed for 1 channel, and the latest contents are valid.

When writing is completed, the "offset/gain writing" automatically turns OFF. Also, the "offset/gain writing enable code" is cleared to 0.

When the "output range setting" is changed, the initial value becomes valid.

For returning the offset/gain data to the initial value, use the offset/gain initialization function (  Page 702 Offset/gain initialization function)

#### Point

- The offset/gain value is written when the "offset/gain writing enable code" is set to "E210H".
- The offset/gain value can be written only while D/A conversion is disabled.
- The "D/A conversion enable/disable setting" cannot be changed to "enable" while the offset/gain value is being written.

37

### ■ Offset/gain reading

For reading the offset/gain data saved in the built-in memory of the analog adapter, set the "offset/gain reading" from OFF to ON to read the "output range setting", "offset setting value" and "gain setting value" from the built-in memory of the analog adapter.

When the output range setting during reading is the same as the output range setting in the built-in memory of the analog adapter, the read values are set to the "offset setting value" and "gain setting value". If the output range setting is different, the initial value of the output range setting selected during reading is valid and set to the "offset setting value" and "gain setting value". In this case, the offset/gain setting input range mismatch alarm occurs (Alarm code: 0C0□H)

## Setting procedure

Access to the offset/gain setting window in the GX Works3 to set the offset and gain values.

The setting procedure for the offset/gain setting of the FX5-4A-ADP is as follows:

 [Tool] ⇒ [Module Tool List]

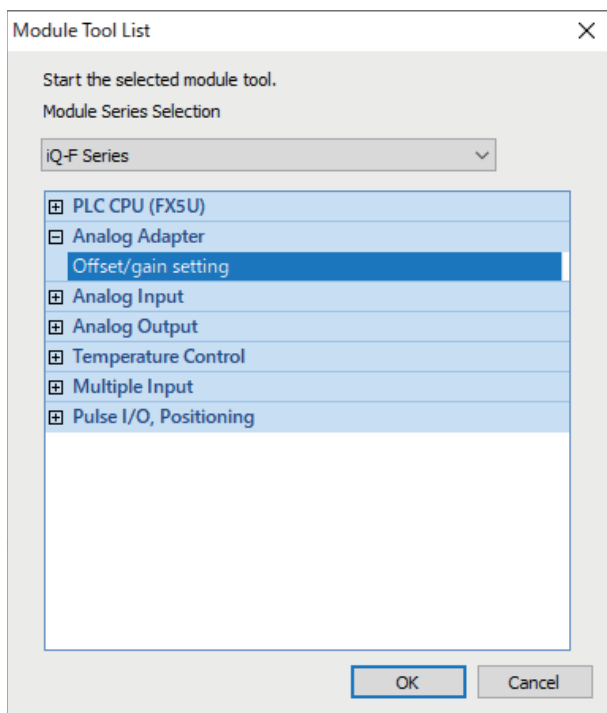

1. In "Analog Adapter", select "Offset/gain setting" and click [OK] button.

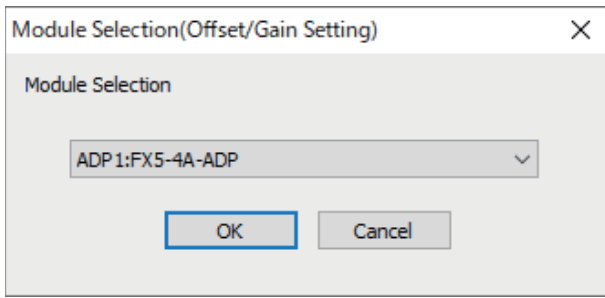

2. Select the target module for the offset/gain setting, and click [OK] button.

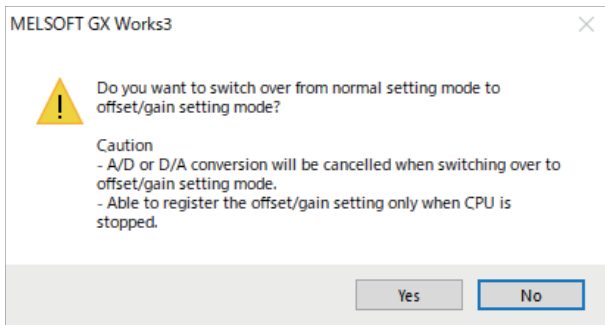

3. Click [Yes] button.

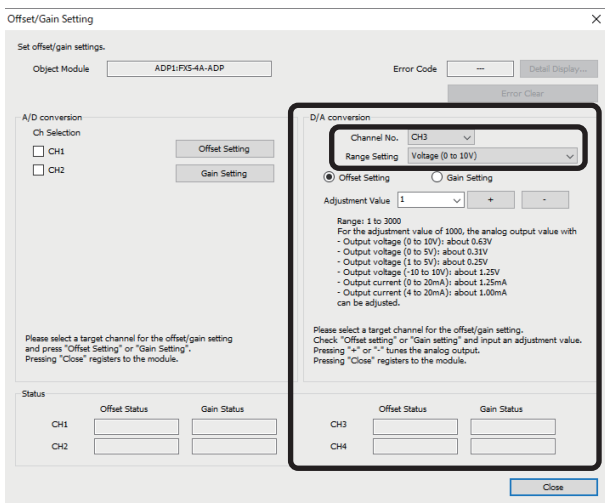

4. Execute the settings in D/A conversion. Specify the channel to configure the offset/gain setting and the user range setting.

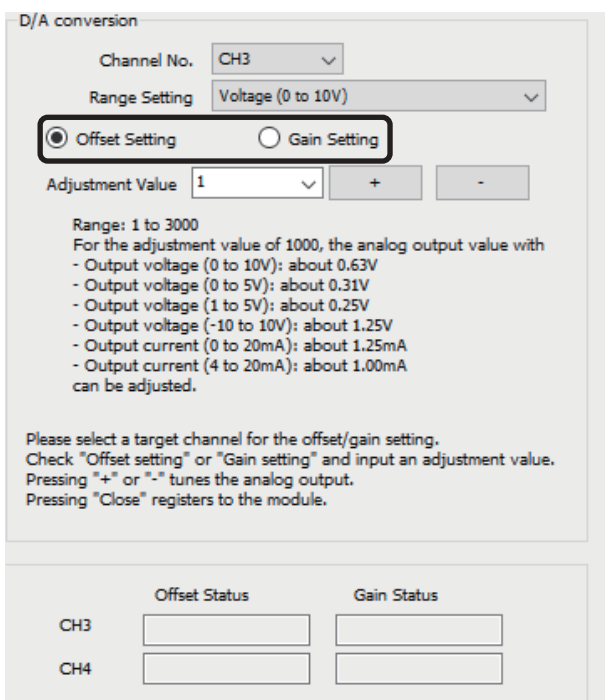

5. Use the radio button to specify whether to perform the offset setting or gain setting. (Step 6 and later steps describe the case where offset setting is specified.)



D/A conversion

Channel No.

Range Setting

Offset Setting  Gain Setting

Adjustment Value

Range: 1 to 3000  
 For the adjustment value of 100, the analog output value with  
 - Output voltage (0 to 10V): about 0.63V  
 - Output voltage (0 to 5V): about 0.31V  
 - Output voltage (1 to 5V): about 0.25V  
 - Output voltage (-10 to 10V): about 1.25V  
 - Output current (0 to 20mA): about 1.25mA  
 - Output current (4 to 20mA): about 1.00mA  
 can be adjusted.

Please select a target channel for the offset/gain setting.  
 Check "Offset setting" or "Gain setting" and input an adjustment value.  
 Pressing "+" or "-" tunes the analog output.  
 Pressing "Close" registers to the module.

	Offset Status	Gain Status
CH3	<input type="text"/>	<input type="text"/>
CH4	<input type="text"/>	<input type="text"/>

D/A conversion

Channel No.

Range Setting

Offset Setting  Gain Setting

Adjustment Value

Range: 1 to 3000  
 For the adjustment value of 1000, the analog output value with  
 - Output voltage (0 to 10V): about 0.63V  
 - Output voltage (0 to 5V): about 0.31V  
 - Output voltage (1 to 5V): about 0.25V  
 - Output voltage (-10 to 10V): about 1.25V  
 - Output current (0 to 20mA): about 1.25mA  
 - Output current (4 to 20mA): about 1.00mA  
 can be adjusted.

Please select a target channel for the offset/gain setting.  
 Check "Offset setting" or "Gain setting" and input an adjustment value.  
 Pressing "+" or "-" tunes the analog output.  
 Pressing "Close" registers to the module.

	Offset Status	Gain Status
CH3	<input type="text" value="Changed"/>	<input type="text"/>
CH4	<input type="text"/>	<input type="text"/>

MELSOFT GX Works3

 Do you want to register the offset/gain setting and exit?  
 The mode will be switched over to normal mode from offset/gain setting mode after ending.

- Click [YES] to end the application after registering.
- Click [NO] to discard the setting.

Caution

- The offset/gain setting is not valid until the registration is executed.
- Unable to register if an error occurs in the target module.
- Able to register the offset/gain setting only when CPU is stopped.

6. The adjustment value of the offset value or gain value can be selected from "1", "100", "500", "1000", "2000", and "3000" or it can be set by inputting any value (1 to 3000).

7. Clicking the [+ (+)] or [- (-)] button fine-tunes the analog output voltage or analog output current value corresponding the set adjustment value.

8. Check that the offset setting status in the selected channel has changed to "Changed".

9. To perform the gain setting, repeat the procedure from step 5.

10. After setting is completed, click the [Close] button.

11. Click the [Yes] button.

## Corresponding devices

The devices which are used by the offset/gain setting function are listed below.

Name	Connection part	Special relay			
		CH1 *1	CH2 *1	CH3	CH4
Offset/gain reading	1st adapter	SM6332	SM6372	SM6412	SM6452
	2nd adapter	SM6692	SM6732	SM6772	SM6812
	3rd adapter	SM7052	SM7092	SM7132	SM7172
	4th adapter	SM7412	SM7452	SM7492	SM7532
Offset/gain writing	1st adapter	SM6333	SM6373	SM6413	SM6453
	2nd adapter	SM6693	SM6733	SM6773	SM6813
	3rd adapter	SM7053	SM7093	SM7133	SM7173
	4th adapter	SM7413	SM7453	SM7493	SM7533
Offset setting value	1st adapter	SD6332	SD6372	SD6412	SD6452
	2nd adapter	SD6692	SD6732	SD6772	SD6812
	3rd adapter	SD7052	SD7092	SD7132	SD7172
	4th adapter	SD7412	SD7452	SD7492	SD7532
Gain setting value	1st adapter	SD6333	SD6373	SD6413	SD6453
	2nd adapter	SD6693	SD6733	SD6773	SD6813
	3rd adapter	SD7053	SD7093	SD7133	SD7173
	4th adapter	SD7413	SD7453	SD7493	SD7533
Offset/gain writing enable code	1st adapter	SD6334	SD6374	SD6414	SD6454
	2nd adapter	SD6694	SD6734	SD6774	SD6814
	3rd adapter	SD7054	SD7094	SD7134	SD7174
	4th adapter	SD7414	SD7454	SD7494	SD7534

\*1 Only used by the FX5-4DA-ADP.

The details of the device used are listed below.

Name	Description	Setting value	Description	Default value	R/W
Offset/gain reading	An offset/gain setting value is read.	0: OFF	Offset/gain reading is not performed.	0: OFF	R/W
		1: ON	Offset/gain reading is performed.		
Offset/gain writing	An offset/gain setting value is written in.	0: OFF	Offset/gain writing is not performed.	0: OFF	R/W
		1: ON	Offset/gain writing is performed.		

Item	Description	Setting range		Default value	R/W
		Voltage input (mV)	Current input (μA)		
Offset setting value	Set the offset data/gain data used in the offset/gain setting function.	-10000 to +9000	0 to 17000	0	R/W
Gain setting value		-9000 to +10000	3000 to 30000	Voltage output: 5000 Current output: 20000	R/W

Name	Description	Range	Default value	R/W
Offset/gain writing enable code	Set the offset/gain writing enable code used for changing the offset/gain.	Offset/gain writing enable: E210H Offset/gain writing disable: Other than E210H	0	R/W

# Offset/gain initialization function

FX5-4A-ADP

FX5-4AD-ADP

FX5-4DA-ADP

FX5-4AD-PT-ADP

FX5-4AD-TC-ADP

This function initializes the offset and gain values in the built-in memory of the analog adapter.  
This function can be set only with special devices.

## Operation

Set E210H to "offset/gain writing enable code" and set the "offset/gain initialization" from OFF to ON to initialize the offset value and gain value saved in the built-in memory of the analog adapter. When initialization is completed, the "offset/gain initialization" automatically turns OFF. Also, the "offset/gain writing enable code" is cleared to 0.

### Point

- Offset/gain initialization is executed when the "offset/gain writing enable code" is set to "E210H".
- Offset/gain initialization is enabled only while D/A conversion is disabled.
- The "D/A conversion enable/disable setting" cannot be changed to "enable" while offset/gain initialization is being executed.

37

## Setting procedure

1. Set "E210H" to the "offset/gain writing enable code".

Setting value	Description	Default value
Other than E210H	Offset/gain writing disable	0
E210H	Offset/gain writing enable	

2. Set the "offset/gain initialization" from OFF to ON.

Setting value	Description	Default value
0: OFF	Offset/gain initialization is not performed.	0: OFF
1: ON	Offset/gain initialization is performed.	

## Corresponding devices

The devices which are used by the offset/gain initialization function are listed below.

Name	Connection part	Special relay			
		CH1*1	CH2*1	CH3	CH4
Offset/gain initialization	1st adapter	SM6334	SM6374	SM6414	SM6454
	2nd adapter	SM6694	SM6734	SM6774	SM6814
	3rd adapter	SM7054	SM7094	SM7134	SM7174
	4th adapter	SM7414	SM7454	SM7494	SM7534
Offset/gain writing enable code	1st adapter	SD6334	SD6374	SD6414	SD6454
	2nd adapter	SD6694	SD6734	SD6774	SD6814
	3rd adapter	SD7054	SD7094	SD7134	SD7174
	4th adapter	SD7414	SD7454	SD7494	SD7534

\*1 Only used by the FX5-4DA-ADP.

The details of the device used are listed below.

Name	Description	Setting value	Description	Default value	R/W
Offset/gain initialization	An offset/gain setting value is initialized.	0: OFF	Offset/gain initialization is not performed.	0: OFF	R/W
		1: ON	Offset/gain initialization is performed.		
Name	Description	Range		Default value	R/W
Offset/gain writing enable code	Set the offset/gain writing enable code used for changing the offset/gain.	Offset/gain writing enable: E210H Offset/gain writing disable: Other than E210H		0	R/W

# Analog output test when CPU module is in STOP status function

FX5-4A-ADP

FX5-4AD-ADP

FX5-4DA-ADP

FX5-4AD-PT-ADP

FX5-4AD-TC-ADP

Analog output tests can be carried out when the CPU module is in the STOP status.

The following functions are enabled during the analog output test.

- Scaling function ( [Page 709 Scaling function](#) )
- Shift function ( [Page 705 Shift function](#) )
- Warning output function ( [Page 707 Warning output function](#) )

## Operation

When the "D/A conversion enable/disable setting" is set from ON to OFF and the "D/A output enable/disable setting" is set from ON to OFF, the analog output test is started and analog output is given.

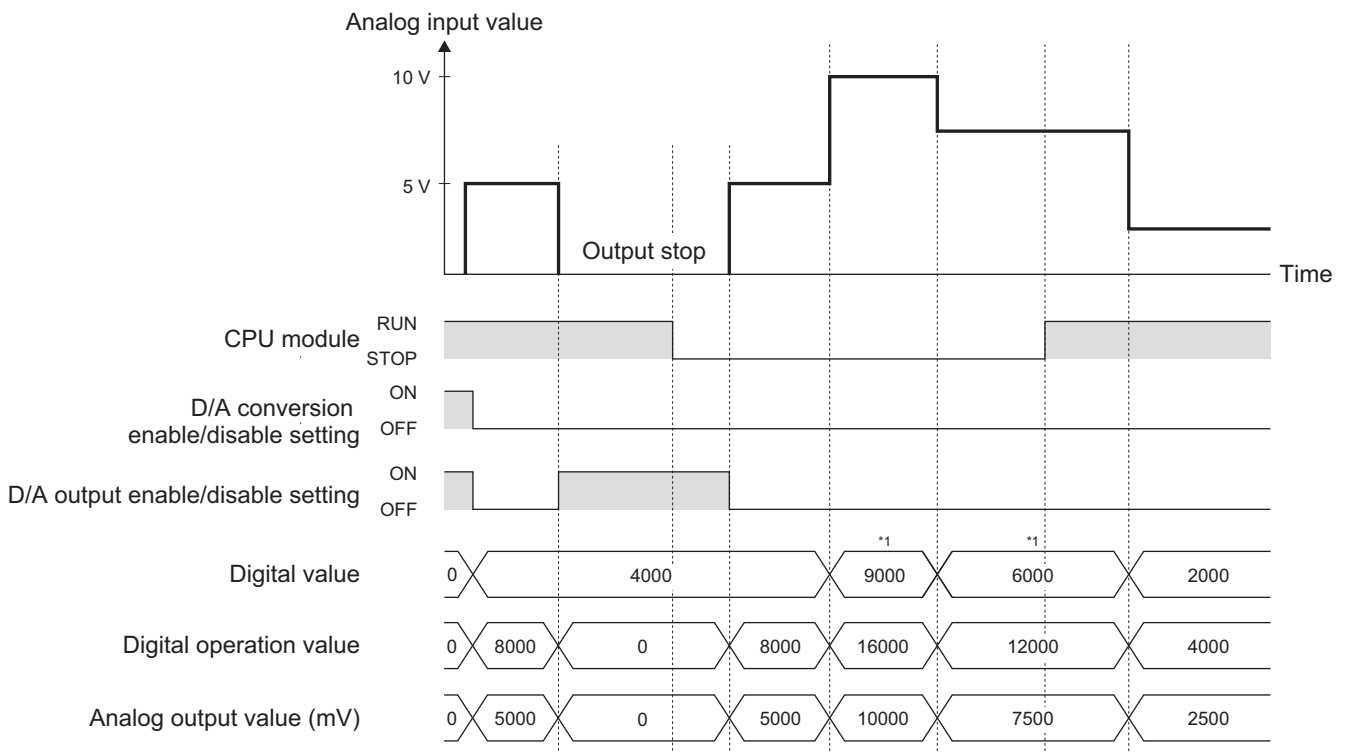

## Setting methods

To perform an analog output test, configure the settings in the device test of the GX Works3 following the procedure shown below.

1. Set the digital value corresponding to the desired analog value to output in "digital value".
2. Set "D/A conversion enable/disable setting" to OFF (Enable D/A conversion).
3. Set "D/A output enable/disable setting" to OFF (Enable D/A output).

## Corresponding devices

The devices that are used by the analog output test function when the CPU module is stopped are listed below.

Name	Connection part	Special register			
		CH1 <sup>*1</sup>	CH2 <sup>*1</sup>	CH3	CH4
D/A conversion enable/disable setting	1st adapter	SM6300	SM6340	SM6380	SM6420
	2nd adapter	SM6660	SM6700	SM6740	SM6780
	3rd adapter	SM7020	SM7060	SM7100	SM7140
	4th adapter	SM7380	SM7420	SM7460	SM7500
D/A output enable/disable setting	1st adapter	SM6301	SM6341	SM6381	SM6421
	2nd adapter	SM6661	SM6701	SM6741	SM6781
	3rd adapter	SM7021	SM7061	SM7101	SM7141
	4th adapter	SM7381	SM7421	SM7461	SM7501
Digital value	1st adapter	SD6300	SD6340	SD6380	SD6420
	2nd adapter	SD6660	SD6700	SD6740	SD6780
	3rd adapter	SD7020	SD7060	SD7100	SD7140
	4th adapter	SD7380	SD7420	SD7460	SD7500

\*1 Only used by the FX5-4DA-ADP.

The details of the device used are listed below.

Name	Description	Setting value	Description	Default value	R/W
D/A conversion enable/disable setting	Set whether to enable or disable D/A conversion.	0: OFF	D/A conversion enable	1: ON	R/W
		1: ON	D/A conversion disable		
D/A output enable/disable setting	Set whether to output the D/A conversion value or to output the offset value. The setting value will be ignored when the D/A conversion enable/disable setting is set to "disable".	0: OFF	D/A conversion value	1: ON	R/W
		1: ON	Offset value		

Name	Description	Output range setting	Digital input range	When the scaling function is enabled	Default value	R/W
Digital value	Set the digital value for D/A conversion. When the digital value is set outside the allowable setting range, D/A conversion will be executed within the allowable setting range.	Voltage	0 to 10V	0 to 16000	Scaling lower limit value to Scaling upper limit value	1: ON
			0 to 5V	0 to 16000		
			1 to 5V	0 to 16000		
			-10 to +10V	-8000 to +8000		
		Current	0 to 20mA	0 to 16000		
			4 to 20mA	0 to 16000		

## 37.8 Functions (Temperature Sensor Input)

This section describes details of the functions and how to set them using the GX Works3.

### Conversion enable/disable setting function

FX5-4A-ADP

FX5-4AD-ADP

FX5-4DA-ADP

FX5-4AD-PT-ADP

FX5-4AD-TC-ADP

This function sets whether to enable or disable the temperature conversion for each channel. Disabling the conversion on unused channels reduces the conversion cycles.

#### Operation

The analog input is temperature converted only in the channels for which the "conversion enable/disable setting" is set to "enable", and values are stored in the "measured temperature value". Changing "conversion enable/disable setting" from "enable" to "disable" clears the following.

- "Conversion completed flag"
- "Warning output flag (process alarm upper limit)"
- "Warning output flag (process alarm lower limit)"
- "Warning output flag (rate alarm upper limit)"
- "Warning output flag (rate alarm lower limit)"
- "Disconnection detection flag"
- "Measured temperature value"
- "Maximum value"
- "Minimum value"

#### Setting procedure

Set "Conversion enable/disable setting" to "conversion enable".

Navigation window ⇒ [Parameter] ⇒ [Module Information] ⇒ Module model name ⇒ [Module Parameter] ⇒ "Basic Settings" ⇒ "Conversion enable/disable setting"

#### Corresponding devices

The devices which are used by the conversion enable/disable setting function are listed below.

Name	Connection part	Special relay			
		CH1	CH2	CH3	CH4
Conversion enable/disable setting	1st adapter	SM6301	SM6341	SM6381	SM6421
	2nd adapter	SM6661	SM6701	SM6741	SM6781
	3rd adapter	SM7021	SM7061	SM7101	SM7141
	4th adapter	SM7381	SM7421	SM7461	SM7501

The details of the device used are listed below.

Name	Description	Setting value	Description	Default value	R/W
Conversion enable/disable setting	Set whether to enable or disable temperature conversion.	0: OFF	Temperature conversion enable	1: ON	R/W
		1: ON	Temperature conversion disable		

# Temperature resistance choice function



This function sets a resistance temperature detector type for each channel.

Selecting the resistance temperature detector type sets the input conversion characteristics.

## Operation

A resistance temperature detector is switched when the "conversion enable/disable setting" is "disable" and "setting RTD type" has been changed.

When the resistance temperature detector is switched, the following special devices are initialized:

Name	Connection part	Special device			
		CH1	CH2	CH3	CH4
Conversion completed flag	1st adapter	SM6300	SM6340	SM6380	SM6420
	2nd adapter	SM6660	SM6700	SM6740	SM6780
	3rd adapter	SM7020	SM7060	SM7100	SM7140
	4th adapter	SM7380	SM7420	SM7460	SM7500
Warning output flag (process alarm upper limit)	1st adapter	SM6311	SM6351	SM6391	SM6431
	2nd adapter	SM6671	SM6711	SM6751	SM6791
	3rd adapter	SM7031	SM7071	SM7111	SM7151
	4th adapter	SM7391	SM7431	SM7471	SM7511
Warning output flag (process alarm lower limit)	1st adapter	SM6312	SM6352	SM6392	SM6432
	2nd adapter	SM6672	SM6712	SM6752	SM6792
	3rd adapter	SM7032	SM7072	SM7112	SM7152
	4th adapter	SM7392	SM7432	SM7472	SM7512
Warning output flag (rate alarm upper limit)	1st adapter	SM6315	SM6355	SM6395	SM6435
	2nd adapter	SM6675	SM6715	SM6755	SM6795
	3rd adapter	SM7035	SM7075	SM7115	SM7155
	4th adapter	SM7395	SM7435	SM7475	SM7515
Warning output flag (rate alarm lower)	1st adapter	SM6316	SM6356	SM6396	SM6436
	2nd adapter	SM6676	SM6716	SM6756	SM6796
	3rd adapter	SM7036	SM7076	SM7116	SM7156
	4th adapter	SM7396	SM7436	SM7476	SM7516
Disconnection detection flag	1st adapter	SM6318	SM6358	SM6398	SM6438
	2nd adapter	SM6678	SM6718	SM6758	SM6798
	3rd adapter	SM7038	SM7078	SM7118	SM7158
	4th adapter	SM7398	SM7438	SM7478	SM7518
Offset/gain setting flag	1st adapter	SM6331	SM6371	SM6411	SM6451
	2nd adapter	SM6691	SM6731	SM6771	SM6811
	3rd adapter	SM7051	SM7091	SM7131	SM7171
	4th adapter	SM7411	SM7451	SM7491	SM7531
Measured temperature value	1st adapter	SD6300	SD6340	SD6380	SD6420
	2nd adapter	SD6660	SD6700	SD6740	SD6780
	3rd adapter	SD7020	SD7060	SD7100	SD7140
	4th adapter	SD7380	SD7420	SD7460	SD7500
Maximum value	1st adapter	SD6306	SD6346	SD6386	SD6426
	2nd adapter	SD6666	SD6706	SD6746	SD6786
	3rd adapter	SD7026	SD7066	SD7106	SD7146
	4th adapter	SD7386	SD7426	SD7466	SD7506

Name	Connection part	Special device			
		CH1	CH2	CH3	CH4
Minimum value	1st adapter	SD6307	SD6347	SD6387	SD6427
	2nd adapter	SD6667	SD6707	SD6747	SD6787
	3rd adapter	SD7027	SD7067	SD7107	SD7147
	4th adapter	SD7387	SD7427	SD7467	SD7507
Offset temperature setting value <sup>*1</sup>	1st adapter	SD6327	SD6367	SD6407	SD6447
	2nd adapter	SD6687	SD6727	SD6767	SD6807
	3rd adapter	SD7047	SD7087	SD7127	SD7167
	4th adapter	SD7407	SD7447	SD7487	SD7527
Gain temperature setting value <sup>*1</sup>	1st adapter	SD6328	SD6368	SD6408	SD6448
	2nd adapter	SD6688	SD6728	SD6768	SD6808
	3rd adapter	SD7048	SD7088	SD7128	SD7168
	4th adapter	SD7408	SD7448	SD7488	SD7528
Resistance offset value (L) <sup>*1</sup>	1st adapter	SD6330	SD6370	SD6410	SD6450
	2nd adapter	SD6690	SD6730	SD6770	SD6810
	3rd adapter	SD7050	SD7090	SD7130	SD7170
	4th adapter	SD7410	SD7450	SD7490	SD7530
Resistance offset value (H) <sup>*1</sup>	1st adapter	SD6331	SD6371	SD6411	SD6451
	2nd adapter	SD6691	SD6731	SD6771	SD6811
	3rd adapter	SD7051	SD7091	SD7131	SD7171
	4th adapter	SD7411	SD7451	SD7491	SD7531
Resistance gain value (L) <sup>*1</sup>	1st adapter	SD6332	SD6372	SD6412	SD6452
	2nd adapter	SD6692	SD6732	SD6772	SD6812
	3rd adapter	SD7052	SD7092	SD7132	SD7172
	4th adapter	SD7412	SD7452	SD7492	SD7532
Resistance gain value (H) <sup>*1</sup>	1st adapter	SD6333	SD6373	SD6413	SD6453
	2nd adapter	SD6693	SD6733	SD6773	SD6813
	3rd adapter	SD7053	SD7093	SD7133	SD7173
	4th adapter	SD7413	SD7453	SD7493	SD7533
Input offset value (L) <sup>*1</sup>	1st adapter	SD6334	SD6374	SD6414	SD6454
	2nd adapter	SD6694	SD6734	SD6774	SD6814
	3rd adapter	SD7054	SD7094	SD7134	SD7174
	4th adapter	SD7414	SD7454	SD7494	SD7534
Input offset value (H) <sup>*1</sup>	1st adapter	SD6335	SD6375	SD6415	SD6455
	2nd adapter	SD6695	SD6735	SD6775	SD6815
	3rd adapter	SD7055	SD7095	SD7135	SD7175
	4th adapter	SD7415	SD7455	SD7495	SD7535
Input gain value (L) <sup>*1</sup>	1st adapter	SD6336	SD6376	SD6416	SD6456
	2nd adapter	SD6696	SD6736	SD6776	SD6816
	3rd adapter	SD7056	SD7096	SD7136	SD7176
	4th adapter	SD7416	SD7456	SD7496	SD7536
Input gain value (H) <sup>*1</sup>	1st adapter	SD6337	SD6377	SD6417	SD6457
	2nd adapter	SD6697	SD6737	SD6777	SD6817
	3rd adapter	SD7057	SD7097	SD7137	SD7177
	4th adapter	SD7417	SD7457	SD7497	SD7537

\*1 If the changed RTD is equal to the RTD set using the offset/gain setting function, the value set using the offset/gain setting function (user range setting) will be reflected. In any other case, the value is initialized to the initial value.



## Setting procedure

Set "Resistance temperature detector type setting" to a desired resistance temperature detector.

Navigation window ⇒ [Parameter] ⇒ [Module Information] ⇒ Module model name ⇒ [Module Parameter] ⇒ "Basic Settings" ⇒ "Resistance temperature detector type selection function"

Item	Temperature unit	Temperature input range	Input characteristics (measured temperature value)
Pt100	Celsius (°C)	-200 to +850°C	-2000 to +8500
	Fahrenheit (°F)	-328 to +1562°F	-3280 to +15620
Ni100	Celsius (°C)	-60 to +250°C	-600 to +2500
	Fahrenheit (°F)	-76 to +482°F	-760 to +4820

## Corresponding devices

The devices which are used by the temperature resistance choice function are listed below.

Name	Connection part	Special register			
		CH1	CH2	CH3	CH4
Resistance temperature detector type setting	1st adapter	SD6305	SD6345	SD6385	SD6425
	2nd adapter	SD6665	SD6705	SD6745	SD6785
	3rd adapter	SD7025	SD7065	SD7105	SD7145
	4th adapter	SD7385	SD7425	SD7465	SD7505

The details of the device used are listed below.

Name	Description	Setting value	Description	Default value	R/W
Resistance temperature detector type setting	Set the RTD type. If a value other than the setting value is set, the range setting/RTD type range error (error code: 1A8□H) occurs, and the temperature conversion cannot be performed.	0	Pt100	0	R/W
		1	Ni100		

## Thermocouple type choice function



This function sets a thermocouple type for each channel.

Selecting the thermocouple type sets the input conversion characteristics.

## Operation

Thermocouple type is switched when the "conversion enable/disable setting" is "disable" and "thermocouple type setting" has been changed.

When the thermocouple type is switched, the following special devices are initialized:

Name	Connection part	Special device			
		CH1	CH2	CH3	CH4
Conversion completed flag	1st adapter	SM6300	SM6340	SM6380	SM6420
	2nd adapter	SM6660	SM6700	SM6740	SM6780
	3rd adapter	SM7020	SM7060	SM7100	SM7140
	4th adapter	SM7380	SM7420	SM7460	SM7500
Warning output flag (process alarm upper limit)	1st adapter	SM6311	SM6351	SM6391	SM6431
	2nd adapter	SM6671	SM6711	SM6751	SM6791
	3rd adapter	SM7031	SM7071	SM7111	SM7151
	4th adapter	SM7391	SM7431	SM7471	SM7511

Name	Connection part	Special device			
		CH1	CH2	CH3	CH4
Warning output flag (process alarm lower limit)	1st adapter	SM6312	SM6352	SM6392	SM6432
	2nd adapter	SM6672	SM6712	SM6752	SM6792
	3rd adapter	SM7032	SM7072	SM7112	SM7152
	4th adapter	SM7392	SM7432	SM7472	SM7512
Warning output flag (rate alarm upper limit)	1st adapter	SM6315	SM6355	SM6395	SM6435
	2nd adapter	SM6675	SM6715	SM6755	SM6795
	3rd adapter	SM7035	SM7075	SM7115	SM7155
	4th adapter	SM7395	SM7435	SM7475	SM7515
Warning output flag (rate alarm lower)	1st adapter	SM6316	SM6356	SM6396	SM6436
	2nd adapter	SM6676	SM6716	SM6756	SM6796
	3rd adapter	SM7036	SM7076	SM7116	SM7156
	4th adapter	SM7396	SM7436	SM7476	SM7516
Disconnection detection flag	1st adapter	SM6318	SM6358	SM6398	SM6438
	2nd adapter	SM6678	SM6718	SM6758	SM6798
	3rd adapter	SM7038	SM7078	SM7118	SM7158
	4th adapter	SM7398	SM7438	SM7478	SM7518
Offset/gain setting flag	1st adapter	SM6331	SM6371	SM6411	SM6451
	2nd adapter	SM6691	SM6731	SM6771	SM6811
	3rd adapter	SM7051	SM7091	SM7131	SM7171
	4th adapter	SM7411	SM7451	SM7491	SM7531
Measured temperature value	1st adapter	SD6300	SD6340	SD6380	SD6420
	2nd adapter	SD6660	SD6700	SD6740	SD6780
	3rd adapter	SD7020	SD7060	SD7100	SD7140
	4th adapter	SD7380	SD7420	SD7460	SD7500
Maximum value	1st adapter	SD6306	SD6346	SD6386	SD6426
	2nd adapter	SD6666	SD6706	SD6746	SD6786
	3rd adapter	SD7026	SD7066	SD7106	SD7146
	4th adapter	SD7386	SD7426	SD7466	SD7506
Minimum value	1st adapter	SD6307	SD6347	SD6387	SD6427
	2nd adapter	SD6667	SD6707	SD6747	SD6787
	3rd adapter	SD7027	SD7067	SD7107	SD7147
	4th adapter	SD7387	SD7427	SD7467	SD7507
Offset temperature setting value <sup>*1</sup>	1st adapter	SD6327	SD6367	SD6407	SD6447
	2nd adapter	SD6687	SD6727	SD6767	SD6807
	3rd adapter	SD7047	SD7087	SD7127	SD7167
	4th adapter	SD7407	SD7447	SD7487	SD7527
Gain temperature setting value <sup>*1</sup>	1st adapter	SD6328	SD6368	SD6408	SD6448
	2nd adapter	SD6688	SD6728	SD6768	SD6808
	3rd adapter	SD7048	SD7088	SD7128	SD7168
	4th adapter	SD7408	SD7448	SD7488	SD7528
Thermal EMF offset value (L) <sup>*1</sup>	1st adapter	SD6330	SD6370	SD6410	SD6450
	2nd adapter	SD6690	SD6730	SD6770	SD6810
	3rd adapter	SD7050	SD7090	SD7130	SD7170
	4th adapter	SD7410	SD7450	SD7490	SD7530
Thermal EMF offset value (H) <sup>*1</sup>	1st adapter	SD6331	SD6371	SD6411	SD6451
	2nd adapter	SD6691	SD6731	SD6771	SD6811
	3rd adapter	SD7051	SD7091	SD7131	SD7171
	4th adapter	SD7411	SD7451	SD7491	SD7531
Thermal EMF gain value (L) <sup>*1</sup>	1st adapter	SD6332	SD6372	SD6412	SD6452
	2nd adapter	SD6692	SD6732	SD6772	SD6812
	3rd adapter	SD7052	SD7092	SD7132	SD7172
	4th adapter	SD7412	SD7452	SD7492	SD7532

Name	Connection part	Special device			
		CH1	CH2	CH3	CH4
Thermal EMF gain value (H) <sup>*1</sup>	1st adapter	SD6333	SD6373	SD6413	SD6453
	2nd adapter	SD6693	SD6733	SD6773	SD6813
	3rd adapter	SD7053	SD7093	SD7133	SD7173
	4th adapter	SD7413	SD7453	SD7493	SD7533
Input offset value (L) <sup>*1</sup>	1st adapter	SD6334	SD6374	SD6414	SD6454
	2nd adapter	SD6694	SD6734	SD6774	SD6814
	3rd adapter	SD7054	SD7094	SD7134	SD7174
	4th adapter	SD7414	SD7454	SD7494	SD7534
Input offset value (H) <sup>*1</sup>	1st adapter	SD6335	SD6375	SD6415	SD6455
	2nd adapter	SD6695	SD6735	SD6775	SD6815
	3rd adapter	SD7055	SD7095	SD7135	SD7175
	4th adapter	SD7415	SD7455	SD7495	SD7535
Input gain value (L) <sup>*1</sup>	1st adapter	SD6336	SD6376	SD6416	SD6456
	2nd adapter	SD6696	SD6736	SD6776	SD6816
	3rd adapter	SD7056	SD7096	SD7136	SD7176
	4th adapter	SD7416	SD7456	SD7496	SD7536
Input gain value (H) <sup>*1</sup>	1st adapter	SD6337	SD6377	SD6417	SD6457
	2nd adapter	SD6697	SD6737	SD6777	SD6817
	3rd adapter	SD7057	SD7097	SD7137	SD7177
	4th adapter	SD7417	SD7457	SD7497	SD7537

\*1 If the changed thermocouple is equal to the thermocouple set using the offset/gain setting function, the value set using the offset/gain setting function (user range setting) will be reflected. In any other case, the value is initialized to the initial value.

## Setting procedure

Set "Thermocouple type setting" to the desired thermocouple.

Navigation window ⇒ [Parameter] ⇒ [Module Information] ⇒ Module model name ⇒ [Module Parameter] ⇒ "Basic Settings" ⇒ "Thermocouple type selection function"

Item	Temperature unit	Temperature input range	Input characteristics (measured temperature value)
K	Celsius (°C)	-270 to +1370°C	-2700 to +13700
	Fahrenheit (°F)	-454 to +2498°F	-4540 to +24980
J	Celsius (°C)	-210 to +1130°C	-2100 to +11300
	Fahrenheit (°F)	-346 to +2066°F	-3460 to +20660
T	Celsius (°C)	-270 to +400°C	-2700 to +4000
	Fahrenheit (°F)	-454 to +752°F	-4540 to +7520
B	Celsius (°C)	0 to 1710°C	0 to 17100
	Fahrenheit (°F)	32 to 3110°F	320 to 31100
R	Celsius (°C)	-50 to +1710°C	-500 to +17100
	Fahrenheit (°F)	-58 to +3110°F	-580 to +31100
S	Celsius (°C)	-50 to +1710°C	-500 to +17100
	Fahrenheit (°F)	-58 to +3110°F	-580 to +31100

## Corresponding devices

The devices which are used by the thermocouple type choice function are listed below.

Name	Connection part	Special relay			
		CH1	CH2	CH3	CH4
Setting thermocouple type	1st adapter	SD6305	SD6345	SD6385	SD6425
	2nd adapter	SD6665	SD6705	SD6745	SD6785
	3rd adapter	SD7025	SD7065	SD7105	SD7145
	4th adapter	SD7385	SD7425	SD7465	SD7505

The details of the device used are listed below.

Name	Description	Setting value	Description	Default value	R/W
Thermocouple type setting	Set the thermocouple type. If a value other than the setting value is set, the range setting/RTD type setting/thermocouple type range error (error code: 1A8□H) occurs, and the temperature conversion cannot be performed.	0	K thermocouple	0	R/W
		1	J thermocouple		
		2	T thermocouple		
		3	B thermocouple		
		4	R thermocouple		
		5	S thermocouple		

## Disconnection detection function



Simple disconnection detection is performed.

### Precautions

The disconnection detection function operates according to the user environment, and thus the detection value varies depending on the difference of wiring resistance.

## Operation

### ■Operations at disconnection

When the analog (temperature) input value reaches the disconnection detection condition in a channel for which the "conversion enable/disable setting" is set to enable and the "disconnection detection enable/disable setting" is set to "enable", the situation is regarded as disconnection. As a result, an alarm occurs and the "disconnection detection flag" turns ON. (Alarm code: 0A0□H)

If disconnection is detected, the temperature conversion is interrupted, and a value (upscale, downscale, any value, or value immediately before disconnection) is stored in the "measured temperature value" according to the setting of "conversion setting for disconnection detection".

### Precautions

While the disconnection detection function is operating, the alarm output function (process alarm), alarm output function (rate alarm), maximum value/minimum value hold function do not operate. In addition, when "conversion enable/disable setting" is "enable", the data related to the disconnection detection function cannot be changed.

### ■Operations when the connection is re-established

The operations when the disconnection cause is eliminated and the connection to an external device is re-established vary depending on the setting of "disconnection detection automatic clear enable/disable setting".

- When "enable" is set

When the connection is re-established, "disconnection detection flag" turns off and the temperature conversion is restarted. "conversion alarm flag" and the alarm code stored in "conversion latest alarm code", however, are not cleared. To clear "conversion alarm flag" and the alarm code stored in "latest alarm code" or "conversion latest alarm code", set the "conversion alarm clear request" to OFF, ON, and OFF.

- When "disable" is set

"disconnection detection flag" remains in the state when the disconnection was detected. To return the flag to the normal state, turn on and off "Conversion alarm clear request" after re-establishing connections for all channels.

Note that when "disconnection detection enable/disable setting" is changed to "disable", "disconnection detection flag" turns off.

## Detection cycle

Disconnection detection is executed every sampling cycle.

## Setting procedure

1. Set "Disconnection detection enable/disable setting" to "Enable".

Navigation window ⇒ [Parameter] ⇒ [Module Information] ⇒ Module model name ⇒ [Module Parameter] ⇒ "Application Settings" ⇒ "Disconnection detection function"

2. Set "Enable/Disable setting for disconnection detection automatic clear" to "Enable" or "Disable".

3. Using "Conversion setting for disconnection detection", set what value is to be stored in "Measured temperature value" at the time of the disconnection detection.

Item	Setting range
Conversion setting for disconnection detection	<ul style="list-style-type: none"> <li>Upscale</li> <li>Downscale</li> <li>Any value</li> <li>Value before disconnection</li> </ul>

When "upscale" (upper limit value + 5% of measurement range) and "downscale" (lower limit value - 5% of measurement range) are set, the values stored in "measured temperature value" are as follows.

• FX5-4AD-PT-ADP

RTD	Temperature unit	Downscale	Upscale
Pt100	Celsius (°C)	-2525	9025
	Fahrenheit (°F)	-4225	16565
Ni100	Celsius (°C)	-755	2655
	Fahrenheit (°F)	-1039	5099

• FX5-4AD-TC-ADP

Thermocouple	Temperature unit	Downscale	Upscale
K	Celsius (°C)	-3520	14520
	Fahrenheit (°F)	-6016	26456
J	Celsius (°C)	-2770	11970
	Fahrenheit (°F)	-4666	21866
T	Celsius (°C)	-3035	4335
	Fahrenheit (°F)	-5143	8123
B	Celsius (°C)	-855	17955
	Fahrenheit (°F)	-1219	32639
R	Celsius (°C)	-1380	17980
	Fahrenheit (°F)	-2164	32684
S	Celsius (°C)	-1380	17980
	Fahrenheit (°F)	-2164	32684

4. When "Conversion setting for disconnection detection" is set to "Any value", set "Conversion setting function for disconnection detection".

Item	Setting range
Conversion setting function for disconnection detection	-3276.8 to 3276.7 <sup>*1</sup>

\*1 If the temperature unit is Fahrenheit (°F), set the value in increments of 2 (0.2°F).

## Corresponding devices

The devices which are used by the disconnection detection function are listed below.

Name	Connection part	Special relay			
		CH1	CH2	CH3	CH4
Disconnection detection flag	1st adapter	SM6318	SM6358	SM6398	SM6438
	2nd adapter	SM6678	SM6718	SM6758	SM6798
	3rd adapter	SM7038	SM7078	SM7118	SM7158
	4th adapter	SM7398	SM7438	SM7478	SM7518
Disconnection detection enable/disable setting	1st adapter	SM6319	SM6359	SM6399	SM6439
	2nd adapter	SM6679	SM6719	SM6759	SM6799
	3rd adapter	SM7039	SM7079	SM7119	SM7159
	4th adapter	SM7399	SM7439	SM7479	SM7519
Disconnection detection automatic clear enable/disable setting	1st adapter	SM6320	SM6360	SM6400	SM6440
	2nd adapter	SM6680	SM6720	SM6760	SM6800
	3rd adapter	SM7040	SM7080	SM7120	SM7160
	4th adapter	SM7400	SM7440	SM7480	SM7520
Conversion setting for disconnection detection	1st adapter	SD6318	SD6358	SD6398	SD6438
	2nd adapter	SD6678	SD6718	SD6758	SD6798
	3rd adapter	SD7038	SD7078	SD7118	SD7158
	4th adapter	SD7398	SD7438	SD7478	SD7518
Conversion setting value for disconnection detection	1st adapter	SD6319	SD6359	SD6399	SD6439
	2nd adapter	SD6679	SD6719	SD6759	SD6799
	3rd adapter	SD7039	SD7079	SD7119	SD7159
	4th adapter	SD7399	SD7439	SD7479	SD7519

The details of the device used are listed below.

Name	Description	Monitor value	Display description	Default value	R/W
Disconnection detection flag	This flag monitors the disconnection detection.	0: OFF	Normal	0: OFF	R
		1: ON	Disconnection detection		
Disconnection detection enable/disable setting	Set whether to enable or disable the disconnection detection function.	0: OFF	Disconnection detection enable	0: OFF	R/W
		1: ON	Disconnection detection disable		
Disconnection detection automatic clear enable/disable setting	Set whether to enable or disable the disconnection detection automatic clear.	0: OFF	Disconnection recovery detection enable	1: ON	R/W
		1: ON	Disconnection recovery detection disable		
Conversion setting for disconnection detection	Set the value that is to be stored in the "measured temperature value" when a disconnection is detected. If a value other than the setting value is set, the conversion setting range error with disconnection detection enabled (error code: 1AB□H) occurs, and the temperature conversion cannot be performed.	0	Upscale	1	R/W
		1	Downscale		
		2	Any value		
		3	Value immediately before disconnection		

When upscale (upper limit value + 5% of measurement range) and downscale (lower limit value - 5% of measurement range) are selected, the values stored in "measured temperature value" are as follows.

RTD	Temperature unit	Downscale	Upscale
Pt100	Celsius (°C)	-2525	9025
	Fahrenheit (°F)	-4225	16565
Ni100	Celsius (°C)	-755	2655
	Fahrenheit (°F)	-1039	5099

Thermocouple	Temperature unit	Downscale	Upscale
K	Celsius (°C)	-3520	14520
	Fahrenheit (°F)	-6016	26456
J	Celsius (°C)	-2770	11970
	Fahrenheit (°F)	-4666	21866
T	Celsius (°C)	-3035	4335
	Fahrenheit (°F)	-5143	8123
B	Celsius (°C)	-855	17955
	Fahrenheit (°F)	-1219	32639
R	Celsius (°C)	-1380	17980
	Fahrenheit (°F)	-2164	32684
S	Celsius (°C)	-1380	17980
	Fahrenheit (°F)	-2164	32684

Name	Description	Range	Default value	R/W
Conversion setting value for disconnection detection	Set the value that is to be stored in the "measured temperature value" when "conversion setting for disconnection detection" is set to "any value".	-32768 to +32767 (If the temperature unit is Fahrenheit (°F), set the value in increments of 2 (0.2°F).)	0	R/W

## Temperature conversion method



**FX5-4A-ADP**



**FX5-4AD-ADP**



**FX5-4DA-ADP**

**FX5-4AD-PT-ADP**

**FX5-4AD-TC-ADP**

This function sets a temperature conversion method for each channel.

### Sampling processing

Executes the temperature conversion on the analog input approx. 85 ms/channel, and stores the result in the "measured temperature value" each time.

#### Point

Temperature conversion is executed one channel at a time. The time required to convert one channel is approx. 85 ms. Thus, if the conversion is incomplete during the END process, the "measured temperature value" will not be updated until the conversion is completed. The "measured temperature value" is updated during the END process after the conversion is completed, and then conversion of the next channel will be started within the same END process.

### Averaging processing

The FX5-4AD-PT-ADP performs the averaging processing on measured temperature values for each channel and stores the mean values to the "measured temperature value".

The following three types of averaging processing are provided.

- Time average
- Count average
- Moving average

## ■Time average

Temperature conversion is executed for a set time, the total value is averaged, and values are stored in the "measured temperature value".

The number of times of processing within the set time varies depending on the number of channels for which temperature conversion is enabled.

### Point

If the set time is shorter than the scan time, the averaging processing is not executed, but the sampling value is output. However, only in the first output, the averaged value of the 1st sample and 2nd sample is output.

## ■Count average

Temperature conversion is executed for a set number of times, and the averaged value excluding the maximum value and minimum value is stored in the "measured temperature value".

The time required to store the averaged value obtained by count average in the "measured temperature value" varies depending on the scan time.

### Point

The count average requires a total of at least two values excluding the maximum value and minimum value. Set the number of times to "4" or larger value. Note that only in the first output, sampling values are output until the conversion is executed for a set number of times.

## ■Moving average

The number of moving average processing of the temperature conversion value can be specified, and the average value is digitally output and stored in "measured temperature value".

Because the target range for averaging processing is moved in response to every sampling processing, the latest measured temperature value is constantly obtained.

The following figure shows the moving average processing of when the set number of times to "4".

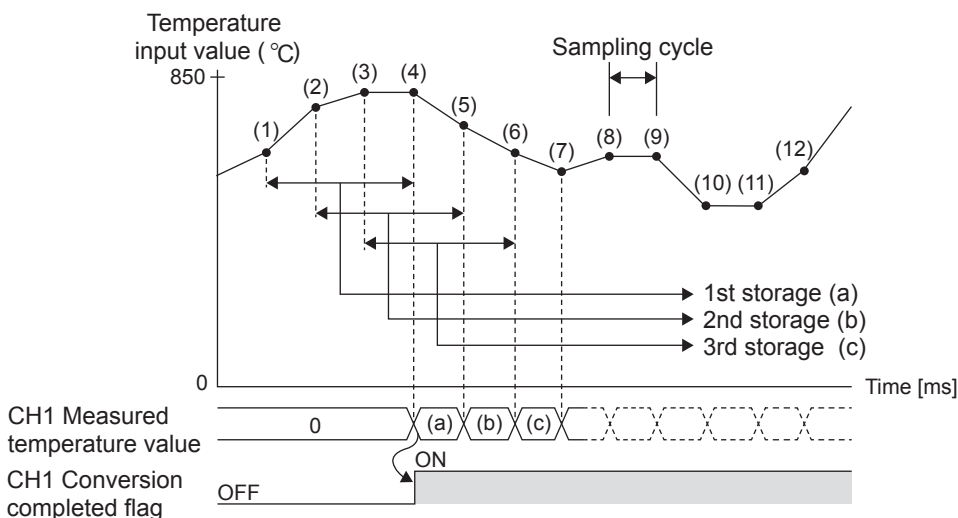

## Setting procedure

### ■Sampling processing

Set "Average Processing Specification" to "Sampling Processing".

Navigation window ⇒ [Parameter] ⇒ [Module Information] ⇒ Module model name ⇒ [Module Parameter] ⇒ "Basic Settings" ⇒ "Temperature Conversion Method"

### ■Averaging processing

1. Set "Average Processing Specification" to "Time Average", "Count Average", or "Moving Average".

Navigation window ⇒ [Parameter] ⇒ [Module Information] ⇒ Module model name ⇒ [Module Parameter] ⇒ "Basic Settings" ⇒ "Temperature Conversion Method"



## 2. Set a value for "Time Average Counts Average Moving Average".

Item	Setting range
Time Average	340 to 10000 (ms)
Count average	4 to 4095 (times)
Moving average	2 to 64 (times)

### Corresponding devices

The devices which are used by the temperature conversion method are listed below.

Name	Connection part	Special register			
		CH1	CH2	CH3	CH4
Measured temperature value	1st adapter	SD6300	SD6340	SD6380	SD6420
	2nd adapter	SD6660	SD6700	SD6740	SD6780
	3rd adapter	SD7020	SD7060	SD7100	SD7140
	4th adapter	SD7380	SD7420	SD7460	SD7500
Average processing setting	1st adapter	SD6303	SD6343	SD6383	SD6423
	2nd adapter	SD6663	SD6703	SD6743	SD6783
	3rd adapter	SD7023	SD7063	SD7103	SD7143
	4th adapter	SD7383	SD7423	SD7463	SD7503
Time Average/Count Average/Moving Average setting	1st adapter	SD6304	SD6344	SD6384	SD6424
	2nd adapter	SD6664	SD6704	SD6744	SD6784
	3rd adapter	SD7024	SD7064	SD7104	SD7144
	4th adapter	SD7384	SD7424	SD7464	SD7504

The details of the device used are listed below.

Name	Description	Range	Default value	R/W
Measured temperature value	The temperature converted digital output value is stored.	-32768 to +32767	0	R

Name	Description	Setting value	Description	Default value	R/W
Average processing setting	Set which one between the sampling processing and the averaging processing is to be selected. The averaging processing is classified into "time average", "count average" and "moving average". If a value other than the setting value is set, the averaging process specification setting range error (error code: 1A0□H) occurs, and temperature conversion cannot be performed.	0	Sampling processing	0	R/W
		1	Time average		
		2	Count average		
		3	Moving average		
Time average/count average/moving average	Set the average time, average counts and moving average counts in the averaging processing for each channel. If a value other than the setting value is set, one of the following will occur and the temperature conversion cannot be performed. <ul style="list-style-type: none"> <li>• Average time setting range error (error code: 1A1□H)</li> <li>• Average count setting range error (error code: 1A2□H)</li> <li>• Moving average count setting range error (error code: 1A3□H)</li> </ul>	340 to 10000 (ms)	Time average	0	R/W
		4 to 4095 (times)	Count average		
		2 to 64 (times)	Moving average		

# Temperature unit choice function



Set whether to use centigrade or fahrenheit as the temperature unit. This setting is for all channels.

## Operation

The "measured temperature value", "maximum value", and "minimum value" are displayed in the temperature unit set by the "temperature unit setting".

The temperature unit can be set only when the "conversion enable/disable setting" is "disable", and the set temperature unit becomes valid after completion of the first temperature conversion.

### Point

- This function is set for each analog adapter.
- After selecting the temperature unit, reset the warning output function and disconnection detection function settings to values that match the temperature unit.

## Precautions

If the "temperature unit setting" is changed while the warning output function or disconnection detection function is used, the setting values for each function will not be recalculated. If the setting values on which the temperature unit has been changed become out of the setting ranges, a range error for each setting is detected. The error detection is performed at the change timing of "conversion enable/disable setting" from "disable" to "enable".

## Setting procedure

Set temperature unit of the "Temperature unit setting".

- FX5-4AD-PT-ADP

Navigation window ⇒ [Parameter] ⇒ [Module Information] ⇒ Module model name ⇒ [Module Parameter] ⇒ "Basic Settings" ⇒ "Temperature unit selection function"

- FX5-4AD-TC-ADP

Navigation window ⇒ [Parameter] ⇒ [Module Information] ⇒ Module model name ⇒ [Module Parameter] ⇒ "Basic Settings" ⇒ "Temperature unit setting"

## Corresponding devices

The devices which are used by the temperature unit choice function are listed below.

Name	Connection part	Special relay			
		CH1	CH2	CH3	CH4
Temperature unit setting	1st adapter	SM6280			
	2nd adapter	SM6640			
	3rd adapter	SM7000			
	4th adapter	SM7360			

Set the desired temperature unit.

Name	Description	Monitor value	Display description	Default value	R/W
Temperature unit setting	Set the desired temperature unit.	0: OFF	Celsius (°C)	0: OFF	R/W
		1: ON	Fahrenheit (°F)		

# Maximum value/minimum value hold function



This function stores the maximum value and minimum value of the measured temperature value to the special registers for each channel.

This function can be set only with special devices.

## Operation

When the "maximum value reset request" or "minimum value reset request" is set from OFF to ON, the maximum value or minimum value of the specified channel is updated to the "measured temperature value" every sampling cycle. In addition, the "maximum value/minimum value reset completed flag" turns ON.

If an RTD or thermocouple is selected, the "maximum value" and "minimum value" are cleared (0).

## Setting procedure

When the "maximum value reset request" or "minimum value reset request" is set from OFF to ON, the maximum value or minimum value is updated.

Setting value	Description	Default value
0: OFF	With no maximum value or minimum value reset request	0: OFF
1: ON	With maximum value or minimum value reset request	

## Corresponding devices

The devices which are used by the maximum value/minimum value hold function are listed below.

Name	Connection part	Special relay			
		CH1	CH2	CH3	CH4
Maximum value/minimum value reset completed flag	1st adapter	SM6305	SM6345	SM6385	SM6425
	2nd adapter	SM6665	SM6705	SM6745	SM6785
	3rd adapter	SM7025	SM7065	SM7105	SM7145
	4th adapter	SM7385	SM7425	SM7465	SM7505
Maximum value reset request	1st adapter	SM6306	SM6346	SM6386	SM6426
	2nd adapter	SM6666	SM6706	SM6746	SM6786
	3rd adapter	SM7026	SM7066	SM7106	SM7146
	4th adapter	SM7386	SM7426	SM7466	SM7506
Minimum value reset request	1st adapter	SM6307	SM6347	SM6387	SM6427
	2nd adapter	SM6667	SM6707	SM6747	SM6787
	3rd adapter	SM7027	SM7067	SM7107	SM7147
	4th adapter	SM7387	SM7427	SM7467	SM7507
Maximum value	1st adapter	SD6306	SD6346	SD6386	SD6426
	2nd adapter	SD6666	SD6706	SD6746	SD6786
	3rd adapter	SD7026	SD7066	SD7106	SD7146
	4th adapter	SD7386	SD7426	SD7466	SD7506
Minimum value	1st adapter	SD6307	SD6347	SD6387	SD6427
	2nd adapter	SD6667	SD6707	SD6747	SD6787
	3rd adapter	SD7027	SD7067	SD7107	SD7147
	4th adapter	SD7387	SD7427	SD7467	SD7507

The details of the device used are listed below.

Name	Description	Monitor value	Display description	Default value	R/W
Maximum value/minimum value reset completed flag	This flag monitors the "maximum value/minimum value" reset status. When the "maximum value reset request" or "minimum value reset request" is set from OFF to ON and then the value stored in the "maximum value" or "minimum value" is reset, the "maximum value/minimum value reset completion flag" turns ON.	0: OFF	Reset is not completed.	0: OFF	R
		1: ON	Reset is completed.		

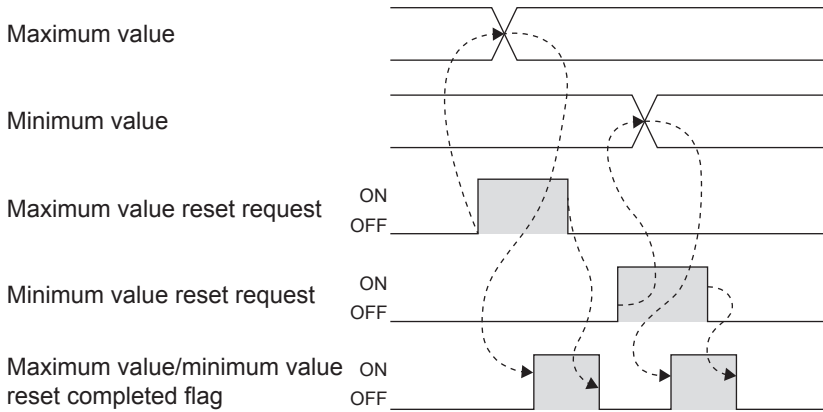

Name	Description	Monitor value	Setting description	Default value	R/W
Maximum value and minimum value reset request	When the "maximum value reset request" and "minimum value reset request" are set from OFF to ON, the maximum value and minimum value are updated to the "measured temperature value".	0: OFF	With no maximum value and minimum value reset request	0: OFF	R/W
		1: ON	With maximum value and minimum value reset request		

Name	Description	Range	Default value	R/W
Maximum value and minimum value	The maximum and minimum values of the measured temperature value are stored. When the "maximum value reset request" and "minimum value reset request" are set from OFF to ON, the maximum value and minimum value of the channel are updated to "measured temperature value".	-32768 to +32767	0	R

# Warning output function



This section describes process alarms and rate alarms used for the warning output function.

## Process alarm

This function outputs an alarm when a measured temperature value enters the preset alarm output range.

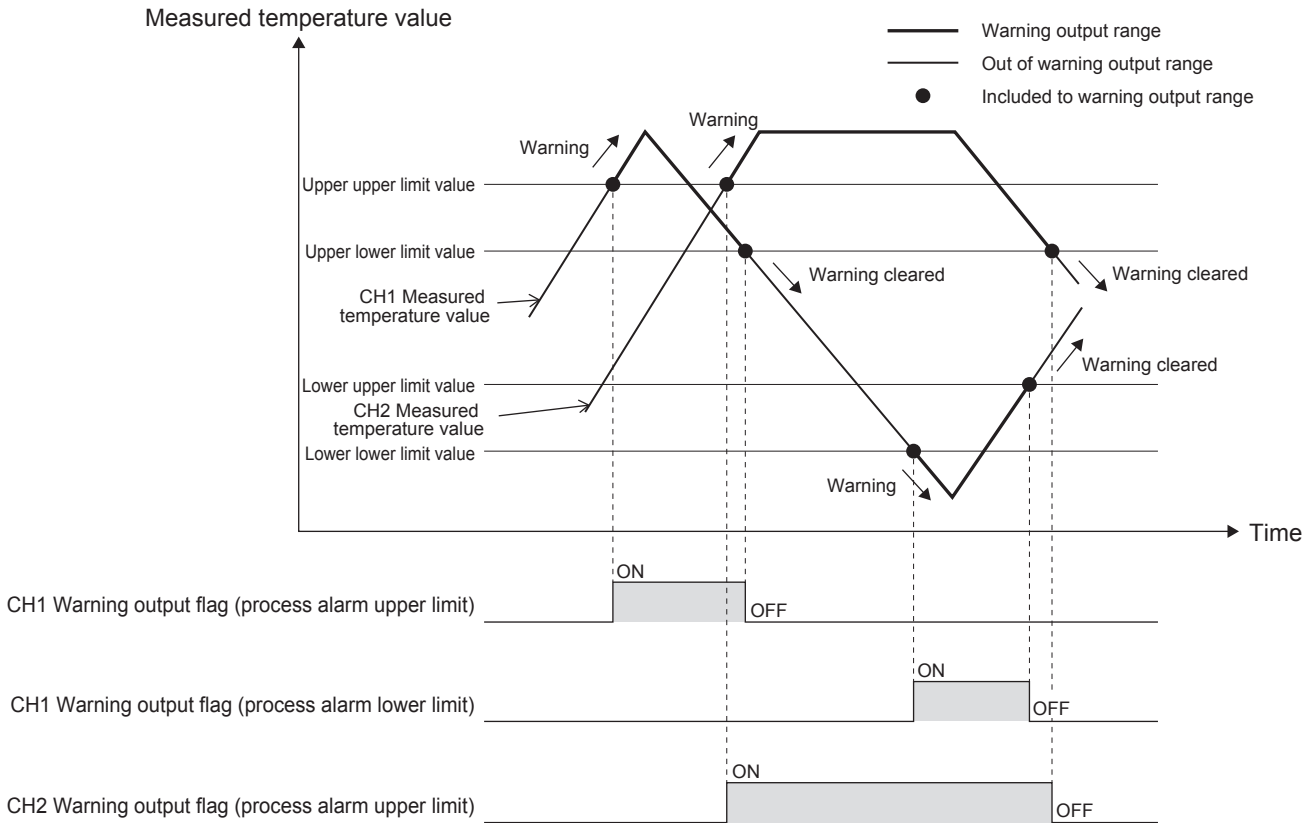

### Operation

If the measured temperature value satisfies the following conditions where a warning is output, the warning output flag corresponding to "conversion alarm flag" turns on.

- The value is equal to or greater than the process alarm upper upper limit value: "Warning output flag (process alarm upper limit)" turns on. (Alarm code: 080□H)
- The value is equal to or smaller than the process alarm lower lower limit value: "Warning output flag (process alarm lower limit)" turns on. (Alarm code: 081□H)

After a warning is output, if the measured temperature value becomes out of the conditions where a warning is output, the corresponding warning output flag turns off.

- The value is smaller than the process alarm upper lower limit value: "Warning output flag (process alarm upper limit)" turns off.
- The value is greater than the process alarm lower upper limit value: "Warning output flag (process alarm lower limit)" turns off.

In addition, when the "warning output setting (process alarm)" is changed to be disabled, "warning output flag (process alarm upper limit)" and "warning output flag (process alarm lower limit)" turn off. "Conversion alarm flag" and the alarm code stored in "conversion latest alarm code", however, are not cleared.

To clear "conversion alarm flag" and the alarm code stored in "conversion latest alarm code", turn on and off "conversion alarm clear request" after all of "warning output flag (process alarm upper limit)" and "warning output flag (process alarm lower limit)" turn off.

## Precautions

When "conversion enable/disable setting" is "enable", the data related to the warning output function (process alarm) cannot be changed.

### ■Detection cycle

The process alarm detection is performed every sampling cycle.

### ■Setting procedure

1. Set "Warning output setting (Process alarm)" to "Enable".

 Navigation window ⇒ [Parameter] ⇒ [Module Information]⇒ Module model name ⇒ [Module Parameter] ⇒ "Application Settings" ⇒ "Warning output function (Process alarm)"

2. Set values for "Process Alarm Upper Upper Limit Value", "Process Alarm Upper Lower Limit Value", "Process Alarm Lower Upper Limit Value", and "Process Alarm Lower Lower Limit Value".

• FX5-4AD-PT-ADP

Item	Resistance temperature detector type setting			Setting range
	Resistance temperature detector	Temperature unit	Temperature input range	
Process Alarm Upper Upper Limit Value Process Alarm Upper Lower Limit Value	Pt100	Celsius (°C)	-200 to +850°C	-2000 to +8500
		Fahrenheit (°F)	-328 to +1562°F	-3280 to +15620 <sup>*1</sup>
Process alarm lower upper limit value Process alarm lower lower limit value	Ni100	Celsius (°C)	-60 to +250°C	-600 to +2500
		Fahrenheit (°F)	-76 to +482°F	-760 to +4820 <sup>*1</sup>

• FX5-4AD-TC-ADP

Item	Setting thermocouple type			Setting range
	Thermocouple	Temperature unit	Temperature input range	
Process Alarm Upper Upper Limit Value Process Alarm Upper Lower Limit Value	K	Celsius (°C)	-270 to +1370°C	-2700 to +13700
		Fahrenheit (°F)	-454 to +2498°F	-4540 to +24980 <sup>*1</sup>
Process alarm lower upper limit value Process alarm lower lower limit value	J	Celsius (°C)	-210 to +1130°C	-2100 to +11300
		Fahrenheit (°F)	-346 to +2066°F	-3460 to +20660 <sup>*1</sup>
	T	Celsius (°C)	-270 to +400°C	-2700 to +4000
		Fahrenheit (°F)	-454 to +752°F	-4540 to +7520 <sup>*1</sup>
	B	Celsius (°C)	0 to 1710°C	0 to 17100
		Fahrenheit (°F)	32 to 3110°F	320 to 31100 <sup>*1</sup>
	R	Celsius (°C)	-50 to +1710°C	-500 to +17100
		Fahrenheit (°F)	-58 to +3110°F	-580 to +31100 <sup>*1</sup>
	S	Celsius (°C)	-50 to +1710°C	-500 to +17100
		Fahrenheit (°F)	-58 to +3110°F	-580 to +31100 <sup>*1</sup>

\*1 Set the value in increments of 2 (0.2°F).

### Point

Set values within the range satisfying the condition "Process Alarm Upper Upper Limit Value ≥ Process Alarm Upper Lower Limit Value ≥ Process Alarm Lower Upper Limit Value ≥ Process Alarm Lower Lower Limit Value".

When not satisfying the above conditions, a process alarm upper lower limit value setting range error occurs. (Error code: 1A4□H)

## ■Corresponding devices

The devices which are used by the process alarm are listed below.

Name	Connection part	Special relay			
		CH1	CH2	CH3	CH4
Warning output flag (process alarm upper limit)	1st adapter	SM6311	SM6351	SM6391	SM6431
	2nd adapter	SM6671	SM6711	SM6751	SM6791
	3rd adapter	SM7031	SM7071	SM7111	SM7151
	4th adapter	SM7391	SM7431	SM7471	SM7511
Warning output flag (process alarm lower limit)	1st adapter	SM6312	SM6352	SM6392	SM6432
	2nd adapter	SM6672	SM6712	SM6752	SM6792
	3rd adapter	SM7032	SM7072	SM7112	SM7152
	4th adapter	SM7392	SM7432	SM7472	SM7512
Warning output setting (process alarm)	1st adapter	SM6313	SM6353	SM6393	SM6433
	2nd adapter	SM6673	SM6713	SM6753	SM6793
	3rd adapter	SM7033	SM7073	SM7113	SM7153
	4th adapter	SM7393	SM7433	SM7473	SM7513
Process alarm upper upper limit value	1st adapter	SD6311	SD6351	SD6391	SD6431
	2nd adapter	SD6671	SD6711	SD6751	SD6791
	3rd adapter	SD7031	SD7071	SD7111	SD7151
	4th adapter	SD7391	SD7431	SD7471	SD7511
Process alarm upper lower limit value	1st adapter	SD6312	SD6352	SD6392	SD6432
	2nd adapter	SD6672	SD6712	SD6752	SD6792
	3rd adapter	SD7032	SD7072	SD7112	SD7152
	4th adapter	SD7392	SD7432	SD7472	SD7512
Process alarm lower upper limit value	1st adapter	SD6313	SD6353	SD6393	SD6433
	2nd adapter	SD6673	SD6713	SD6753	SD6793
	3rd adapter	SD7033	SD7073	SD7113	SD7153
	4th adapter	SD7393	SD7433	SD7473	SD7513
Process alarm lower lower limit value	1st adapter	SD6314	SD6354	SD6394	SD6434
	2nd adapter	SD6674	SD6714	SD6754	SD6794
	3rd adapter	SD7034	SD7074	SD7114	SD7154
	4th adapter	SD7394	SD7434	SD7474	SD7514

The details of the device used are listed below.

Name	Description	Setting value	Description	Default value	R/W
Warning output setting (process alarm)	Set whether to enable or disable the warning output of process alarm.	0: OFF	Warning output of process alarm enable	1: ON	R/W
		1: ON	Warning output of process alarm disable		
Warning output flag (process alarm upper/lower limit)	Monitors the upper limit value warning and lower limit value warning in the process alarm.	0: OFF	Normal	0: OFF	R
		1: ON	Process alarm upper/lower limit detection		

Name	Description	Range	Default value	R/W
Process alarm upper upper limit value Process Alarm Upper Lower Limit Value	Set the value of the warning output function (process alarm). • When changing this device, set process alarm upper upper limit value, process alarm upper lower limit value, process alarm lower upper limit value, and process alarm lower lower limit value within the same scan.	-32768 to +32767 (If the temperature unit is Fahrenheit (°F), set the value in increments of 2 (0.2°F).)	FX5-4AD-PT-ADP • 8500 FX5-4AD-TC-ADP • 12000	R/W
Process alarm lower upper limit value Process alarm lower lower limit value	• If the condition "process alarm upper upper limit value ≥ process alarm upper lower limit value ≥ process alarm lower upper limit value ≥ process alarm lower lower limit value" is not satisfied, the process alarm upper lower limit value setting range error occurs and the temperature conversion cannot be performed. (Error code: 1A4□H)		-2000	R/W

## Rate alarm

This function outputs an alert when the change of a measured temperature value is equal to or greater than the rate alarm upper limit value, or equal to or smaller than the rate alarm lower limit value.

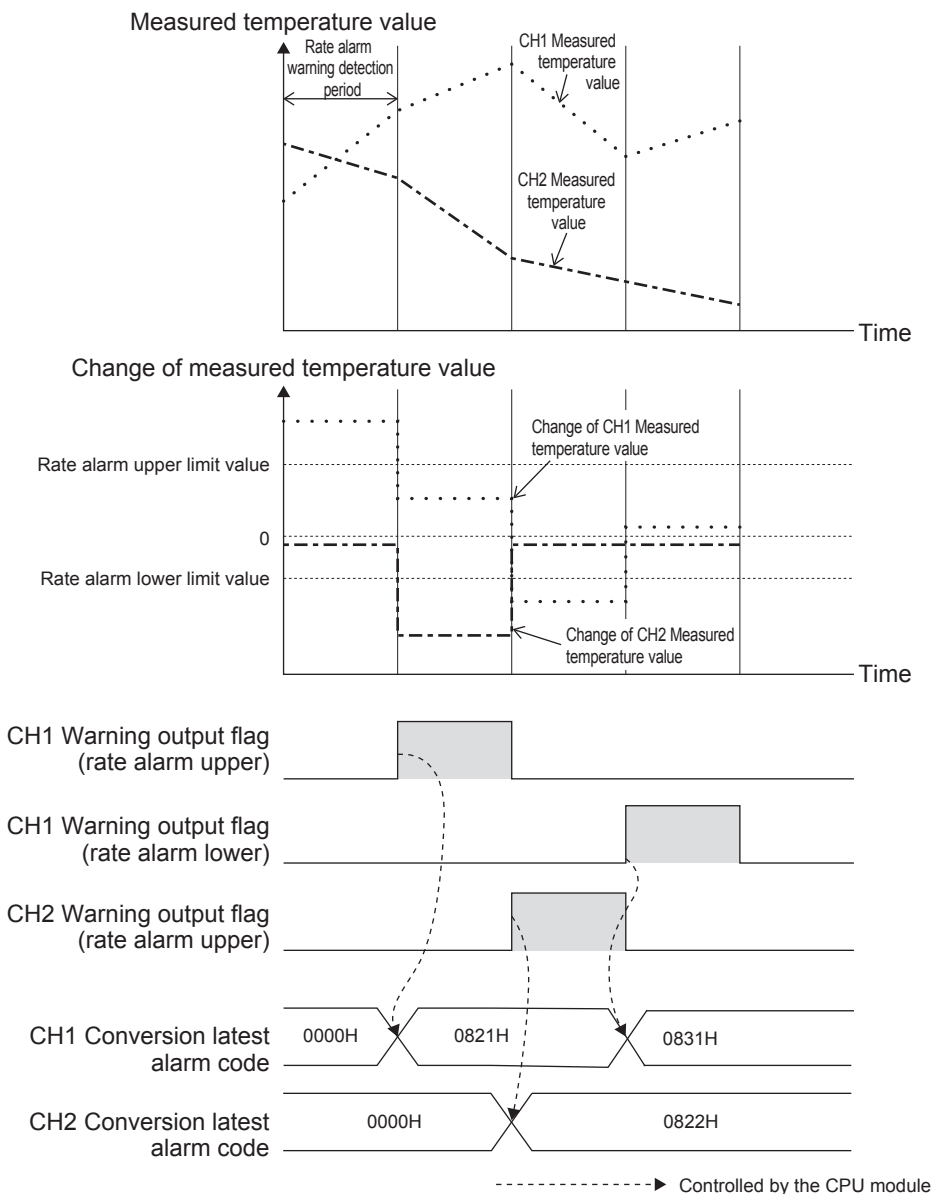

### ■ Operation

The measured temperature value is monitored every rate alarm warning detection period. When the change from the previous value is equal to or greater than the rate alarm upper limit value, or equal to or smaller than the rate alarm lower limit value, a warning output flag corresponding to "conversion alarm flag" turns on.

- The value is equal to or greater than the rate alarm upper limit value: "Warning output flag (rate alarm upper)" turns on. (Alarm code: 082□H)
- The value is equal to or smaller than the rate alarm lower limit value: "Warning output flag (rate alarm lower)" turns on. (Alarm code: 083□H)

After a warning is output, if the measured temperature value becomes out of the conditions where a warning is output, the corresponding warning output flag turns off.

- The value is smaller than the rate alarm upper limit value: "Warning output flag (rate alarm upper)" turns off.
- The value is greater than the rate alarm lower limit value: "Warning output flag (rate alarm lower)" turns off.

In addition, when the "warning output setting (rate alarm)" is changed to be disabled, "warning output flag (rate alarm upper)" and "warning output flag (rate alarm lower)" turn off. "Conversion alarm flag" and the alarm code stored in "conversion latest alarm code", however, are not cleared.



To clear "conversion alarm flag" and the alarm code stored in "conversion latest alarm code", turn on and off "conversion alarm clear request" after all of "warning output flag (rate alarm upper)" and "warning output flag (rate alarm lower)" turn off.

## Precautions

When "conversion enable/disable setting" is "enable", the data related to the warning output function (rate alarm) cannot be changed.

### ■Detection cycle

Set the rate alarm warning detection period in "rate alarm warning detection period setting".

### ■Judgment of rate alarm

A change rate is judged with the following formulae every rate alarm alert detection cycle.

- For alert outputting of rate alarm upper limit  
 $(\text{Current measured temperature value}) - (\text{Measured temperature value in the previous detection cycle}) \geq (\text{Rate alarm upper limit value})$
- For alert outputting of rate alarm lower limit  
 $(\text{Current measured temperature value}) - (\text{Measured temperature value in the previous detection cycle}) \leq (\text{Rate alarm lower limit value})$

#### Ex.

Judgment under the following conditions at Pt100 (-200 to +850°C)

- Rate alarm warning detection period setting: 150 (ms)
- Rate alarm upper limit value: 5000 (500.0°C)
- Rate alarm lower limit value: 1000 (100.0°C)

A measured temperature value of this time is compared to the previous value (measured temperature value 150ms before), every rate alarm alert detection cycle of 150ms. From the comparison, whether the increase in the measured temperature value is 5000 (500.0°C) or more, or 1000 (100.0°C) or less is judged.

#### Ex.

Judgment under the following conditions with thermocouple B (600 to 1700°C)

- Rate alarm warning detection period setting: 150 (ms)
- Rate alarm upper limit value: 10000 (1000.0°C)
- Rate alarm lower limit value: 7000 (700.0°C)

A measured temperature value of this time is compared to the previous value (measured temperature value 150 ms before), every rate alarm alert detection cycle of 150 ms. From the comparison, whether the increase in the measured temperature value is 10000 (1000.0°C) or more, or 7000 (700.0°C) or less is judged.

### ■Application examples of rate alarms

A rate alarm serves to monitor the change of a measured temperature value in a limited range as shown below.

#### Ex.

To monitor that the change of a measured temperature value (temperature unit: Celsius) rises within the specified range

Change of the measured temperature value (°C) (1) Rate alarm upper limit value  
(2) Rate alarm lower limit value

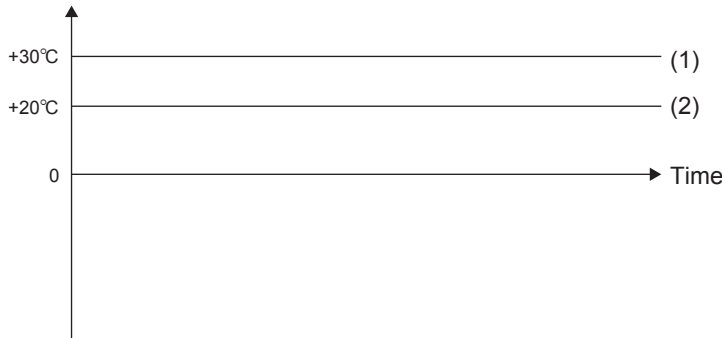

Ex.

To monitor that the change of a measured temperature value (temperature unit: Fahrenheit) falls within the specified range

Change of the measured temperature value (°F)

(1) Rate alarm upper limit value  
(2) Rate alarm lower limit value

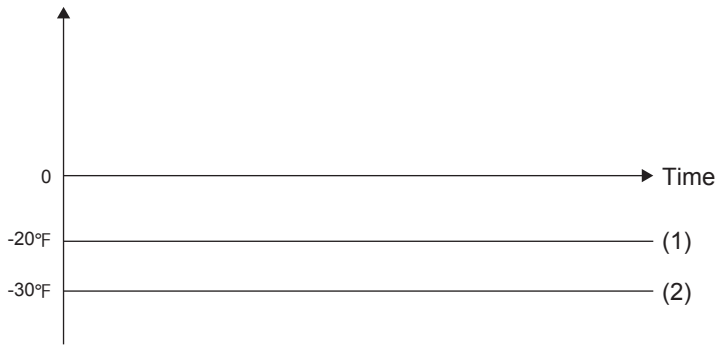

Ex.

To monitor that the change of a measured temperature value (temperature unit: Celsius) is within the specified range

Change of the measured temperature value (°C)

(1) Rate alarm upper limit value  
(2) Rate alarm lower limit value

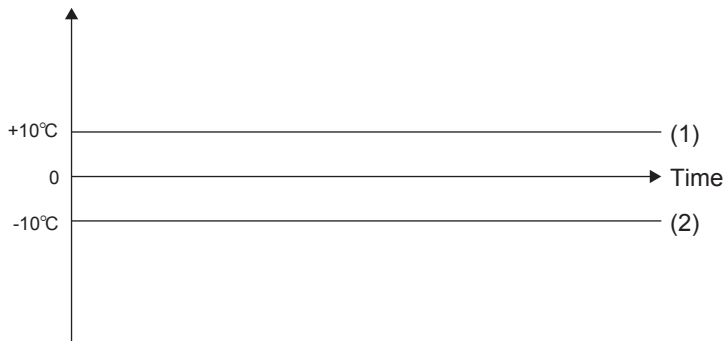

### Setting procedure

1. Set "Warning output function (Rate alarm)" to "Enable".

Navigation window ⇒ [Parameter] ⇒ [Module Information] ⇒ Module model name ⇒ [Module Parameter] ⇒ "Application Settings" ⇒ "Warning output function (Rate alarm)"

2. Set a value in "Rate alarm warning detection period setting".

Item	Setting range
Rate alarm warning detection period setting	85 to 10000 (ms)

#### Point

- When a value outside the setting range is set, the rate alarm warning detection period setting range error occurs. (Error code: 1A6□H)
- The rate alarm warning detection period is obtained by Set value + 1 scan time.

3. Set values for "Rate alarm upper limit value" and "Rate alarm lower limit value".

Item	Setting range
Rate alarm upper limit value	-3276.8 to 3276.7 <sup>*1</sup>
Rate alarm lower limit value	

\*1 If the temperature unit is Fahrenheit (°F), set the value in increments of 2 (0.2°F).

#### Point

Set values within the range satisfying the condition "Rate alarm upper limit value > Rate alarm lower limit value".

When not satisfying the above conditions, a rate alarm upper/lower limit setting value inversion error occurs. (Error code: 1A5□H)

## ■Corresponding devices

The devices used by the rate alarm are listed below.

Name	Connection part	Special relay			
		CH1	CH2	CH3	CH4
Warning output flag (rate alarm upper)	1st adapter	SM6315	SM6355	SM6395	SM6435
	2nd adapter	SM6675	SM6715	SM6755	SM6795
	3rd adapter	SM7035	SM7075	SM7115	SM7155
	4th adapter	SM7395	SM7435	SM7475	SM7515
Warning output flag (rate alarm lower)	1st adapter	SM6316	SM6356	SM6396	SM6436
	2nd adapter	SM6676	SM6716	SM6756	SM6796
	3rd adapter	SM7036	SM7076	SM7116	SM7156
	4th adapter	SM7396	SM7436	SM7476	SM7516
Warning output setting (rate alarm)	1st adapter	SM6317	SM6357	SM6397	SM6437
	2nd adapter	SM6677	SM6717	SM6757	SM6797
	3rd adapter	SM7037	SM7077	SM7117	SM7157
	4th adapter	SM7397	SM7437	SM7477	SM7517
Rate alarm upper limit value	1st adapter	SD6315	SD6355	SD6395	SD6435
	2nd adapter	SD6675	SD6715	SD6755	SD6795
	3rd adapter	SD7035	SD7075	SD7115	SD7155
	4th adapter	SD7395	SD7435	SD7475	SD7515
Rate alarm lower limit value	1st adapter	SD6316	SD6356	SD6396	SD6436
	2nd adapter	SD6676	SD6716	SD6756	SD6796
	3rd adapter	SD7036	SD7076	SD7116	SD7156
	4th adapter	SD7396	SD7436	SD7476	SD7516
Rate alarm warning detection period setting	1st adapter	SD6317	SD6357	SD6397	SD6437
	2nd adapter	SD6677	SD6717	SD6757	SD6797
	3rd adapter	SD7037	SD7077	SD7117	SD7157
	4th adapter	SD7397	SD7437	SD7477	SD7517

The details of the device used are listed below.

Name	Description	Setting value	Description	Default value	R/W
Warning output setting (rate alarm)	Set whether to enable or disable the warning output of rate alarm.	0: OFF	Warning output of rate alarm enable	1: ON	R/W
		1: ON	Warning output of rate alarm disable		
Warning output flag (rate alarm upper) Warning output flag (rate alarm lower)	Monitors the upper limit value warning and lower limit value warning of the rate alarm.	0: OFF	Normal	0: OFF	R
		1: ON	Rate alarm upper/lower limit detection		

Name	Description	Range	Default value	R/W
Rate alarm upper limit value Rate alarm lower limit value	Set the upper/lower limits of the change of a measured temperature value for detecting rate alarms. • When changing this device, set rate alarm upper limit value and rate alarm lower limit value within the same scan. • If the condition "rate alarm upper limit value > rate alarm lower limit value" is not satisfied, the rate alarm upper limit value/lower limit value setting inversion error (Error code: 1A5□H) occurs, and the temperature conversion cannot be performed.	-32768 to +32767 (If the temperature unit is Fahrenheit (°F), set the value in increments of 2 (0.2°F).)	0	R/W
Rate alarm warning detection period setting	Set the cycle for checking the change amount of the measured temperature value. If a value other than the setting value is set, the rate alarm warning detection period setting range error (Error code: 1A6□H) occurs, and the temperature conversion cannot be performed.	85 to 10000 (ms)	85	R/W

## Offset/gain setting function

FX5-4A-ADP

FX5-4AD-ADP

FX5-4DA-ADP

FX5-4AD-PT-ADP

FX5-4AD-TC-ADP

This function sets any analog (temperature) input values as offset and gain values (user range setting) instead of the preset settings. The function corrects error of the temperature conversion caused by noise or other factors. Note that the resolution is not changed. The set value is saved in the built-in memory of the analog adapter.

For changing the offset/gain data, set an analog value to the "offset temperature setting value" or "gain temperature setting value".

The table below shows the available setting range.

• FX5-4AD-PT-ADP

Item	Description	Setting range		
		Unit/RTD	Pt100	Ni100
Offset temperature setting value	Temperature setting value corresponding to the input offset value	Celsius (°C)	-200.0 to +850.0°C	-60.0 to +250.0°C
		Fahrenheit (°F)	-328.0 to +1562.0°F	-76.0 to +482.0°F
Gain temperature setting value	Temperature setting value corresponding to the input gain value	Celsius (°C)	-200.0 to +850.0°C	-60.0 to +250.0°C
		Fahrenheit (°F)	-328.0 to +1562.0°F	-76.0 to +482.0°F

If the "offset temperature setting value" and the "gain temperature setting value" are set using this function, the following values are also stored.

Item	Description	Setting range
Input offset value	Resistance value obtained by temperature conversion averaging processing when the measured temperature value reaches the lower limit value (offset reference value)	0 to 450000 (mΩ)
Input gain value	Resistance value obtained by temperature conversion averaging processing when the measured temperature value reaches the upper limit value (gain reference value)	

**Point**

The setting value is obtained from the built-in memory of the FX5-4AD-PT-ADP when "offset/gain reading" is set from OFF to ON or the power supply of the FX5-4AD-PT-ADP is turned off and on.

• FX5-4AD-TC-ADP

Item	Description	Setting range						
		Unit/Thermocouple	K	J	T	B	R	S
Offset temperature setting value	Temperature setting value corresponding to the input offset value	Celsius (°C)	-270.0 to +1370.0°C	-210.0 to +1130.0°C	-270.0 to +400.0°C	0 to 710.0°C	-50.0 to +1710.0°C	-50.0 to +1710.0°C
		Fahrenheit (°F)	-454.0 to +2498.0°F	-346.0 to +2066.0°F	-454.0 to +752.0°F	32.0 to 3110.0°F	-58.0 to +3110.0°F	-58.0 to +3110.0°F
Gain temperature setting value	Temperature setting value corresponding to the input gain value	Celsius (°C)	-270.0 to +1370.0°C	-210.0 to +1130.0°C	-270.0 to +400.0°C	0 to 710.0°C	-50.0 to +1710.0°C	-50.0 to +1710.0°C
		Fahrenheit (°F)	-454.0 to +2498.0°F	-346.0 to +2066.0°F	-454.0 to +752.0°F	32.0 to 3110.0°F	-58.0 to +3110.0°F	-58.0 to +3110.0°F

**Point**

When the offset temperature setting value and the gain temperature setting value do not satisfy the following condition, the offset/gain temperature setting value error occurs. (Error code: 1D1□H)

- When the temperature unit is centigrade: Gain temperature setting value - Offset temperature setting value > 0.1°C
- When the temperature unit is Fahrenheit: Gain temperature setting value - Offset temperature setting value > 0.3°F

If the "offset temperature setting value" and the "gain temperature setting value" are set using this function, the following values are also stored.

Item	Description	Setting range
Input offset value	Thermal EMF value obtained by temperature conversion averaging processing when the measured temperature value reaches the lower limit value (offset reference value)	0 to 78125 (μV)
Input gain value	Thermal EMF value obtained by temperature conversion averaging processing when the measured temperature value reaches the upper limit value (gain reference value)	

### Point

When "offset/gain reading" is set from OFF to ON or the power supply of the FX5-4AD-TC-ADP is turned off and on, the offset temperature setting value obtained from the built-in memory of the FX5-4AD-TC-ADP, the offset thermal EMF value calculated from the thermocouple type setting and the gain thermal EMF value are stored.

## Operation

### ■Offset/gain writing

For changing the offset/gain data, set "E215H" (for the FX5-4AD-PT-ADP) or "E21AH" (for the FX5-4AD-TC-ADP) to the "offset/gain writing enable code", and set the "offset/gain writing" from OFF to ON to write the "setting RTD type" or "setting thermocouple type", "offset temperature setting value", "gain temperature setting value", "input offset value", and "input gain value" to the built-in memory of the analog adapter. This enables the user range setting change for each channel, and the latest contents become valid.

When writing is completed, the "write offset/gain" automatically turns OFF. Also, the "offset/gain writing enable code" is cleared to 0.

When the "setting RTD type" or "setting thermocouple type" is changed, the initial value becomes valid.

For returning the offset/gain data to the initial value, use the offset/gain initialization function. ( Page 752 Offset/gain initialization function)

### Point

- The offset/gain value is written only when the "offset/gain writing enable code" is set to "E215H" (for the FX5-4AD-PT-ADP) or "E21AH" (for the FX5-4AD-TC-ADP).
- The offset/gain value can be written only while temperature conversion is disabled.
- The "conversion enable/disable setting" cannot be changed to "enable" while the offset/gain value is being written.

### ■Offset/gain reading

For reading the offset/gain data saved in the built-in memory of the analog adapter, set the "read offset/gain" from OFF to ON to read the "setting RTD type" or "setting thermocouple type", "offset temperature setting value", "gain temperature setting value", "input offset value" and "input gain value" from the built-in memory of the analog adapter.

If the RTD type setting or thermocouple type setting at the time of reading is the same as the "setting RTD type" or "setting thermocouple type" in the built-in memory of the analog adapter, the obtained values are stored in the "offset temperature setting value", "gain temperature setting value", "input offset value", and "input gain value". If the RTD type setting or thermocouple type setting is different, the initial value of the RTD type setting or thermocouple type setting at the time of reading is valid and set to the "offset temperature setting value", "gain temperature setting value", "input offset value", and "input gain value". Also, the offset/gain read RTD type or offset/gain read thermocouple type mismatch alarm occurs. (Alarm code: 0C0□H)

## Setting procedure

Access to the offset/gain setting window in the GX Works3 to set the offset and gain values.

The setting procedure for the offset/gain setting of the FX5-4A-ADP is as follows:

 [Tool] ⇒ [Module Tool List]

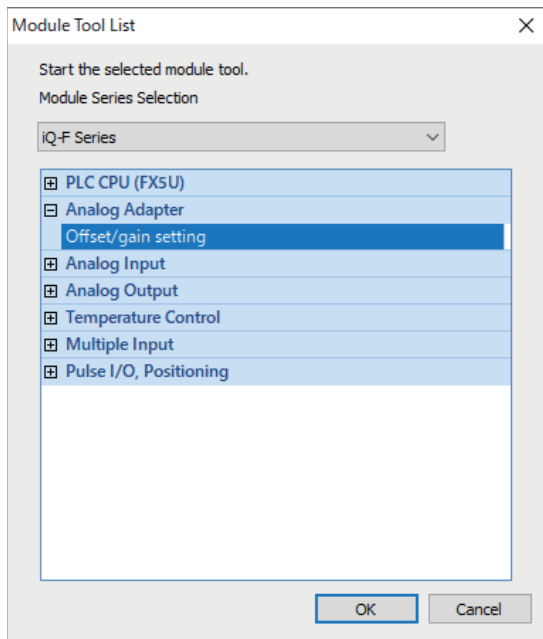

1. In "Analog Adapter", select "Offset/gain setting" and click [OK] button.

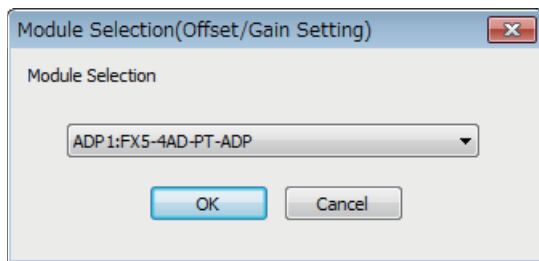

2. Select the target module for the offset/gain setting, and click [OK] button.

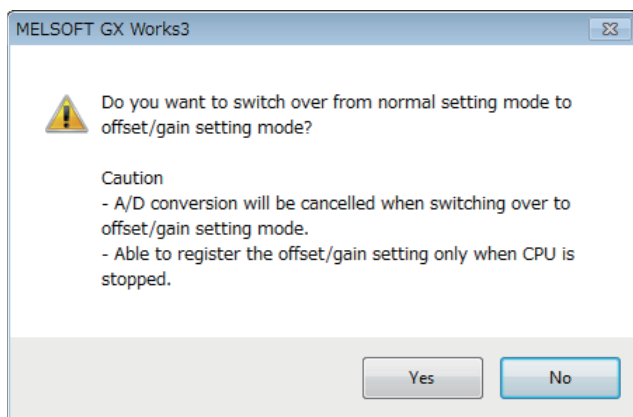

3. Click [Yes] button.

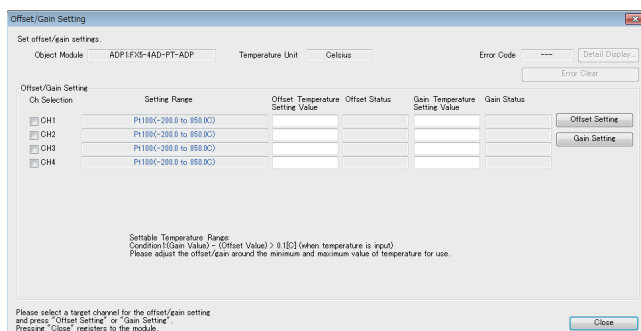

4. Mark the checkbox of the channel where offset and gain values are to be set, and click [Offset Setting] button.

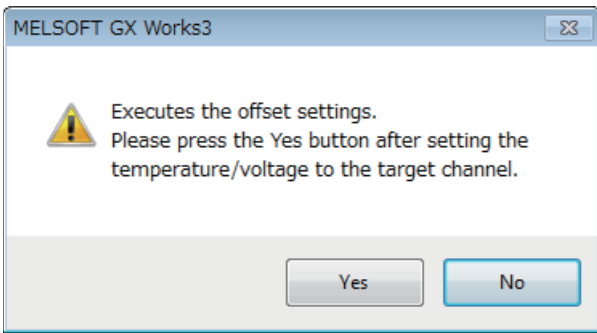

5. Apply the offset temperature to the terminal of the corresponding channel, and click [Yes] button.

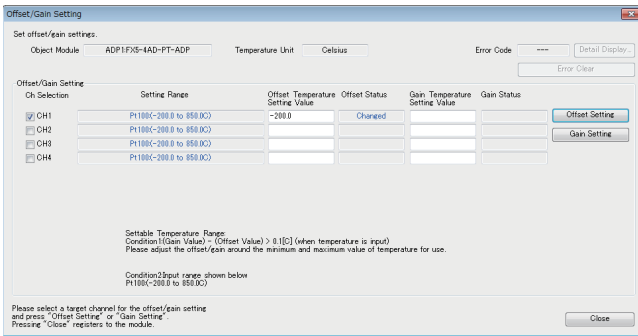

6. Check that "Offset Status" has changed to "Changed", and click [Gain Setting] button.

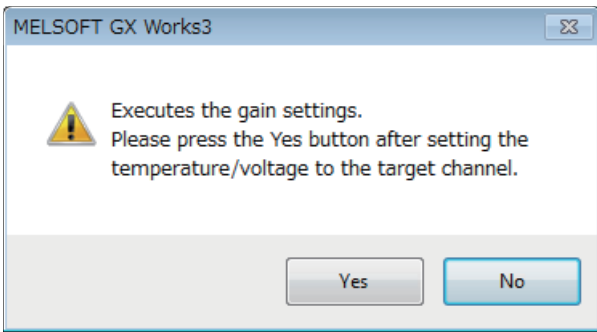

7. Apply the gain temperature to the terminal of the corresponding channel, and click [Yes] button.

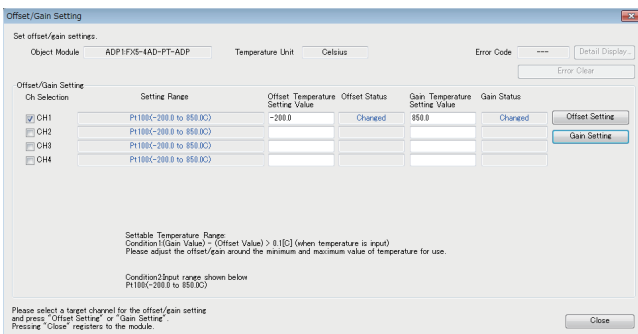

8. Check that "Gain Status" has changed to "Changed", and click [Close] button.

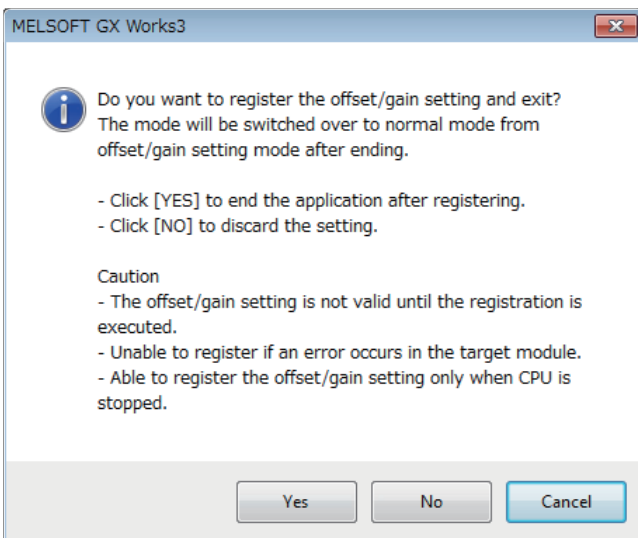

9. Click [Yes] button.

## Corresponding devices

The devices which are used by the offset/gain setting function are listed below.

Name	Connection part	Special relay			
		CH1	CH2	CH3	CH4
Offset/gain setting flag	1st adapter	SM6331	SM6371	SM6411	SM6451
	2nd adapter	SM6691	SM6731	SM6771	SM6811
	3rd adapter	SM7051	SM7091	SM7131	SM7171
	4th adapter	SM7411	SM7451	SM7491	SM7531
Read offset/gain	1st adapter	SM6332	SM6372	SM6412	SM6452
	2nd adapter	SM6692	SM6732	SM6772	SM6812
	3rd adapter	SM7052	SM7092	SM7132	SM7172
	4th adapter	SM7412	SM7452	SM7492	SM7532
Offset/gain writing	1st adapter	SM6333	SM6373	SM6413	SM6453
	2nd adapter	SM6693	SM6733	SM6773	SM6813
	3rd adapter	SM7053	SM7093	SM7133	SM7173
	4th adapter	SM7413	SM7453	SM7493	SM7533
Offset temperature setting value	1st adapter	SD6327	SD6367	SD6407	SD6447
	2nd adapter	SD6687	SD6727	SD6767	SD6807
	3rd adapter	SD7047	SD7087	SD7127	SD7167
	4th adapter	SD7407	SD7447	SD7487	SD7527
Gain temperature setting value	1st adapter	SD6328	SD6368	SD6408	SD6448
	2nd adapter	SD6688	SD6728	SD6768	SD6808
	3rd adapter	SD7048	SD7088	SD7128	SD7168
	4th adapter	SD7408	SD7448	SD7488	SD7528
Offset/gain writing enable code	1st adapter	SD6329	SD6369	SD6409	SD6449
	2nd adapter	SD6689	SD6729	SD6769	SD6809
	3rd adapter	SD7049	SD7089	SD7129	SD7169
	4th adapter	SD7409	SD7449	SD7489	SD7529
Input offset value (L)	1st adapter	SD6334	SD6374	SD6414	SD6454
	2nd adapter	SD6694	SD6734	SD6774	SD6814
	3rd adapter	SD7054	SD7094	SD7134	SD7174
	4th adapter	SD7414	SD7454	SD7494	SD7534
Input offset value (H)	1st adapter	SD6335	SD6375	SD6415	SD6455
	2nd adapter	SD6695	SD6735	SD6775	SD6815
	3rd adapter	SD7055	SD7095	SD7135	SD7175
	4th adapter	SD7415	SD7455	SD7495	SD7535
Input gain value (L)	1st adapter	SD6336	SD6376	SD6416	SD6456
	2nd adapter	SD6696	SD6736	SD6776	SD6816
	3rd adapter	SD7056	SD7096	SD7136	SD7176
	4th adapter	SD7416	SD7456	SD7496	SD7536
Input gain value (H)	1st adapter	SD6337	SD6377	SD6417	SD6457
	2nd adapter	SD6697	SD6737	SD6777	SD6817
	3rd adapter	SD7057	SD7097	SD7137	SD7177
	4th adapter	SD7417	SD7457	SD7497	SD7537

The details of the device used are listed below.

Name	Description	Setting value	Description	Default value	R/W
Offset/gain setting flag	The offset/gain setting used for each channel is monitored.	0: OFF	Initial value	0: OFF	R
		1: ON	User range setting		
Offset/gain reading	An offset/gain setting value is read.	0: OFF	Offset/gain reading is not performed.	0: OFF	R/W
		1: ON	Offset/gain reading is performed.		
Offset/gain writing	An offset/gain setting value is written in.	0: OFF	Offset/gain writing is not performed.	0: OFF	R/W
		1: ON	Offset/gain writing is performed.		



Name	Description	Range	Default value	R/W
Offset temperature setting value	Set the offset temperature setting value used in the offset/gain setting function.	<p>■FX5-4AD-PT-ADP Pt100 (Celsius): -2000 to +8500 Pt100 (Fahrenheit): -3280 to +15620*<sup>1</sup> NI100 (Celsius): -600 to +2500 NI100 (Fahrenheit): -760 to +4820*<sup>1</sup></p> <p>■FX5-4AD-TC-ADP K thermocouple (Celsius): -2700 to +13700 K thermocouple (Fahrenheit): -4540 to +24980*<sup>1</sup> J thermocouple (Celsius): -2100 to +11300 J thermocouple (Fahrenheit): -3460 to +20660*<sup>1</sup> T thermocouple (Celsius): -2700 to +4000 T thermocouple (Fahrenheit): -4540 to +7520*<sup>1</sup> B thermocouple (Celsius): 0 to 17100 B thermocouple (Fahrenheit): 320 to 31100*<sup>1</sup> R thermocouple (Celsius): -500 to +17100 R thermocouple (Fahrenheit): -580 to +31100*<sup>1</sup> S thermocouple (Celsius): -500 to +17100 S thermocouple (Fahrenheit): -580 to +31100*<sup>1</sup></p>	0	R/W
Gain temperature setting value	Set the gain temperature setting value used in the offset/gain setting function. The setting value is obtained from the built-in memory of the analog adapter when "offset/gain reading" is set from OFF to ON or the power supply of the analog adapter is turned off and on.	<p>■FX5-4AD-PT-ADP Pt100 (Celsius): -2000 to +8500 Pt100 (Fahrenheit): -3280 to +15620*<sup>1</sup> NI100 (Celsius): -600 to +2500 NI100 (Fahrenheit): -760 to +4820*<sup>1</sup></p> <p>■FX5-4AD-TC-ADP K thermocouple (Celsius): -2700 to +13700 K thermocouple (Fahrenheit): -4540 to +24980*<sup>1</sup> J thermocouple (Celsius): -2100 to +11300 J thermocouple (Fahrenheit): -3460 to +20660*<sup>1</sup> T thermocouple (Celsius): -2700 to +4000 T thermocouple (Fahrenheit): -4540 to +7520*<sup>1</sup> B thermocouple (Celsius): 0 to 17100 B thermocouple (Fahrenheit): 320 to 31100*<sup>1</sup> R thermocouple (Celsius): -500 to +17100 R thermocouple (Fahrenheit): -580 to +31100*<sup>1</sup> S thermocouple (Celsius): -500 to +17100 S thermocouple (Fahrenheit): -580 to +31100*<sup>1</sup></p>	8460	R/W

\*1 Set the value in increments of 2 (0.2°F).

Name	Description	Range	Default value	R/W
Offset/gain writing enable code	Set the offset/gain writing enable code used for changing the offset/gain. When "offset/gain writing" is set from OFF to ON while the offset/gain writing is enabled, the "setting RTD type", "offset temperature setting value", "gain temperature setting value", "input offset value", and "input gain value" are written to the built-in memory of the analog adapter.	<p>■FX5-4AD-PT-ADP Offset/gain writing enable: E215H Offset/gain writing disable: Other than E215H</p> <p>■FX5-4AD-TC-ADP Offset/gain writing enable: E21AH Offset/gain writing disable: Other than E21AH</p>	0	R/W
Input offset value	Set the offset value used in the offset/gain setting function. The setting value is obtained from the built-in memory of the analog adapter when "offset/gain reading" is set from OFF to ON or the power supply of the analog adapter is turned off and on.	<p>■FX5-4AD-PT-ADP 0 to 450000 (mΩ)</p> <p>■FX5-4AD-TC-ADP 0 to 78125 (μV)</p>	99820	R/W
Input gain value	Set the gain value used in the offset/gain setting function. The setting value is obtained from the built-in memory of the analog adapter when "offset/gain reading" is set from OFF to ON or the power supply of the analog adapter is turned off and on.	<p>■FX5-4AD-PT-ADP 0 to 450000 (mΩ)</p> <p>■FX5-4AD-TC-ADP 0 to 78125 (μV)</p>	388610	R/W

# Offset/gain initialization function



This function initializes the offset and gain values in the built-in memory of the analog adapter.  
 This function can be set only with special devices.

## Operation

Set "E215H" (for the FX5-4AD-PT-ADP) or "E21AH" (for the FX5-4AD-TC-ADP) to the "offset/gain writing enable code" and set the "offset/gain initialization" from OFF to ON to initialize the offset temperature setting value, gain temperature setting value, input offset value, and input gain value saved in the built-in memory of the analog adapter. When initialization is completed, the "offset/gain initialization" automatically turns OFF. Also, the "offset/gain writing enable code" is cleared to 0.

### Point

- Offset/gain initialization is executed when the "offset/gain writing enable code" is set to "E215H" (for the FX5-4AD-PT-ADP) or "E21AH" (for the FX5-4AD-TC-ADP).
- Offset/gain initialization is enabled only while temperature conversion is disabled.
- The "conversion enable/disable setting" cannot be changed to "enable" while offset/gain initialization is being executed.

## Setting procedure

1. Set the following to "offset/gain writing enable code".

Setting value		Description	Default value
FX5-4AD-PT-ADP	Other than E215H	Offset/gain writing disable	0
FX5-4AD-TC-ADP	E215H	Offset/gain writing enable	

### Point

When "offset/gain writing" is set from OFF to ON while the offset/gain writing is enabled, the "setting RTD type" or "setting thermocouple type", "offset temperature setting value", "gain temperature setting value", "input offset value", and "input gain value" are written to the built-in memory of the analog adapter.

2. Set "offset/gain initialization" from OFF to ON.

Setting value	Description	Default value
0: OFF	Offset/gain initialization is not performed.	0: OFF
1: ON	Offset/gain initialization is performed.	

## Corresponding devices

The devices which are used by the offset/gain initialization function are listed below.

Name	Connection part	Special relay			
		CH1	CH2	CH3	CH4
Offset/gain initialization	1st adapter	SM6334	SM6374	SM6414	SM6454
	2nd adapter	SM6694	SM6734	SM6774	SM6814
	3rd adapter	SM7054	SM7094	SM7134	SM7174
	4th adapter	SM7414	SM7454	SM7494	SM7534
Offset/gain writing enable code	1st adapter	SD6329	SD6369	SD6409	SD6449
	2nd adapter	SD6689	SD6729	SD6769	SD6809
	3rd adapter	SD7049	SD7089	SD7129	SD7169
	4th adapter	SD7409	SD7449	SD7489	SD7529

The details of the device used are listed below.

Name	Description	Setting value	Description	Default value	R/W
Offset/gain initialization	An input offset/gain value is initialized.	0: OFF	Offset/gain initialization is not performed.	0: OFF	R/W
		1: ON	Offset/gain initialization is performed.		
Name	Description	Range	Default value	R/W	
Offset/gain writing enable code	Set the offset/gain writing enable code used for changing the offset/gain.	<b>■FX5-4AD-PT-ADP</b> Offset/gain writing enable: E215H Offset/gain writing disable: Other than E215H	0	R/W	
		<b>■FX5-4AD-TC-ADP</b> Offset/gain writing enable: E21AH Offset/gain writing disable: Other than E21AH			

## 37.9 Other Functions

### Event history function

FX5-4A-ADP

FX5-4AD-ADP

FX5-4DA-ADP

FX5-4AD-PT-ADP

FX5-4AD-TC-ADP

This function collects errors from the analog adapter, and keeps them in the SD memory card, and data memory or battery backed built-in RAM of the CPU module.

The event information collected by the CPU module can be displayed on GX Works3 to check the occurrence history in chronological order.

Event type	Classification	Description
System	Error	An error detected by the self diagnostics in each module.

#### Setting procedure

The event history function can be set from the event history setting window of GX Works3. For the setting procedure, refer to the following.

 Page 131 Event history settings

#### Displaying event history

Access the menu of GX Works3. For details on the operating procedure and how to view the contents, refer to the following.

 GX Works3 Operating Manual

### Changing the setting value while the CPU module is operating

The following procedure shows how to operate with values other than those set in GX Works3 parameters (values of special relays and special registers).

#### Analog input

FX5-4A-ADP

FX5-4AD-ADP

FX5-4DA-ADP

FX5-4AD-PT-ADP

FX5-4AD-TC-ADP

**1.** Disable A/D conversion.

Set "A/D conversion enable/disable setting" to ON. ( Page 666 A/D conversion enable/disable setting function)

**2.** Change the value of a target special relay/device.

Change the value of a target device.

**3.** Enable A/D conversion.

Set "A/D conversion enable/disable setting" to OFF. ( Page 666 A/D conversion enable/disable setting function)

#### Precautions

- An alarm occurs when the value of a special relay/device is changed while A/D conversion is enabled (Alarm code: 0F0□H)
- When the value of a special relay/device related to the scaling, shift, average counts or averaging processing specification was changed in A/D conversion and "count average" or "moving average" was specified as the averaging processing, clear the number of times of sampling and execute sampling again from "0 time".

## Analog output

FX5-4A-ADP

FX5-4AD-ADP

FX5-4DA-ADP

FX5-4AD-PT-ADP

FX5-4AD-TC-ADP

1. Disable D/A conversion.

Set "D/A conversion enable/disable setting" to ON. (☞ Page 703 D/A conversion enable/disable function)

2. Change the value of a target special relay/device.

Change the value of a target device.

3. Enable D/A conversion.

Set "D/A conversion enable/disable setting" to OFF. (☞ Page 703 D/A conversion enable/disable function)

### Precautions

An alarm occurs when the value of a special relay/device is changed while D/A conversion is enabled (Alarm code: 0F00H)

37

## Temperature sensor input

FX5-4A-ADP

FX5-4AD-ADP

FX5-4DA-ADP

FX5-4AD-PT-ADP

FX5-4AD-TC-ADP

1. Disable temperature conversion.

Set "conversion enable/disable setting" to ON. (☞ Page 724 Conversion enable/disable setting function)

2. Change the value of a target special relay/device.

Change the value of a target device.

3. Enable temperature conversion.

Set "conversion enable/disable setting" to OFF. (☞ Page 724 Conversion enable/disable setting function)

### Precautions

- If the value of the special relay or special device has been changed while the temperature conversion is enabled, an alarm occurs and, at the END processing, the value is overwritten with the value used for the current operation. (Alarm code: 0F0□H)
- When the temperature conversion method is count average or moving average, if the temperature conversion is set to be disabled, the values of special relay or special device related to average counts and averaging process setting are changed, and the temperature conversion is set to be enabled again, the number of sampling times is cleared and the sampling is performed from 0 time.

## Starting/stopping the analog function in accordance with the CPU module status

FX5-4A-ADP

FX5-4AD-ADP

FX5-4DA-ADP

FX5-4AD-PT-ADP

FX5-4AD-TC-ADP

This paragraph shows the analog operation in accordance with the CPU module status.

Item	A/D conversion function	D/A conversion function
RUN	The module operates in accordance with its parameters.	The module operates in accordance with its parameters.
PAUSE	The module operates in accordance with its parameters.	The module operates in accordance with its parameters.
STOP	The module continues conversion.	Outputs are enabled even in the STOP status by using the analog output test mode available when the CPU module is in the STOP status. (☞ Page 722 Analog output test when CPU module is in STOP status function)

# Alarm clear request

## Analog input

FX5-4A-ADP

FX5-4AD-ADP

FX5-4DA-ADP

FX5-4AD-PT-ADP

FX5-4AD-TC-ADP

It is necessary to set the "A/D conversion alarm clear request" from OFF to ON to clear the alarm code.

The table below shows the necessity of the alarm clear request for turning OFF each flag and clearing the alarm code.

○: Alarm clear request required, —: Alarm clear request not required

Flag name	Alarm clear request required to turn OFF the flag	Alarm clear request required to clear the alarm code
A/D conversion completed flag	—	—
Over scale upper limit detection flag	○	○
Over scale lower limit detection flag	○	○
Maximum value/minimum value reset completed flag	—	—
Warning output flag (process alarm upper limit)	—	○
Warning output flag (process alarm lower limit)	—	○
Warning output flag (rate alarm upper)	—	○
Warning output flag (rate alarm lower)	—	○
Disconnection detection flag	○*1	○
Convergence detection flag	—	—
Deviation detection flag between channel	—	○
A/D conversion alarm flag	○	○
A/D conversion error flag	—	—

\*1 The alarm clear request is required when disconnection recovery is set to "disable".

### Point

- The "A/D conversion alarm clear request" ("alarm clear request" for the FX5-4AD-ADP) is required for flags which do not turn OFF automatically and flags which cause alarms.
- "A/D conversion alarm clear request" ("alarm clear request" for the FX5-4AD-ADP) does not turn OFF automatically. To perform an alarm clear again, it is necessary to turn it OFF once.
- For A/D conversion error flag and A/D conversion latest error code, use the "error clear request" (SM50) of the CPU module to clear them.

## Analog output

FX5-4A-ADP

FX5-4AD-ADP

FX5-4DA-ADP

FX5-4AD-PT-ADP

FX5-4AD-TC-ADP

It is necessary to set the "D/A conversion alarm clear request" from OFF to ON for clearing the alarm code.

The table below shows the necessity of the alarm clear request for turning OFF each flag and clearing the alarm code.

○: Alarm clear request required, —: Alarm clear request not required

Flag name	Alarm clear request required to turn OFF the flag	Alarm clear request required to clear the alarm code
Warning output upper limit value flag	○	○
Warning output lower limit value flag	○	○
Disconnection detection flag	—*1	—*2
D/A conversion alarm flag	○	○
D/A conversion error flag	—	—

\*1 The "error clear request" (SM50) of the CPU module is required when disconnection recovery is set to "disable".

\*2 To clear the error code, the "error clear request" (SM50) of the CPU module is required.

### Point

- The alarm clear of the CPU module request is required for flags which do not turn OFF automatically and flags which cause alarms.
- For the D/A conversion error flag and D/A conversion latest error code, use the "error clear request" (SM50) of the CPU module to clear them.

## Temperature sensor input

FX5-4A-ADP

FX5-4AD-ADP

FX5-4DA-ADP

FX5-4AD-PT-ADP

FX5-4AD-TC-ADP

It is necessary to set the "conversion alarm clear request" from OFF to ON to clear the alarm code.

The table below shows the necessity of the alarm clear request for turning OFF each flag and clearing the alarm code.

○: Alarm clear request required, —: Alarm clear request not required

Flag name	Alarm clear request required to turn OFF the flag	Alarm clear request required to clear the alarm code
Conversion completed flag	—	—
Maximum value/minimum value reset completed flag	—	—
Warning output flag (process alarm upper limit)	—	○
Warning output flag (process alarm lower limit)	—	○
Warning output flag (rate alarm upper)	—	○
Warning output flag (rate alarm lower)	—	○
Disconnection detection flag	○*1	○

\*1 The alarm clear request is required when "disconnection detection automatic clear enable/disable setting" is set to "disable".

### Point

- The "conversion alarm clear request" is required for flags which do not turn OFF automatically and flags which cause alarms.
- The "conversion alarm clear request" is not turned off automatically. To perform an alarm clear again, it is necessary to turn it OFF once.

# 37.10 Parameter Setting

Set the parameters of each channel.

**Point** 

In the explanation for each setting, the icons below indicate the compatible analog adapters. (The functions cannot be used by analog adapters marked with ×.)



Setting parameters here eliminates the need to program them.

**Point** 

Parameters are enabled when the CPU module is powered ON or after a reset. In addition, operations different from the parameter settings are possible by transferring values to special relays and special registers while changing these values in the program.

For the special relay and the special register, refer to the following.

 Page 772 Special Relay List

 Page 799 Special Register List

## Basic settings (analog input)



### Setting procedure

Open "Basic Settings" of the GX Works3.

**1.** Start Module parameter.

- FX5-4A-ADP

 Navigation window ⇒ [Parameter] ⇒ [Module Information] ⇒ Module model name ⇒ [Module Parameter] ⇒ "Basic Settings (Input)"

- FX5-4AD-ADP

 Navigation window ⇒ [Parameter] ⇒ [Module Information] ⇒ Module model name ⇒ [Module Parameter] ⇒ "Basic Settings"

### Window

Item	CH1	CH2	CH3	CH4
<b>A/D Conversion Enable/Disable Setting Function</b>	<b>Set A/D conversion method.</b>			
A/D Conversion Enable/Disable Setting	Disable	Disable	Disable	Disable
<b>A/D Conversion Method</b>	<b>Set A/D conversion method.</b>			
Average Processing Specify	Sampling Processing	Sampling Processing	Sampling Processing	Sampling Processing
Time Average Counts Average Moving Average	0 Times	0 Times	0 Times	0 Times
<b>Range switching function</b>	<b>Able to set the analog input range and to change the input conversion characteristics.</b>			
Input range setting	Input Voltage (0 to 10V)	Input Voltage (0 to 10V)	Input Voltage (0 to 10V)	Input Voltage (0 to 10V)

\*1 The FX5-4A-ADP uses only CH1 and CH2.



## Displayed items

Item	Description	Setting range	Default
A/D Conversion Enable/Disable Setting	Set whether to "enable" or "disable" AD conversion value output.	<ul style="list-style-type: none"> <li>• Disable</li> <li>• Enable</li> </ul>	Disable
Average Processing Specify	Execute whether to set "average process" or "sampling processing".	<ul style="list-style-type: none"> <li>• Sampling Processing</li> <li>• Time Average</li> <li>• Count Average</li> <li>• Moving Average</li> </ul>	Sampling Processing
Time Average Counts Average Moving Average	Set average time, average counts, moving average counts when specifying average process for each channel.	Set range setting for each channel.	—
Input range setting	Setting area for input range setting.	<ul style="list-style-type: none"> <li>• Voltage input (0 to 10V)</li> <li>• Voltage input (0 to 5V)</li> <li>• Voltage input (1 to 5V)</li> <li>• Voltage input (-10 to 10V)</li> <li>• Current input (0 to 20mA)</li> <li>• Current input (4 to 20mA)</li> <li>• Current input (-20 to 20mA)</li> </ul>	Voltage input (0 to 10V)

**2.** Click the item to be changed to enter the setting value.

- Item where a value is selected from the pull-down list

Click [▼] button of the item to be set, and from the pull-down list that appears, select the value.

- Item where a value is entered into the text box

Double-click the item to be set to enter the numeric value.

# Application settings (analog input)

FX5-4A-ADP

FX5-4AD-ADP

FX5-4DA-ADP

FX5-4AD-PT-ADP

FX5-4AD-TC-ADP

## Setting procedure

Open "Application Settings" of the GX Works3.

### 1. Start Module parameter.

- FX5-4A-ADP

Navigation window ⇒ [Parameter] ⇒ [Module Information] ⇒ Module model name ⇒ [Module Parameter] ⇒ "Application Settings (Input)"

- FX5-4AD-ADP

Navigation window ⇒ [Parameter] ⇒ [Module Information] ⇒ Module model name ⇒ [Module Parameter] ⇒ "Application Settings"

## Window

Item	CH1	CH2	CH3	CH4
<b>Warning output function (Process alarm)</b>	<b>Execute the setting related to warning at A/D conversion.</b>			
Warning output setting (Process alarm)	Disable	Disable	Disable	Disable
Process Alarm Upper Upper Limit Value	0	0	0	0
Process Alarm Upper Lower Limit Value	0	0	0	0
Process Alarm Lower Upper Limit Value	0	0	0	0
Process Alarm Lower Lower Limit Value	0	0	0	0
<b>Warning output function (Rate alarm)</b>	<b>Set the value for the warning when A/D conversion is executed.</b>			
Warning output setting (Rate alarm)	Disable	Disable	Disable	Disable
Rate alarm warning detection period setting	1 ms	1 ms	1 ms	1 ms
Rate alarm upper limit value	0	0	0	0
Rate alarm lower limit value	0	0	0	0
<b>Over Scale Detection</b>	<b>Execute the setting related to analog input value detection which exceeds the setting range.</b>			
Over Scale Detection Enable/Disable	Disable	Disable	Disable	Disable
<b>Scaling Setting</b>	<b>Execute the setting related to scaling at A/D conversion.</b>			
Scaling Enable/Disable	Disable	Disable	Disable	Disable
Scaling Upper Limit Value	0	0	0	0
Scaling Lower Limit Value	0	0	0	0
<b>Shift Function</b>	<b>Execute the setting related to shift function at A/D conversion.</b>			
Shifting amount to conversion value	0	0	0	0
<b>Digital Clip Setting</b>	<b>Execute the setting related to digital clip function at A/D conversion.</b>			
Digital Clip Enable/Disable	Disable	Disable	Disable	Disable
<b>Disconnection detection function</b>	<b>Set value for Disconnection detection.</b>			
Disconnection detection enable/disable setting	Disable	Disable	Disable	Disable
Disconnection recovery detection enable/disable setting	Disable	Disable	Disable	Disable
<b>Convergence detection function</b>	<b>Set value for Convergence detection.</b>			
Convergence detection enable/disable setting	Disable	Disable	Disable	Disable
Convergence detection upper limit value	0	0	0	0
Convergence detection lower limit value	0	0	0	0
Detection time setting for Convergence detection	1 ms	1 ms	1 ms	1 ms
<b>Deviation detection function between channels</b>	<b>Set value for Deviation detection between channels.</b>			
Deviation detection trigger between channels	Disable	Disable	Disable	Disable
Deviation value for deviation detection between channels	0	0	0	0
Target CH setting for deviation detection between channels: No.1 CH1	Non-target	Non-target	Non-target	Non-target

\*1 The FX5-4A-ADP uses only CH1 and CH2.

## Displayed items

Item	Description	Setting range	Default
Warning output setting (Process alarm)	Set whether to "enable" or "disable" process alarm warning.	• Disable • Enable	Disable
Process Alarm Upper Upper Limit Value	Set the upper upper limit value of the digital output value.	-32768 to +32767	—
Process Alarm Upper Lower Limit Value	Set the upper lower limit value of the digital output value.	-32768 to +32767	—
Process Alarm Lower Upper Limit Value	Set the lower upper limit value of the digital output value.	-32768 to +32767	—
Process Alarm Lower Lower Limit Value	Set the lower lower limit value of the digital output value.	-32768 to +32767	—
Warning output setting (Rate alarm)	Set whether to "enable" or "disable" the rate alarm warning.	• Disable • Enable	Disable
Rate alarm warning detection period setting	Set the value for the sampling cycle to detect the rate alarm warning.	1 to 10000	—
Rate alarm upper limit value	Set the upper limit value of the digital output value.	-999 to +1000	—
Rate alarm lower limit value	Set the lower limit value of the digital output value.	-1000 to +999	—
Over Scale Detection Enable/Disable	Set whether to "enable" or "disable" over scale detection.	• Disable • Enable	Disable
Scaling Enable/Disable	Set whether to "enable" or "disable" scaling.	• Disable • Enable	Disable
Scaling Upper Limit Value	Set the upper limit value for scaling calculation.	-32768 to +32767	—
Scaling Lower Limit Value	Set the lower limit value for scaling calculation.	-32768 to +32767	—
Conversion value shift amount	Set shifting amount for shifting function.	-32768 to +32767	0
Digital Clip Enable/Disable	Set whether to "enable" or "disable" digital clip.	• Disable • Enable	Disable
Disconnection detection enable/disable setting	Set whether to "enable" or "disable" disconnection detection.	• Disable • Enable	Disable
Disconnection recovery detection enable/disable setting	Set whether to "enable" or "disable" recovery from the disconnection detected.	• Disable • Enable	Disable
Convergence detection enable/disable setting	Set whether to "enable" or "disable" convergence detection.	• Disable • Enable	Disable
Convergence detection upper limit value	Set the upper limit value of the convergence range (range where digital operation values are checked).	-32767 to +32767	—
Convergence detection lower limit value	Set the lower limit value of the convergence range (range where digital operation values are checked).	-32768 to +32766	—
Detection time setting for Convergence detection	Set the detection time (range where digital operation values are checked).	1 to 10000	—
Deviation detection trigger between channels	Set whether to "enable" or "disable" deviation detection between channels.	• Disable • Enable	Disable
Deviation value for deviation detection between channels	Set the deviation value for deviation detection between channels.	0 to 65535	—
Target CH setting for deviation detection between channels: No.1 to 4, CH1 to CH4*2	Set whether to target each channel for deviation detection between channels.	• Non-target • Target	Non-target

\*2 For the FX5-4A-ADP, set only CH1 and CH2.

**2.** Click the item to be changed to enter the setting value.

- Item where a value is selected from the pull-down list

Click [▼] button of the item to be set, and from the pull-down list that appears, select the value.

- Item where a value is entered into the text box

Double-click the item to be set to enter the numeric value.

# Basic settings (analog output)



## Setting procedure

Open "Basic Settings" of the GX Works3.

### 1. Start Module parameter.

- FX5-4A-ADP

Navigation window ⇒ [Parameter] ⇒ [Module Information] ⇒ Module model name ⇒ [Module Parameter] ⇒ "Basic Settings (Output)"

- FX5-4DA-ADP

Navigation window ⇒ [Parameter] ⇒ [Module Information] ⇒ Module model name ⇒ [Module Parameter] ⇒ "Basic Settings"

## Window

Item	CH1	CH2	CH3	CH4
<b>D/A Conversion Enable/Disable Setting Function</b>	<b>Set Enable/Disable D/A conversion.</b>			
D/A Conversion Enable/Disable Setting	Disable	Disable	Disable	Disable
<b>D/A Output Enable/Disable Setting</b>	<b>Set Enable/Disable D/A output.</b>			
D/A Output Enable/Disable Setting	Disable	Disable	Disable	Disable
<b>Range switching function</b>	<b>Able to set the analog input range and to change the input conversion characteristics.</b>			
Output range setting	Output Voltage (0 to 10V)	Output Voltage (0 to 10V)	Output Voltage (0 to 10V)	Output Voltage (0 to 10V)

\*1 The FX5-4A-ADP uses only CH1 and CH2.

## Displayed items

Item	Description	Setting range	Default
D/A Conversion Enable/Disable Setting	Set whether to "enable" or "disable" D/A conversion.	<ul style="list-style-type: none"> <li>• Disable</li> <li>• Enable</li> </ul>	Disable
D/A Output Enable/Disable Setting	Set whether to "enable" or "disable" D/A output.	<ul style="list-style-type: none"> <li>• Disable</li> <li>• Enable</li> </ul>	Disable
Output range setting	Setting area for output range setting.	<ul style="list-style-type: none"> <li>• Voltage output (0 to 10V)</li> <li>• Voltage output (0 to 5V)</li> <li>• Voltage output (1 to 5V)</li> <li>• Voltage output (-10 to 10V)</li> <li>• Current output (0 to 20mA)</li> <li>• Current output (4 to 20mA)</li> </ul>	Voltage output (0 to 10V)

### 2. Click the item to be changed to enter the setting value.

- Item where a value is selected from the pull-down list

Click [▼] button of the item to be set, and from the pull-down list that appears, select the value.

- Item where a value is entered into the text box

Double-click the item to be set to enter the numeric value.

# Application settings (analog output)

FX5-4A-ADP

FX5-4AD-ADP

FX5-4DA-ADP

FX5-4AD-PT-ADP

FX5-4AD-TC-ADP

## Setting procedure

Open "Application Settings" of the GX Works3.

### 1. Start Module parameter.

- FX5-4A-ADP

Navigation window ⇒ [Parameter] ⇒ [Module Information] ⇒ Module model name ⇒ [Module Parameter] ⇒ "Application Settings (Output)"

- FX5-4DA-ADP

Navigation window ⇒ [Parameter] ⇒ [Module Information] ⇒ Module model name ⇒ [Module Parameter] ⇒ "Application Settings"

37

## Window

Item	CH3	CH4
<b>Warning Output Function</b>	<b>Execute the setting related to D/A conversion warning.</b>	
Warning Output Setting	Disable	Disable
Warning output upper limit value	0	0
Warning output lower limit value	0	0
<b>Scaling Setting</b>	<b>Execute the setting related to D/A conversion scaling.</b>	
Scaling Enable/Disable	Disable	Disable
Scaling Upper Limit Value	0	0
Scaling Lower Limit Value	0	0
<b>Shift Function</b>	<b>Execute the setting related to D/A conversion shift function.</b>	
Shifting amount to conversion value	0	0
<b>Analog Output HOLD/CLEAR Setting</b>	<b>Set whether to HOLD the last value or setting value, or to CLEAR the digital value to be converted to analog value.</b>	
HOLD/CLEAR Setting	Current Value (Hold)	Current Value (Hold)
HOLD Setting Value	0	0
<b>Disconnection detection function</b>	<b>Execute the setting related to disconnection detection.</b>	
Disconnection detection enable/disable setting	Disable	Disable
Disconnection recovery detection enable/disable setting	Disable	Disable

## Displayed items

Item	Description	Setting range	Default
Warning Output Setting	Set whether to "enable" or "disable" warning output.	<ul style="list-style-type: none"> <li>• Enable</li> <li>• Disable</li> </ul>	Disable
Warning output upper limit value	Set the upper limit value of the digital input value for warning output.	-32767 to +32767	—
Warning output lower limit value	Set the lower limit value of the digital input value for warning output.	-32768 to +32766	—
Scaling Enable/Disable	Set whether to "enable" or "disable" scaling.	<ul style="list-style-type: none"> <li>• Disable</li> <li>• Enable</li> </ul>	Disable
Scaling Upper Limit Value	Set the upper limit value for scaling calculation.	-32768 to +32767	—
Scaling Lower Limit Value	Set the lower limit value for scaling calculation.	-32768 to +32767	—
Conversion value shift amount	Set shifting amount for shifting function.	-32768 to +32767	0
HOLD/CLEAR Setting	Set output status at CLEAR or HOLD.	<ul style="list-style-type: none"> <li>• CLEAR</li> <li>• Previous Value (Hold)</li> <li>• Setting Value</li> </ul>	Previous Value (Hold)
HOLD Setting Value	Set a digital value to be output at HOLD when "Setting Value" is selected in "HOLD/CLEAR Setting".	-32768 to +32767	—
Disconnection detection enable/disable setting	Set whether to "enable" or "disable" disconnection detection.	<ul style="list-style-type: none"> <li>• Disable</li> <li>• Enable</li> </ul>	Disable
Disconnection recovery detection enable/disable setting	Set whether to "enable" or "disable" recovery from the disconnection detected.	<ul style="list-style-type: none"> <li>• Disable</li> <li>• Enable</li> </ul>	Disable

2. Click the item to be changed to enter the setting value.

- Item where a value is selected from the pull-down list

Click [▼] button of the item to be set, and from the pull-down list that appears, select the value.

- Item where a value is entered into the text box

Double-click the item to be set to enter the numeric value.

## Basic settings (temperature sensor input)



### Setting procedure

Open "Basic Settings" of the GX Works3.

1. Start Module parameter.

Navigation window ⇒ [Parameter] ⇒ [Module Information] ⇒ Module model name ⇒ [Module Parameter] ⇒ "Basic Settings"

### Window

- FX5-4A-PT-ADP

Item	CH1	CH2	CH3	CH4
<input type="checkbox"/> <b>Temperature unit selection function</b>	<b>Set the temperature unit selection function.</b>			
Temperature unit setting	Celsius			
<input type="checkbox"/> <b>Conversion enable/disable setting function</b>	<b>Set the Conversion enable/disable function.</b>			
Conversion enable/disable setting	Disable	Disable	Disable	Disable
<input type="checkbox"/> <b>Temperature conversion method</b>	<b>Set the temperature conversion method.</b>			
Average Processing Specification	Sampling Processing	Sampling Processing	Sampling Processing	Sampling Processing
Time Average Counts Average Moving Average	0 Times	0 Times	0 Times	0 Times
<input type="checkbox"/> <b>Resistance temperature detector type selection function</b>	<b>Set the resistance temperature detector type.</b>			
Resistance temperature detector type setting	Pt100 (-200 to 850 C)	Pt100 (-200 to 850 C)	Pt100 (-200 to 850 C)	Pt100 (-200 to 850 C)

- FX5-4A-TC-ADP

Item	CH1	CH2	CH3	CH4
<input type="checkbox"/> <b>Temperature unit selection function</b>	<b>Set the temperature unit selection function.</b>			
Temperature unit setting	Celsius			
<input type="checkbox"/> <b>Conversion enable/disable setting function</b>	<b>Set the Conversion enable/disable function.</b>			
Conversion enable/disable setting	Disable	Disable	Disable	Disable
<input type="checkbox"/> <b>Temperature conversion method</b>	<b>Set the temperature conversion method.</b>			
Average Processing Specification	Sampling Processing	Sampling Processing	Sampling Processing	Sampling Processing
Time Average Counts Average Moving Average	0 Times	0 Times	0 Times	0 Times
<input type="checkbox"/> <b>Thermocouple type selection function</b>	<b>Set the thermocouple type.</b>			
Thermocouple type setting	K (-270 to 1370 C)	K (-270 to 1370 C)	K (-270 to 1370 C)	K (-270 to 1370 C)

## Displayed items

Item	Description	Setting range	Default
Temperature unit setting	Set whether to use 'Celsius' or 'Fahrenheit' as the temperature unit.	<ul style="list-style-type: none"> <li>• Celsius</li> <li>• Fahrenheit</li> </ul>	Celsius
Conversion enable/disable setting	Set whether to 'Enable' or 'Disable' output of conversion values for each channel.	<ul style="list-style-type: none"> <li>• Disable</li> <li>• Enabled</li> </ul>	Disable
Average Processing Specify	Execute whether to set "average process" or "sampling processing".	<ul style="list-style-type: none"> <li>• Sampling Processing</li> <li>• Time Average</li> <li>• Count Average</li> <li>• Moving Average</li> </ul>	Sampling Processing
Time Average Counts Average Moving Average	Set average time, average counts, moving average counts for each channel.	Set range setting for each channel.	—
Resistance temperature detector type setting	Set the resistance temperature detector type to connect for each channel.	<ul style="list-style-type: none"> <li>■ Celsius <ul style="list-style-type: none"> <li>• Pt100 (-200 to 850°C)</li> <li>• Ni100 (-60 to 250°C)</li> </ul> </li> <li>■ Fahrenheit <ul style="list-style-type: none"> <li>• Pt100 (-328 to 1562°F)</li> <li>• Ni100 (-76 to 482°F)</li> </ul> </li> </ul>	—
Thermocouple type setting	Set the thermocouple type to connect for each channel.	<ul style="list-style-type: none"> <li>■ Celsius <ul style="list-style-type: none"> <li>• K (-270 to 1370°C)</li> <li>• J (-210 to 1130°C)</li> <li>• T (-270 to 400°C)</li> <li>• B (0 to 1710°C)</li> <li>• R (-50 to 1710°C)</li> <li>• S (-50 to 1710°C)</li> </ul> </li> <li>■ Fahrenheit <ul style="list-style-type: none"> <li>• K (-454 to 2498°F)</li> <li>• J (-346 to 2066°F)</li> <li>• T (-454 to 752°F)</li> <li>• B (32 to 3110°F)</li> <li>• R (-58 to 3110°F)</li> <li>• S (-58 to 3110°F)</li> </ul> </li> </ul>	—

**2.** Click the item to be changed to enter the setting value.

- Item where a value is selected from the pull-down list

Click [▼] button of the item to be set, and from the pull-down list that appears, select the value.

- Item where a value is entered into the text box

Double-click the item to be set to enter the numeric value.

# Application settings (temperature sensor input)

FX5-4A-ADP

FX5-4AD-ADP

FX5-4DA-ADP

FX5-4AD-PT-ADP

FX5-4AD-TC-ADP

## Setting procedure

Open "Application Settings" of the GX Works3.

### 1. Start Module parameter.

Navigation window ⇒ [Parameter] ⇒ [Module Information] ⇒ Module model name ⇒ [Module Parameter] ⇒ "Application Settings"

## Window

Item	CH1	CH2	CH3	CH4
<b>Warning output function (Process alarm)</b>	<b>Execute the setting related to A/D conversion warning.</b>			
Warning output setting (Process alarm)	Disable	Disable	Disable	Disable
Process Alarm Upper Upper Limit Value	850.0 C	850.0 C	850.0 C	850.0 C
Process Alarm Upper Lower Limit Value	850.0 C	850.0 C	850.0 C	850.0 C
Process Alarm Lower Upper Limit Value	-200.0 C	-200.0 C	-200.0 C	-200.0 C
Process Alarm Lower Lower Limit Value	-200.0 C	-200.0 C	-200.0 C	-200.0 C
<b>Warning output function (Rate alarm)</b>	<b>Execute the setting related to A/D conversion warning.</b>			
Warning output setting (Rate alarm)	Disable	Disable	Disable	Disable
Rate alarm warning detection period setting	85 ms	85 ms	85 ms	85 ms
Rate alarm upper limit value	0.0 C	0.0 C	0.0 C	0.0 C
Rate alarm lower limit value	0.0 C	0.0 C	0.0 C	0.0 C
<b>Disconnection detection function</b>	<b>Execute the setting related to disconnection detection.</b>			
Disconnection detection enable/disable setting	Enable	Enable	Enable	Enable
Conversion setting for disconnection detection	Downscale	Downscale	Downscale	Downscale
Conversion setting function for disconnection detection	0.0 C	0.0 C	0.0 C	0.0 C
Enable/Disable setting for disconnection detection automatic clear	Disable	Disable	Disable	Disable

## Displayed items

Item	Description	Setting range	Default
Warning output setting (Process alarm)	Set whether to "enable" or "disable" process alarm warning.	<ul style="list-style-type: none"> <li>Disable</li> <li>Enabled</li> </ul>	Disable
Process Alarm Upper Upper Limit Value	Set upper upper limit value of measured temperature value	-3276.8 to +3276.7	—
Process Alarm Upper Lower Limit Value	Set upper lower limit value of measured temperature value.	-3276.8 to +3276.7	—
Process Alarm Lower Upper Limit Value	Set lower upper limit value of measured temperature value.	-3276.8 to +3276.7	—
Process Alarm Lower Lower Limit Value	Set lower lower limit value of measured temperature value.	-3276.8 to +3276.7	—
Warning output setting (rate alarm)	Set whether to "enable" or "disable" the rate alarm warning.	<ul style="list-style-type: none"> <li>Disable</li> <li>Enabled</li> </ul>	Disable
Rate alarm warning detection period setting	Set the value for the sampling cycle to detect the rate alarm warning.	85 to 10000	—
Rate alarm upper limit value	Set the upper limit value of the measured temperature value.	-3276.8 to +3276.7	—
Rate alarm lower limit value	Set the lower limit value of the measured temperature value.	-3276.8 to +3276.7	—
Disconnection detection enable/disable setting	Set whether to "enable" or "disable" disconnection detection.	<ul style="list-style-type: none"> <li>Enable</li> <li>Disable</li> </ul>	Enable
Conversion setting for disconnection detection	In disconnection detection function, set the value to be converted detecting for each channel.	<ul style="list-style-type: none"> <li>Upscale</li> <li>Downscale</li> <li>Any value</li> <li>Value before disconnection</li> </ul>	Downscale
Conversion setting function for disconnection detection	Set the value to convert when 'Any value' is selected for conversion setting function for disconnection detection.	-3276.8 to +3276.7	—
Enable/Disable setting for disconnection detection automatic clear	Set whether to 'Enable' or 'Disable' the auto-clear of the disconnection detection for disconnection detection function.	<ul style="list-style-type: none"> <li>Enable</li> <li>Disable</li> </ul>	Disable



2. Click the item to be changed to enter the setting value.

- Item where a value is selected from the pull-down list

Click [▼] button of the item to be set, and from the pull-down list that appears, select the value.

- Item where a value is entered into the text box

Double-click the item to be set to enter the numeric value.

## 37.11 Troubleshooting

This section describes errors that may occur in the use of the analog adapters, and those troubleshooting.

### Troubleshooting with the LEDs

Check the state of the LED to narrow down the possible causes of the trouble. This step is the first diagnostics.

The status of the analog adapter can be checked with the PWR LED. The following table shows the correspondence between the LED and analog adapter status.

Name	Description
PWR LED	Indicates the power supply status of the analog adapter. On: The power supply is supplied. Off: The power supply is not supplied.

### Checking the state of the module

Check the error code (alarm code) and error history of the analog adapter from the module diagnostics window of the GX Works3.

 [Diagnostics] ⇒ [Module Diagnostics(CPU Diagnostics)]

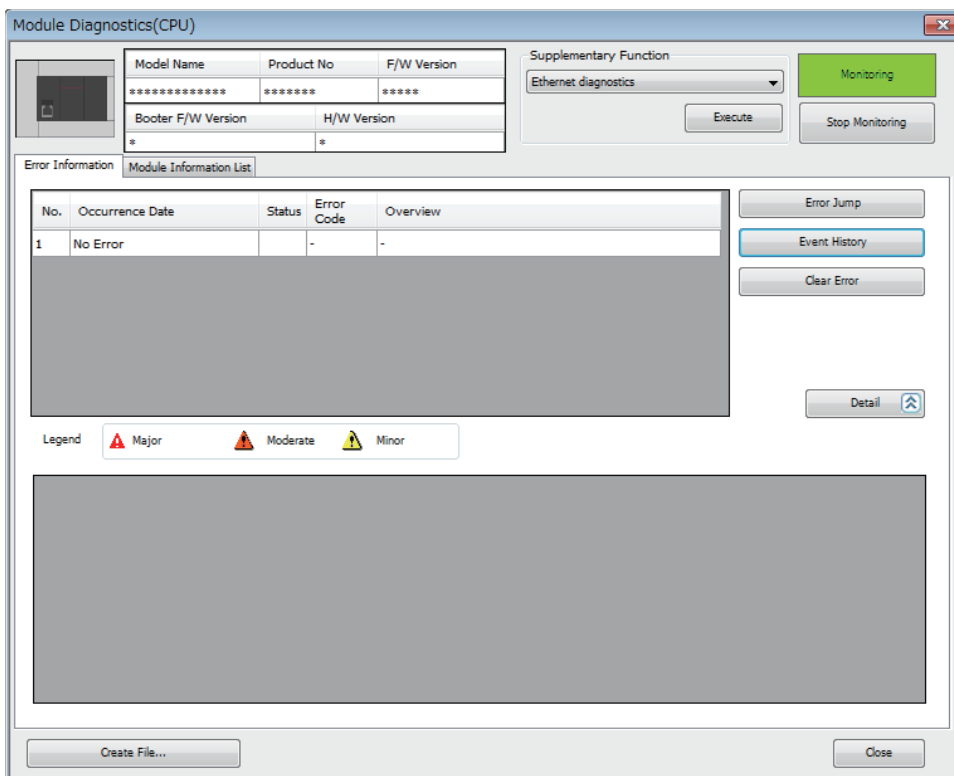

Error history, alarm history can be checked with the event history window of the GX Works3.

[Diagnostics] ⇒ [Module Diagnostics (CPU Diagnostics)] ⇒ [Event History] button

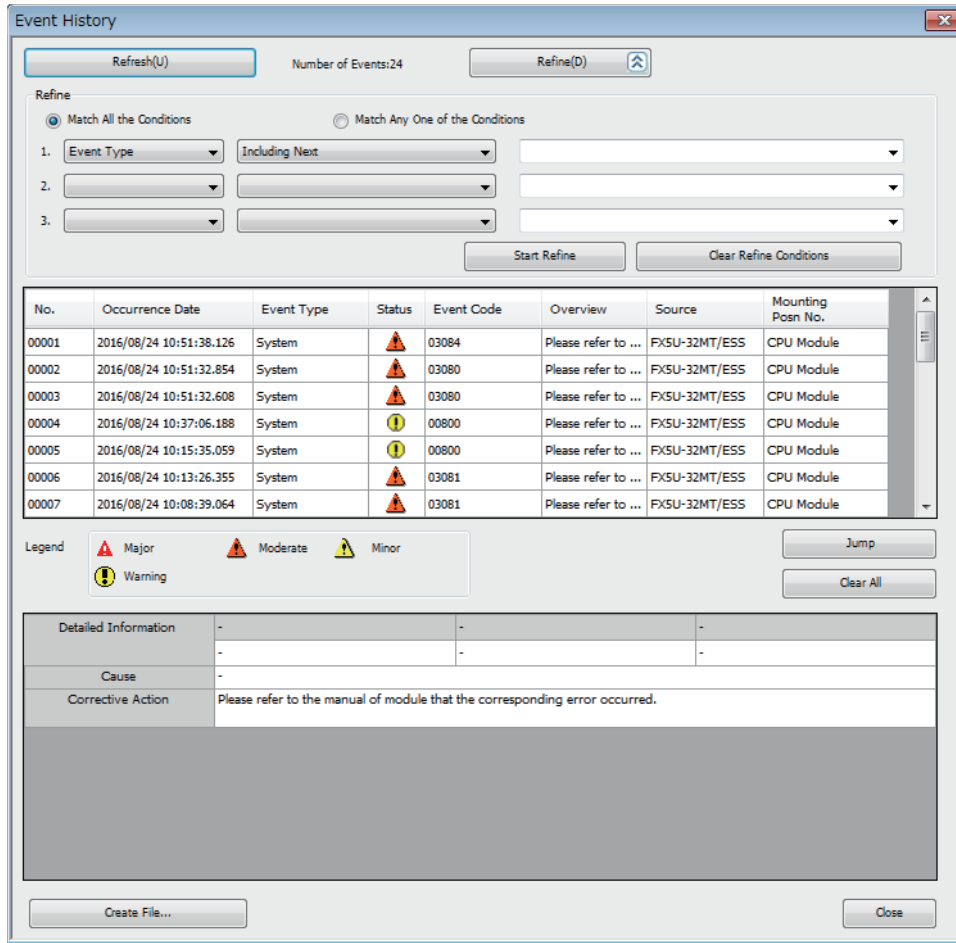

## Troubleshooting by Symptom

The following describes troubles classified by symptoms.

### Point

In the explanation for each item, the icons below indicate the applicable analog adapters. (The explanations do not apply to the analog adapters marked with ×.)



If the symptom is not improved even after the actions according to each check item are taken, the possible cause is the failure of the analog adapter. Please consult your local Mitsubishi representative.

## When the PWR LED does not turn ON

Check item	Action
Whether the power is supplied	FX5-4A-ADP, FX5-4DA-ADP • Check whether the voltage supplied to the analog adapter is within the rated range. FX5-4AD-ADP, FX5-4AD-PT-ADP, FX5-4AD-TC-ADP • Check whether the voltage supplied to the CPU module is within the rated range.
Whether the analog adapter is attached normally to the CPU module	Check the analog adapter attached status.

## Troubleshooting of analog input

FX5-4A-ADP

FX5-4AD-ADP

FX5-4DA-ADP

FX5-4AD-PT-ADP

FX5-4AD-TC-ADP

### ■If the digital output value cannot be read

Check item	Action
Whether the analog signal cable is disconnected from the analog adapter	Check the signal cables visually, and wire the analog signal cable correctly.
Whether the external equipment is wired correctly.	Correctly wire the analog adapter and the externally connected device. <ul style="list-style-type: none"> <li>• Check whether the shield wire of the channel to be used is grounded.</li> <li>• Check whether the V<math>\square</math>+ terminal and I<math>\square</math>+ terminal are connected to each other when the current is input.</li> </ul>
Whether 24VDC power is supplied to the external power supply of the analog adapter	Supply the 24VDC power to the analog adapter.
Whether the offset/gain is set correctly	Check whether the offset/gain is set correctly. Check whether A/D conversion is executed correctly. When A/D conversion is executed correctly, set the offset/gain again.
Whether the input range setting is correct	Check the input range setting in the parameter setting of GX Works3. If the contents of setting are wrong, set the input range again.
Whether the "A/D conversion enable/disable setting" is set to "disable" for the channel to be used	Check the "A/D conversion enable/disable setting" for the channel to be used in the parameter setting of GX Works3, and set "enable" in the parameter of GX Works3 or in the program.

### ■If the digital output value does not change

Check item	Action
Whether disconnection is detected	Remove the cause of the disconnection by replacing the analog signal cable or other means, and then check the digital output value.
Whether over-scale is detected.	Remove the cause of over-scale, and then check the digital output value.
Whether the shift function is working with a proper setting value	Set the conversion value shift amount suitable for the system.

### ■When a value is not converted to the expected digital output value

Check item	Action
Whether the input range setting is correct	Check the input range setting in the parameter setting of GX Works3. If the contents of setting are wrong, set the input range again.
Whether the offset/gain setting is correct	Check whether the offset/gain is set correctly. Check whether A/D conversion is executed correctly. When A/D conversion is executed correctly, set the offset/gain again.
Whether the A/D conversion method is set correctly.	Check the A/D conversion method in the parameter setting of GX Works3. If the contents of setting are wrong, set the A/D conversion method again.
Whether the scaling function is set correctly.	When the scaling function is used, check the scaling function setting in the parameter setting of GX Works3. If the contents of setting are wrong, set the scaling function again.
Whether the shift function is working with a proper setting value.	Set the conversion value shift amount suitable for the system.
Whether the power is supplied	Check whether the voltage supplied to the analog adapter is within the rated range.

### ■When the digital output value varies

Check item	Action
Whether an A/D conversion method other than sampling processing is set.	Check the A/D conversion method in the parameter setting of GX Works3. Set the averaging processing to the A/D conversion method, and then check again for dispersion of the digital output value.

### ■When the A/D conversion completed flag does not turn ON

Check item	Action
Whether all channels are set to disable A/D conversion	Check the channels for which A/D conversion is enabled in the parameter setting of GX Works3. If A/D conversion is not enabled in any channel, enable A/D conversion for 1 or more channels in the parameter of GX Works3 or in the program.
Whether disconnection is detected	Remove the cause of the disconnection by replacing the analog signal cable or other means, and then check the digital output value.

## Troubleshooting of analog output

FX5-4A-ADP

FX5-4AD-ADP

FX5-4DA-ADP

FX5-4AD-PT-ADP

FX5-4AD-TC-ADP

### ■When the analog output value is not given

Check item	Action
Whether the analog signal cable is disconnected from the analog adapter	Check the signal cables visually, and wire the analog signal cable correctly.
Whether the external equipment is wired correctly.	Correctly wire the analog adapter and the externally connected device.
Whether 24VDC power is supplied to the external power supply of the analog adapter	Supply the 24VDC power to the analog adapter.
Whether the "D/A conversion enable/disable setting" is set to "disable" for the channel to be used	Check the "D/A conversion enable/disable setting" for the channel to be used in the parameter setting of GX Works3, and set "enable" in the parameter of GX Works3 or in the program.
Whether the "D/A output enable/disable setting" is set to "disable" for the channel to be used for output	Check the "D/A output enable/disable setting" for the channel to be used in the parameter setting of GX Works3, and set "enable" in the parameter of GX Works3 or in the program.
Whether the digital value written to the desired channel for output	Check the digital value with GX Works3.

### ■When the analog output value does not change

Check item	Action
Whether the CPU module operation status is "STOP" or "STOP (by stop error)"	The analog output HOLD/CLEAR function is being executed. Set the CPU module to the "RUN" status, and check whether analog output is given normally. When an error causing stop occurs, remove the cause of the error, and then turn OFF and ON the CPU module or reset the CPU module.

### ■When a value is not converted into the expected analog output value

Check item	Action
Whether the output range is set correctly	Check the output range setting in the parameter setting of GX Works3. If the contents of setting are wrong, set the output range again.
Whether the offset/gain is set correctly	Check whether the offset/gain is set correctly. Check whether D/A conversion is executed correctly. When D/A conversion is executed correctly, set the offset/gain again.
Whether the scaling function is set correctly	When the scaling function is used, check the scaling function setting in the parameter setting of GX Works3. If the contents of setting are wrong, set the scaling function again.
Whether the shift function is working with a proper setting value	Set the input value shift amount suitable for the system.
Whether a digital value is set that exceeds the warning output upper/lower limit	When the warning output function is used, check the warning output function setting in the parameter setting of GX Works3. If there is no problem with the settings, check whether the digital value is set to a value outside the warning output range.
Whether the power is supplied	Check whether the voltage supplied to the analog adapter is within the rated range.

### ■When the analog output value cannot be held

Check item	Action
Whether the CPU module operation status is "STOP" or "STOP (by stop error)"	Check the CPU module operation status. The analog output HOLD/CLEAR function is enabled when the CPU module is in the "STOP" or "STOP (by stop error)" status.
Whether the analog output HOLD/CLEAR function is set correctly	Check the analog output HOLD/CLEAR function setting in the parameter setting of GX Works3. If the contents of setting are wrong, set the analog output HOLD/CLEAR function again.
Whether the PWR LED is off	Reset the CPU module, and check whether the PWR LED turns ON.

## Troubleshooting of temperature sensor input

FX5-4A-ADP

FX5-4AD-ADP

FX5-4DA-ADP

FX5-4AD-PT-ADP

FX5-4AD-TC-ADP

### ■When a measured temperature value cannot be read

Check item	Action
Whether the analog signal cable is disconnected from the analog adapter	Check the signal cables visually, and wire the analog signal cable correctly.
Whether the external equipment is wired correctly.	Correctly wire the analog adapter and the externally connected device.
Whether the offset/gain is set correctly	Check whether the offset/gain is set correctly. Check whether temperature conversion is executed correctly. When temperature conversion is executed correctly, set the offset/gain again.
Whether the setting resistance temperature detector type is correct	Check the setting resistance temperature detector type of GX Works3. If the contents of setting are wrong, set the resistance temperature detector type again.
Whether the setting thermocouple type is correct	Check the setting thermocouple type in the parameter setting of GX Works3. If the contents of setting are wrong, set the thermocouple type again.
Whether the "conversion enable/disable setting" is set to "disable" for the channel to be used	Check the "Conversion enable/disable setting" for the channel to be used in the parameter setting of GX Works3, and set "enable" in the parameter of GX Works3 or in the program.

### ■When the Measured temperature value does not change

Check item	Action
Whether a disconnection (outside the measurement temperature range) is detected	Remove the cause of disconnection by replacing the analog signal cable, etc., and then check the Measured temperature value.

### ■When a value is not converted into the expected digital output value

Check item	Action
Whether the setting RTD type is correct	Check the setting RTD type in the parameter setting of GX Works3. If the contents of setting are wrong, set the RTD type again.
Whether the setting thermocouple type is correct	Check the setting thermocouple type in the parameter setting of GX Works3. If the contents of setting are wrong, set the thermocouple type again.
Whether the offset/gain setting is correct	Check whether the offset/gain is set correctly. Check whether temperature conversion is executed correctly. When temperature conversion is executed correctly, set the offset/gain again.
Whether the temperature conversion method is set correctly.	Check the temperature conversion method in the parameter setting of GX Works3. If the contents of setting are wrong, set the temperature conversion method again.

### ■When the measured temperature value is dispersed

Check item	Action
Whether a temperature conversion method other than sampling processing is set.	Check the temperature conversion method in the parameter setting of GX Works3. Set the averaging processing to the temperature conversion method, and then check again for dispersion of the measured temperature value.

### ■When the conversion completed flag does not turn ON

Check item	Action
Whether all channels are set to disable conversion	Check the channels for which conversion is enabled in the parameter setting of GX Works3. If conversion is not enabled in any channel, enable conversion for 1 or more channels in the parameter of GX Works3 or in the program.
Whether a disconnection (outside the measurement temperature range) is detected	Remove the cause of disconnection by replacing the analog signal cable, etc., and then check the measured temperature value.

# APPENDIX

## Appendix 1 Special Relay List

The following table shows items in the list for special relays (SM).

Item	Description
No.	Special relay number
Name	Special relay name
Description	Data stored in the special relay and its meaning
Compatible CPU module	Shows CPU modules that support the special relay. The support status is represented by the following symbols. <ul style="list-style-type: none"> <li>○: Supported</li> <li>×: Not supported</li> </ul>
R/W	The following symbols show whether the special relay can be read/written. <ul style="list-style-type: none"> <li>R: Read-only</li> <li>W: Write-only</li> <li>R/W: Read/Write</li> </ul>

### Diagnostic information

The special relays for diagnostic information are shown below.

No.	Name	Description	Compatible CPU module			R/W
			FX5S	FX5UJ	FX5U/ FX5UC	
SM0	Latest self diagnostics error (including annunciator ON)	OFF: No error ON: Error	○	○	○	R
SM1	Latest self diagnostics error (not including annunciator On)	OFF: No self-diagnosis errors ON: Self-diagnosis error	○	○	○	R
SM50	Error reset	OFF→ON: Error reset request ON→OFF: Error reset completion	○	○	○	R/W
SM51	Battery low latch	OFF: Normal ON: Battery low	×	×	○	R
SM52	Battery low	OFF: Normal ON: Battery low	×	×	○	R
SM53	AC/DC DOWN	OFF: No AC/DC down detection ON: AC/DC down is detected	×	○	○	R
SM56	Operation error	OFF: Normal ON: Operation error	○	○	○	R
SM61	I/O module verify error	OFF: Normal ON: Error	×	○	○	R
SM62	Annunciator	OFF: Not detected ON: Detected	○	○	○	R
SM80	Detailed information 1: Flag in use	OFF: Not used ON: In use	○	○	○	R
SM112	Detailed information 2: Flag in use	OFF: Not used ON: In use	○	○	○	R

## System information

The special relays for system information are shown below.

No.	Name	Description	Compatible CPU module			R/W
			FX5S	FX5UJ	FX5U/ FX5UC	
SM203	STOP contact	OFF: Other than STOP state ON: STOP state	○	○	○	R
SM204	PAUSE contact	OFF: Other than PAUSE state ON: PAUSE state	○	○	○	R
SM210	Clock data set request	OFF→ON: Set Request ON→OFF: Set completed	○	○	○	R/W
SM211	Clock data set error	OFF: No error ON: Error	○	○	○	R
SM213	Clock data read request	OFF: Ignored ON: Read request	○	○	○	R/W

## SFC information



The following is a list of special relay areas relating to SFC information.

No.	Name	Description	Compatible CPU module			R/W
			FX5S	FX5UJ	FX5U/ FX5UC	
SM320	Presence/absence of SFC program	OFF: No SFC program ON: SFC program	○	○	○	R
SM321	Start/stop SFC program	OFF: SFC program not executed (stop) ON: SFC program executed (start)	○	○	○	R/W
SM322	SFC program startup status	OFF: Initial start ON: Resumption	○	○	○	R/W
SM323	Presence/absence of continuous transition for entire block	OFF: No continuous transition ON: Continuous transition	○	○	○	R/W
SM324	Continuous transition prevention flag	OFF: When transition executed ON: When there is no transition	○	○	○	R
SM325	Output mode at block stop	OFF: Coil output turned off ON: Coil output retained	○	○	○	R/W
SM327	Output mode at execution of the END step	OFF: Hold step output off ON: Hold step output retained	○	○	○	R/W
SM328	Clear processing mode when the sequence reaches the END step	OFF: Clear processing performed ON: Clear processing not performed	○	○	○	R
SM329	Online change (SFC block) in-execution flag	OFF: Not being executed ON: Being executed	○	○	○	R
SM4301	FX3 compatible transition operation mode setting status	OFF: Disabled ON: Enabled	○	○	○	R

A

# System clock

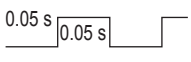
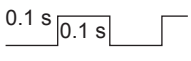
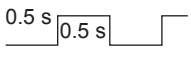
The special relay about system clock is shown below.

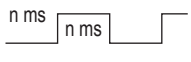
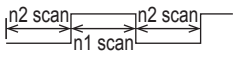
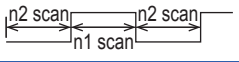
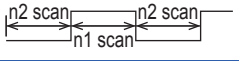
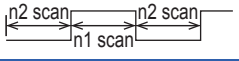
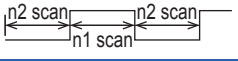
No.	Name	Description	Compatible CPU module			R/W
			FX5S	FX5UJ	FX5U/ FX5UC	
SM400	Always ON	ON _____ OFF	○	○	○	R
SM401	Always OFF	ON _____ OFF _____	○	○	○	R
SM402	After RUN, ON for one scan only	ON _____ OFF ← 1 scan	○	○	○	R
SM403	After RUN, OFF for one scan only	ON ← 1 scan OFF _____	○	○	○	R
SM409	0.01 second clock	0.005 s 	○	○	○	R
SM410	0.1 second clock	0.05 s 	○	○	○	R
SM411	0.2 second clock	0.1 s 	○	○	○	R
SM412	1 second clock	0.5 s 	○	○	○	R
SM413	2 second clock	1 s 	○	○	○	R
SM414	2n second clock	n s 	○	○	○	R
SM415	2n millisecond clock	n ms 	○	○	○	R
SM420	Timing clock output 1		○	○	○	R
SM421	Timing clock output 2		○	○	○	R
SM422	Timing clock output 3		○	○	○	R
SM423	Timing clock output 4		○	○	○	R
SM424	Timing clock output 5		○	○	○	R



## Scan information

The special relay for scan information is shown below.

No.	Name	Description	Compatible CPU module			R/W
			FX5S	FX5UJ	FX5U/ FX5UC	
SM522	Scan time clear request	OFF: Do not clear the scan time. ON: Clear the scan time.	×	○	○	R/W

## Drive information

The special relays for drive information are shown below.

No.	Name	Description	Compatible CPU module			R/W
			FX5S	FX5UJ	FX5U/ FX5UC	
SM600	SD memory card usable	OFF: Unusable ON: Usable	○	○	○	R
SM601	SD memory card protect	OFF: Not protected ON: Protected	○	○	○	R
SM603	SD memory card insertion	OFF: No drive 2 ON: Drive 2 present	○	○	○	R
SM605	SD memory card interchange protect	OFF: Remove/insert enabled ON: Remove/insert prohibited	○	○	○	R/W
SM606	Memory card disable request	OFF: Clear command ON: Command	○	○	○	R/W
SM607	Memory card disable status	OFF: Not disabled by SD memory card forced stop request ON: Disabled by SD memory card forced stop request	○	○	○	R
SM632	Data memory write error detection	OFF: Write not executed/normal ON: Write error	○	○	○	R
SM633	Data memory writing	OFF: Write not executed ON: Writing	○	○	○	R
SM634	Data memory write count error detection flag	OFF: Overwrite count is less than 20,000 ON: Overwrite count is 20,000 or more	○	○	○	R

## Instruction related

The special relays related to instruction execution are shown below.

No.	Name	Description	Compatible CPU module			R/W
			FX5S	FX5UJ	FX5U/ FX5UC	
SM699	Dedicated instruction skip flag	OFF: Intelligent dedicated instruction executed ON: Intelligent dedicated instruction not executed	○	○	○	R/W
SM700	Carry flag	OFF: Carry off ON: Carry on	○	○	○	R
SM701	Output character number switching	OFF: NULL code output ON: No change	○	○	○	R/W
SM703	Sort order	OFF: Ascending order ON: Descending order	○	○	○	R/W
SM704	Block comparison	OFF: Non-match found ON: All match	○	○	○	R
SM705	Number of conversion digits selection	OFF: Set with a specific number of digits (sign + numeric value of 5 digits) ON: Set with any number of digits (maximum: sign + numeric value of 5 digits)	○	○	○	R/W
SM709	DT/TM instruction improper data detection	OFF: Improper data not detected ON: Improper data detected	○	○	○	R/W
SM753	File being accessed	OFF: Not in progress ON: In progress	○	○	○	R

## Firmware update function

The special relays for firmware update function are shown below.

No.	Name	Description	Compatible CPU module			R/W
			FX5S	FX5UJ	FX5U/ FX5UC	
SM912	Firmware update prohibit state	OFF: Firmware update enable state ON: Firmware update prohibit state (Firmware update prohibited file is present)	○	○	○	R

## Latch area

The special relays for latch area are shown below.

No.	Name	Description	Compatible CPU module			R/W
			FX5S	FX5UJ	FX5U/ FX5UC	
SM953	Data backup error check flag	OFF: No error ON: Error	○	○	○	R
SM959	Data restoration error check flag	OFF: No error ON: Error	○	○	○	R
SM9353	Clear/keep of latch label during PC write	OFF: Clear ON: Keep	○	○	○	R/W

# Data logging function

The special relays for data logging function are shown below.

No.	Name	Description	Compatible CPU module			R/W
			FX5S	FX5UJ	FX5U/ FX5UC	
SM1201	SD memory card setting file in use flag	OFF: Not used ON: In use	○	○	○	R
SM1202	Data memory setting file in use flag	OFF: Not used ON: In use	○	○	○	R
SM1203	Data logging file transfer stop request	This special relay stops the logging file transfer with the value specified in SD1203 when this relay is changed from with off to on. It turns off when the logging file transfer is stopped. OFF: Transfer stopped ON: Stop requested	○	○	○	R/W
SM1210	Data logging setting No.1 Data logging preparation	OFF: Not prepared ON: Prepared	○	○	○	R
SM1211	Data logging setting No.1 Data logging start	OFF: Suspended/waiting for start ON: Start	○	○	○	R
SM1212	Data logging setting No.1 Data logging data collection in progress	OFF: Not in progress ON: In progress	○	○	○	R
SM1213	Data logging setting No.1 Data logging completion	OFF: Not completed ON: Completed	○	○	○	R
SM1214	Data logging setting No.1 Data logging triggering	OFF→ON: Triggered	○	○	○	R
SM1215	Data logging setting No.1 Post data logging triggering	OFF: Not post triggering ON: Post triggering	○	○	○	R
SM1216	Data logging setting No.1 Data logging error	OFF: No error ON: Error	○	○	○	R
SM1217	Data logging setting No.1 Data logging data saving into SD memory card in progress	OFF: Not in progress ON: In progress	○	○	○	R
SM1218	Data logging setting No.1 Logging data storage file switching in progress	OFF: Not in progress ON: In progress	○	○	○	R
SM1219	Data logging setting No.1 Logging file transfer function execution status flag	OFF: Not executed ON: Executed	○	○	○	R
SM1220 to SM1229	Data logging setting No.2	Same configuration as the setting No.1	○	○	○	R
SM1230 to SM1239	Data logging setting No.3	Same configuration as the setting No.1	○	○	○	R
SM1240 to SM1249	Data logging setting No.4	Same configuration as the setting No.1	○	○	○	R
SM1312 to SM1315	Data logging setting No.1 to 4 Data logging suspend/resume flag	OFF→ON: Suspend ON→OFF: Resume	○	○	○	R/W
SM9300 to SM9303	Data logging setting No.1 to 4 Data logging register/clear flag	OFF: Clear ON: Register	○	○	○	R/W



## Data backup/restoration function

The special relays for data backup/restoration function are shown below.

No.	Name	Description	Compatible CPU module			R/W
			FX5S	FX5UJ	FX5U/ FX5UC	
SM1350	Data backup status flag	OFF: Not being executed ON: Being executed	○	○	○	R
SM1351	Data backup execution request	OFF→ON: Backup requested ON→OFF: Backup completed	○	○	○	R/W
SM1353	Data restoration status flag	OFF: Not being executed ON: Being executed	○	○	○	R
SM1354	Data restoration execution request	OFF→ON: Restoration requested ON→OFF: Restoration completed	○	○	○	R/W
SM9350	CPU module auto exchange function enable/disable flag	OFF: Enable ON: Disable	○	○	○	R/W

## File transfer function (FTP client)

The special relay for file transfer function (FTP client) is shown below.

No.	Name	Description	Compatible CPU module			R/W
			FX5S	FX5UJ	FX5U/ FX5UC	
SM1392	FTP client connection status	OFF: Not connected (disconnected) ON: Connected	○	○	○	R

## Memory dump function

The special relays for memory dump function are shown below.

No.	Name	Description	Compatible CPU module			R/W
			FX5S	FX5UJ	FX5U/ FX5UC	
SM1472	Memory dump in progress	OFF: Memory dump not executed ON: Memory dump in progress	○	○	○	R
SM1473	Memory dump completed	OFF: Not completed ON: Completed	○	○	○	R

## CC-Link IE Field Network Basic function

The special relays for CC-Link IE Field Network Basic function are shown below.

No.	Name	Description	Compatible CPU module			R/W
			FX5S	FX5UJ	FX5U/ FX5UC	
SM1536	Cyclic transmission status	OFF: Not performed ON: Being performed	○	○	○	R
SM1540	Data link status	OFF: All stations normal ON: One or more faulty stations	○	○	○	R
SM9400	CC-Link IE Field Network Basic communication interval setting enable/disable flag (Setting value)	OFF: Disabled ON: Enabled	○	○	○	R/W
SM9401	CC-Link IE Field Network Basic communication interval setting enable/disable flag (Current value)	OFF: Disabled ON: Enabled	○	○	○	R

# High-speed input/output function

The special relays for the high-speed input/output function are shown below.

## Shared for all channels of the CPU module

No.	Name	Description	Compatible CPU module			R/W
			FX5S	FX5UJ	FX5U/ FX5UC	
SM4210	All module reset command	OFF: Disabled ON: Enabled (when SD4210 stores F5F5H)	×	○	○	R/W
SM4300	Event execution type program operation timing switch setting	OFF: Can be executed after initial execution type program operation ON: Can be executed in the same scan as initial execution type program operation	○	○	○	R/W
SM4493	File access adjustment setting	OFF: Disabled ON: Enabled	×	×	○	R/W
SM4496	Intelligent module latest error clear request	OFF: Error reset not requested ON: Error reset completion	×	○	○	R/W
SM5000	High-speed counter multi-point output high-speed comparison table operating	OFF: Stopped ON: Operation	○	○	○	R
SM5001	High-speed counter multi-point output high-speed comparison table completion	OFF: Not completed ON: Completion	○	○	○	R/W

## CPU module

### • High-speed counter

No. CH1 to CH8	Name	Description	Compatible CPU module			R/W
			FX5S	FX5UJ	FX5U/ FX5UC	
SM4500 to SM4507	High-speed counter operating	OFF: Stopped ON: Operation	○	○	○	R
SM4516 to SM4523	High-speed counter pulse density/rotational speed being measured	OFF: Stopped ON: Measurement	○	○	○	R
SM4532 to SM4539	High-speed counter overflow occurrence	OFF: No error ON: Overflow	○	○	○	R/W
SM4548 to SM4555	High-speed counter underflow occurrence	OFF: No error ON: Underflow	○	○	○	R/W
SM4564 to SM4571	High-speed counter count direction monitor	OFF: Up-counting ON: Down-counting	○	○	○	R
SM4580 to SM4587	High-speed counter (1-phase 1-input S/W) count direction switch	OFF: Up-counting ON: Down-counting	○	○	○	R/W
SM4596 to SM4603	High-speed counter preset input logic	OFF: Positive logic ON: Negative logic	○	○	○	R/W
SM4612 to SM4619	High-speed counter preset input comparison enable	OFF: Disabled ON: Enabled	○	○	○	R/W
SM4628 to SM4635	High-speed counter enable input logic	OFF: Positive logic ON: Negative logic	○	○	○	R/W
SM4644 to SM4651	High-speed counter ring length setting	OFF: Disabled ON: Enabled	○	○	○	R/W
SM4980	High-speed counter high-speed comparison table operating	OFF: Stopped ON: Operation	○	○	○	R
SM4982	High-speed counter high-speed comparison table error occurrence	OFF: No error ON: Error	○	○	○	R/W

A

• Pulse width measurement

No. CH1 to CH4	Name	Description	Compatible CPU module			R/W
			FX5S	FX5UJ	FX5U/ FX5UC	
SM5020 to SM5023	Pulse width measurement operation	The measurement in progress/measurement stopped status of pulse width measurement on the target channel can be checked by these flags. OFF: Stopped ON: Operation	○	○	○	R
SM5036 to SM5039	Period measurement complete	These flags turn ON at the end of the 1st period measurement on the target channel. (They remain ON during measurement in the always measurement mode.) OFF: Cycle measurement not completed ON: Cycle measurement completion	○	○	○	R
SM5052 to SM5055	Pulse width measurement complete	These flags turn ON at the end of the 1st pulse width measurement on the target channel. (They remain ON during measurement in the always measurement mode.) OFF: Pulse width measurement not completed ON: Pulse width measurement completion	○	○	○	R
SM5068 to SM5071	Pulse width measurement mode	The measurement mode of the target channel can be checked by these flags. (To change the measurement mode during operation, use this special relay.) OFF: Always measurement mode ON: 1 time measurement mode	○	○	○	R/W

• PWM

No. CH1 to CH4	Name	Description	Compatible CPU module			R/W
			FX5S	FX5UJ	FX5U/ FX5UC	
SM5300 to SM5303	PWM pulse output monitor	The operation/stopped status of PWM output on the target channel can be checked. OFF: Stopped ON: Operation	○	○	○	R
SM5316 to SM5319	PWM output normal end flag	The end status of PWM output on the target channel can be checked. OFF: Other than normally end ON: Normally end	○	○	○	R/W
SM5332 to SM5335	PWM output abnormal end flag	The end status of PWM output on the target channel can be checked. OFF: No error ON: Abnormal end	○	○	○	R/W

• Positioning

No. Axis 1 to Axis 4	Name	Description	Compatible CPU module			R/W
			FX5S	FX5UJ*1	FX5U/ FX5UC	
SM5500 to SM5503	Positioning instruction activation	OFF: Stopped ON: Operation	○	○	○	R
SM5516 to SM5519	Positioning pulse output monitor	OFF: Stopped ON: Pulse output	○	○	○	R
SM5532 to SM5535	Positioning error occurrence	OFF: No error ON: Error	○	○	○	R/W
SM5580 to SM5583	Positioning table shift command	OFF: No table shift ON: Table shift start	○	○	○	R/W
SM5596 to SM5599	Positioning remaining distance operation enabled	OFF: Remaining distance operation disabled ON: Remaining distance operation enabled	○	○	○	R/W
SM5612 to SM5615	Positioning remaining distance operation command	OFF: Remaining distance operation standby ON: Remaining distance operation start	○	○	○	R/W
SM5628 to SM5631	Positioning pulse output stop command	OFF: Pulse output is not stopped ON: Pulse output immediate stop	○	○	○	R/W
SM5644 to SM5647	Positioning pulse decelerates stop command (With remaining distance operation)	OFF: Pulse output is not stopped ON: Pulse output decelerates stop	○	○	○	R/W
SM5660 to SM5663	Positioning forward rotation limit	OFF: Forward rotation limit off ON: Forward rotation limit on	○	○	○	R/W
SM5676 to SM5679	Positioning reverse rotation limit	OFF: Reverse rotation limit off ON: Reverse rotation limit on	○	○	○	R/W
SM5772 to SM5775	Positioning rotation direction specification	OFF: Forward rotation (Current address increases) ON: Reverse rotation (Current address increases)	○	○	○	R/W
SM5804 to SM5807	Positioning zero return direction specification	OFF: Zero return start (Reverse rotation direction) ON: Zero return start (Forward rotation direction)	○	○	○	R/W
SM5820 to SM5823	Positioning clear signal output enable	OFF: Clear signal disabled ON: Clear signal enabled	○	○	○	R/W
SM5868 to SM5871	Positioning zero signal count start time	OFF: Near point DOG backward end ON: Near point DOG forward end	○	○	○	R/W
SM5916 to SM5919	Positioning table data initialization disable	OFF: Disabled ON: Enabled	○	○	○	R/W

\*1 Only Axis 1 to Axis 3 are supported.



## High-speed pulse input/output module

### • High-speed counter

No. CH9 to CH16	Name	Description	Compatible CPU module			R/W
			FX5S	FX5UJ	FX5U/ FX5UC	
SM4508 to SM4515	High-speed counter operating	OFF: Stopped ON: Operation	×	○	○	R
SM4540 to SM4547	High-speed counter overflow occurrence	OFF: No error ON: Overflow	×	○	○	R/W
SM4556 to SM4563	High-speed counter underflow occurrence	OFF: No error ON: Underflow	×	○	○	R/W
SM4572 to SM4579	High-speed counter count direction monitor	OFF: Up-counting ON: Down-counting	×	○	○	R
SM4588 to SM4595	High-speed counter (1-phase 1-input S/W) count direction switch	OFF: Up-counting ON: Down-counting	×	○	○	R/W
SM4604 to SM4611	High-speed counter preset input logic	OFF: Positive logic ON: Negative logic	×	○	○	R/W
SM4620 to SM4627	High-speed counter preset input comparison enable	OFF: Disabled ON: Enabled	×	○	○	R/W
SM4636 to SM4643	High-speed counter enable input logic	OFF: Positive logic ON: Negative logic	×	○	○	R/W
SM4652 to SM4659	High-speed counter ring length setting	OFF: Disabled ON: Enabled	×	○	○	R/W
SM4984, SM4988, SM4992, SM4996	High-speed counter high-speed comparison table operating	OFF: Stopped ON: Operation	×	○	○	R
SM4986, SM4990, SM4994, SM4998	High-speed counter high-speed comparison table error occurrence	OFF: No error ON: Error	×	○	○	R/W

### • Pulse width measurement

No. CH5 to CH12	Name	Description	Compatible CPU module			R/W
			FX5S	FX5UJ	FX5U/ FX5UC	
SM5024 to SM5031	Pulse width measurement operation	The measurement in progress/measurement stopped status of pulse width measurement on the target channel can be checked by these flags. OFF: Stopped ON: Operation	×	○	○	R
SM5040 to SM5047	Period measurement complete	These flags turn ON at the end of the 1st period measurement on the target channel. (They remain ON during measurement in the always measurement mode.) OFF: Cycle measurement not completed ON: Cycle measurement completion	×	○	○	R
SM5056 to SM5063	Pulse width measurement complete	These flags turn ON at the end of the 1st pulse width measurement on the target channel. (They remain ON during measurement in the always measurement mode.) OFF: Pulse width measurement not completed ON: Pulse width measurement completion	×	○	○	R
SM5072 to SM5079	Pulse width measurement mode	The measurement mode of the target channel can be checked by these flags. (To change the measurement mode during operation, use this special relay.) OFF: Always measurement mode ON: 1 time measurement mode	×	○	○	R/W



• PWM

No. CH5 to CH12	Name	Description	Compatible CPU module			R/W
			FX5S	FX5UJ	FX5U/ FX5UC	
SM5304 to SM5311	PWM pulse output monitor	The operation/stopped status of PWM output on the target channel can be checked. OFF: Stopped ON: Operation	×	○	○	R
SM5320 to SM5327	PWM output normal end flag	The end status of PWM output on the target channel can be checked. OFF: Other than normally end ON: Normally end	×	○	○	R/W
SM5336 to SM5343	PWM output abnormal end flag	The end status of PWM output on the target channel can be checked. OFF: No error ON: Abnormal end	×	○	○	R/W

• Positioning

No. Axes 5 to 12	Name	Description	Compatible CPU module			R/W
			FX5S	FX5UJ	FX5U/ FX5UC	
SM5504 to SM5511	Positioning instruction activation	OFF: Stopped ON: Operation	×	○	○	R
SM5520 to SM5527	Positioning pulse output monitor	OFF: Stopped ON: Pulse output	×	○	○	R
SM5536 to SM5543	Positioning error occurrence	OFF: No error ON: Error	×	○	○	R/W
SM5584 to SM5591	Positioning table shift command	OFF: No table shift ON: Table shift start	×	○	○	R/W
SM5600 to SM5607	Positioning remaining distance operation enabled	OFF: Remaining distance operation disabled ON: Remaining distance operation enabled	×	○	○	R/W
SM5616 to SM5623	Positioning remaining distance operation command	OFF: Remaining distance operation standby ON: Remaining distance operation start	×	○	○	R/W
SM5632 to SM5639	Positioning pulse output stop command	OFF: Pulse output is not stopped ON: Pulse output immediate stop	×	○	○	R/W
SM5648 to SM5655	Positioning pulse decelerates stop command (With remaining distance operation)	OFF: Pulse output is not stopped ON: Pulse output decelerates stop	×	○	○	R/W
SM5664 to SM5671	Positioning forward rotation limit	OFF: Forward rotation limit off ON: Forward rotation limit on	×	○	○	R/W
SM5680 to SM5687	Positioning reverse rotation limit	OFF: Reverse rotation limit off ON: Reverse rotation limit on	×	○	○	R/W
SM5776 to SM5783	Positioning rotation direction specification	OFF: Forward rotation (Current address increases) ON: Reverse rotation (Current address increases)	×	○	○	R/W
SM5808 to SM5815	Positioning zero return direction specification	OFF: Zero return start (Reverse rotation direction) ON: Zero return start (Forward rotation direction)	×	○	○	R/W
SM5824 to SM5831	Positioning clear signal output enable	OFF: Clear signal disabled ON: Clear signal enabled	×	○	○	R/W
SM5872 to SM5879	Positioning zero signal count start time	OFF: Near point DOG backward end ON: Near point DOG forward end	×	○	○	R/W
SM5920 to SM5927	Positioning table data initialization disable	OFF: Disabled ON: Enabled	×	○	○	R/W



# CPU module built-in analog function

Only FX5U CPU module is supported.

The special relays for the CPU module built-in analog function are shown below.

## Analog input

No. CH1, CH2	Name	Description	Compatible CPU module			R/W
			FX5S	FX5UJ	FX5U/ FX5UC*1	
SM6020, SM6060	A/D conversion completed flag	OFF: A/D conversion not completed ON: A/D conversion completed	×	×	○	R
SM6021, SM6061	A/D conversion enable/disable setting	OFF: A/D conversion enable ON: A/D conversion disable	×	×	○	R/W
SM6022, SM6062	Over scale upper limit detection flag	OFF: No over scaling ON: Over scaling	×	×	○	R
SM6023, SM6063	Over scale lower limit detection flag	OFF: No over scaling ON: Over scaling	×	×	○	R
SM6024, SM6064	Over scale detection setting	OFF: Enabled ON: Disabled	×	×	○	R/W
SM6025, SM6065	Maximum value/minimum value reset completed flag	OFF: Reset not completed ON: Reset completed	×	×	○	R
SM6026, SM6066	Maximum value reset request	OFF: No reset request ON: Reset request	×	×	○	R/W
SM6027, SM6067	Minimum value reset request	OFF: No reset request ON: Reset request	×	×	○	R/W
SM6028, SM6068	Scaling enable/disable setting	OFF: Enabled ON: Disabled	×	×	○	R/W
SM6029, SM6069	Digital clipping enable/disable setting	OFF: Enabled ON: Disabled	×	×	○	R/W
SM6031, SM6071	Warning output flag process alarm upper limit	OFF: No alarm ON: Alarm	×	×	○	R
SM6032, SM6072	Warning output flag process alarm lower limit	OFF: No alarm ON: Alarm	×	×	○	R
SM6033, SM6073	Warning output setting (process alarm)	OFF: Enabled ON: Disabled	×	×	○	R/W
SM6057, SM6097	A/D alarm clear request	OFF: No clear request ON: Clear request	×	×	○	R/W
SM6058, SM6098	A/D alarm flag	OFF: No alarm ON: Alarm	×	×	○	R
SM6059, SM6099	A/D error flag	OFF: No error ON: Error	×	×	○	R

\*1 Only FX5U CPU module is supported.

## Analog output

No.	Name	Description	Compatible CPU module			R/W
			FX5S	FX5UJ	FX5U/ FX5UC*1	
SM6180	D/A conversion enable/disable setting	OFF: D/A conversion enable ON: D/A conversion disable	×	×	○	R/W
SM6181	D/A output enable/disable setting	OFF: Output enable ON: Output disable	×	×	○	R/W
SM6188	Scaling enable/disable setting	OFF: Enabled ON: Disabled	×	×	○	R/W
SM6191	Warning output upper limit value flag	OFF: No alarm ON: Alarm	×	×	○	R
SM6192	Warning output lower limit value flag	OFF: No alarm ON: Alarm	×	×	○	R
SM6193	Warning output setting	OFF: Disabled ON: Enabled	×	×	○	R/W
SM6217	D/A alarm clear request	OFF: No clear request ON: Clear request	×	×	○	R/W
SM6218	D/A alarm flag	OFF: No alarm ON: Alarm	×	×	○	R
SM6219	D/A error flag	OFF: No error ON: Error	×	×	○	R

\*1 Only FX5U CPU module is supported.

## Analog adapter

Only the FX5S, FX5U, and FX5UC CPU modules support the 3rd and 4th special relay areas.

The special relay areas for analog adapters are shown below.

No. CH1, CH2, CH3, CH4	Connection order	Name	Description	Compatible CPU module			R/W
				FX5S	FX5UJ	FX5U/ FX5UC	
SM6280	1st adapter	Temperature unit setting	Set the unit of temperature to use.	○	○	○	R/W
SM6640	2nd adapter						
SM7000	3rd adapter						
SM7360	4th adapter						
SM6300, SM6340, SM6380, SM6420	1st adapter	A/D conversion completed flag	This flag monitors the A/D conversion status. Target:FX5-4A-ADP (CH1, CH2), FX5-4AD-ADP	○	○	○	R
SM6660, SM6700, SM6740, SM6780	2nd adapter						
SM7020, SM7060, SM7100, SM7140	3rd adapter						
SM7380, SM7420, SM7460, SM7500	4th adapter						
SM6300, SM6340, SM6380, SM6420	1st adapter	D/A conversion enable/disable setting	Set whether to enable or disable D/A conversion. Target:FX5-4A-ADP (CH3, CH4), FX5-4DA-ADP	○	○	○	R
SM6660, SM6700, SM6740, SM6780	2nd adapter						
SM7020, SM7060, SM7100, SM7140	3rd adapter						
SM7380, SM7420, SM7460, SM7500	4th adapter						
SM6300, SM6340, SM6380, SM6420	1st adapter	Conversion completed flag	This flag monitors the temperature conversion status. Target:FX5-4AD-PT-ADP, FX5-4AD-TC-ADP	○	○	○	R
SM6660, SM6700, SM6740, SM6780	2nd adapter						
SM7020, SM7060, SM7100, SM7140	3rd adapter						
SM7380, SM7420, SM7460, SM7500	4th adapter						

A

No. CH1, CH2, CH3, CH4	Connection order	Name	Description	Compatible CPU module			R/W
				FX5S	FX5UJ	FX5U/ FX5UC	
SM6301, SM6341, SM6381, SM6421	1st adapter	A/D conversion enable/disable setting	Set whether to enable or disable A/D conversion. Target:FX5-4A-ADP (CH1, CH2), FX5-4AD-ADP	○	○	○	R/W
SM6661, SM6701, SM6741, SM6781	2nd adapter						
SM7021, SM7061, SM7101, SM7141	3rd adapter						
SM7381, SM7421, SM7461, SM7501	4th adapter						
SM6301, SM6341, SM6381, SM6421	1st adapter	D/A output enable/ disable setting	Set whether to output the D/A conversion value or to output the offset value. Target:FX5-4A-ADP (CH3, CH4), FX5-4DA-ADP	○	○	○	R/W
SM6661, SM6701, SM6741, SM6781	2nd adapter						
SM7021, SM7061, SM7101, SM7141	3rd adapter						
SM7381, SM7421, SM7461, SM7501	4th adapter						
SM6301, SM6341, SM6381, SM6421	1st adapter	Conversion enable/ disable setting	Set whether to enable or disable temperature conversion. Target:FX5-4AD-PT-ADP, FX5-4AD-TC-ADP	○	○	○	R/W
SM6661, SM6701, SM6741, SM6781	2nd adapter						
SM7021, SM7061, SM7101, SM7141	3rd adapter						
SM7381, SM7421, SM7461, SM7501	4th adapter						
SM6302, SM6342, SM6382, SM6422	1st adapter	Over scale upper limit detection flag	This flag monitors the over-scale upper limit detection status in the over-scale detection function.	○	○	○	R
SM6662, SM6702, SM6742, SM6782	2nd adapter						
SM7022, SM7062, SM7102, SM7142	3rd adapter						
SM7382, SM7422, SM7462, SM7502	4th adapter						
SM6303, SM6343, SM6383, SM6423	1st adapter	Over scale lower limit detection flag	This flag monitors the over-scale lower limit detection status in the over-scale detection function.	○	○	○	R
SM6663, SM6703, SM6743, SM6783	2nd adapter						
SM7023, SM7063, SM7103, SM7143	3rd adapter						
SM7383, SM7423, SM7463, SM7503	4th adapter						
SM6304, SM6344, SM6384, SM6424	1st adapter	Over scale detection enable/ disable setting	Set whether to enable or disable over scale detection.	○	○	○	R/W
SM6664, SM6704, SM6744, SM6784	2nd adapter						
SM7024, SM7064, SM7104, SM7144	3rd adapter						
SM7384, SM7424, SM7464, SM7504	4th adapter						
SM6305, SM6345, SM6385, SM6425	1st adapter	Maximum value/ minimum value reset completed flag	This flag monitors the "maximum value/minimum value" reset status.	○	○	○	R
SM6665, SM6705, SM6745, SM6785	2nd adapter						
SM7025, SM7065, SM7105, SM7145	3rd adapter						
SM7385, SM7425, SM7465, SM7505	4th adapter						

No. CH1, CH2, CH3, CH4	Connection order	Name	Description	Compatible CPU module			R/W
				FX5S	FX5UJ	FX5U/ FX5UC	
SM6306, SM6346, SM6386, SM6426	1st adapter	Maximum value reset request	When "maximum value reset request" is set from OFF to ON, the maximum value is updated to "digital operation value".	○	○	○	R/W
SM6666, SM6706, SM6746, SM6786	2nd adapter						
SM7026, SM7066, SM7106, SM7146	3rd adapter						
SM7386, SM7426, SM7466, SM7506	4th adapter						
SM6307, SM6347, SM6387, SM6427	1st adapter	Minimum value reset request	When "minimum value reset request" is set from OFF to ON, the minimum value is updated to "digital operation value".	○	○	○	R/W
SM6667, SM6707, SM6747, SM6787	2nd adapter						
SM7027, SM7067, SM7107, SM7147	3rd adapter						
SM7387, SM7427, SM7467, SM7507	4th adapter						
SM6308, SM6348, SM6388, SM6428	1st adapter	Scaling enable/ disable setting	Set whether to enable or disable the scaling function.	○	○	○	R/W
SM6668, SM6708, SM6748, SM6788	2nd adapter						
SM7028, SM7068, SM7108, SM7148	3rd adapter						
SM7388, SM7428, SM7468, SM7508	4th adapter						
SM6309, SM6349, SM6389, SM6429	1st adapter	Digital clipping enable/disable setting	Set whether to enable or disable the digital clipping function.	○	○	○	R/W
SM6669, SM6709, SM6749, SM6789	2nd adapter						
SM7029, SM7069, SM7109, SM7149	3rd adapter						
SM7389, SM7429, SM7469, SM7509	4th adapter						
SM6311, SM6351, SM6391, SM6431	1st adapter	Warning output flag (process alarm upper limit)	This flag monitors the upper limit value warning in the process alarm. Target:FX5-4A-ADP (CH1, CH2), FX5-4AD-ADP, FX5-4AD-PT-ADP, FX5-4AD-TC-ADP	○	○	○	R
SM6671, SM6711, SM6751, SM6791	2nd adapter						
SM7031, SM7071, SM7111, SM7151	3rd adapter						
SM7391, SM7431, SM7471, SM7511	4th adapter						
SM6311, SM6351, SM6391, SM6431	1st adapter	Warning output upper limit value flag	This flag monitors the upper limit value warning in the warning output. Target:FX5-4A-ADP (CH3, CH4), FX5-4DA-ADP	○	○	○	R
SM6671, SM6711, SM6751, SM6791	2nd adapter						
SM7031, SM7071, SM7111, SM7151	3rd adapter						
SM7391, SM7431, SM7471, SM7511	4th adapter						
SM6312, SM6352, SM6392, SM6432	1st adapter	Warning output flag (process alarm lower limit)	This flag monitors the lower limit value warning in the process alarm. Target:FX5-4A-ADP (CH1, CH2), FX5-4AD-ADP, FX5-4AD-PT-ADP, FX5-4AD-TC-ADP	○	○	○	R
SM6672, SM6712, SM6752, SM6792	2nd adapter						
SM7032, SM7072, SM7112, SM7152	3rd adapter						
SM7392, SM7432, SM7472, SM7512	4th adapter						

No. CH1, CH2, CH3, CH4	Connection order	Name	Description	Compatible CPU module			R/W
				FX5S	FX5UJ	FX5U/ FX5UC	
SM6312, SM6352, SM6392, SM6432	1st adapter	Warning output lower limit value flag	This flag monitors the lower limit value warning in the warning output. Target:FX5-4A-ADP (CH3, CH4), FX5-4DA-ADP	○	○	○	R
SM6672, SM6712, SM6752, SM6792	2nd adapter						
SM7032, SM7072, SM7112, SM7152	3rd adapter						
SM7392, SM7432, SM7472, SM7512	4th adapter						
SM6313, SM6353, SM6393, SM6433	1st adapter	Warning output setting (process alarm)	Set whether to enable or disable the warning output of process alarm.	○	○	○	R/W
SM6673, SM6713, SM6753, SM6793	2nd adapter						
SM7033, SM7073, SM7113, SM7153	3rd adapter						
SM7393, SM7433, SM7473, SM7513	4th adapter						
SM6313, SM6353, SM6393, SM6433	1st adapter	Warning output setting	Set whether to enable or disable the warning output.	○	○	○	R/W
SM6673, SM6713, SM6753, SM6793	2nd adapter						
SM7033, SM7073, SM7113, SM7153	3rd adapter						
SM7393, SM7433, SM7473, SM7513	4th adapter						
SM6315, SM6355, SM6395, SM6435	1st adapter	Warning output flag (rate alarm upper limit)	This flag monitors the upper limit value warning in the rate alarm.	○	○	○	R
SM6675, SM6715, SM6755, SM6795	2nd adapter						
SM7035, SM7075, SM7115, SM7155	3rd adapter						
SM7395, SM7435, SM7475, SM7515	4th adapter						
SM6316, SM6356, SM6396, SM6436	1st adapter	Warning output flag (rate alarm lower limit)	This flag monitors the lower limit value warning in the rate alarm.	○	○	○	R
SM6676, SM6716, SM6756, SM6796	2nd adapter						
SM7036, SM7076, SM7116, SM7156	3rd adapter						
SM7396, SM7436, SM7476, SM7516	4th adapter						
SM6317, SM6357, SM6397, SM6437	1st adapter	Warning output setting (rate alarm)	Set whether to enable or disable the warning output of rate alarm.	○	○	○	R/W
SM6677, SM6717, SM6757, SM6797	2nd adapter						
SM7037, SM7077, SM7117, SM7157	3rd adapter						
SM7397, SM7437, SM7477, SM7517	4th adapter						
SM6318, SM6358, SM6398, SM6438	1st adapter	Disconnection detection flag	This flag monitors the disconnection detection. Target:FX5-4A-ADP, FX5-4AD-ADP, FX5-4DA-ADP	○	○	○	R
SM6678, SM6718, SM6758, SM6798	2nd adapter						
SM7038, SM7078, SM7118, SM7158	3rd adapter						
SM7398, SM7438, SM7478, SM7518	4th adapter						

No. CH1, CH2, CH3, CH4	Connection order	Name	Description	Compatible CPU module			R/W
				FX5S	FX5UJ	FX5U/ FX5UC	
SM6318, SM6358, SM6398, SM6438	1st adapter	Disconnection detection flag	This flag monitors the disconnection detection. Target:FX5-4AD-PT-ADP, FX5-4AD-TC-ADP	○	○	○	R
SM6678, SM6718, SM6758, SM6798	2nd adapter						
SM7038, SM7078, SM7118, SM7158	3rd adapter						
SM7398, SM7438, SM7478, SM7518	4th adapter						
SM6319, SM6359, SM6399, SM6439	1st adapter	Disconnection detection enable/ disable setting	Set whether to enable or disable the disconnection detection function. Target:FX5-4A-ADP, FX5-4AD-ADP, FX5-4DA-ADP	○	○	○	R/W
SM6679, SM6719, SM6759, SM6799	2nd adapter						
SM7039, SM7079, SM7119, SM7159	3rd adapter						
SM7399, SM7439, SM7479, SM7519	4th adapter						
SM6319, SM6359, SM6399, SM6439	1st adapter	Disconnection detection enable/ disable setting	Set whether to enable or disable the disconnection detection function. Target:FX5-4AD-PT-ADP, FX5-4AD-TC-ADP	○	○	○	R/W
SM6679, SM6719, SM6759, SM6799	2nd adapter						
SM7039, SM7079, SM7119, SM7159	3rd adapter						
SM7399, SM7439, SM7479, SM7519	4th adapter						
SM6320, SM6360, SM6400, SM6440	1st adapter	Disconnection recovery detection enable/disable setting	Set whether to enable or disable the disconnection detection recovery. Target:FX5-4A-ADP, FX5-4AD-ADP, FX5-4DA-ADP	○	○	○	R/W
SM6680, SM6720, SM6760, SM6800	2nd adapter						
SM7040, SM7080, SM7120, SM7160	3rd adapter						
SM7400, SM7440, SM7480, SM7520	4th adapter						
SM6320, SM6360, SM6400, SM6440	1st adapter	Disconnection detection automatic clear enable/ disable setting	Set whether to enable or disable the disconnection detection automatic clear. Target:FX5-4AD-PT-ADP, FX5-4AD-TC-ADP	○	○	○	R/W
SM6680, SM6720, SM6760, SM6800	2nd adapter						
SM7040, SM7080, SM7120, SM7160	3rd adapter						
SM7400, SM7440, SM7480, SM7520	4th adapter						
SM6321, SM6361, SM6401, SM6441	1st adapter	Convergence detection flag	This flag monitors the convergence detection.	○	○	○	R
SM6681, SM6721, SM6761, SM6801	2nd adapter						
SM7041, SM7081, SM7121, SM7161	3rd adapter						
SM7401, SM7441, SM7481, SM7521	4th adapter						
SM6322, SM6362, SM6402, SM6442	1st adapter	Convergence detection enable/ disable setting	Set whether to enable or disable the convergence detection.	○	○	○	R/W
SM6682, SM6722, SM6762, SM6802	2nd adapter						
SM7042, SM7082, SM7122, SM7162	3rd adapter						
SM7402, SM7442, SM7482, SM7522	4th adapter						



No. CH1, CH2, CH3, CH4	Connection order	Name	Description	Compatible CPU module			R/W
				FX5S	FX5UJ	FX5U/ FX5UC	
SM6325, SM6365, SM6405, SM6445	1st adapter	Deviation detection flag between channel	This flag monitors the deviation detection flag between channel.	○	○	○	R
SM6685, SM6725, SM6765, SM6805	2nd adapter						
SM7045, SM7085, SM7125, SM7165	3rd adapter						
SM7405, SM7445, SM7485, SM7525	4th adapter						
SM6326, SM6366, SM6406, SM6446	1st adapter	Deviation detection trigger between channels	Set whether to enable or disable the deviation detection between channels.	○	○	○	R/W
SM6686, SM6726, SM6766, SM6806	2nd adapter						
SM7046, SM7086, SM7126, SM7166	3rd adapter						
SM7406, SM7446, SM7486, SM7526	4th adapter						
SM6331, SM6371, SM6411, SM6451	1st adapter	Offset/gain setting flag	The offset/gain setting used for each channel is monitored.	○	○	○	R/W
SM6691, SM6731, SM6771, SM6811	2nd adapter						
SM7051, SM7091, SM7131, SM7171	3rd adapter						
SM7411, SM7451, SM7491, SM7531	4th adapter						
SM6332, SM6372, SM6412, SM6452	1st adapter	Offset/gain reading	An offset/gain setting value is read.	○	○	○	R/W
SM6692, SM6732, SM6772, SM6812	2nd adapter						
SM7052, SM7092, SM7132, SM7172	3rd adapter						
SM7412, SM7452, SM7492, SM7532	4th adapter						
SM6333, SM6373, SM6413, SM6453	1st adapter	Offset/gain writing	An offset/gain setting value is written in.	○	○	○	R/W
SM6693, SM6733, SM6773, SM6813	2nd adapter						
SM7053, SM7093, SM7133, SM7173	3rd adapter						
SM7413, SM7453, SM7493, SM7533	4th adapter						
SM6334, SM6374, SM6414, SM6454	1st adapter	Offset/gain initialization	An offset/gain setting value is initialized.	○	○	○	R/W
SM6694, SM6734, SM6774, SM6814	2nd adapter						
SM7054, SM7094, SM7134, SM7174	3rd adapter						
SM7414, SM7454, SM7494, SM7534	4th adapter						
SM6337, SM6377, SM6417, SM6457	1st adapter	A/D conversion alarm clear request	An A/D conversion alarm clear request is performed. OFF: With no A/D conversion alarm clear request ON: With A/D conversion alarm clear request Default value 0: OFF Target:FX5-4A-ADP (CH1, CH2), FX5-4AD-ADP	○	○	○	R/W
SM6697, SM6737, SM6777, SM6817	2nd adapter						
SM7057, SM7097, SM7137, SM7177	3rd adapter						
SM7417, SM7457, SM7497, SM7537	4th adapter						



No. CH1, CH2, CH3, CH4	Connection order	Name	Description	Compatible CPU module			R/W
				FX5S	FX5UJ	FX5U/ FX5UC	
SM6337, SM6377, SM6417, SM6457	1st adapter	D/A conversion alarm clear request	A D/A conversion alarm clear request is performed. OFF: With no D/A conversion alarm clear request ON: With D/A conversion alarm clear request Default value 0: OFF Target:FX5-4A-ADP (CH3, CH4), FX5-4DA-ADP	○	○	○	R/W
SM6697, SM6737, SM6777, SM6817	2nd adapter						
SM7057, SM7097, SM7137, SM7177	3rd adapter						
SM7417, SM7457, SM7497, SM7537	4th adapter						
SM6337, SM6377, SM6417, SM6457	1st adapter	Conversion alarm clear request	A conversion alarm clear request is performed. OFF: With no conversion alarm clear request ON: With conversion alarm clear request Default value 0: OFF Target:FX5-4AD-PT-ADP, FX5-4AD-TC-ADP	○	○	○	R/W
SM6697, SM6737, SM6777, SM6817	2nd adapter						
SM7057, SM7097, SM7137, SM7177	3rd adapter						
SM7417, SM7457, SM7497, SM7537	4th adapter						
SM6338, SM6378, SM6418, SM6458	1st adapter	A/D conversion alarm flag	"A/D conversion alarm flag" turns on when an alarm occurs. OFF: Normal ON: A/D conversion alarm occur Default value 0: OFF To turn OFF the "A/D conversion alarm flag" and clear the "A/D conversion latest alarm code", set the "A/D conversion alarm clear request" from OFF to ON.	○	○	○	R
SM6698, SM6738, SM6778, SM6818	2nd adapter						
SM7058, SM7098, SM7138, SM7178	3rd adapter						
SM7418, SM7458, SM7498, SM7538	4th adapter						
SM6338, SM6378, SM6418, SM6458	1st adapter	D/A conversion alarm flag	"D/A conversion alarm flag" turns on when an alarm occurs. OFF: Normal ON: D/A conversion alarm occur Default value 0: OFF To turn OFF the "D/A conversion alarm flag" and clear the "D/A conversion latest alarm code", set the "D/A conversion alarm clear request" from OFF to ON.	○	○	○	R
SM6698, SM6738, SM6778, SM6818	2nd adapter						
SM7058, SM7098, SM7138, SM7178	3rd adapter						
SM7418, SM7458, SM7498, SM7538	4th adapter						
SM6338, SM6378, SM6418, SM6458	1st adapter	Conversion alarm flag	"Conversion error flag" turns on when an alarm occurs. OFF: Normal ON: Conversion alarm occur Default value 0: OFF To clear "Conversion error flag", turn off and on "error clear request" (SM50) of the CPU module.	○	○	○	R
SM6698, SM6738, SM6778, SM6818	2nd adapter						
SM7058, SM7098, SM7138, SM7178	3rd adapter						
SM7418, SM7458, SM7498, SM7538	4th adapter						



No. CH1, CH2, CH3, CH4	Connection order	Name	Description	Compatible CPU module			R/W
				FX5S	FX5UJ	FX5U/ FX5UC	
SM6339, SM6379, SM6419, SM6459	1st adapter	A/D conversion error flag	<p>"A/D conversion error flag" turns on when an error occurs.</p> <p>OFF: Normal</p> <p>ON: A/D conversion error occur</p> <p>Default value 0: OFF</p> <p>To clear "A/D conversion error flag" and "A/D conversion latest error code", turn off and on "error clear request" (SM50) of the CPU module.</p>	○	○	○	R
SM6699, SM6739, SM6779, SM6819	2nd adapter						
SM7059, SM7099, SM7139, SM7179	3rd adapter						
SM7419, SM7459, SM7499, SM7539	4th adapter						
SM6339, SM6379, SM6419, SM6459	1st adapter	D/A conversion error flag	<p>"D/A conversion error flag" turns on when an error occurs.</p> <p>OFF: Normal</p> <p>ON: D/A conversion error occurs.</p> <p>Default value 0: OFF</p> <p>To clear "D/A conversion error flag" and "D/A conversion latest error code", turn off and on "error clear request" (SM50) of the CPU module.</p>	○	○	○	R
SM6699, SM6739, SM6779, SM6819	2nd adapter						
SM7059, SM7099, SM7139, SM7179	3rd adapter						
SM7419, SM7459, SM7499, SM7539	4th adapter						
SM6339, SM6379, SM6419, SM6459	1st adapter	Conversion error flag	<p>When an error occurs, the conversion error flag turns on.</p> <p>OFF: Normal</p> <p>ON: Conversion error occur</p> <p>Default value 0: OFF</p> <p>To clear "Conversion error flag", turn off and on "error clear request" (SM50) of the CPU module.</p>	○	○	○	R
SM6699, SM6739, SM6779, SM6819	2nd adapter						
SM7059, SM7099, SM7139, SM7179	3rd adapter						
SM7419, SM7459, SM7499, SM7539	4th adapter						

## FX compatible area

The special relays of FX compatible area are shown below.

No.	Name	Description	Compatible CPU module			R/W
			FX5S	FX5UJ	FX5U/ FX5UC	
SM8000	RUN monitor NO contact	OFF: STOP ON: RUN	○	○	○	R
SM8001	RUN monitor NC contact	OFF: RUN ON: STOP	○	○	○	R
SM8002	Initial pulse NO contact	OFF: SM8002 turns off except during 1 scan at the time of RUN ON: SM8002 turns on during 1 scan at the time of RUN	○	○	○	R
SM8003	Initial pulse NC contact	OFF: SM8003 turns on during 1 scan at the time of RUN ON: SM8003 turns off except during 1 scan at the time of RUN	○	○	○	R
SM8004	Error occurrence	OFF: No error ON: Error	○	○	○	R
SM8005	Battery voltage low	OFF: Battery normal ON: Battery voltage low	×	×	○	R
SM8006	Battery error latch	OFF: Battery normal ON: Battery voltage low latch	×	×	○	R

No.	Name	Description	Compatible CPU module			R/W
			FX5S	FX5UJ	FX5U/ FX5UC	
SM8007	Momentary power failure	OFF: No momentary power failure ON: Momentary power failure detected	×	○	○	R
SM8008	Power failure detected	OFF: No momentary power failure ON: During momentary power failure	×	○	○	R
SM8011	10 msec clock pulse	ON and OFF in 10 ms cycles OFF: 5ms ON: 5ms	○	○	○	R
SM8012	100 msec clock pulse	ON and OFF in 100 ms cycles OFF: 50ms ON: 50ms	○	○	○	R
SM8013	1 sec clock pulse	ON and OFF in 1 sec cycles OFF: 500ms ON: 500ms	○	○	○	R
SM8014	1 min clock pulse	ON and OFF in 1 min cycles OFF: 30s ON: 30s	○	○	○	R
SM8015	Clock stop and preset	When SM8015 turns ON, the real time clock is stopped. At the edge from ON to OFF, the time from SD8013 to SD8019 is written to the PLC and the clock is started again.	○	○	○	R
SM8016	Time read display is stopped	When SM8016 turns ON, the time display is stopped.	○	○	○	R
SM8017	±30 seconds correction	At the edge from OFF to ON, the RTC is set to the nearest minute. (When the second data is from 0 to 29, it is set to 0. When the second data is from 30 to 59, it is set to 0 and the minute data is incremented by "1".)	○	○	○	R
SM8019	Real time clock error	When the data stored in special registers is outside the allowable time setting range, this device turns ON.	○	○	○	R
SM8020	Zero	OFF: Zero flag off ON: Zero flag on	○	○	○	R
SM8021	Borrow	OFF: Borrow flag off ON: Borrow flag on	○	○	○	R
SM8022	Carry	OFF: Carry flag off ON: Carry flag on	○	○	○	R
SM8023	Real time clock access error	SM8023 turns ON at the time of RTC access (reading/writing) error occurrence.	○	○	○	R
SM8026	RAMP mode	OFF: Standard mode ON: RAMP mode	○	○	○	R/W
SM8029	Instruction execution complete	OFF: Instruction execution not complete ON: Instruction execution complete	○	○	○	R
SM8031	Non-latch memory all clear	OFF: Do Not Clear ON: Non-latch memory all clear	○	○	○	R/W
SM8032	Latch memory all clear	OFF: Do Not Clear ON: Latch memory all clear	○	○	○	R/W
SM8033	Memory hold stop	OFF: Clear ON: Hold	○	○	○	R/W
SM8034	All output disable	OFF: Normal operation ON: All output disable	○	○	○	R/W
SM8039	Constant scan mode	OFF: Normal operation ON: Constant scan mode	○	○	○	R/W
SM8040	STL: Transfer disable	OFF: Normal operation ON: Transfer disable	○	○	○	R/W
SM8041	STL: Transfer start	Transfer from initial state is enabled in automatic operation mode	○	○	○	R
SM8042	STL: Start pulse	Pulse output is given in response to a start input	○	○	○	R
SM8043	STL: Zero return complete	Set this in the last state of zero return mode	○	○	○	R/W

No.	Name	Description	Compatible CPU module			R/W
			FX5S	FX5UJ	FX5U/ FX5UC	
SM8044	STL: Zero point condition	Set this when machine zero return is detected	○	○	○	R/W
SM8045	STL: All output reset disable	Disables the 'all output reset' function when the operation mode is changed	○	○	○	R/W
SM8046*1	STL: STL state ON	ON when SM8047 is ON and any state (S) is active	○	○	○	R
SM8047*1	STL: Enable STL monitoring (SD8040 to SD8047)	SD8040 to SD8047 are enabled when SM8047 is ON	○	○	○	R/W
SM8048	Annunciator ON	ON when SM8049 is ON and any annunciator (F) is ON.	○	○	○	R
SM8049	Enable annunciator monitoring	SD8049 is enabled when SM8049 is ON.	○	○	○	R/W
SM8050 to SM8055	I0 to I5 interrupt disabled (input interrupt)	OFF: Interrupt enabled ON: Interrupt disabled	○	○	○	R/W
SM8056 to SM8058	I28 to I30 interrupt disabled (interrupt from internal timer)	OFF: Interrupt enabled ON: Interrupt disabled	○	○	○	R/W
SM8059	I16 to I23 interrupt disabled (High-speed comparison match interrupt)	OFF: Interrupt enabled ON: Interrupt disabled	○	○	○	R/W
SM8063	Serial communication error 1 (CH1)	OFF: No error ON: Error	○	○	○	R
SM8067	Operation error	OFF: No error ON: Error	○	○	○	R
SM8068	Operation error latch	OFF: No error ON: Error (latch)	○	○	○	R
SM8072	Parallel link operation	OFF: Stopped ON: In normal running state	○	○	○	R
SM8090	Block comparison signal	Block comparison signal ON when all comparison results are ON.	○	○	○	R
SM8099	High-speed ring counter	OFF: High-speed ring counter stop ON: High-speed ring counter start	○	○	○	R/W
SM8126	Global ON (CH1)	Turns ON when the global command is received.	○	○	○	R
SM8151	Inverter communication (CH1)	ON during inverter communication.	○	○	○	R
SM8152	Inverter communication error (CH1)	OFF: No error ON: Error	○	○	○	R
SM8153	Inverter communication error latch (CH1)	OFF: No error ON: Error (latch)	○	○	○	R
SM8154	IVBWR instruction error (CH1)	OFF: No error ON: Error	○	○	○	R
SM8156	Inverter communication (CH2)	ON during inverter communication.	○	○	○	R
SM8157	Inverter communication error (CH2)	OFF: No error ON: Error	○	○	○	R
SM8158	Inverter communication error latch (CH2)	OFF: No error ON: Error (latch)	○	○	○	R
SM8159	IVBWR instruction error (CH2)	OFF: No error ON: Error	○	○	○	R
SM8161	8 bit operation mode	OFF: 16 bit operation mode ON: 8 bit operation mode	○	○	○	R/W
SM8168	SMOV data mode	BIN→BCD conversion will not be performed, if a SMOV instruction is executed after turning on SM8168.	○	○	○	R/W
SM8170 to SM8177	Input X0 to X7 pulse catch (EI instruction required)	Turns ON when X0 to X7 turn from OFF to ON.	○	○	○	R/W
SM8183	Data communication error (Master station)	OFF: No error ON: Error	○	○	○	R
SM8184 to SM8190	Data communication error (Slave station No.1 to No.7)	OFF: No error ON: Error	○	○	○	R

No.	Name	Description	Compatible CPU module			R/W
			FX5S	FX5UJ	FX5U/ FX5UC	
SM8191	Data communication in execution	OFF: Data communication in nonexecution ON: Data communication in execution	○	○	○	R
SM8200 to SM8234	LC0 to LC34 counting direction specification	OFF: Up-counting specification ON: Down-counting specification	○	○	○	R/W
SM8246 to SM8255	LC46 to LC55 counting direction monitoring	OFF: Up-counting specification ON: Down-counting specification	○	○	○	R
SM8304	Zero (MUL, DIV instructions only)	OFF: Zero flag off ON: Zero flag on	○	○	○	R
SM8306	Carry (MUL, DIV instructions only)	OFF: Carry flag off ON: Carry flag on	○	○	○	R
SM8312	RTC clock data loss error	ON when the RTC clock data loss error is occurred.	○	○	○	R
SM8328	Instruction non-execution	Turns ON when the RBFM instruction or WBFM instruction in another step is executed for the same module number.	×	×	○	R/W
SM8329	Instruction execution error	OFF: Instruction execution normal ON: Instruction execution error complete	○	○	○	R
SM8330 to SM8334	Timing clock outputs 1 to 5	DUTY instruction: Timing clock outputs 1 to 5	○	○	○	R
SM8340, SM8350, SM8360	Axes 1 to 3 pulse output monitor	OFF: Stopped ON: Pulse output	○	○	○	R
SM8348, SM8358, SM8368	Axes 1 to 3 positioning instruction executing	OFF: Positioning instruction not executing ON: Positioning instruction executing	○	○	○	R
SM8370	Axis 4 pulse output monitor	OFF: Stopped ON: Pulse output	○	×	○	R
SM8378	Axis 4 positioning instruction executing	OFF: Positioning instruction not executing ON: Positioning instruction executing	○	×	○	R
SM8393	Delay time setting contact	Used for identifying the input interrupt delay function pattern programs.	○	○	○	R/W
SM8401, SM8421	RS2 send wait flag (CH1, CH2)/MODBUS request in process (CH1, CH2)	Turns ON during send wait or MODBUS communication.	○	○	○	R
SM8402, SM8422	MODBUS communication error (CH1, CH2)	OFF: No error ON: Error	○	○	○	R
SM8403, SM8423	MODBUS communication error (latched) (CH1, CH2)	OFF: No error ON: Error (latch)	○	○	○	R
SM8404, SM8424	RS2 carrier detection flag (CH1, CH2)/MODBUS communication mode (CH1, CH2)	Turns ON during carrier detection or listen only mode.	○	○	○	R
SM8405, SM8425	RS2 Data set ready (DSR) flag (CH1, CH2)	OFF: DSR not detected ON: DSR detected	○	○	○	R
SM8408, SM8428	MODBUS retry (CH1, CH2)	OFF: No retry ON: Retry	○	○	○	R
SM8409, SM8429	RS2 time-out check flag (CH1, CH2)/MODBUS timeout (CH1, CH2)	Turns ON when time-out occurs.	○	○	○	R
SM8419, SM8439	Absence/presence of MC protocol (CH1, CH2)	Turns ON when MC protocol is set for serial communication.	○	○	○	R
SM8426	Global ON (CH2)	Turns ON when the global command is received.	○	○	○	R
SM8438	Serial communication error 2 (CH2)	OFF: No error ON: Error	○	○	○	R
SM8492	IP address storage area write request	If OFF to ON, the IP address setting stored in SD8492 to SD8497 will be written in the IP address storage area.	○	○	○	R/W

No.	Name	Description	Compatible CPU module			R/W
			FX5S	FX5UJ	FX5U/ FX5UC	
SM8493	IP address storage area write completed	<ul style="list-style-type: none"> <li>It turns on, if the write to the IP address storage area is completed. Moreover, it turns on also at the time of the write-in failure.</li> <li>Turns OFF when IP address storage area write request (SM8492) turns from ON to OFF.</li> </ul>	○	○	○	R
SM8494	IP address storage area write error	<ul style="list-style-type: none"> <li>Turns ON when writing to IP address storage area is failed.</li> <li>Turns ON if there is a problem in contents of IP address storage area, when PLC power supply is turned from OFF to ON.</li> <li>Turns OFF when IP address storage area write request (SM8492) turns from ON to OFF.</li> </ul>	○	○	○	R
SM8495	IP address storage area clear request	Contents of IP address storage area are cleared when this device turns from OFF to ON.	○	○	○	R/W
SM8496	IP address storage area clear completed	<ul style="list-style-type: none"> <li>It turns on, if the clear to the IP address storage area is completed. Moreover, it turns on also at the time of the clear-in failure.</li> <li>Turns OFF when IP address storage area clear request (SM8495) turns from ON to OFF.</li> </ul>	○	○	○	R
SM8497	IP address storage area clear error	<ul style="list-style-type: none"> <li>Turns ON when clear to IP address storage area is failed.</li> <li>Turns OFF when IP address storage area clear request (SM8495) turns from ON to OFF.</li> </ul>	○	○	○	R
SM8498	IP address change function enable flag	Turns ON when IP address is changed by IP address change function.	○	○	○	R

\*1 Enabled only when the STL instruction is used.

## LC□ count direction monitor

This is the device to monitor the directions of the counters from LC46 to LC55 when the FX3 compatible high-speed counter is used.

### ■Operation description

The content of the operation when ON and when OFF is as follows.

Operation when ON	Operation when OFF
High-speed counter counting in direction whereby current value is reduced (Down-counting)	High-speed counter counting in direction whereby current value is increased (Up-counting)

### ■Update timing

The timing of device update is as follows.

ON	OFF
<ul style="list-style-type: none"> <li>Down-counting (This is updated with the END processing. When the FX3 compatible high-speed counter function is valid, the updating is made also when UDCNTF instruction is executed ON.)</li> </ul>	<ul style="list-style-type: none"> <li>Up-counting (This is updated with the END processing. When the FX3 compatible high-speed counter function is valid, the updating is made also when UDCNTF instruction is executed ON.)</li> <li>Power ON, reset</li> <li>STOP/PAUSE→RUN</li> </ul>

# Serial communication function

The special relays for the serial communication function are shown below.

No.	Name	Description	Compatible CPU module			R/W
			FX5S	FX5UJ	FX5U/ FX5UC*1	
SM8500	Serial communication error (CH1)	OFF: No error ON: Error	×	×	○	R
SM8503	Absence/presence of MC protocol (CH1)	Turns ON when MC protocol is set for serial communication.	×	×	○	R
SM8510, SM8520, SM8530	Serial communication error (CH2 to CH4)	OFF: No error ON: Error	○	○	○	R
SM8513, SM8523, SM8533	Absence/presence of MC protocol (CH2 to CH4)	Turns ON when MC protocol is set for serial communication.	×	×	○	R
SM8560	Data transfer delayed (CH1)	This device remains ON while the PLC is waiting to send.	×	×	○	R
SM8561	Data transfer flag (CH1)	When this device is set to ON, the PLC starts to send.	×	×	○	R/W
SM8562	Receive completion flag (CH1)	This device turns ON when receiving is completed.	×	×	○	R
SM8563	Carrier detection flag (CH1)	This device turns ON in synchronization with the CD (DCD) signal.	×	×	○	R
SM8564	Data set ready flag (CH1)	This device turns ON in synchronization with the DR (DSR) signal.	×	×	○	R
SM8565	Time-out check flag (CH1)	This device turns ON when data receiving is suspended and the next set of receive data is not given within the time set by the time-out time setting device.	×	×	○	R
SM8570, SM8580, SM8590	Data transfer delayed (CH2 to CH4)	This device remains ON while the PLC is waiting to send.	○	○	○	R
SM8571, SM8581, SM8591	Data transfer flag (CH2 to CH4)	When this device is set to ON, the PLC starts to send.	○	○	○	R/W
SM8572, SM8582, SM8592	Receive completion flag (CH2 to CH4)	This device turns ON when receiving is completed.	○	○	○	R
SM8573, SM8583, SM8593	Carrier detection flag (CH2 to CH4)	This device turns ON in synchronization with the CD (DCD) signal.	○	○	○	R
SM8574, SM8584, SM8594	Data set ready flag (CH2 to CH4)	This device turns ON in synchronization with the DR (DSR) signal.	○	○	○	R
SM8575, SM8585, SM8595	Time-out check flag (CH2 to CH4)	This device turns ON when data receiving is suspended and the next set of receive data is not given within the time set by the time-out time setting device.	○	○	○	R
SM8680	Global ON (CH1)	Turns ON when the global command is received.	×	×	○	R
SM8690, SM8700, SM8710	Global ON (CH2 to CH4)	Turns ON when the global command is received.	○	○	○	R
SM8740	Station No. setting SD latch enabled (CH1)	OFF: Latch disabled ON: Latch enabled	×	×	○	R
SM8750, SM8760, SM8770	Station No. setting SD latch enabled (CH2 to CH4)	OFF: Latch disabled ON: Latch enabled	○	○	○	R
SM8800	MODBUS RTU communication (CH1)	OFF: Communication stop ON: Communication	×	×	○	R
SM8801	Retry (CH1)	OFF: No retry ON: Retry	×	×	○	R
SM8802	Timeout (CH1)	OFF: No timeout ON: Timeout	×	×	○	R
SM8810, SM8820, SM8830	MODBUS RTU communication (CH2 to CH4)	OFF: Communication stop ON: Communication	○	○	○	R
SM8811, SM8821, SM8831	Retry (CH2 to CH4)	OFF: No retry ON: Retry	○	○	○	R

No.	Name	Description	Compatible CPU module			R/W
			FX5S	FX5UJ	FX5U/ FX5UC*1	
SM8812, SM8822, SM8832	Timeout (CH2 to CH4)	OFF: No timeout ON: Timeout	○	○	○	R
SM8861	Host station No. setting SD latch enabled (CH1)	OFF: Latch disabled ON: Latch enabled	×	×	○	*2
SM8871, SM8881, SM8891	Host station No. setting SD latch enabled (CH2 to CH4)	OFF: Latch disabled ON: Latch enabled	○	○	○	*2
SM8920	Inverter communication (CH1)	OFF: Communication stop ON: Communication	×	×	○	R
SM8921	IVBWR instruction error (CH1)	OFF: No error ON: Error	×	×	○	R
SM8930, SM8940, SM8950	Inverter communication (CH2 to CH4)	OFF: Communication stop ON: Communication	○	○	○	R
SM8931, SM8941, SM8951	IVBWR instruction error (CH2 to CH4)	OFF: No error ON: Error	○	○	○	R
SM9040	Data communication error (Master station)	OFF: No error ON: Error	○	○	○	R
SM9041 to SM9047	Data communication error (Slave station No.1 to No.7)	OFF: No error ON: Error	○	○	○	R
SM9056	Data communication in execution	OFF: Data communication in nonexecution ON: Data communication in execution	○	○	○	R
SM9080	Station No. setting SD latch enabled	OFF: Latch disabled ON: Latch enabled	○	○	○	R
SM9081	Slave station total number setting SD latch enabled	OFF: Latch disabled ON: Latch enabled	○	○	○	R
SM9090	Parallel link operation	OFF: Stopped ON: In normal running state	○	○	○	R

\*1 CH2 devices for serial communication are not supported by FX5UC CPU module.

\*2 Varies according to the GX Works3 latch setting.

R if the latch setting is disabled because the module operates according to the value set for the GX Works3 parameter.

R/W if the latch setting is enabled.

· The special relay is ON: The module operates according to the value set for the special register.

· The special relay is OFF: The module operates according to the value set for the GX Works3 parameter.

## Extended file register function

The special relays for extended file register function are shown below.

No.	Name	Description	Compatible CPU module			R/W
			FX5S	FX5UJ	FX5U/ FX5UC	
SM9366	Extended file register (ER) access flag	Turns ON while the extended file register (ER) is being accessed.	○	○	○	R



# Appendix 2 Special Register List

The following table shows items in the list for special registers (SD).

Item	Description
No.	Special register number
Name	Special register name
Description	Data stored in the special register
Compatible CPU module	Shows CPU modules that support the special register. The support status is represented by the following symbols. <ul style="list-style-type: none"> <li>○: Supported</li> <li>×: Not supported</li> </ul>
R/W	The following symbols show whether the special register can be read/written. <ul style="list-style-type: none"> <li>R: Read-only</li> <li>W: Write-only</li> <li>R/W: Read/Write</li> </ul>

## Diagnostic information

The special registers for diagnostic information are shown below.

No.	Name	Description	Compatible CPU module			R/W										
			FX5S	FX5UJ	FX5U/ FX5UC											
SD0	Latest self diagnostics error code	This register stores the latest self-diagnosis error code.	○	○	○	R										
SD1	Clock time for self-diagnostics error occurrence (Year)	This register stores the latest self-diagnosis error time (Year).	○	○	○	R										
SD2	Clock time for self-diagnostics error occurrence (Month)	This register stores the latest self-diagnosis error time (Month).	○	○	○	R										
SD3	Clock time for self-diagnostics error occurrence (Day)	This register stores the latest self-diagnosis error time (Day).	○	○	○	R										
SD4	Clock time for self-diagnostics error occurrence (Hour)	This register stores the latest self-diagnosis error time (Hour).	○	○	○	R										
SD5	Clock time for self-diagnostics error occurrence (Minute)	This register stores the latest self-diagnosis error time (Minute).	○	○	○	R										
SD6	Clock time for self-diagnostics error occurrence (Second)	This register stores the latest self-diagnosis error time (Second).	○	○	○	R										
SD7	Clock time for self-diagnostics error occurrence (Day Week)	This register stores the latest self-diagnosis error time (Day Week).	○	○	○	R										
SD10 to SD25	Self-diagnostics error code 1 to 16	These registers store the self-diagnosis error code.	○	○	○	R										
SD53	The number of AC/DC DOWN detections	This register stores the number of times of momentary power failure.	×	○	○	R										
SD61	I/O Module Verify Error Module No.	This register stores the I/O module verify error module No.	×	○	○	R										
SD62	Annunciator (F) Detection No.	This register stores the earliest detected annunciator (F) No.	○	○	○	R										
SD63	Annunciator (F) Detection Number	This register stores the number of annunciator (F) detections.	○	○	○	R										
SD64 to SD79	Annunciator (F) Detection No. table	This register stores the annunciator (F) detection No.	○	○	○	R										
SD80	Detailed information 1 information category	<ul style="list-style-type: none"> <li>Detailed information 1 information category code is stored.</li> </ul> <table border="1" style="margin-left: 20px;"> <tr> <td style="text-align: center;">b15</td> <td style="text-align: center;">to</td> <td style="text-align: center;">b8 b7</td> <td style="text-align: center;">to</td> <td style="text-align: center;">b0</td> </tr> <tr> <td style="text-align: center;">Not used (fixed to 0)</td> <td></td> <td style="text-align: center;">Information category code</td> <td></td> <td></td> </tr> </table> <ul style="list-style-type: none"> <li>The following codes are stored into the information category code.</li> <li>0: N/A</li> <li>1: Program position information</li> <li>2: Drive number and file name</li> <li>4: Parameter information</li> <li>5: System configuration information</li> <li>6: Number of times information</li> <li>7: Time information</li> </ul>	b15	to	b8 b7	to	b0	Not used (fixed to 0)		Information category code			○	○	○	R
b15	to	b8 b7	to	b0												
Not used (fixed to 0)		Information category code														

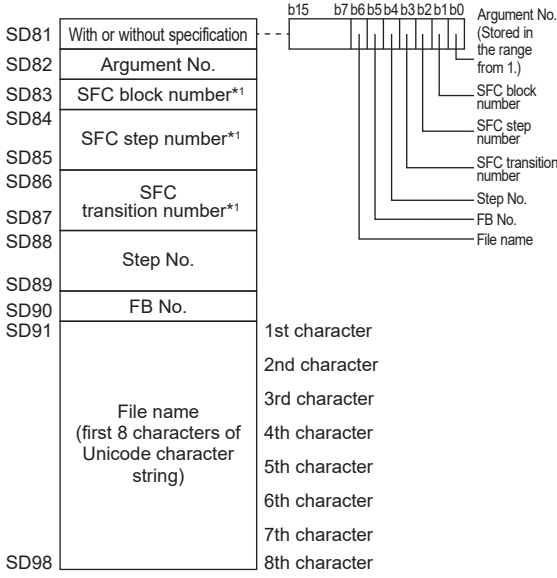
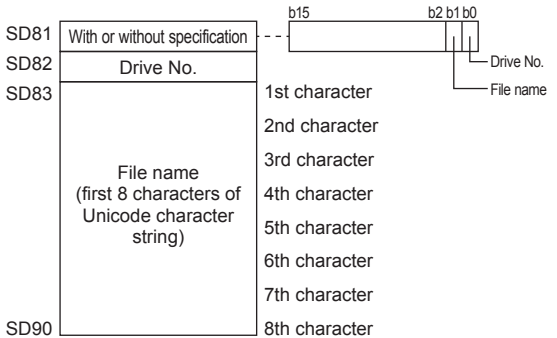
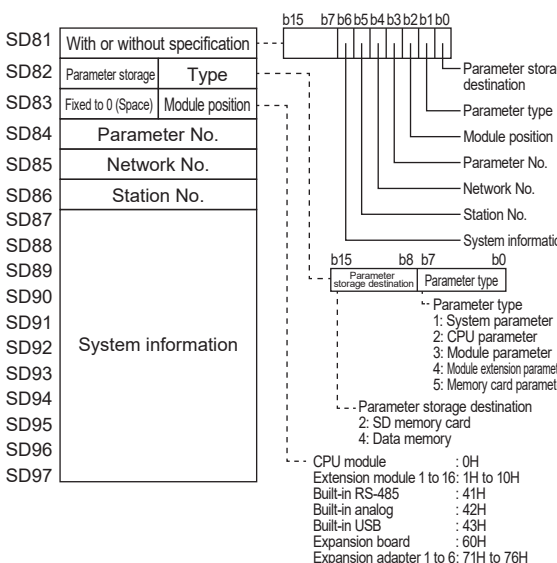

No.	Name	Description	Compatible CPU module			R/W
			FX5S	FX5UJ	FX5U/ FX5UC	
SD81 to SD111	Detailed information 1	<ul style="list-style-type: none"> <li>Detailed information 1 corresponding to the error code (SD0) is stored.</li> <li>There are six types of information to be stored as shown in the following figures.</li> <li>The type of detailed information 1 can be obtained using SD80 (the value of the "Detailed information 1 information category code" stored in SD80 corresponds to the following figures (1), (2), (4) to (7)).</li> </ul> <p>(1) Program location information</p>  <p>(2) Drive number and file name</p>  <p>(4) Parameter information</p>  <p>     CPU module : 0H      Extension module 1 to 16: 1H to 10H      Built-in RS-485 : 41H      Built-in analog : 42H      Built-in USB : 43H      Expansion board : 60H      Expansion adapter 1 to 6: 71H to 76H   </p>	○	○	○	R

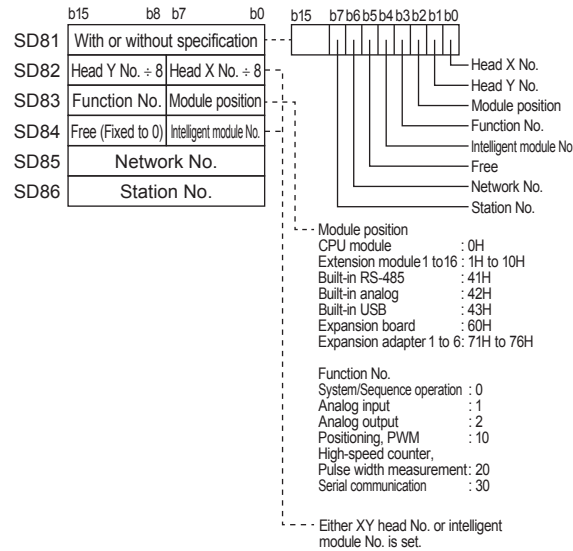
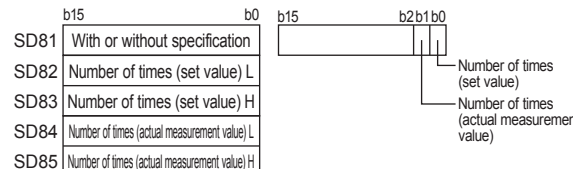
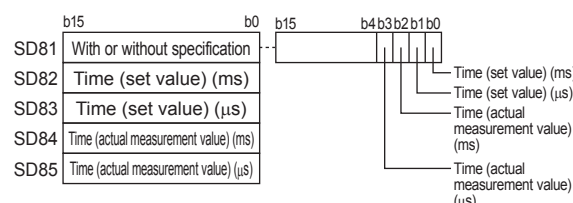
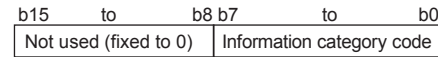
No.	Name	Description	Compatible CPU module			R/W
			FX5S	FX5UJ	FX5U/ FX5UC	
SD81 to SD111	Detailed information 1	<p>(5) System configuration information</p>  <p>(6) Number of times information</p>  <p>(7) Time information</p> 	○	○	○	R
SD112	Detailed information 2 information category	<p>• Detailed information 2 information category code is stored.</p>  <p>• The following codes are stored into the information category code.</p> <p>0: N/A  2: Drive number and file name  3: Annunciator number  4: Parameter information  5: System configuration information</p>	○	○	○	R



No.	Name	Description	Compatible CPU module			R/W
			FX5S	FX5UJ	FX5U/ FX5UC	
SD113 to SD143	Detailed information 2	<ul style="list-style-type: none"> <li>Detailed information 2 corresponding to the error code (SD0) is stored.</li> <li>There are four types of information to be stored as shown in the following figures.</li> <li>The type of detailed information 2 can be obtained using SD112 (the value of the "Detailed information 2 information category code" stored in SD112 corresponds to the following figures (2) to (5)).</li> </ul> <p>(2) Drive number and file name</p> <p>(3) Annunciator number</p> <p>(4) Parameter information</p> <p>(5) System configuration information</p>	○	○	○	R

\*1 Fixed to 0 if the SFC program is not used.

# System information

The special registers for system information are shown below.

No.	Name	Description	Compatible CPU module			R/W
			FX5S	FX5UJ	FX5U/ FX5UC	
SD200	Switch Status	This register stores the CPU switch status. 0: RUN 1: STOP	○	○	○	R
SD201	LED Status	This register stores the LED status. b2: ERR lit b3: ERR flashing b4: P.RUN b5: PAUSE b9: BAT flashing b12: SD memory card available or not removable b13: Preparing SD memory card	○	○	○	R
SD203	CPU Status	This register stores the CPU Status. 0: RUN 2: STOP 3: PAUSE	○	○	○	R
SD210	Clock Data (Year)	This register stores the clock data (Year).	○	○	○	R/W
SD211	Clock Data (Month)	This register stores the clock data (Month).	○	○	○	R/W
SD212	Clock Data (Day)	This register stores the clock data (Day).	○	○	○	R/W
SD213	Clock Data (Hour)	This register stores the clock data (Hour).	○	○	○	R/W
SD214	Clock Data (Minute)	This register stores the clock data (Minute).	○	○	○	R/W
SD215	Clock Data (Second)	This register stores the clock data (Second).	○	○	○	R/W
SD216	Clock Data (Day Week)	This register stores the clock data (Day of the Week).	○	○	○	R/W
SD218	Time zone setting value	The time zone setting value specified in the parameter is stored in increments of minutes.	○	○	○	R
SD250	Loaded Max I/O	This register stores high-order 2 digits of the final I/O number of connected modules +1 in 8-bit binary.	○	○	○	R
SD260	X Device Size [Lower]	This register stores the number of X device points used as 32-bit value.	○	○	○	R
SD261	X Device Size [Upper]					
SD262	Y Device Size [Lower]	This register stores the number of Y device points used as 32-bit value.	○	○	○	R
SD263	Y Device Size [Upper]					
SD264	M Device Size [Lower]	This register stores the number of M device points used as 32-bit value.	○	○	○	R
SD265	M Device Size [Upper]					
SD266	B Device Size [Lower]	This register stores the number of B device points used as 32-bit value.	○	○	○	R
SD267	B Device Size [Upper]					
SD268	SB Device Size [Lower]	This register stores the number of SB device points used as 32-bit value.	○	○	○	R
SD269	SB Device Size [Upper]					
SD270	F Device Size [Lower]	This register stores the number of F device points used as 32-bit value.	○	○	○	R
SD271	F Device Size [Upper]					
SD274	L Device Size [Lower]	This register stores the number of L device points used as 32-bit value.	○	○	○	R
SD275	L Device Size [Upper]					
SD280	D Device Size [Lower]	This register stores the number of D device points used as 32-bit value.	○	○	○	R
SD281	D Device Size [Upper]					
SD282	W Device Size [Lower]	This register stores the number of W device points used as 32-bit value.	○	○	○	R
SD283	W Device Size [Upper]					
SD284	SW Device Size [Lower]	This register stores the number of SW device points used as 32-bit value.	○	○	○	R
SD285	SW Device Size [Upper]					
SD288	T Device Size [Lower]	This register stores the number of T device points used as 32-bit value.	○	○	○	R
SD289	T Device Size [Upper]					

No.	Name	Description	Compatible CPU module			R/W
			FX5S	FX5UJ	FX5U/ FX5UC	
SD290	ST Device Size [Lower]	This register stores the number of ST device points used as 32-bit value.	○	○	○	R
SD291	ST Device Size [Upper]					
SD292	C Device Size [Lower]	This register stores the number of C device points used as 32-bit value.	○	○	○	R
SD293	C Device Size [Upper]					
SD298	LC Device Size [Lower]	This register stores the number of LC device points used as 32-bit value.	○	○	○	R
SD299	LC Device Size [Upper]					
SD300	Z Device Size	This register stores the number of Z device points used.	○	○	○	R
SD302	LZ Device Size	This register stores the number of LZ device points used.	○	○	○	R
SD304	R Device Size [Lower]	This register stores the number of R device points used as 32-bit value.	○	○	○	R
SD305	R Device Size [Upper]					

## SFC information

The special register for SFC information is shown below.

No.	Name	Description	Compatible CPU module			R/W
			FX5S	FX5UJ	FX5U/ FX5UC	
SD329	Online change (SFC block) target block No.	<ul style="list-style-type: none"> <li>The target SFC block number is stored during online change (SFC block) (SM329=ON).</li> <li>FFFFH is stored if there is no online change (SFC block).</li> </ul>	○	○	○	R

## System clock

The special registers for system clock are shown below.

No.	Name	Description	Compatible CPU module			R/W
			FX5S	FX5UJ	FX5U/ FX5UC	
SD412	One second counter	<ul style="list-style-type: none"> <li>This register is incremented by 1 for each second after the CPU module is set to RUN.</li> <li>A counting cycle from 0 to 32767 to -32768 to 0 is repeated.</li> </ul>	○	○	○	R
SD414	2n second clock setting	<ul style="list-style-type: none"> <li>Stores value n of 2n second clock (Default: 30).</li> <li>Setting can be made between 1 and 32767.</li> </ul>	○	○	○	R/W
SD415	2nms second clock setting	<ul style="list-style-type: none"> <li>Stores value n of 2n ms clock (Default: 30).</li> <li>Setting can be made between 1 and 32767.</li> </ul>	○	○	○	R/W
SD420	Scan counter	<ul style="list-style-type: none"> <li>This register is incremented by 1 each scan after the CPU module is set to RUN. (Not incremented for each scan of an initial execution type program.)</li> <li>A counting cycle from 0 to 32767 to -32768 to 0 is repeated.</li> </ul>	○	○	○	R

# Scan information

The special registers for scan information are shown below.

No.	Name	Description	Compatible CPU module			R/W
			FX5S	FX5UJ	FX5U/ FX5UC	
SD518	Initial scan time (ms)	<ul style="list-style-type: none"> <li>The initial scan time is stored into SD518 and SD519 (it is measured in increments of <math>\mu</math>s).</li> <li>SD518: stores a value in the ms place (storage range: 0 to 65535)</li> <li>SD519: stores a value in the <math>\mu</math>s place (storage range: 0 to 999)</li> <li>This register is cleared to 0 when the mode transfers from STOP to RUN mode.</li> </ul>	○	○	○	R
SD519	Initial scan time ( $\mu$ s)		○	○	○	R
SD520	Current scan time (ms)	<ul style="list-style-type: none"> <li>The current scan time is stored into SD520 and SD521 (it is measured in increments of <math>\mu</math>s).</li> <li>SD520: stores a value in the ms place (storage range: 0 to 65535)</li> <li>SD521: stores a value in the <math>\mu</math>s place (storage range: 0 to 999)</li> <li>Example: If the current scan time is 23.6ms, the following values are stored: SD520 = 23 SD521 = 600</li> <li>This register is cleared to 0 when the mode transfers from STOP to RUN mode.</li> </ul>	○	○	○	R
SD521	Current scan time ( $\mu$ s)		○	○	○	R
SD522	Minimum scan time (ms)	<ul style="list-style-type: none"> <li>The minimum value of the scan time other than that of the initial execution program is stored into SD522 and SD523 (it is measured in increments of <math>\mu</math>s).</li> <li>SD522: stores a value in the ms place (storage range: 0 to 65535)</li> <li>SD523: stores a value in the <math>\mu</math>s place (storage range: 0 to 999)</li> <li>This register is cleared to 0 when the mode transfers from STOP to RUN mode.</li> </ul>	○	○	○	R
SD523	Minimum scan time ( $\mu$ s)		○	○	○	R
SD524	Maximum scan time (ms)	<ul style="list-style-type: none"> <li>The maximum value of the scan time other than that of the initial execution program is stored into SD524 and SD525 (it is measured in increments of <math>\mu</math>s).</li> <li>SD524: stores a value in the ms place (storage range: 0 to 65535)</li> <li>SD525: stores a value in the <math>\mu</math>s place (storage range: 0 to 999)</li> <li>This register is cleared to 0 when the mode transfers from STOP to RUN mode.</li> </ul>	○	○	○	R
SD525	Maximum scan time ( $\mu$ s)		○	○	○	R
SD526	END processing time (ms)	<ul style="list-style-type: none"> <li>The time period from completion of a scan program until start of the next scan is stored into SD526 to SD527 (it is measured in increments of <math>\mu</math>s).</li> <li>SD526: stores a value in the ms place (storage range: 0 to 65535)</li> <li>SD527: stores a value in the <math>\mu</math>s place (storage range: 0 to 999)</li> <li>This register is cleared to 0 when the mode transfers from STOP to RUN mode.</li> </ul>	○	○	○	R
SD527	END processing time ( $\mu$ s)		○	○	○	R
SD528	Constant scan waiting time (ms)	<ul style="list-style-type: none"> <li>The waiting time specified in the constant scan setting process is stored into SD528 and SD529 (it is measured in increments of <math>\mu</math>s).</li> <li>SD528: stores a value in the ms place (storage range: 0 to 65535)</li> <li>SD529: stores a value in the <math>\mu</math>s place (storage range: 0 to 999)</li> <li>This register is cleared to 0 when the mode transfers from STOP to RUN mode.</li> </ul>	○	○	○	R
SD529	Constant scan waiting time ( $\mu$ s)		○	○	○	R



No.	Name	Description	Compatible CPU module			R/W
			FX5S	FX5UJ	FX5U/ FX5UC	
SD530	Scan program execution time (ms)	<ul style="list-style-type: none"> <li>The execution time of the scan program for one scan is stored into SD530 and SD531 (it is measured in increments of <math>\mu</math>s).</li> <li>SD530: stores a value in the ms place (storage range: 0 to 65535)</li> <li>SD531: stores a value in the <math>\mu</math>s place (storage range: 0 to 999)</li> <li>This register is cleared to 0 when the mode transfers from STOP to RUN mode.</li> </ul>	○	○	○	R
SD531	Scan program execution time ( $\mu$ s)		○	○	○	R

## Drive information

The special registers for drive information are shown below.

No.	Name	Description	Compatible CPU module			R/W
			FX5S	FX5UJ	FX5U/ FX5UC	
SD600	SD memory card mounting status	This register stores the enable/disable classification of the inserted SD card.	○	○	○	R
SD604	SD memory card usage status	The usage status of the SD memory card is stored using the following bit pattern. (On indicates being used.) b0: Event history b1 to b15: Not used	○	○	○	R
SD606	SD memory card capacity: Least significant byte	This register stores the drive 2 storage capacity (unit: 1 K byte). (Free space value after formatting is stored.)	○	○	○	R
SD607	SD memory card capacity: Lower byte	This register stores the drive 2 storage capacity (unit: 1 K byte). (Free space value after formatting is stored.)	○	○	○	R
SD608	SD memory card capacity: Upper byte	This register stores the drive 2 storage capacity (unit: 1 K byte). (Free space value after formatting is stored.)	○	○	○	R
SD609	SD memory card capacity: Most significant byte	This register stores the drive 2 storage capacity (unit: 1 K byte). (Free space value after formatting is stored.)	○	○	○	R
SD610	SD memory card free space capacity: Least significant byte	This register stores the free space value in drive 2 (unit: 1 K byte).	○	○	○	R
SD611	SD memory card free space capacity: Lower byte	This register stores the free space value in drive 2 (unit: 1 K byte).	○	○	○	R
SD612	SD memory card free space capacity: Upper byte	This register stores the free space value in drive 2 (unit: 1 K byte).	○	○	○	R
SD613	SD memory card free space capacity: Most significant byte	This register stores the free space value in drive 2 (unit: 1 K byte).	○	○	○	R
SD634	Index for the number of data memory write operations	Stores an index for the number of write operations to data memory currently. However, the index does not equal the actual number of write operations.	○	○	○	R
SD635						



## Instruction related

The special registers related to instruction execution are shown below.

No.	Name	Description	Compatible CPU module			R/W
			FX5S	FX5UJ	FX5U/ FX5UC	
SD757	Current interrupt priority	This register stores the interrupt priority of the interrupt program being executed. 1 to 3: Priority for the interrupt pointer of the interrupt program currently being executed 0: No interrupt operation (default)	○	○	○	R
SD758	Interrupt disabling for each priority setting value	This register stores the disable interrupt priority according to the disable interrupt instruction (DI), disable interrupt after the setting priority instruction (DI), and enable interrupt instruction (EI). 1: Disable interrupt priority 1 or less. (Disable interrupts of all priorities) (default value) 2: Disable interrupt priority 2 or 3. 3: Disable interrupt priority 3. 0: No priority. (Enable interrupt of all priority)	○	○	○	R
SD771	Specification of the number of write instruction executions to data memory	This register stores the setting value of limitation in the number of write operations in one day by instruction executions.	○	○	○	R/W

## Latch area

The special registers for latch area are shown below.

No.	Name	Description	Compatible CPU module			R/W																				
			FX5S	FX5UJ	FX5U/ FX5UC																					
SD953	Backup error cause	The cause of the error that occurred during the data backup is stored. • 0: No error • Other than 0: Error code "0" is set at the start of the data backup.	○	○	○	R																				
SD954	Restoration target data setting	Set the target data to be restored with the data restoration function. 0: All the target data 1: Device/label data only 2: All target data excluding device/label data	○	○	○	R/W																				
SD955	Restoration function setting	Set the data restoration function using the following bit pattern. (OFF: Disabled, ON: Enabled)  <div style="display: flex; justify-content: space-between; align-items: center;"> <span>b15 b14 b13</span> <span>b1 b0</span> </div> <table border="1" style="margin: 5px auto; border-collapse: collapse;"> <tr> <td style="width: 20px; height: 15px;"></td> <td style="width: 20px; height: 15px;"></td> <td style="width: 20px; height: 15px;"></td> <td style="width: 20px; height: 15px;"></td> <td style="width: 20px; height: 15px;"></td> <td style="width: 20px; height: 15px;"></td> <td style="width: 20px; height: 15px;"></td> <td style="width: 20px; height: 15px;"></td> <td style="width: 20px; height: 15px;"></td> <td style="width: 20px; height: 15px;"></td> </tr> <tr> <td colspan="10" style="text-align: center;">0</td> </tr> </table> b0: Auto restoration request b1: Initialization setting at the automatic restoration b13: Restoration target folder b14: Restoration for the special relay and special register b15: Setting of operation after restoration											0										○	○	○	R/W
0																										
SD956 SD957	Restoration target date folder setting	Store the target folder (date folder) of the data restoration using BCD code.  <div style="display: flex; justify-content: space-around; align-items: center;"> <div style="border: 1px dashed black; padding: 2px;">SD957</div> <div style="border: 1px dashed black; padding: 2px;">SD956</div> </div> <table border="1" style="margin: 5px auto; border-collapse: collapse;"> <tr> <td style="width: 20px; height: 15px;">b31</td> <td style="width: 20px; height: 15px;">b24</td> <td style="width: 20px; height: 15px;">b23</td> <td style="width: 20px; height: 15px;">b16</td> <td style="width: 20px; height: 15px;">b15</td> <td style="width: 20px; height: 15px;">b8</td> <td style="width: 20px; height: 15px;">b7</td> <td style="width: 20px; height: 15px;">b0</td> </tr> <tr> <td style="text-align: center;">(4)</td> <td style="text-align: center;">(3)</td> <td style="text-align: center;">(2)</td> <td style="text-align: center;">(1)</td> <td colspan="4"></td> </tr> </table> (1) Day (1 to 31) (2) Month (1 to 12) (3) Year (last two digits) (0 to 99) (4) Year (first two digits) (0 to 99) [Example] To specify the date folder of June 15 2015, store "20150615H".	b31	b24	b23	b16	b15	b8	b7	b0	(4)	(3)	(2)	(1)					○	○	○	R/W				
b31	b24	b23	b16	b15	b8	b7	b0																			
(4)	(3)	(2)	(1)																							
SD958	Restoration target number folder setting	Specify the target folder of the data restoration. 1 to 32767: Serial number of the backup folder (*****) in a date folder (00001 to 32767)	○	○	○	R/W																				

A

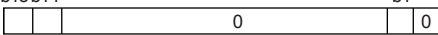
No.	Name	Description	Compatible CPU module			R/W
			FX5S	FX5UJ	FX5U/ FX5UC	
SD959	Restoration error cause	The cause of the error that occurred during the data restoration is stored. • 0: No error • Other than 0: Error code "0" is set at the start of the data backup.	○	○	○	R
SD9350	Operation mode setting	Set the operation mode of backup. 0: Normal Mode 1: CPU module auto exchange mode (Deleting existing data) 2: CPU module auto exchange mode (Holding existing data)	○	○	○	R/W
SD9351	CPU module automatic replacement function Restore target data setting	Set the target data restored with the CPU module auto exchange function. 0: Device/label data only 1: All the target data 2: All target data excluding device/label data	○	○	○	R/W
SD9352	CPU module auto exchange function setting	Set the target data restored with the CPU module auto exchange function.  <div style="text-align: center;">           b15b14 <span style="float: right;">b1</span>   </div> b1: Initialize during CPU module auto exchange function b14: Restoration for the special relay and special register (CPU module auto exchange function) b15: Setting of operation after CPU module auto exchange function	○	○	○	R/W

## Data logging function

The special registers for data logging function are shown below.

No.	Name	Description	Compatible CPU module			R/W
			FX5S	FX5UJ	FX5U/ FX5UC	
SD1203	Data logging file transfer stop information	Use a bit pattern to specify the setting number to stop logging file transfer. b0: Setting No.1 b1: Setting No.2 b2: Setting No.3 b3: Setting No.4	○	○	○	R/W
SD1210	Data logging setting No.1 Latest storage file number [Low-order]	This register stores the latest storage file number.	○	○	○	R
SD1211	Data logging setting No.1 Latest storage file number [High-order]					
SD1212	Data logging setting No.1 Oldest storage file number [Low-order]	This register stores the oldest storage file number.	○	○	○	R
SD1213	Data logging setting No.1 Oldest storage file number [High-order]					
SD1214	Data logging setting No.1 Internal buffer free space	This register stores the free space size of the internal buffer (K bytes).	○	○	○	R
SD1215	Data logging setting No.1 Number of processing overflow occurrences	This register stores the number of processing overflow occurrences.	○	○	○	R
SD1216	Data logging setting No.1 Data logging error cause	This register stores the data logging error cause. 0: No error Other than 0: Error code	○	○	○	R
SD1220 to SD1226	Data logging setting No.2	Same configuration as the setting No.1	○	○	○	R
SD1230 to SD1236	Data logging setting No.3	Same configuration as the setting No.1	○	○	○	R
SD1240 to SD1246	Data logging setting No.4	Same configuration as the setting No.1	○	○	○	R
SD9300 to SD9303	Data logging setting No.1 to 4 Data logging register/clear error code	The cause of the error that occurred when SM9300 to SM9303 (Data logging register/clear flag) is ON (register)/OFF (clear) is stored. 0: No error Other than 0: Error code	○	○	○	R/W

## Data backup/restoration function

The special registers for data backup/restoration function are shown below.

No.	Name	Description	Compatible CPU module			R/W
			FX5S	FX5UJ	FX5U/ FX5UC	
SD1350	Number of uncompleted folders/files of CPU module data backup/restoration	This register indicates the number of folders/files where the backup/restoration of the CPU module is not completed. When the backup/restoration processing is started, the total number of folders and files to be backed up or restored is stored. The number is reduced one each time one folder/file is backed up or restored, and 0 is stored when all the data is backed up or restored.	○	○	○	R
SD1351	Progression status of CPU module data backup/restoration	This register indicates the progression status of the backup or restoration as a percentage. (Range of the value: 0 to 100 (%)) "0" is set at the start of CPU module data backup/restore.	○	○	○	R

## Mask pattern of interrupt pointers

The special registers for the mask pattern of interrupt pointers are shown below.

No.	Name	Description	Compatible CPU module			R/W
			FX5S	FX5UJ	FX5U/ FX5UC	
SD1400	IMASK instruction mask pattern	This register stores the IMASK instruction mask pattern. b15 to b0: I15 to I0	○	○	○	R
SD1401	IMASK instruction mask pattern	This register stores the IMASK instruction mask pattern. b15 to b0: I31 to I16	○	○	○	R
SD1402	IMASK instruction mask pattern	This register stores the IMASK instruction mask pattern. b15 to b0: I47 to I32	×	○	○	R
SD1403	IMASK instruction mask pattern	This register stores the IMASK instruction mask pattern. b15 to b0: I63 to I48	×	○	○	R
SD1404	IMASK instruction mask pattern	This register stores the IMASK instruction mask pattern. b15 to b0: I79 to I64	×	○	○	R
SD1405	IMASK instruction mask pattern	This register stores the IMASK instruction mask pattern. b15 to b0: I95 to I80	×	○	○	R
SD1406	IMASK instruction mask pattern	This register stores the IMASK instruction mask pattern. b15 to b0: I111 to I96	×	○	○	R
SD1407	IMASK instruction mask pattern	This register stores the IMASK instruction mask pattern. b15 to b0: I127 to I112	×	○	○	R
SD1408	IMASK instruction mask pattern	This register stores the IMASK instruction mask pattern. b15 to b0: I143 to I128	×	○	○	R
SD1409	IMASK instruction mask pattern	This register stores the IMASK instruction mask pattern. b15 to b0: I159 to I144	×	○	○	R
SD1410	IMASK instruction mask pattern	This register stores the IMASK instruction mask pattern. b15 to b0: I175 to I160	×	○	○	R
SD1411	IMASK instruction mask pattern	This register stores the IMASK instruction mask pattern. b15 to b0: I191 to I176	×	○	○	R

A

## Memory dump function

The special registers for memory dump function are shown below.

No.	Name	Description	Compatible CPU module			R/W
			FX5S	FX5UJ	FX5U/ FX5UC	
SD1472	Memory dump error cause	The cause of the error that occurred during the memory dump function is stored. 0: No error Other than 0: Error code	○	○	○	R/W

## Real-time monitor function

The special registers for real-time monitor function are shown below.

No.	Name	Description	Compatible CPU module			R/W
			FX5S	FX5UJ	FX5U/ FX5UC	
SD1484	Real-time monitor internal buffer free space	The amount of free space of the internal buffer is stored in K bytes. The smaller the value, the higher the generating ratio of processing overflow.	○	○	○	R

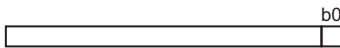

## External input/output forced on/off function

The special registers for the external input/output forced on/off function are shown below.

No.	Name	Description	Compatible CPU module			R/W
			FX5S	FX5UJ	FX5U/ FX5UC	
SD1488	Debug function usage status	The usage status of the debug function is stored using the following bit pattern.  <div style="text-align: center;">  </div> <ul style="list-style-type: none"> <li>• b0: External input/output forced on/off function</li> </ul> Off: Not used On: In use	○	○	○	R

## CC-Link IE Field Network Basic function

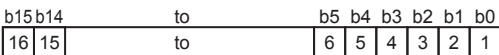
The special registers for CC-Link IE Field Network Basic function are shown below.

No.	Name	Description	Compatible CPU module			R/W
			FX5S	FX5UJ	FX5U/ FX5UC	
SD1536	Cyclic transmission status of each station	The cyclic transmission status of each station is stored using the following bit pattern. (OFF: Not performed, ON: Being performed)  <div style="text-align: center;">  </div> <p>The numbers in the figure indicate station numbers. (Target)</p> <ul style="list-style-type: none"> <li>• FX5S/FX5UJ CPU module: b7 to b0</li> <li>• FX5U/FX5UC CPU module: b15 to b0</li> </ul> <p>(Condition)</p> <ul style="list-style-type: none"> <li>• Only the bit of the start station number turns on.</li> <li>• The status is not stored for the reserved stations and the station numbers after the maximum station number.</li> </ul> Use this register as an interlock for cyclic transmission. For details on the interlock program, refer to the following.  CC-Link IE Field Network Basic Reference Manual	○	○	○	R



No.	Name	Description	Compatible CPU module			R/W
			FX5S	FX5UJ	FX5U/ FX5UC	
SD11127	Diagnosis request information	Specify a remote station number whose diagnostic information is to be displayed. Range <ul style="list-style-type: none"> <li>FX5S/FX5UJ CPU module: 1 to 8</li> <li>FX5U/FX5UC CPU module: 1 to 16</li> </ul>	○	○	○	R/W
SD11128	Diagnostic information status flag	<p>After the END instruction of the scan where the bit 0 of 'Diagnostic information display request' (SD11126) is turned off and on is executed, the status (valid or invalid) of diagnostic information (Diagnostic information 1, Diagnostic information 2) of the remote station specified in 'Diagnostic request information' (SD11127) is stored. (Valid: 1, Invalid: 0)</p> <p>b15                      b8 b7                      b0</p> <div style="border: 1px solid black; width: 100%; height: 15px; margin-bottom: 5px;"></div> <p>b0 to b7: Diagnostic information 1 b8 to b15: Diagnostic information 2</p> <ul style="list-style-type: none"> <li>If the station number of the remote station that is specified in 'Diagnostic request information' (SD11127) is the start station number of the occupied stations and the cyclic transmission is performed for the remote station, 1 is stored in b0 to b7 and b8 to b15. (If the specified remote station is a reserved station, 0 is stored in b8 to b15.)</li> <li>If the station number of the remote station that is specified in 'Diagnostic request information' (SD11127) is other than the start station number of the occupied stations or the cyclic transmission is not performed for the remote station, 0 is stored in b0 to b7 and b8 to b15.</li> <li>When b0 to b7 are valid, the number of occupied stations, group number, IP address, the accumulated number of timeouts, and the accumulated number of disconnection detection are stored in 'Diagnostic request information 1' (SD11129 to SD11140). When b0 to b7 are invalid, 0 is stored in 'Diagnostic request information 1' (SD11129 to SD11140).</li> <li>When b8 to b15 are valid, the Manufacturer code, Model code, device version, module information, error code, and detailed module information are stored in 'Diagnostic request information 2' (SD11144 to SD11153). When b8 to b15 are invalid, 0 is stored in 'Diagnostic request information 2' (SD11144 to SD11153).</li> </ul>	○	○	○	R

No.	Name	Description	Compatible CPU module			R/W									
			FX5S	FX5UJ	FX5U/ FX5UC										
SD11129 to SD11140	Diagnostic information 1	<p>When 1 (valid) is stored in b0 to b7 of SD11128, the number of occupied stations, group number, IP address, the accumulated number of timeouts, and the accumulated number of disconnection detection are stored. When 0 (invalid) is stored in b0 to b7 of SD11128, 0 is stored.</p> <p>■SD11129: Number of occupied stations            ■SD11130: Group number            ■SD11131: IP address (lower)            ■SD11132: IP address (upper)</p> <table border="1" style="margin-left: 40px;"> <tr> <td></td> <td style="text-align: center;">b15 ··· b8</td> <td style="text-align: center;">b7 ··· b0</td> </tr> <tr> <td>SD11131</td> <td style="text-align: center;">3</td> <td style="text-align: center;">4</td> </tr> <tr> <td>SD11132</td> <td style="text-align: center;">1</td> <td style="text-align: center;">2</td> </tr> </table> <p>1 to 4: First octet to fourth octet            When the IP address has not been set in the parameter, 0 is stored.</p> <p>■SD11139: Accumulated number of timeouts            After the END instruction of the scan where the bit 0 of 'Diagnostic information display request' (SD11126) is turned off and on is executed, the accumulated number of timeouts that occurred in a remote station specified in 'Diagnostic request information' (SD11127) is stored.</p> <ul style="list-style-type: none"> <li>• 0: No timeouts</li> <li>• 1 to 65535: Number of timeouts (accumulated number)*2</li> </ul> <p>■SD11140: Accumulated number of disconnection detections            After the END instruction of the scan where the bit 0 of 'Diagnostic information display request' (SD11126) is turned off and on is executed, the accumulated number of disconnections that were detected in a remote station specified in 'Diagnostic request information' (SD11127) is stored.</p> <ul style="list-style-type: none"> <li>• 0: No disconnections</li> <li>• 1 to 65535: Number of disconnection detection (accumulated number)*2</li> </ul>		b15 ··· b8	b7 ··· b0	SD11131	3	4	SD11132	1	2	○	○	○	R
	b15 ··· b8	b7 ··· b0													
SD11131	3	4													
SD11132	1	2													
SD11144 to SD11153	Diagnostic information 2	<p>When Diagnostic information 2 is valid (1 is stored in b8 to b15 of SD11128), the manufacturer code, model code, device version, module information, error code, and detailed module information are stored. When Diagnostic information 2 is invalid (0 is stored in b8 to b15 of SD11128), 0 is stored.</p> <p>■SD11144: Manufacturer code            ■SD11146: Model code (lower)            ■SD11147: Model code (upper)            ■SD11148: Device version            ■SD11150: Module information            ■SD11151: Error code            ■SD11152: Detailed module information (lower)            ■SD11153: Detailed module information (upper)</p>	○	○	○	R									

\*1 This status includes the case where a remote station has not responded to the first request from the master station due to a power-off of the remote station. (The slave station is not judged as a faulty station because the data link status is not determined.)  
 \*2 When the count exceeds 65535, counting is continued from 1 again.



## FX dedicated

The special registers dedicated to FX are shown below.

No.	Name	Description	Compatible CPU module			R/W
			FX5S	FX5UJ	FX5U/ FX5UC	
SD4110 to SD4125	Self-diagnostic error code 1 to 16 details	This register stores the self-diagnosis error code details. <ul style="list-style-type: none"> <li>Module position [Low order 8 bit]            0H: CPU module            1H to 10H: Extension module 1 to 16            41H: Built-in RS-485            42H: Built-in analog            43H: Built-in USB            60H: Expansion board            71H to 76H: Expansion adapter 1 to 6</li> <li>Function No. [Higher order 8 bit]            0: System/Sequence operation            1: Analog input            2: Analog output            10: Positioning, PWM            20: High-speed counter, Pulse width measurement</li> </ul>	○	○	○	R
SD4150, SD4152, SD4154, SD4156, SD4158, SD4160, SD4162, SD4164	Modules 1 to 8 status information	These registers store the modules 1 to 8 status information.	×	○	○	R
SD4151, SD4153, SD4155, SD4157, SD4159, SD4161, SD4163, SD4165	Modules 1 to 8 error information	These registers store the modules 1 to 8 error information.	×	○	○	R
SD4166, SD4168, SD4170, SD4172, SD4174, SD4176, SD4178, SD4180	Modules 9 to 16 status information	These registers store the modules 9 to 16 status information.	×	×	○	R
SD4167, SD4169, SD4171, SD4173, SD4175, SD4177, SD4179, SD4181	Modules 9 to 16 error information	These registers store the modules 9 to 16 error information.	×	×	○	R
SD4210	All module reset command permission code	This register stores the code for permission to reset all modules other than the CPU module. 0H: Reset disable F5F5H: Reset enable (reset execution by turning ON SM4210)	×	○	○	R/W
SD4462	Cumulative operating time [Lower]	This register stores the cumulative operating time (unit: second).	○	○	○	R
SD4463	Cumulative operating time [Upper]					



# High-speed input/output function

The special registers for the high-speed input/output function are shown below.

High-speed counter								
No.	Name	Description	Range	Default	Compatible CPU module			R/W
					FX5S	FX5UJ	FX5U/ FX5UC	
SD4500, SD4530, SD4560, SD4590, SD4620, SD4650, SD4680, SD4710	High-speed counter current value [Low-order] (CH1 to CH8)	This register stores the high-speed counter current value.	-2147483648 to +2147483647	0	○	○	○	R/W
SD4501, SD4531, SD4561, SD4591, SD4621, SD4651, SD4681, SD4711	High-speed counter current value [High-order] (CH1 to CH8)							
SD4502, SD4532, SD4562, SD4592, SD4622, SD4652, SD4682, SD4712	High-speed counter maximum value [Low-order] (CH1 to CH8)	This register stores the high-speed counter maximum value.	-2147483648 to +2147483647	0	○	○	○	R/W
SD4503, SD4533, SD4563, SD4593, SD4623, SD4653, SD4683, SD4713	High-speed counter maximum value [High-order] (CH1 to CH8)							
SD4504, SD4534, SD4564, SD4594, SD4624, SD4654, SD4684, SD4714	High-speed counter minimum value [Low-order] (CH1 to CH8)	This register stores the high-speed counter minimum value.	-2147483648 to +2147483647	0	○	○	○	R/W
SD4505, SD4535, SD4565, SD4595, SD4625, SD4655, SD4685, SD4715	High-speed counter minimum value [High-order] (CH1 to CH8)							
SD4506, SD4536, SD4566, SD4596, SD4626, SD4656, SD4686, SD4716	High-speed counter pulse density [Low-order] (CH1 to CH8)	This register stores the high-speed counter pulse density.	0 to 2147483647	0	○	○	○	R/W
SD4507, SD4537, SD4567, SD4597, SD4627, SD4657, SD4687, SD4717	High-speed counter pulse density [High-order] (CH1 to CH8)							
SD4508, SD4538, SD4568, SD4598, SD4628, SD4658, SD4688, SD4718	High-speed counter rotation speed [Low-order] (CH1 to CH8)	This register stores the high-speed counter rotation speed.	0 to 2147483647	0	○	○	○	R/W
SD4509, SD4539, SD4569, SD4599, SD4629, SD4659, SD4689, SD4719	High-speed counter rotation speed [High-order] (CH1 to CH8)							
SD4510, SD4540, SD4570, SD4600, SD4630, SD4660, SD4690, SD4720	High-speed counter preset control mode (CH1 to CH8)	This register stores the high-speed counter preset control switch.	0: Rising edge	0	○	○	○	R/W
SD4512, SD4542, SD4572, SD4602, SD4632, SD4662, SD4692, SD4722	High-speed counter preset value [Low-order] (CH1 to CH8)	This register stores the high-speed counter preset value.	-2147483648 to +2147483647	Parameter set value	○	○	○	R/W
SD4513, SD4543, SD4573, SD4603, SD4633, SD4663, SD4693, SD4723	High-speed counter preset value [High-order] (CH1 to CH8)							



No.	Name	Description	Range	Default	Compatible CPU module			R/W
					FX5S	FX5UJ	FX5U/ FX5UC	
SD4514, SD4544, SD4574, SD4604, SD4634, SD4664, SD4694, SD4724	High-speed counter ring length [Low-order] (CH1 to CH8)	This register stores the high-speed counter ring length.	2 to 2147483648	Parameter set value	○	○	○	R/W
SD4515, SD4545, SD4575, SD4605, SD4635, SD4665, SD4695, SD4725	High-speed counter ring length [High-order] (CH1 to CH8)							
SD4516, SD4546, SD4576, SD4606, SD4636, SD4666, SD4696, SD4726	High-speed counter measurement-unit time [Low-order] (CH1 to CH8)	This register stores the high-speed counter measurement-unit time.	1 to 2147483647	Parameter set value	○	○	○	R/W
SD4517, SD4547, SD4577, SD4607, SD4637, SD4667, SD4697, SD4727	High-speed counter measurement-unit time [High-order] (CH1 to CH8)							
SD4518, SD4548, SD4578, SD4608, SD4638, SD4668, SD4698, SD4728	High-speed counter number of pulses per rotation [Low-order] (CH1 to CH8)	This register stores the high-speed counter number of pulses per rotation.	1 to 2147483647	Parameter set value	○	○	○	R/W
SD4519, SD4549, SD4579, SD4609, SD4639, SD4669, SD4699, SD4729	High-speed counter number of pulses per rotation [High-order] (CH1 to CH8)							
SD4740, SD4770, SD4800, SD4830, SD4860, SD4890, SD4920, SD4950	High-speed counter current value [Low-order] (CH9 to CH16)	This register stores the high-speed counter current value.	-2147483648 to +2147483647	0	×	○	○	R/W
SD4741, SD4771, SD4801, SD4831, SD4861, SD4891, SD4921, SD4951	High-speed counter current value [High-order] (CH9 to CH16)							
SD4742, SD4772, SD4802, SD4832, SD4862, SD4892, SD4922, SD4952	High-speed counter maximum value [Low-order] (CH9 to CH16)	This register stores the high-speed counter maximum value.	-2147483648 to +2147483647	-2147483648	×	○	○	R/W
SD4743, SD4773, SD4803, SD4833, SD4863, SD4893, SD4923, SD4953	High-speed counter maximum value [High-order] (CH9 to CH16)							
SD4744, SD4774, SD4804, SD4834, SD4864, SD4894, SD4924, SD4954	High-speed counter minimum value [Low-order] (CH9 to CH16)	This register stores the high-speed counter minimum value.	-2147483648 to +2147483647	2147483647	×	○	○	R/W
SD4745, SD4775, SD4805, SD4835, SD4865, SD4895, SD4925, SD4955	High-speed counter minimum value [High-order] (CH9 to CH16)							
SD4750, SD4780, SD4810, SD4840, SD4870, SD4900, SD4930, SD4960	High-speed counter preset control mode (CH9 to CH16)	This register stores the high-speed counter preset control switch.	0: Rising edge	0	×	○	○	R/W
SD4752, SD4782, SD4812, SD4842, SD4872, SD4902, SD4932, SD4962	High-speed counter preset value [Low-order] (CH9 to CH16)	This register stores the high-speed counter preset value.	-2147483648 to +2147483647	Parameter set value	×	○	○	R/W
SD4753, SD4783, SD4813, SD4843, SD4873, SD4903, SD4933, SD4963	High-speed counter preset value [High-order] (CH9 to CH16)							

No.	Name	Description	Range	Default	Compatible CPU module			R/W
					FX5S	FX5UJ	FX5U/ FX5UC	
SD4754, SD4784, SD4814, SD4844, SD4874, SD4904, SD4934, SD4964	High-speed counter ring length [Low-order] (CH9 to CH16)	This register stores the high-speed counter ring length.	2 to 2147483648	Parameter set value	×	○	○	R/W
SD4755, SD4785, SD4815, SD4845, SD4875, SD4905, SD4935, SD4965	High-speed counter ring length [High-order] (CH9 to CH16)							
SD4982	High-speed counter high-speed comparison table error code (CPU module)	This register stores the high-speed comparison table (high-speed compare instruction) error code.	-	-	○	○	○	R/W
SD4986	High-speed counter high-speed comparison table error code (High-speed pulse input/output module first module)				×	○	○	
SD4990	High-speed counter high-speed comparison table error code (High-speed pulse input/output module second module)				×	○	○	
SD4994	High-speed counter high-speed comparison table error code (High-speed pulse input/output module third module)				×	○	○	
SD4998	High-speed counter high-speed comparison table error code (High-speed pulse input/output module fourth module)				×	○	○	
SD5000	High-speed counter multi-point output high-speed comparison table number	This register stores the multi-point output high-speed comparison table comparison number.	-	-	○	○	○	R

## Pulse width measurement

No.	Name	Description	Default	Compatible CPU module			R/W
				FX5S	FX5UJ	FX5U/ FX5UC	
SD5020, SD5040, SD5060, SD5080	Pulse width measurement rising ring counter [Low-order] (CH1 to CH4)	This register stores the pulse width measurement rising ring counter value.	00000000H	○	○	○	R/W
SD5021, SD5041, SD5061, SD5081	Pulse width measurement rising ring counter [High-order] (CH1 to CH4)						
SD5022, SD5042, SD5062, SD5082	Pulse width measurement falling ring counter [Low-order] (CH1 to CH4)	This register stores the pulse width measurement falling ring counter value.	00000000H	○	○	○	R/W
SD5023, SD5043, SD5063, SD5083	Pulse width measurement falling ring counter [High-order] (CH1 to CH4)						

No.	Name	Description	Default	Compatible CPU module			R/W
				FX5S	FX5UJ	FX5U/ FX5UC	
SD5024, SD5044, SD5064, SD5084	Pulse width measurement latest value [Low-order] (CH1 to CH4)	This register stores the pulse width measurement latest value.	00000000H	○	○	○	R/W
SD5025, SD5045, SD5065, SD5085	Pulse width measurement latest value [High-order] (CH1 to CH4)						
SD5026, SD5046, SD5066, SD5086	Pulse width measurement maximum value [Low-order] (CH1 to CH4)	This register stores the pulse width measurement maximum value.	00000000H	○	○	○	R/W
SD5027, SD5047, SD5067, SD5087	Pulse width measurement maximum value [High-order] (CH1 to CH4)						
SD5028, SD5048, SD5068, SD5088	Pulse width measurement minimum value [Low-order] (CH1 to CH4)	This register stores the pulse width measurement minimum value.	FFFFFFFFH	○	○	○	R/W
SD5029, SD5049, SD5069, SD5089	Pulse width measurement minimum value [High-order] (CH1 to CH4)						
SD5030, SD5050, SD5070, SD5090	Pulse width measurement cycle latest value [Low-order] (CH1 to CH4)	This register stores the pulse width measurement cycle latest value.	00000000H	○	○	○	R/W
SD5031, SD5051, SD5071, SD5091	Pulse width measurement cycle latest value [High-order] (CH1 to CH4)						
SD5032, SD5052, SD5072, SD5092	Pulse width measurement cycle maximum value [Low-order] (CH1 to CH4)	This register stores the pulse width measurement cycle maximum value.	00000000H	○	○	○	R/W
SD5033, SD5053, SD5073, SD5093	Pulse width measurement cycle maximum value [High-order] (CH1 to CH4)						
SD5034, SD5054, SD5074, SD5094	Pulse width measurement cycle minimum value [Low-order] (CH1 to CH4)	This register stores the pulse width measurement cycle minimum value.	FFFFFFFFH	○	○	○	R/W
SD5035, SD5055, SD5075, SD5095	Pulse width measurement cycle minimum value [High-order] (CH1 to CH4)						
SD5100, SD5120, SD5140, SD5160, SD5180, SD5200, SD5220, SD5240	Pulse width measurement rising ring counter [Low-order] (CH5 to CH12)	This register stores the pulse width measurement rising ring counter value.	00000000H	×	○	○	R/W
SD5101, SD5121, SD5141, SD5161, SD5181, SD5201, SD5221, SD5241	Pulse width measurement rising ring counter [High-order] (CH5 to CH12)						
SD5102, SD5122, SD5142, SD5162, SD5182, SD5202, SD5222, SD5242	Pulse width measurement falling ring counter [Low-order] (CH5 to CH12)	This register stores the pulse width measurement falling ring counter value.	00000000H	×	○	○	R/W
SD5103, SD5123, SD5143, SD5163, SD5183, SD5203, SD5223, SD5243	Pulse width measurement falling ring counter [High-order] (CH5 to CH12)						
SD5104, SD5124, SD5144, SD5164, SD5184, SD5204, SD5224, SD5244	Pulse width measurement latest value [Low-order] (CH5 to CH12)	This register stores the pulse width measurement latest value.	00000000H	×	○	○	R/W
SD5105, SD5125, SD5145, SD5165, SD5185, SD5205, SD5225, SD5245	Pulse width measurement latest value [High-order] (CH5 to CH12)						

No.	Name	Description	Default	Compatible CPU module			R/W
				FX5S	FX5UJ	FX5U/ FX5UC	
SD5106, SD5126, SD5146, SD5166, SD5186, SD5206, SD5226, SD5246	Pulse width measurement maximum value [Low-order] (CH5 to CH12)	This register stores the pulse width measurement maximum value.	00000000H	×	○	○	R/W
SD5107, SD5127, SD5147, SD5167, SD5187, SD5207, SD5227, SD5247	Pulse width measurement maximum value [High-order] (CH5 to CH12)						
SD5108, SD5128, SD5148, SD5168, SD5188, SD5208, SD5228, SD5248	Pulse width measurement minimum value [Low-order] (CH5 to CH12)	This register stores the pulse width measurement minimum value.	FFFFFFFH	×	○	○	R/W
SD5109, SD5129, SD5149, SD5169, SD5189, SD5209, SD5229, SD5249	Pulse width measurement minimum value [High-order] (CH5 to CH12)						
SD5110, SD5130, SD5150, SD5170, SD5190, SD5210, SD5230, SD5250	Pulse width measurement cycle latest value [Low-order] (CH5 to CH12)	This register stores the pulse width measurement cycle latest value.	00000000H	×	○	○	R/W
SD5111, SD5131, SD5151, SD5171, SD5191, SD5211, SD5231, SD5251	Pulse width measurement cycle latest value [High-order] (CH5 to CH12)						
SD5112, SD5132, SD5152, SD5172, SD5192, SD5212, SD5232, SD5252	Pulse width measurement cycle maximum value [Low-order] (CH5 to CH12)	This register stores the pulse width measurement cycle maximum value.	00000000H	×	○	○	R/W
SD5113, SD5133, SD5153, SD5173, SD5193, SD5213, SD5233, SD5253	Pulse width measurement cycle maximum value [High-order] (CH5 to CH12)						
SD5114, SD5134, SD5154, SD5174, SD5194, SD5214, SD5234, SD5254	Pulse width measurement cycle minimum value [Low-order] (CH5 to CH12)	This register stores the pulse width measurement cycle minimum value.	FFFFFFFH	×	○	○	R/W
SD5115, SD5135, SD5155, SD5175, SD5195, SD5215, SD5235, SD5255	Pulse width measurement cycle minimum value [High-order] (CH5 to CH12)						

## PWM

No.	Name	Description	Default	Compatible CPU module			R/W
				FX5S	FX5UJ	FX5U/ FX5UC	
SD5300, SD5316, SD5332, SD5348	PWM pulse output number [Low-order] (CH1 to CH4)	This register stores the PWM pulse output number.	0	○	○	○	R/W
SD5301, SD5317, SD5333, SD5349	PWM pulse output number [High-order] (CH1 to CH4)						
SD5302, SD5318, SD5334, SD5350	PWM pulse width [Low-order] (CH1 to CH4)	This register stores the PWM pulse width.	0	○	○	○	R/W
SD5303, SD5319, SD5335, SD5351	PWM pulse width [High-order] (CH1 to CH4)						
SD5304, SD5320, SD5336, SD5352	PWM cycle [Low-order] (CH1 to CH4)	This register stores the PWM cycle.	0	○	○	○	R/W
SD5305, SD5321, SD5337, SD5353	PWM cycle [High-order] (CH1 to CH4)						

No.	Name	Description	Default	Compatible CPU module			R/W
				FX5S	FX5UJ	FX5U/ FX5UC	
SD5306, SD5322, SD5338, SD5354	PWM pulse output number current value [Low-order] (CH1 to CH4)	This register stores the PWM pulse output number current value.	0	○	○	○	R
SD5307, SD5323, SD5339, SD5355	PWM pulse output number current value [High-order] (CH1 to CH4)						
SD5364, SD5380, SD5396, SD5412, SD5428, SD5444, SD5460, SD5476	PWM pulse output number [Low-order] (CH5 to CH12)	This register stores the PWM pulse output number.	0	×	○	○	R/W
SD5365, SD5381, SD5397, SD5413, SD5429, SD5445, SD5461, SD5477	PWM pulse output number [High-order] (CH5 to CH12)						
SD5366, SD5382, SD5398, SD5414, SD5430, SD5446, SD5462, SD5478	PWM pulse width [Low-order] (CH5 to CH12)	This register stores the PWM pulse width.	0	×	○	○	R/W
SD5367, SD5383, SD5399, SD5415, SD5431, SD5447, SD5463, SD5479	PWM pulse width [High-order] (CH5 to CH12)						
SD5368, SD5384, SD5400, SD5416, SD5432, SD5448, SD5464, SD5480	PWM cycle [Low-order] (CH5 to CH12)	This register stores the PWM cycle.	0	×	○	○	R/W
SD5369, SD5385, SD5401, SD5417, SD5433, SD5449, SD5465, SD5481	PWM cycle [High-order] (CH5 to CH12)						

## Positioning

No.	Name	Description	Compatible CPU module			R/W
			FX5S	FX5UJ	FX5U/ FX5UC	
SD5500, SD5540, SD5580, SD5620	Positioning current address (user unit) [Low-order] (Axis 1 to Axis 4)	This register stores the current address (user unit) of positioning.	○	○ <sup>*1</sup>	○	R/W
SD5501, SD5541, SD5581, SD5621	Positioning current address (user unit) [High-order] (Axis 1 to Axis 4)					
SD5502, SD5542, SD5582, SD5622	Positioning current address (pulse unit) [Low-order] (Axis 1 to Axis 4)	This register stores the current address (pulse unit) of positioning.	○	○ <sup>*1</sup>	○	R/W
SD5503, SD5543, SD5583, SD5623	Positioning current address (pulse unit) [High-order] (Axis 1 to Axis 4)					
SD5504, SD5544, SD5584, SD5624	Positioning current speed (user unit) [Low- order] (Axis 1 to Axis 4)	This register stores the current speed (user unit) of positioning.	○	○ <sup>*1</sup>	○	R
SD5505, SD5545, SD5585, SD5625	Positioning current speed (user unit) [High- order] (Axis 1 to Axis 4)					
SD5506, SD5546, SD5586, SD5626	Positioning execution table number (Axis 1 to Axis 4)	This register stores the execution table number of positioning.	○	○ <sup>*1</sup>	○	R
SD5510, SD5550, SD5590, SD5630	Positioning error code (Axis 1 to Axis 4)	This register stores the error code of positioning.	○	○ <sup>*1</sup>	○	R/W
SD5511, SD5551, SD5591, SD5631	Positioning error table number (Axis 1 to Axis 4)	This register stores the error table number of positioning.	○	○ <sup>*1</sup>	○	R/W

No.	Name	Description	Compatible CPU module			R/W
			FX5S	FX5UJ	FX5U/ FX5UC	
SD5516, SD5556, SD5596, SD5636	Positioning maximum speed [Low-order] (Axis 1 to Axis 4)	This register stores the maximum speed of positioning.	○	○*1	○	R/W
SD5517, SD5557, SD5597, SD5637	Positioning maximum speed [High-order] (Axis 1 to Axis 4)					
SD5518, SD5558, SD5598, SD5638	Positioning bias speed [Low-order] (Axis 1 to Axis 4)	This register stores the bias speed of positioning.	○	○*1	○	R/W
SD5519, SD5559, SD5599, SD5639	Positioning bias speed [High-order] (Axis 1 to Axis 4)					
SD5520, SD5560, SD5600, SD5640	Positioning acceleration time (Axis 1 to Axis 4)	This register stores the acceleration time of positioning.	○	○*1	○	R/W
SD5521, SD5561, SD5601, SD5641	Positioning deceleration time (Axis 1 to Axis 4)	This register stores the deceleration time of positioning.	○	○*1	○	R/W
SD5526, SD5566, SD5606, SD5646	Positioning zero-return speed [Low-order] (Axis 1 to Axis 4)	This register stores the zero-return speed of positioning.	○	○*1	○	R/W
SD5527, SD5567, SD5607, SD5647	Positioning zero-return speed [High-order] (Axis 1 to Axis 4)					
SD5528, SD5568, SD5608, SD5648	Positioning creep speed [Low-order] (Axis 1 to Axis 4)	This register stores the creep speed of positioning.	○	○*1	○	R/W
SD5529, SD5569, SD5609, SD5649	Positioning creep speed [High-order] (Axis 1 to Axis 4)					
SD5530, SD5570, SD5610, SD5650	Positioning zero-point address [Low-order] (Axis 1 to Axis 4)	This register stores the zero-point address of positioning.	○	○*1	○	R/W
SD5531, SD5571, SD5611, SD5651	Positioning zero-point address [High-order] (Axis 1 to Axis 4)					
SD5532, SD5572, SD5612, SD5652	Positioning number of zero-point signal for zero return (Axis 1 to Axis 4)	This register stores the number of zero-point signal for zero return of positioning.	○	○*1	○	R/W
SD5533, SD5573, SD5613, SD5653	Positioning zero-return dwell time (Axis 1 to Axis 4)	This register stores the zero-return dwell time of positioning.	○	○*1	○	R/W
SD5660, SD5700, SD5740, SD5780, SD5820, SD5860, SD5900, SD5940	Positioning current address (user unit) [Low-order] (Axis 5 to Axis 12)	This register stores the current address (user unit) of positioning.	×	○	○	R/W
SD5661, SD5701, SD5741, SD5781, SD5821, SD5861, SD5901, SD5941	Positioning current address (user unit) [High-order] (Axis 5 to Axis 12)					
SD5662, SD5702, SD5742, SD5782, SD5822, SD5862, SD5902, SD5942	Positioning current address (pulse unit) [Low-order] (Axis 5 to Axis 12)	This register stores the current address (pulse unit) of positioning.	×	○	○	R/W
SD5663, SD5703, SD5743, SD5783, SD5823, SD5863, SD5903, SD5943	Positioning current address (pulse unit) [High-order] (Axis 5 to Axis 12)					
SD5664, SD5704, SD5744, SD5784, SD5824, SD5864, SD5904, SD5944	Positioning current speed (user unit) [Low-order] (Axis 5 to Axis 12)	This register stores the current speed (user unit) of positioning.	×	○	○	R
SD5665, SD5705, SD5745, SD5785, SD5825, SD5865, SD5905, SD5945	Positioning current speed (user unit) [High-order] (Axis 5 to Axis 12)					
SD5666, SD5706, SD5746, SD5786, SD5826, SD5866, SD5906, SD5946	Positioning execution table number (Axis 5 to Axis 12)	This register stores the execution table number of positioning.	×	○	○	R

No.	Name	Description	Compatible CPU module			R/W
			FX5S	FX5UJ	FX5U/ FX5UC	
SD5668, SD5708, SD5748, SD5788, SD5828, SD5868, SD5908, SD5948	Composite speed (user unit) [Low-order] (Axis 5 to Axis 12)	This register stores the current speed (composite speed) of positioning.	×	○	○	R
SD5669, SD5709, SD5749, SD5789, SD5829, SD5869, SD5909, SD5949	Composite speed (user unit) [High-order] (Axis 5 to Axis 12)					
SD5670, SD5710, SD5750, SD5790, SD5830, SD5870, SD5910, SD5950	Positioning error code (Axis 5 to Axis 12)	This register stores the error code of positioning.	×	○	○	R/W
SD5671, SD5711, SD5751, SD5791, SD5831, SD5871, SD5911, SD5951	Positioning error table number (Axis 5 to Axis 12)	This register stores the error table number of positioning.	×	○	○	R/W
SD5676, SD5716, SD5756, SD5796, SD5836, SD5876, SD5916, SD5956	Positioning maximum speed [Low-order] (Axis 5 to Axis 12)	This register stores the maximum speed of positioning.	×	○	○	R/W
SD5677, SD5717, SD5757, SD5797, SD5837, SD5877, SD5917, SD5957	Positioning maximum speed [High-order] (Axis 5 to Axis 12)					
SD5678, SD5718, SD5758, SD5798, SD5838, SD5878, SD5918, SD5958	Positioning bias speed [Low-order] (Axis 5 to Axis 12)	This register stores the bias speed of positioning.	×	○	○	R/W
SD5679, SD5719, SD5759, SD5799, SD5839, SD5879, SD5919, SD5959	Positioning bias speed [High-order] (Axis 5 to Axis 12)					
SD5680, SD5720, SD5760, SD5800, SD5840, SD5880, SD5920, SD5960	Positioning acceleration time (Axis 5 to Axis 12)	This register stores the acceleration time of positioning.	×	○	○	R/W
SD5681, SD5721, SD5761, SD5801, SD5841, SD5881, SD5921, SD5961	Positioning deceleration time (Axis 5 to Axis 12)	This register stores the deceleration time of positioning.	×	○	○	R/W
SD5686, SD5726, SD5766, SD5806, SD5846, SD5886, SD5926, SD5966	Positioning zero-return speed [Low-order] (Axis 5 to Axis 12)	This register stores the zero-return speed of positioning.	×	○	○	R/W
SD5687, SD5727, SD5767, SD5807, SD5847, SD5887, SD5927, SD5967	Positioning zero-return speed [High-order] (Axis 5 to Axis 12)					
SD5688, SD5728, SD5768, SD5808, SD5848, SD5888, SD5928, SD5968	Positioning creep speed [Low-order] (Axis 5 to Axis 12)	This register stores the creep speed of positioning.	×	○	○	R/W
SD5689, SD5729, SD5769, SD5809, SD5849, SD5889, SD5929, SD5969	Positioning creep speed [High-order] (Axis 5 to Axis 12)					



No.	Name	Description	Compatible CPU module			R/W
			FX5S	FX5UJ	FX5U/ FX5UC	
SD5690, SD5730, SD5770, SD5810, SD5850, SD5890, SD5930, SD5970	Positioning zero-point address [Low-order] (Axis 5 to Axis 12)	This register stores the zero-point address of positioning.	×	○	○	R/W
SD5691, SD5731, SD5771, SD5811, SD5851, SD5891, SD5931, SD5971	Positioning zero-point address [High-order] (Axis 5 to Axis 12)					
SD5692, SD5732, SD5772, SD5812, SD5852, SD5892, SD5932, SD5972	Positioning number of zero-point signal for zero return (Axis 5 to Axis 12)	This register stores the number of zero-point signal for zero return of positioning.	×	○	○	R/W
SD5693, SD5733, SD5773, SD5813, SD5853, SD5893, SD5933, SD5973	Positioning zero-return dwell time (Axis 5 to Axis 12)	This register stores the zero-return dwell time of positioning.	×	○	○	R/W

\*1 Only Axis 1 to Axis 3 are supported.

## CPU module built-in analog function

The special registers for the CPU module built-in analog function are shown below.

No. CH1, CH2	Name	Description	Compatible CPU module			R/W
			FX5S	FX5UJ	FX5U/ FX5UC*1	
SD6020, SD6060	Digital output value	This register stores the digital output value.	×	×	○	R
SD6021, SD6061	Digital operation value	This register stores the digital operation value.	×	×	○	R
SD6022, SD6062	Analog input voltage monitor	This register stores the analog input voltage value.	×	×	○	R
SD6023, SD6063	Averaging process setting	This register stores the averaging process setting.	×	×	○	R/W
SD6024, SD6064	Time average/count average/moving average	This register stores the time average/count average/moving average setting.	×	×	○	R/W
SD6026, SD6066	Maximum value	This register stores the maximum value.	×	×	○	R
SD6027, SD6067	Minimum value	This register stores the minimum value.	×	×	○	R
SD6028, SD6068	Scaling upper limit value	This register stores the scaling upper limit value.	×	×	○	R/W
SD6029, SD6069	Scaling lower limit value	This register stores the scaling lower limit value.	×	×	○	R/W
SD6030, SD6070	Shifting amount to conversion value	This register stores the shifting amount of conversion value.	×	×	○	R/W
SD6031, SD6071	Process alarm upper upper limit value	This register stores the process alarm upper upper limit value.	×	×	○	R/W
SD6032, SD6072	Process alarm upper lower limit value	This register stores the process alarm upper lower limit value.	×	×	○	R/W
SD6033, SD6073	Process alarm lower upper limit value	This register stores the process alarm lower upper limit value.	×	×	○	R/W
SD6034, SD6074	Process alarm lower lower limit value	This register stores the process alarm lower lower limit value.	×	×	○	R/W
SD6058, SD6098	A/D latest alarm code	This register stores the latest alarm code.	×	×	○	R
SD6059, SD6099	A/D latest error code	This register stores the latest error code.	×	×	○	R
SD6180	Digital input value	This register stores the digital input value.	×	×	○	R/W
SD6181	Digital operation value	This register stores the digital operation value.	×	×	○	R
SD6182	Analog output voltage monitor	This register stores the analog output voltage value.	×	×	○	R
SD6183	HOLD/CLEAR function setting	This register stores the HOLD/CLEAR setting.	×	×	○	R/W
SD6184	HOLD setting value	This register stores the HOLD setting value.	×	×	○	R/W
SD6188	Scaling upper limit value	This register stores the scaling upper limit value.	×	×	○	R/W
SD6189	Scaling lower limit value	This register stores the scaling lower limit value.	×	×	○	R/W
SD6190	Input value shift amount	This register stores the input value shift amount.	×	×	○	R/W

A

No. CH1, CH2	Name	Description	Compatible CPU module			R/W
			FX5S	FX5UJ	FX5U/ FX5UC*1	
SD6191	Warning output upper limit value	This register stores the warning output upper limit value.	×	×	○	R/W
SD6192	Warning output lower limit value	This register stores the warning output lower limit value.	×	×	○	R/W
SD6218	D/A latest alarm code	This register stores the latest alarm code.	×	×	○	R
SD6219	D/A latest error code	This register stores the latest error code.	×	×	○	R

\*1 Only FX5U CPU module is supported.

## Analog adapter

The special registers for analog adapters are shown below.

Special registers CH1, CH2, CH3, CH4	Connection order	Name	Description	Compatible CPU module			R/W
				FX5S	FX5UJ	FX5U/ FX5UC	
SD6280	1st adapter	Module information	Module information is stored. ■FX5-4A-ADP Stored value: 6180H ■FX5-4AD-ADP Stored value: 6141H ■FX5-4AD-PT-ADP Stored value: 61A1H ■FX5-4AD-TC-ADP Stored value: 61A0H	○	○	○	R
SD6640	2nd adapter			○	○	○	
SD7000	3rd adapter			○	○	○	
SD7360	4th adapter			○	○	○	
SD6290	1st adapter	Module information	Module information is stored. ■FX5-4DA-ADP Stored value: 6161H	○	○	○	R
SD6650	2nd adapter			○	○	○	
SD7010	3rd adapter			○	○	○	
SD7370	4th adapter			○	○	○	
SD6300, SD6340, SD6380, SD6420	1st adapter	Digital output value	The A/D converted digital output value is stored. Target:FX5-4A-ADP (CH1, CH2), FX5-4AD-ADP	○	○	○	R
SD6660, SD6700, SD6740, SD6780	2nd adapter			○	○	○	
SD7020, SD7060, SD7100, SD7140	3rd adapter			○	○	○	
SD7380, SD7420, SD7460, SD7500	4th adapter			○	○	○	
SD6300, SD6340, SD6380, SD6420	1st adapter	Digital value	Set the digital value for D/A conversion. Target:FX5-4A-ADP (CH3, CH4), FX5-4DA-ADP	○	○	○	R
SD6660, SD6700, SD6740, SD6780	2nd adapter			○	○	○	
SD7020, SD7060, SD7100, SD7140	3rd adapter			○	○	○	
SD7380, SD7420, SD7460, SD7500	4th adapter			○	○	○	
SD6300, SD6340, SD6380, SD6420	1st adapter	Measured temperature value	The temperature converted digital output value is stored. Target:FX5-4AD-PT-ADP, FX5-4AD-TC-ADP	○	○	○	R
SD6660, SD6700, SD6740, SD6780	2nd adapter			○	○	○	
SD7020, SD7060, SD7100, SD7140	3rd adapter			○	○	○	
SD7380, SD7420, SD7460, SD7500	4th adapter			○	○	○	

Special registers CH1, CH2, CH3, CH4	Connection order	Name	Description	Compatible CPU module			R/W
				FX5S	FX5UJ	FX5U/ FX5UC	
SD6301, SD6341, SD6381, SD6421	1st adapter	Digital operation value	The digital operation value operated by the scaling function, shift function, and digital clipping function is stored.	○	○	○	R
SD6661, SD6701, SD6741, SD6781	2nd adapter						
SD7021, SD7061, SD7101, SD7141	3rd adapter						
SD7381, SD7421, SD7461, SD7501	4th adapter						
SD6302, SD6342, SD6382, SD6422	1st adapter	Analog input value monitor	The input analog value is stored. Target:FX5-4A-ADP (CH1, CH2), FX5-4AD-ADP	○	○	○	R
SD6662, SD6702, SD6742, SD6782	2nd adapter						
SD7022, SD7062, SD7102, SD7142	3rd adapter						
SD7382, SD7422, SD7462, SD7502	4th adapter						
SD6302, SD6342, SD6382, SD6422	1st adapter	Analog output value monitor	The D/A-converted analog value is stored. • The unit is "1V = 1000mV" for voltage input, and "1mA = 1000mA" for current input. • The upper limit value or lower limit value is stored when the analog value is outside the output range. Range: -10240 to +20479 Default value: 0 Target:FX5-4A-ADP (CH3, CH4), FX5-4DA-ADP	○	○	○	R
SD6662, SD6702, SD6742, SD6782	2nd adapter						
SD7022, SD7062, SD7102, SD7142	3rd adapter						
SD7382, SD7422, SD7462, SD7502	4th adapter						
SD6303, SD6343, SD6383, SD6423	1st adapter	Average processing specification	Set which one between the sampling processing and the averaging processing is to be selected. Target:FX5-4A-ADP (CH1, CH2), FX5-4AD-ADP, FX5-4AD-PT-ADP, FX5-4AD-TC-ADP	○	○	○	R/W
SD6663, SD6703, SD6743, SD6783	2nd adapter						
SD7023, SD7063, SD7103, SD7143	3rd adapter						
SD7383, SD7423, SD7463, SD7503	4th adapter						
SD6303, SD6343, SD6383, SD6423	1st adapter	HOLD/CLEAR function setting	Set whether to hold (HOLD) or clear (CLEAR) the analog output value that was being output when the operation status of the CPU module is STOP or a stop error. Target:FX5-4A-ADP (CH3, CH4), FX5-4DA-ADP	○	○	○	R/W
SD6663, SD6703, SD6743, SD6783	2nd adapter						
SD7023, SD7063, SD7103, SD7143	3rd adapter						
SD7383, SD7423, SD7463, SD7503	4th adapter						
SD6304, SD6344, SD6384, SD6424	1st adapter	Time average/count average/moving average	Set the average time, average counts and moving average counts in the averaging processing for each channel. Target:FX5-4A-ADP (CH1, CH2), FX5-4AD-ADP, FX5-4AD-PT-ADP, FX5-4AD-TC-ADP	○	○	○	R/W
SD6664, SD6704, SD6744, SD6784	2nd adapter						
SD7024, SD7064, SD7104, SD7144	3rd adapter						
SD7384, SD7424, SD7464, SD7504	4th adapter						
SD6304, SD6344, SD6384, SD6424	1st adapter	HOLD setting value	Set the output value when "2: HOLD setting value" is set to the HOLD/CLEAR function setting. Target:FX5-4A-ADP (CH3, CH4), FX5-4DA-ADP	○	○	○	R/W
SD6664, SD6704, SD6744, SD6784	2nd adapter						
SD7024, SD7064, SD7104, SD7144	3rd adapter						
SD7384, SD7424, SD7464, SD7504	4th adapter						



Special registers CH1, CH2, CH3, CH4	Connection order	Name	Description	Compatible CPU module			R/W
				FX5S	FX5UJ	FX5U/ FX5UC	
SD6305, SD6345, SD6385, SD6425	1st adapter	Input range setting	Set the input range. Target:FX5-4A-ADP (CH1, CH2), FX5-4AD-ADP	○	○	○	R/W
SD6665, SD6705, SD6745, SD6785	2nd adapter						
SD7025, SD7065, SD7105, SD7145	3rd adapter						
SD7385, SD7425, SD7465, SD7505	4th adapter						
SD6305, SD6345, SD6385, SD6425	1st adapter	Output range setting	Set the output range. Target:FX5-4A-ADP (CH3, CH4), FX5-4DA-ADP	○	○	○	R/W
SD6665, SD6705, SD6745, SD6785	2nd adapter						
SD7025, SD7065, SD7105, SD7145	3rd adapter						
SD7385, SD7425, SD7465, SD7505	4th adapter						
SD6305, SD6345, SD6385, SD6425	1st adapter	Resistance temperature detector type setting	Set the RTD type. Target:FX5-4AD-PT-ADP	○	○	○	R/W
SD6665, SD6705, SD6745, SD6785	2nd adapter						
SD7025, SD7065, SD7105, SD7145	3rd adapter						
SD7385, SD7425, SD7465, SD7505	4th adapter						
SD6305, SD6345, SD6385, SD6425	1st adapter	Thermocouple type setting	Set the thermocouple type. Target:FX5-4AD-TC-ADP	○	○	○	R/W
SD6665, SD6705, SD6745, SD6785	2nd adapter						
SD7025, SD7065, SD7105, SD7145	3rd adapter						
SD7385, SD7425, SD7465, SD7505	4th adapter						
SD6306, SD6346, SD6386, SD6426	1st adapter	Maximum value	The maximum value of the digital operation value is stored.	○	○	○	R
SD6666, SD6706, SD6746, SD6786	2nd adapter						
SD7026, SD7066, SD7106, SD7146	3rd adapter						
SD7386, SD7426, SD7466, SD7506	4th adapter						
SD6307, SD6347, SD6387, SD6427	1st adapter	Minimum value	The minimum value of the digital operation value is stored.	○	○	○	R
SD6667, SD6707, SD6747, SD6787	2nd adapter						
SD7027, SD7067, SD7107, SD7147	3rd adapter						
SD7387, SD7427, SD7467, SD7507	4th adapter						
SD6308, SD6348, SD6388, SD6428	1st adapter	Scaling upper limit value	Set the upper limit value of the scaling conversion range.	○	○	○	R/W
SD6668, SD6708, SD6748, SD6788	2nd adapter						
SD7028, SD7068, SD7108, SD7148	3rd adapter						
SD7388, SD7428, SD7468, SD7508	4th adapter						

Special registers CH1, CH2, CH3, CH4	Connection order	Name	Description	Compatible CPU module			R/W
				FX5S	FX5UJ	FX5U/ FX5UC	
SD6309, SD6349, SD6389, SD6429	1st adapter	Scaling lower limit value	Set the lower limit value of the scaling conversion range.	○	○	○	R/W
SD6669, SD6709, SD6749, SD6789	2nd adapter						
SD7029, SD7069, SD7109, SD7149	3rd adapter						
SD7389, SD7429, SD7469, SD7509	4th adapter						
SD6310, SD6350, SD6390, SD6430	1st adapter	Conversion value shift amount	Set the "conversion value shift amount" used in the shift function. Target:FX5-4A-ADP (CH1, CH2), FX5-4AD-ADP	○	○	○	R/W
SD6670, SD6710, SD6750, SD6790	2nd adapter						
SD7030, SD7070, SD7110, SD7150	3rd adapter						
SD7390, SD7430, SD7470, SD7510	4th adapter						
SD6310, SD6350, SD6390, SD6430	1st adapter	Input value shift amount	Set the "input value shift amount" used in the shift function. Target:FX5-4A-ADP (CH3, CH4), FX5-4DA-ADP	○	○	○	R/W
SD6670, SD6710, SD6750, SD6790	2nd adapter						
SD7030, SD7070, SD7110, SD7150	3rd adapter						
SD7390, SD7430, SD7470, SD7510	4th adapter						
SD6311, SD6351, SD6391, SD6431	1st adapter	Process alarm upper upper limit value	Set the upper upper limit value of warning output function (process alarm). Target:FX5-4A-ADP (CH1, CH2), FX5-4AD-ADP, FX5-4AD-PT-ADP, FX5-4AD-TC-ADP	○	○	○	R/W
SD6671, SD6711, SD6751, SD6791	2nd adapter						
SD7031, SD7071, SD7111, SD7151	3rd adapter						
SD7391, SD7431, SD7471, SD7511	4th adapter						
SD6311, SD6351, SD6391, SD6431	1st adapter	Warning output upper limit value	Set the upper limit value of the warning output function. Target:FX5-4A-ADP (CH3, CH4), FX5-4DA-ADP	○	○	○	R/W
SD6671, SD6711, SD6751, SD6791	2nd adapter						
SD7031, SD7071, SD7111, SD7151	3rd adapter						
SD7391, SD7431, SD7471, SD7511	4th adapter						
SD6312, SD6352, SD6392, SD6432	1st adapter	Process alarm upper lower limit value	Set the upper lower limit value of warning output function (process alarm). Target:FX5-4A-ADP (CH1, CH2), FX5-4AD-ADP, FX5-4AD-PT-ADP, FX5-4AD-TC-ADP	○	○	○	R/W
SD6672, SD6712, SD6752, SD6792	2nd adapter						
SD7032, SD7072, SD7112, SD7152	3rd adapter						
SD7392, SD7432, SD7472, SD7512	4th adapter						
SD6312, SD6352, SD6392, SD6432	1st adapter	Warning output lower limit value	Set the lower limit value of the warning output function. Target:FX5-4A-ADP (CH3, CH4), FX5-4DA-ADP	○	○	○	R/W
SD6672, SD6712, SD6752, SD6792	2nd adapter						
SD7032, SD7072, SD7112, SD7152	3rd adapter						
SD7392, SD7432, SD7472, SD7512	4th adapter						

Special registers CH1, CH2, CH3, CH4	Connection order	Name	Description	Compatible CPU module			R/W
				FX5S	FX5UJ	FX5U/ FX5UC	
SD6313, SD6353, SD6393, SD6433	1st adapter	Process alarm lower upper limit value	Set the lower upper limit value of warning output function (process alarm).	○	○	○	R/W
SD6673, SD6713, SD6753, SD6793	2nd adapter						
SD7033, SD7073, SD7113, SD7153	3rd adapter						
SD7393, SD7433, SD7473, SD7513	4th adapter						
SD6314, SD6354, SD6394, SD6434	1st adapter	Process alarm lower lower limit value	Set the lower lower limit value of warning output function (process alarm).	○	○	○	R/W
SD6674, SD6714, SD6754, SD6794	2nd adapter						
SD7034, SD7074, SD7114, SD7154	3rd adapter						
SD7394, SD7434, SD7474, SD7514	4th adapter						
SD6315, SD6355, SD6395, SD6435	1st adapter	Rate alarm upper limit value	Set the upper limit of the rate of change of the digital output value for detecting rate alarms.	○	○	○	R/W
SD6675, SD6715, SD6755, SD6795	2nd adapter						
SD7035, SD7075, SD7115, SD7155	3rd adapter						
SD7395, SD7435, SD7475, SD7515	4th adapter						
SD6316, SD6356, SD6396, SD6436	1st adapter	Rate alarm lower limit value	Set the lower limit of the rate of change of the digital output value for detecting rate alarms.	○	○	○	R/W
SD6676, SD6716, SD6756, SD6796	2nd adapter						
SD7036, SD7076, SD7116, SD7156	3rd adapter						
SD7396, SD7436, SD7476, SD7516	4th adapter						
SD6317, SD6357, SD6397, SD6437	1st adapter	Rate alarm warning detection period setting	Set the cycle for checking the rate of change of the digital output value.	○	○	○	R/W
SD6677, SD6717, SD6757, SD6797	2nd adapter						
SD7037, SD7077, SD7117, SD7157	3rd adapter						
SD7397, SD7437, SD7477, SD7517	4th adapter						
SD6318, SD6358, SD6398, SD6438	1st adapter	Conversion setting for disconnection detection	Set the value that is to be stored in the "measured temperature value" when a disconnection is detected.	○	○	○	R/W
SD6678, SD6718, SD6758, SD6798	2nd adapter						
SD7038, SD7078, SD7118, SD7158	3rd adapter						
SD7398, SD7438, SD7478, SD7518	4th adapter						
SD6319, SD6359, SD6399, SD6439	1st adapter	Conversion setting value for disconnection detection	Set the value that is to be stored in the "measured temperature value" when "conversion setting for disconnection detection" is set to "any value".	○	○	○	R/W
SD6679, SD6719, SD6759, SD6799	2nd adapter						
SD7039, SD7079, SD7119, SD7159	3rd adapter						
SD7399, SD7439, SD7479, SD7519	4th adapter						

Special registers CH1, CH2, CH3, CH4	Connection order	Name	Description	Compatible CPU module			R/W
				FX5S	FX5UJ	FX5U/ FX5UC	
SD6322, SD6362, SD6402, SD6442	1st adapter	Convergence detection upper limit value	Set the upper limit of the digital output value used in the convergence detection function.	○	○	○	R/W
SD6682, SD6722, SD6762, SD6802	2nd adapter						
SD7042, SD7082, SD7122, SD7162	3rd adapter						
SD7402, SD7442, SD7482, SD7522	4th adapter						
SD6323, SD6363, SD6403, SD6443	1st adapter	Convergence detection lower limit value	Set the lower limit of the digital output value used in the convergence detection function.	○	○	○	R/W
SD6683, SD6723, SD6763, SD6803	2nd adapter						
SD7043, SD7083, SD7123, SD7163	3rd adapter						
SD7403, SD7443, SD7483, SD7523	4th adapter						
SD6324, SD6364, SD6404, SD6444	1st adapter	Detection time setting for convergence detection	Set the convergence detection time used in the convergence detection function.	○	○	○	R/W
SD6684, SD6724, SD6764, SD6804	2nd adapter						
SD7044, SD7084, SD7124, SD7164	3rd adapter						
SD7404, SD7444, SD7484, SD7524	4th adapter						
SD6325, SD6365, SD6405, SD6445	1st adapter	Deviation detection CH1	Check the status of the deviation between CH detection flag in the 1st and 2nd FX5-4A-ADP, or FX5-4AD-ADP used in the deviation between CH detection function.	○	○	○	R
SD6685, SD6725, SD6765, SD6805	2nd adapter						
SD7045, SD7085, SD7125, SD7165	3rd adapter						
SD7405, SD7445, SD7485, SD7525	4th adapter						
SD6326, SD6366, SD6406, SD6446	1st adapter	Deviation detection CH2	Check the status of the deviation between CH detection flag in the 3rd and 4th FX5-4A-ADP, or FX5-4AD-ADP used in the deviation between CH detection function.	○	○	○	R
SD6686, SD6726, SD6766, SD6806	2nd adapter						
SD7046, SD7086, SD7126, SD7166	3rd adapter						
SD7406, SD7446, SD7486, SD7526	4th adapter						
SD6327, SD6367, SD6407, SD6447	1st adapter	Deviation value for deviation detection between channels	Set the deviation value between channels used in the deviation detection between channel function. Target:FX5-4A-ADP (CH1, CH2), FX5-4AD-ADP	○	○	○	R/W
SD6687, SD6727, SD6767, SD6807	2nd adapter						
SD7047, SD7087, SD7127, SD7167	3rd adapter						
SD7407, SD7447, SD7487, SD7527	4th adapter						
SD6327, SD6367, SD6407, SD6447	1st adapter	Offset temperature setting value	Set the offset temperature setting value used in the offset/gain setting function. Target:FX5-4AD-PT-ADP, FX5-4AD-TC-ADP	○	○	○	R/W
SD6687, SD6727, SD6767, SD6807	2nd adapter						
SD7047, SD7087, SD7127, SD7167	3rd adapter						
SD7407, SD7447, SD7487, SD7527	4th adapter						



Special registers CH1, CH2, CH3, CH4	Connection order	Name	Description	Compatible CPU module			R/W
				FX5S	FX5UJ	FX5U/ FX5UC	
SD6328, SD6368, SD6408, SD6448	1st adapter	CH setting 1 for deviation detection between channel	Set the channels whose deviation will be checked in the 1st and 2nd FX5-4A-ADP, or FX5-4AD-ADP used in the deviation detection between channel function.	○	○	○	R/W
SD6688, SD6728, SD6768, SD6808	2nd adapter						
SD7048, SD7088, SD7128, SD7168	3rd adapter						
SD7408, SD7448, SD7488, SD7528	4th adapter						
SD6328, SD6368, SD6408, SD6448	1st adapter	Gain temperature setting value	Set the gain temperature setting value used in the offset/gain setting function. Target:FX5-4AD-PT-ADP, FX5-4AD-TC-ADP	○	○	○	R/W
SD6688, SD6728, SD6768, SD6808	2nd adapter						
SD7048, SD7088, SD7128, SD7168	3rd adapter						
SD7408, SD7448, SD7488, SD7528	4th adapter						
SD6329, SD6369, SD6409, SD6449	1st adapter	CH setting 2 for deviation detection between channel	Set the channels whose deviation will be checked in the 3rd and 4th FX5-4A-ADP, or FX5-4AD-ADP used in the deviation detection between channel function. * Only the FX5S/FX5U/FX5UC CPU module is supported.	○	○	○	R/W
SD6689, SD6729, SD6769, SD6809	2nd adapter						
SD7049, SD7089, SD7129, SD7169	3rd adapter						
SD7409, SD7449, SD7489, SD7529	4th adapter						
SD6329, SD6369, SD6409, SD6449	1st adapter	Offset/gain writing enable code	Set the offset/gain writing enable code used for changing the offset/gain. Target:FX5-4AD-PT-ADP, FX5-4AD-TC-ADP	○	○	○	R/W
SD6689, SD6729, SD6769, SD6809	2nd adapter						
SD7049, SD7089, SD7129, SD7169	3rd adapter						
SD7409, SD7449, SD7489, SD7529	4th adapter						
SD6330, SD6370, SD6410, SD6450	1st adapter	Resistance offset value (L)	The resistance offset value calculated based on the "offset temperature setting value" and "setting RTD type" is stored. When "offset/gain reading" is set from OFF to ON or the power supply of the FX5-4AD-PT-ADP is turned off and on, the resistance offset value, which is calculated based on the "offset temperature setting value" and "setting RTD type" obtained from the built-in memory of the FX5-4AD-PT-ADP, is stored. Target:FX5-4AD-PT-ADP	○	○	○	R/W
SD6690, SD6730, SD6770, SD6810	2nd adapter						
SD7050, SD7090, SD7130, SD7170	3rd adapter						
SD7410, SD7450, SD7490, SD7530	4th adapter						
SD6330, SD6370, SD6410, SD6450	1st adapter	Thermal EMF offset value (L)	The thermal EMF offset value calculated based on the "offset temperature setting value" and "setting thermocouple type" is stored. When "offset/gain reading" is set from OFF to ON or the power supply of the FX5-4AD-TC-ADP is turned off and on, the thermal EMF offset value, which is calculated based on the offset temperature setting value and setting thermocouple type obtained from the built-in memory of the FX5-4AD-TC-ADP, is stored. Target:FX5-4AD-TC-ADP	○	○	○	R/W
SD6690, SD6730, SD6770, SD6810	2nd adapter						
SD7050, SD7090, SD7130, SD7170	3rd adapter						
SD7410, SD7450, SD7490, SD7530	4th adapter						



Special registers CH1, CH2, CH3, CH4	Connection order	Name	Description	Compatible CPU module			R/W
				FX5S	FX5UJ	FX5U/ FX5UC	
SD6331, SD6371, SD6411, SD6451	1st adapter	Resistance offset value (H)	The resistance offset value calculated based on the "offset temperature setting value" and "setting RTD type" is stored. When "offset/gain reading" is set from OFF to ON or the power supply of the FX5-4AD-PT-ADP is turned off and on, the resistance offset value, which is calculated based on the "offset temperature setting value" and "setting RTD type" obtained from the built-in memory of the FX5-4AD-PT-ADP, is stored. Target:FX5-4AD-PT-ADP	○	○	○	R/W
SD6691, SD6731, SD6771, SD6811	2nd adapter						
SD7051, SD7091, SD7131, SD7171	3rd adapter						
SD7411, SD7451, SD7491, SD7531	4th adapter						
SD6331, SD6371, SD6411, SD6451	1st adapter	Thermal EMF offset value (H)	The thermal EMF offset value calculated based on the "offset temperature setting value" and "setting thermocouple type" is stored. When "offset/gain reading" is set from OFF to ON or the power supply of the FX5-4AD-TC-ADP is turned off and on, the thermal EMF offset value, which is calculated based on the offset temperature setting value and setting thermocouple type obtained from the built-in memory of the FX5-4AD-TC-ADP, is stored. Target:FX5-4AD-TC-ADP	○	○	○	R/W
SD6691, SD6731, SD6771, SD6811	2nd adapter						
SD7051, SD7091, SD7131, SD7171	3rd adapter						
SD7411, SD7451, SD7491, SD7531	4th adapter						
SD6332, SD6372, SD6412, SD6452	1st adapter	Offset setting value	Set the offset data used in the offset/gain setting function. Target:FX5-4A-ADP, FX5-4AD-ADP, FX5-4DA-ADP	○	○	○	R/W
SD6692, SD6732, SD6772, SD6812	2nd adapter						
SD7052, SD7092, SD7132, SD7172	3rd adapter						
SD7412, SD7452, SD7492, SD7532	4th adapter						
SD6332, SD6372, SD6412, SD6452	1st adapter	Resistance gain value (L)	The resistance gain value calculated based on the "gain temperature setting value" and "setting RTD type" is stored. When "offset/gain reading" is set from OFF to ON or the power supply of the FX5-4AD-PT-ADP is turned off and on, the resistance gain value, which is calculated based on the "gain temperature setting value" and "setting RTD type" obtained from the built-in memory of the FX5-4AD-PT-ADP, is stored. Target:FX5-4AD-PT-ADP	○	○	○	R/W
SD6692, SD6732, SD6772, SD6812	2nd adapter						
SD7052, SD7092, SD7132, SD7172	3rd adapter						
SD7412, SD7452, SD7492, SD7532	4th adapter						
SD6332, SD6372, SD6412, SD6452	1st adapter	Thermal EMF gain value (L)	The thermal EMF gain value calculated based on the "gain temperature setting value" and "setting thermocouple type" is stored. When "offset/gain reading" is set from OFF to ON or the power supply of the FX5-4AD-TC-ADP is turned off and on, the thermal EMF gain value, which is calculated based on the gain temperature setting value and setting thermocouple type obtained from the built-in memory of the FX5-4AD-TC-ADP, is stored. Target:FX5-4AD-TC-ADP	○	○	○	R/W
SD6692, SD6732, SD6772, SD6812	2nd adapter						
SD7052, SD7092, SD7132, SD7172	3rd adapter						
SD7412, SD7452, SD7492, SD7532	4th adapter						
SD6333, SD6373, SD6413, SD6453	1st adapter	Gain setting value	Set the gain data used in the offset/gain setting function. Target:FX5-4A-ADP, FX5-4AD-ADP, FX5-4DA-ADP	○	○	○	R/W
SD6693, SD6733, SD6773, SD6813	2nd adapter						
SD7053, SD7093, SD7133, SD7173	3rd adapter						
SD7413, SD7453, SD7493, SD7533	4th adapter						



Special registers CH1, CH2, CH3, CH4	Connection order	Name	Description	Compatible CPU module			R/W
				FX5S	FX5UJ	FX5U/ FX5UC	
SD6333, SD6373, SD6413, SD6453	1st adapter	Resistance gain value (H)	The resistance gain value calculated based on the "gain temperature setting value" and "setting RTD type" is stored. When "offset/gain reading" is set from OFF to ON or the power supply of the FX5-4AD-PT-ADP is turned off and on, the resistance gain value, which is calculated based on the "gain temperature setting value" and "setting RTD type" obtained from the built-in memory of the FX5-4AD-PT-ADP, is stored. Target:FX5-4AD-PT-ADP	○	○	○	R/W
SD6693, SD6733, SD6773, SD6813	2nd adapter						
SD7053, SD7093, SD7133, SD7173	3rd adapter						
SD7413, SD7453, SD7493, SD7533	4th adapter						
SD6333, SD6373, SD6413, SD6453	1st adapter	Thermal EMF gain value (H)	The thermal EMF gain value calculated based on the "gain temperature setting value" and "setting thermocouple type" is stored. When "offset/gain reading" is set from OFF to ON or the power supply of the FX5-4AD-TC-ADP is turned off and on, the thermal EMF gain value, which is calculated based on the gain temperature setting value and setting thermocouple type obtained from the built-in memory of the FX5-4AD-TC-ADP, is stored. Target:FX5-4AD-TC-ADP	○	○	○	R/W
SD6693, SD6733, SD6773, SD6813	2nd adapter						
SD7053, SD7093, SD7133, SD7173	3rd adapter						
SD7413, SD7453, SD7493, SD7533	4th adapter						
SD6334, SD6374, SD6414, SD6454	1st adapter	Offset/gain writing enable code	Set the offset/gain writing enable code used for changing the offset/gain. Target:FX5-4A-ADP, FX5-4AD-ADP, FX5-4DA-ADP	○	○	○	R
SD6694, SD6734, SD6774, SD6814	2nd adapter						
SD7054, SD7094, SD7134, SD7174	3rd adapter						
SD7414, SD7454, SD7494, SD7534	4th adapter						
SD6334, SD6374, SD6414, SD6454	1st adapter	Input offset value (L)	Set the offset value used in the offset/gain setting function. Target:FX5-4AD-PT-ADP, FX5-4AD-TC-ADP	○	○	○	R
SD6694, SD6734, SD6774, SD6814	2nd adapter						
SD7054, SD7094, SD7134, SD7174	3rd adapter						
SD7414, SD7454, SD7494, SD7534	4th adapter						
SD6335, SD6375, SD6415, SD6455	1st adapter	Input offset value (H)	Set the offset value used in the offset/gain setting function.	○	○	○	R/W
SD6695, SD6735, SD6775, SD6815	2nd adapter						
SD7055, SD7095, SD7135, SD7175	3rd adapter						
SD7415, SD7455, SD7495, SD7535	4th adapter						
SD6336, SD6376, SD6416, SD6456	1st adapter	Input gain value (L)	Set the gain value used in the offset/gain setting function.	○	○	○	R/W
SD6696, SD6736, SD6776, SD6816	2nd adapter						
SD7056, SD7096, SD7136, SD7176	3rd adapter						
SD7416, SD7456, SD7496, SD7536	4th adapter						

Special registers CH1, CH2, CH3, CH4	Connection order	Name	Description	Compatible CPU module			R/W
				FX5S	FX5UJ	FX5U/ FX5UC	
SD6337, SD6377, SD6417, SD6457	1st adapter	Input gain value (H)	Set the gain value used in the offset/gain setting function.	○	○	○	R/W
SD6697, SD6737, SD6777, SD6817	2nd adapter						
SD7057, SD7097, SD7137, SD7177	3rd adapter						
SD7417, SD7457, SD7497, SD7537	4th adapter						
SD6338, SD6378, SD6418, SD6458	1st adapter	A/D conversion latest alarm code	The latest alarm code detected by the analog adapter is stored. Default value: 0 Set the "A/D conversion alarm clear request" from OFF to ON to clear the alarm code. Target:FX5-4A-ADP (CH1, CH2), FX5-4AD-ADP	○	○	○	R
SD6698, SD6738, SD6778, SD6818	2nd adapter						
SD7058, SD7098, SD7138, SD7178	3rd adapter						
SD7418, SD7458, SD7498, SD7538	4th adapter						
SD6338, SD6378, SD6418, SD6458	1st adapter	D/A conversion latest alarm code	The latest alarm code detected by the analog adapter is stored. Default value: 0 Set the "D/A conversion alarm clear request" from OFF to ON to clear the alarm code. Target:FX5-4A-ADP (CH3, CH4), FX5-4DA-ADP	○	○	○	R
SD6698, SD6738, SD6778, SD6818	2nd adapter						
SD7058, SD7098, SD7138, SD7178	3rd adapter						
SD7418, SD7458, SD7498, SD7538	4th adapter						
SD6338, SD6378, SD6418, SD6458	1st adapter	Conversion latest alarm code	The latest alarm code detected by the analog adapter is stored. Default value: 0 Set the "conversion alarm clear request" from OFF to ON to clear the alarm code. Target:FX5-4AD-PT-ADP, FX5-4AD-TC-ADP	○	○	○	R
SD6698, SD6738, SD6778, SD6818	2nd adapter						
SD7058, SD7098, SD7138, SD7178	3rd adapter						
SD7418, SD7458, SD7498, SD7538	4th adapter						
SD6339, SD6379, SD6419, SD6459	1st adapter	A/D conversion latest error code	The latest error code detected by the analog adapter is stored. Default value: 0 To clear the error code, turn off and on "error clear request" (SM50) of the CPU module. Target:FX5-4A-ADP (CH1, CH2), FX5-4AD-ADP	○	○	○	R
SD6699, SD6739, SD6779, SD6819	2nd adapter						
SD7059, SD7099, SD7139, SD7179	3rd adapter						
SD7419, SD7459, SD7499, SD7539	4th adapter						
SD6339, SD6379, SD6419, SD6459	1st adapter	D/A conversion latest error code	The latest error code detected by the analog adapter is stored. Default value: 0 To clear the error code, turn off and on "error clear request" (SM50) of the CPU module. Target:FX5-4A-ADP (CH3, CH4), FX5-4DA-ADP	○	○	○	R
SD6699, SD6739, SD6779, SD6819	2nd adapter						
SD7059, SD7099, SD7139, SD7179	3rd adapter						
SD7419, SD7459, SD7499, SD7539	4th adapter						
SD6339, SD6379, SD6419, SD6459	1st adapter	Conversion latest error code	The latest error code detected by the analog adapter is stored. Default value: 0 To clear the error code, turn off and on "error clear request" (SM50) of the CPU module. Target:FX5-4AD-PT-ADP, FX5-4AD-TC-ADP	○	○	○	R
SD6699, SD6739, SD6779, SD6819	2nd adapter						
SD7059, SD7099, SD7139, SD7179	3rd adapter						
SD7419, SD7459, SD7499, SD7539	4th adapter						

## FX compatible area

The special registers for FX compatible area are shown below.

No.	Name	Description	Compatible CPU module			R/W
			FX5S	FX5UJ	FX5U/ FX5UC	
SD8000	Watchdog timer	This register stores the watchdog timer.	○	○	○	R/W
SD8001	PLC type and system version	This register stores the PLC type and system version.	○	○	○	R
SD8005	Battery voltage	This register stores the battery voltage. (units: 0.1 V)	×	×	○	R
SD8006	Low battery voltage	This register stores the low battery voltage. (units: 0.1 V)	×	×	○	R/W
SD8007	Power failure count	This register stores the power failure count.	×	○	○	R
SD8008	Power failure detection period	This register stores the power failure detection period. When the power supply voltage is 200 V AC, the time can be change to 10 to 100 ms.	×	○	○	R
SD8010	Current scan time	This register stores the current scan time. (units: 0.1 ms)	○	○	○	R
SD8011	Minimum scan time	This register stores the minimum scan time. (units: 0.1 ms)	○	○	○	R
SD8012	Maximum scan time	This register stores the maximum scan time. (units: 0.1 ms)	○	○	○	R
SD8013	RTC: Seconds	This register stores the seconds data.	○	○	○	R/W
SD8014	RTC: Minute data	This register stores the minute data.	○	○	○	R/W
SD8015	RTC: Hour data	This register stores the hour data.	○	○	○	R/W
SD8016	RTC: Day data	This register stores the day data.	○	○	○	R/W
SD8017	RTC: Month data	This register stores the month data.	○	○	○	R/W
SD8018	RTC: Year data	This register stores the year data.	○	○	○	R/W
SD8019	RTC: Day of week data	This register stores the day of week data.	○	○	○	R/W
SD8039	Constant scan duration	This register stores the constant scan duration. 0 to 2000 (unit: 1 ms)	○	○	○	R/W
SD8040 to SD8047*1	STL: ON state numbers 1 to 8	These registers store the ON state numbers 1 to 8.	○	○	○	R/W
SD8049	Lowest active Annunciator	This register stores the lowest active annunciator.	○	○	○	R/W
SD8063	Serial communication error code (CH1)	This register stores the serial communication error code (CH1).	○	○	○	R
SD8067	Operation error	This register stores the error code number of operation error.	○	○	○	R
SD8099	High speed ring counter	This register stores the high speed ring counter count value. (units: 0.1 ms)	○	○	○	R/W
SD8136	PLSY Output number [Low-order]	This register stores the PLSY instruction output pulse number.	○	○	○	R
SD8137	PLSY Output number [High-order]					
SD8140	PLSY Accumulated number of pulses output [Low-order] (axis 1)	This register stores the PLSY instruction accumulated number of pulses output (to axis 1).	○	○	○	R
SD8141	PLSY Accumulated number of pulses output [High-order] (axis 1)					
SD8142	PLSY Accumulated number of pulses output [Low-order] (axis 2)	This register stores the PLSY instruction accumulated number of pulses output (to axis 2).	○	○	○	R
SD8143	PLSY Accumulated number of pulses output [High-order] (axis 2)					
SD8152, SD8157	Inverter communication error codes (CH1, CH2)	These registers store the inverter communication error codes (CH1, CH2).	○	○	○	R
SD8154, SD8159	IVBWR instruction error parameter numbers (CH1, CH2)	These registers store the IVBWR instruction error parameter numbers (CH1, CH2).	○	○	○	R

No.	Name	Description	Compatible CPU module			R/W
			FX5S	FX5UJ	FX5U/ FX5UC	
SD8166	Module error occurrence conditions (Module connection position 1 to 15)	b0: No error b1: Module connection No.1 b2: Module connection No.2 b3: Module connection No.3 b4: Module connection No.4 b5: Module connection No.5 b6: Module connection No.6 b7: Module connection No.7 b8: Module connection No.8 b9: Module connection No.9 b10: Module connection No.10 <sup>*2</sup> b11: Module connection No.11 <sup>*2</sup> b12: Module connection No.12 <sup>*2</sup> b13: Module connection No.13 <sup>*2</sup> b14: Module connection No.14 <sup>*2</sup> b15: Module connection No.15 <sup>*2</sup> 0: No error 1: Error	×	○	○	R
SD8167	Module error occurrence conditions (Module connection position 16 to 18)	b0: Module connection No.16 b1: Module connection No.17 b2: Module connection No.18 0: No error 1: Error	×	×	○	R
SD8173	Station number	This register stores the station number.	○	○	○	R/W
SD8174	Total number of slave stations	This register stores the total number of slave stations.	○	○	○	R/W
SD8175	Refresh range	This register stores the refresh range.	○	○	○	R
SD8201	Current link scan time	This register stores the current link scan time.	○	○	○	R
SD8202	Maximum link scan time	This register stores the maximum link scan time.	○	○	○	R
SD8203	Number of communication error at master station	This register stores the number of communication error at master station.	○	○	○	R
SD8204 to SD8210	Number of communication error at slave station No.1 to No.7	These registers store the number of communication error at slave station No.1 to No.7.	○	○	○	R
SD8211	Code of communication error at master station	This register stores the code of communication error at master station.	○	○	○	R
SD8212 to SD8218	Code of communication error at slave station No.1 to No.7	These registers store the code of communication error at slave station No.1 to No.7.	○	○	○	R
SD8310	RND Random number generation [Low-order]	This register stores the RND random number generation data.	○	○	○	R
SD8311	RND Random number generation [High-order]					
SD8330 to SD8334	Counted number of scans for timing clock outputs 1 to 5	These registers store the scan count for timing clock outputs 1 to 5.	○	○	○	R
SD8340, SD8350, SD8360, SD8370	Current address [Low-order] (axes 1 to 4: pulse units)	These registers store the current address (axes 1 to 4: pulse units).	○	○	○	R
SD8341, SD8351, SD8361, SD8371	Current address [High-order] (axes 1 to 4: pulse units)					
SD8393	Delay time	The input interrupt delay function for identifying pattern programs	○	○	○	R/W
SD8398	1 ms ring counter [Low-order]	This register stores the 1 ms ring counter.	○	○	○	R
SD8399	1 ms ring counter [High-order]					
SD8402, SD8422	RS2 amount of remaining data (CH1, CH2)/MODBUS communication error code (CH1, CH2)	These registers store the amount of remaining data (CH1, CH2)/MODBUS communication error codes (CH1, CH2).	○	○	○	R
SD8403, SD8423	RS2 receive data points (CH1, CH2)/MODBUS communication error details (CH1, CH2)	These registers store the receive data points (CH1, CH2)/MODBUS communication error details (CH1, CH2).	○	○	○	R

No.	Name	Description	Compatible CPU module			R/W
			FX5S	FX5UJ	FX5U/ FX5UC	
SD8405, SD8425	RS2 communication parameter display (CH1, CH2)/MODBUS communication format display (CH1, CH2)	These registers store the communication parameter display (CH1, CH2)/MODBUS communication format display (CH1, CH2).	○	○	○	R
SD8408, SD8428	MODBUS communication retry times (CH1, CH2)	These registers store the MODBUS communication current retry times (CH1, CH2).	○	○	○	R
SD8414, SD8434	RS2 receive sum (received data) (CH1, CH2)	These registers store the receive sum (received data) (CH1, CH2).	○	○	○	R
SD8415, SD8435	RS2 receive sum (calculated results) (CH1, CH2)	These registers store the receive sum (received results) (CH1, CH2).	○	○	○	R
SD8416, SD8436	RS2 send sum (CH1, CH2)	These registers store the send sum (CH1, CH2).	○	○	○	R
SD8419, SD8439	Operation mode (CH1, CH2)	These registers store the operation mode (CH1, CH2).	○	○	○	R
SD8438	Serial communication error code (CH2)	This register stores the serial communication error code (CH2).	○	○	○	R
SD8492	IP address setting [Low-order]	This register stores the IP address.	○	○	○	R/W
SD8493	IP address setting [High-order]					
SD8494	Subnet mask setting [Low-order]	This register stores the subnet mask.	○	○	○	R/W
SD8495	Subnet mask setting [High-order]					
SD8496	Default gateway IP address setting [Low-order]	This register stores the default gateway IP address.	○	○	○	R/W
SD8497	Default gateway IP address setting [High-order]					
SD8498	IP address storage area write error code	This register stores error codes if writing to IP address storage area is failed.	○	○	○	R
SD8499	IP address storage area clear error code	This register stores error codes if clear to IP address storage area is failed.	○	○	○	R

\*1 Enabled only when the STL instruction is used.

\*2 Only FX5U/FX5UC CPU module is supported.

## Serial communication function

The special registers for the serial communication function are shown below.

No.	Name	Description	Compatible CPU module			R/W
			FX5S	FX5UJ	FX5U/ FX5UC*1	
SD8500	Serial communication error code (CH1)	This register stores the serial communication error code 1 (CH1).	×	×	○	R
SD8501	Serial communication error details (CH1)	This register stores the serial communication error details 1 (CH1).	×	×	○	R
SD8502	Serial communication setting (CH1)	This register stores the serial communication setting (CH1).	×	×	○	R
SD8503	Serial communication operational mode (CH1)	This register stores the serial communication operational mode 1 (CH1).	×	×	○	R
SD8510, SD8520, SD8530	Serial communication error code (CH2 to CH4)	These registers store the serial communication error code 2 (CH2 to CH4).	○	○	○	R
SD8511, SD8521, SD8531	Serial communication error details (CH2 to CH4)	These registers store the serial communication error details 2 (CH2 to CH4).	○	○	○	R
SD8512, SD8522, SD8532	Serial communication setting (CH2 to CH4)	These registers store the serial communication setting (CH2 to CH4).	○	○	○	R
SD8513, SD8523, SD8533	Serial communication operational mode (CH2 to CH4)	These registers store the serial communication operational mode 2 (CH2 to CH4).	○	○	○	R
SD8560	Remaining points of send data (CH1)	This register stores the remaining points of send data (CH1).	×	×	○	R
SD8561	Receive data points monitor (CH1)	This register stores the receive data points monitor (CH1).	×	×	○	R
SD8563	Receive sum (received data) (CH1)	This register stores the receive sum (received data) (CH1).	×	×	○	R

No.	Name	Description	Compatible CPU module			R/W
			FX5S	FX5UJ	FX5U/ FX5UC*1	
SD8564	Receive sum (received result) (CH1)	This register stores the receive sum (received result) (CH1).	×	×	○	R
SD8565	Send sum (CH1)	This register stores the send sum (CH1).	×	×	○	R
SD8570, SD8580, SD8590	Remaining points of send data (CH2 to CH4)	These registers store the remaining points of send data (CH2 to CH4).	○	○	○	R
SD8571, SD8581, SD8591	Receive data points monitor (CH2 to CH4)	These registers store the receive data points monitor (CH2 to CH4).	○	○	○	R
SD8573, SD8583, SD8593	Receive sum (received data) (CH2 to CH4)	These registers store the receive sum (received data) (CH2 to CH4).	○	○	○	R
SD8574, SD8584, SD8594	Receive sum (received results) (CH2 to CH4)	These registers store the receive sum (received results) (CH2 to CH4).	○	○	○	R
SD8575, SD8585, SD8595	Send sum (CH2 to CH4)	These registers store the send sum (CH2 to CH4).	○	○	○	R
SD8621	Timeout time (CH1)	This register stores the timeout time (CH1).	×	×	○	R
SD8622	8-bit processing mode (CH1)	This register stores the 8-bit processing mode (CH1).	×	×	○	R
SD8623	Header 1 and 2 (CH1)	This register stores the header 1 and 2 (CH1).	×	×	○	R
SD8624	Header 3 and 4 (CH1)	This register stores the header 3 and 4 (CH1).	×	×	○	R
SD8625	Terminator 1 and 2 (CH1)	This register stores the terminator 1 and 2 (CH1).	×	×	○	R
SD8626	Terminator 3 and 4 (CH1)	This register stores the terminator 3 and 4 (CH1).	×	×	○	R
SD8631, SD8641, SD8651	Timeout time (CH2 to CH4)	These registers store the timeout time (CH2 to CH4).	○	○	○	R
SD8632, SD8642, SD8652	8-bit processing mode (CH2 to CH4)	These registers store the 8-bit processing mode (CH2 to CH4).	○	○	○	R
SD8633, SD8643, SD8653	Headers 1 and 2 (CH2 to CH4)	These registers store the headers 1 and 2 (CH2 to CH4).	○	○	○	R
SD8634, SD8644, SD8654	Headers 3 and 4 (CH2 to CH4)	These registers store the headers 3 and 4 (CH2 to CH4).	○	○	○	R
SD8635, SD8645, SD8655	Terminators 1 and 2 (CH2 to CH4)	These registers store the terminators 1 and 2 (CH2 to CH4).	○	○	○	R
SD8636, SD8646, SD8656	Terminators 3 and 4 (CH2 to CH4)	These registers store the terminators 3 and 4 (CH2 to CH4).	○	○	○	R
SD8740	Station number setting (CH1)	This register stores the station number setting (CH1).	×	×	○	*2
SD8741	Message frame and form (CH1)	This register stores the message frame and form (CH1).	×	×	○	R
SD8742	Timeout time (CH1)	This register stores the timeout time (CH1).	×	×	○	R
SD8744	Message waiting time (CH1)	Message waiting time (CH1) is stored.	×	×	○	R
SD8750, SD8760, SD8770	Station number setting (CH2 to CH4)	These registers store the station number setting (CH2 to CH4).	○	○	○	*2
SD8751, SD8761, SD8771	Message frame and form (CH2 to CH4)	These registers store the message frame and form (CH2 to CH4).	○	○	○	R
SD8752, SD8762, SD8772	Timeout time (CH2 to CH4)	These registers store the timeout time (CH2 to CH4).	○	○	○	R
SD8754, SD8764, SD8774	Message waiting time (CH2 to CH4)	These registers store the message waiting time (CH2 to CH4).	○	○	○	R
SD8800	Current retry value (CH1)	This register stores the current retry value (CH1).	×	×	○	R
SD8810, SD8820, SD8830	Current retry value (CH2 to CH4)	These registers store the current retry value (CH2 to CH4).	×	×	○	R
SD8861	Slave node address (CH1)	This register stores the host station number (CH1).	×	×	○	R/W
SD8862	Slave response timeout (CH1)	This register stores the slave response timeout (CH1).	×	×	○	R
SD8863	Turn around delay (CH1)	This register stores the broadcast delay (CH1).	×	×	○	R
SD8864	Message to message delay (CH1)	This register stores the request to request delay (CH1).	×	×	○	R



No.	Name	Description	Compatible CPU module			R/W
			FX5S	FX5UJ	FX5U/ FX5UC*1	
SD8865	Number of retries (CH1)	This register stores the number of retries during timeout (CH1).	×	×	○	R
SD8871, SD8881, SD8891	Host station number (CH2 to CH4)	These registers store the host station number (CH2 to CH4).	○	○	○	R/W
SD8872, SD8882, SD8892	Slave response timeout (CH2 to CH4)	These registers store the slave response timeout (CH2 to CH4).	○	○	○	R
SD8873, SD8883, SD8893	Turn around delay (CH2 to CH4)	These registers store the broadcast delay (CH2 to CH4).	○	○	○	R
SD8874, SD8884, SD8894	Message to message delay (CH2 to CH4)	These registers store the request to request delay (CH2 to CH4).	○	○	○	R
SD8875, SD8885, SD8895	Number of retries (CH2 to CH4)	These registers store the number of retries during timeout (CH2 to CH4).	○	○	○	R
SD8921	IVBWR instruction error parameter number (CH1)	This register stores the IVBWR instruction error parameter number (CH1).	×	×	○	R
SD8931, SD8941, SD8951	IVBWR instruction error parameter number (CH2 to CH4)	These registers store the IVBWR instruction error parameter numbers (CH2 to CH4).	○	○	○	R
SD8981	Response wait time (CH1)	This register stores the response wait time (CH1).	×	×	○	R
SD8991, SD9001, SD9011	Response wait time (CH2 to CH4)	These registers store the response wait time (CH2 to CH4).	○	○	○	R
SD9040	Station number	This register stores the station number.	○	○	○	R
SD9041	Total number of slave stations	This register stores the total number of slave stations.	○	○	○	R
SD9043	Current link scan time	This register stores the current link scan time.	○	○	○	R
SD9044	Maximum link scan time	This register stores the maximum link scan time.	○	○	○	R
SD9045	Number of communication error at master station	This register stores the number of communication error at master station.	○	○	○	R
SD9046 to SD9052	Number of communication error at slave station No.1 to No.7	These registers store the number of communication error at slave station No.1 to No.7.	○	○	○	R
SD9061	Code of communication error at master station	This register stores the code of communication error at master station.	○	○	○	R
SD9062 to SD9068	Code of communication error at slave station No.1 to No.7	These registers store the code of communication error at slave station No.1 to No.7.	○	○	○	R
SD9080	Station number setting	This register stores the station number setting.	○	○	○	R/W
SD9081	Total slave station number setting	This register stores the total slave station number setting.	○	○	○	R/W
SD9082	Refresh range setting	This register stores the refresh range setting.	○	○	○	R
SD9083	Retry count setting	This register stores the retry count setting.	○	○	○	R
SD9084	Communication time-out setting	This register stores the communication time-out setting.	○	○	○	R
SD9090	Master station/slave station setting	The master station/slave station settings are stored.	○	○	○	R
SD9091	Link mode setting	The link mode settings are stored.	○	○	○	R
SD9092	Error determination time setting	The error determination time setting is stored.	○	○	○	R
SD9102	Predefined protocol ready	The reflected status after the protocol setting data has been written is stored. 0: Faulty 1: Normal	○	○	○	R
SD9120	Predefined protocol setting data error information: Protocol No.	When a protocol setting data error was detected, information to identify the error position is stored. 0: Normal 1 to 64: Protocol No. 65535: Specification not allowed	○	○	○	R
SD9121	Predefined protocol setting data error information: Setting type	When a protocol setting data error was detected, information to identify the error position is stored. 0: Packet setting or element setting 1: Configuring detailed setting of protocols 65535: Specification not allowed	○	○	○	R



No.	Name	Description	Compatible CPU module			R/W
			FX5S	FX5UJ	FX5U/ FX5UC*1	
SD9122	Predefined protocol setting data error information: Packet No.	When a protocol setting data error was detected, information to identify the error position is stored. 0: Send packet 1 to 16: Receive packet 65535: Specification not allowed	○	○	○	R
SD9123	Predefined protocol setting data error information: Element No.	When a protocol setting data error was detected, information to identify the error position is stored. 1 to 32: Element No. 65535: Specification not allowed	○	○	○	R
SD9124	Number of registered predefined protocols	The number of registered protocol setting data is stored. 1 to 64	○	○	○	R
SD9132	Predefined protocol registration (1 to 16)	The ON/OFF state of the bit corresponding to a protocol number indicates whether the protocol setting data has been registered or not. b15 to b0: 16 to 1	○	○	○	R
SD9133	Predefined protocol registration (17 to 32)	The ON/OFF state of the bit corresponding to a protocol number indicates whether the protocol setting data has been registered or not. b15 to b0: 32 to 17	○	○	○	R
SD9134	Predefined protocol registration (33 to 48)	The ON/OFF state of the bit corresponding to a protocol number indicates whether the protocol setting data has been registered or not. b15 to b0: 48 to 33	○	○	○	R
SD9135	Predefined protocol registration (49 to 64)	The ON/OFF state of the bit corresponding to a protocol number indicates whether the protocol setting data has been registered or not. b15 to b0: 64 to 49	○	○	○	R
SD9150	Protocol execution status (CH1)	The status of a protocol in execution (CH1) is stored. 0: Unexecuted 1: Waiting for transmission 2: Sending 3: Waiting for data reception 4: Receiving 5: Execution completed	×	×	○	R
SD9168	Protocol execution count (CH1)	The cumulative number of executions (CH1) of a protocol is stored. 0 to 65535	×	×	○	R
SD9169	Protocol cancel specification (CH1)	The protocol (CH1) in execution can be cancelled with a value to be stored in this area. 0: Normal operation (do not cancel) 1: Cancel request 2: Cancel operation completed	×	×	○	R/W
SD9170, SD9190, SD9210	Protocol execution status (CH2 to CH4)	These registers store the status of a protocol in execution (CH2 to CH4). 0: Unexecuted 1: Waiting for transmission 2: Sending 3: Waiting for data reception 4: Receiving 5: Execution completed	○	○	○	R
SD9188, SD9208, SD9228	Protocol execution count (CH2 to CH4)	These registers store the cumulative number of executions (CH2 to CH4) of a protocol. 0 to 65535	○	○	○	R
SD9189, SD9209, SD9229	Protocol cancel specification (CH2 to CH4)	The protocol (CH2 to CH4) in execution can be canceled with a value to be stored in these areas. 0: Normal operation (do not cancel) 1: Cancel request 2: Cancel operation completed	○	○	○	R/W

No.	Name	Description	Compatible CPU module			R/W
			FX5S	FX5UJ	FX5U/ FX5UC*1	
SD9230	Send/receive data monitoring function setting (CH1)	The setting (CH1) of the send/receive data monitoring function is stored. 0000H: Monitor stop 0001H: Monitor start 0002H: Monitoring (set by system) 1002H: Monitor stop (set by system) 100FH: Monitor setting error (set by system)	×	×	○	R/W
SD9231	Send/receive data monitoring function option setting (CH1)	The option setting (CH1) of the send/receive data monitoring function is stored. b0: Data area full stop specification b1: Packet stop specification	×	×	○	W
SD9232	Monitoring data device specification (CH1)	The type of word device (CH1) used as the monitor data areas is stored. 0: D device 1: R device 2: W device 3: SW device	×	×	○	W
SD9233	Monitoring data start device No. specification (CH1)	The start device number (CH1) of word devices used as the monitor data areas is stored. 0 to 32765	×	×	○	W
SD9234	Monitoring data size specification (CH1)	The size (CH1) of word devices used as the monitor data areas is stored in word units. 1 to 32765	×	×	○	W
SD9240, SD9250, SD9260	Send/receive data monitoring function setting (CH2 to CH4)	The setting (CH2 to CH4) of the send/receive data monitoring function is stored. 0000H: Monitor stop 0001H: Monitor start 0002H: Monitoring (set by system) 1002H: Monitor stop (set by system) 100FH: Monitor setting error (set by system)	○	○	○	R/W
SD9241, SD9251, SD9261	Send/receive data monitoring function option setting (CH2 to CH4)	The option setting (CH2 to CH4) of the send/receive data monitoring function is stored. b0: Data area full stop specification b1: Packet stop specification	○	○	○	W
SD9242, SD9252, SD9262	Monitoring data device specification (CH2 to CH4)	The type of word device (CH2 to CH4) used as the monitor data areas is stored. 0: D device 1: R device 2: W device 3: SW device	○	○	○	W
SD9243, SD9253, SD9263	Monitoring data start device No. specification (CH2 to CH4)	The start device number (CH2 to CH4) of word devices used as the monitor data areas is stored. 0 to 32765	○	○	○	W
SD9244, SD9254, SD9264	Monitoring data size specification (CH2 to CH4)	The size (CH2 to CH4) of word devices used as the monitor data areas is stored in word units. 1 to 32765	○	○	○	W

\*1 CH2 devices for serial communication are not supported by FX5UC CPU module.

\*2 Varies according to the host station number SD latch setting state.

Latch disabled: R, Latch enabled: R/W

## Built-in Ethernet function

The special registers for built-in Ethernet are shown below.

No.	Name	Description	Compatible CPU module			R/W
			FX5S	FX5UJ	FX5U/ FX5UC	
SD10050	Local node IP address [Low-order]	This register stores the local node IP address.	○	○	○	R
SD10051	Local node IP address [High-order]					
SD10060	Subnet mask [Low-order]	This register stores the subnet mask.	○	○	○	R
SD10061	Subnet mask [High-order]					

No.	Name	Description	Compatible CPU module			R/W
			FX5S	FX5UJ	FX5U/ FX5UC	
SD10064	Default gateway IP address [Low-order]	This register stores the default gateway IP address.	○	○	○	R
SD10065	Default gateway IP address [High-order]					
SD10074	Local node MAC address	This register stores the local node MAC address (5 and 6 bytes).	○	○	○	R
SD10075	Local node MAC address	This register stores the local node MAC address (3 and 4 bytes).	○	○	○	R
SD10076	Local node MAC address	This register stores the local node MAC address (1 and 2 bytes).	○	○	○	R
SD10082	Communication speed setting	This register stores the communication speed setting.	○	○	○	R
SD10084	MELSOFT connection TCP port No.	This register stores the MELSOFT connection TCP port No.	○	○	○	R
SD10086	MELSOFT direct connection port No.	This register stores the MELSOFT direct connection port No.	○	○	○	R
SD10130 to SD10137	Connection No.1 to 8 latest error code	These registers store the connection No.1 to 8 latest error code.	○	○	○	R
SD10147	MELSOFT direct connection latest error code	This register stores the MELSOFT direct connection latest error code.	○	○	○	R
SD10251	Same IP address state storage area	b0: Same IP address detection flag 0: No same IP address 1: Same IP address	○	○	○	R
SD10252	MAC address of the already connected station	This register stores the MAC address (5 and 6 bytes) of the already connected station.	○	○	○	R
SD10253	MAC address of the already connected station	This register stores the MAC address (3 and 4 bytes) of the already connected station.	○	○	○	R
SD10254	MAC address of the already connected station	This register stores the MAC address (1 and 2 bytes) of the already connected station.	○	○	○	R
SD10255	MAC address of the station connected later	This register stores the MAC address (5 and 6 bytes) of the station connected later.	○	○	○	R
SD10256	MAC address of the station connected later	This register stores the MAC address (3 and 4 bytes) of the station connected later.	○	○	○	R
SD10257	MAC address of the station connected later	This register stores the MAC address (1 and 2 bytes) of the station connected later.	○	○	○	R
SD10270	Remote password lock status connection No.1 to 8	b0: Connection No.1 b1: Connection No.2 b2: Connection No.3 b3: Connection No.4 b4: Connection No.5 b5: Connection No.6 b6: Connection No.7 b7: Connection No.8 0: Unlock status/remote password setting none 1: Lock status	○	○	○	R
SD10271	Remote password lock status system port	b1: MELSOFT application communication port (UDP) b2: MELSOFT application communication port (TCP) b3: MELSOFT direct connection b4: FTP transmission port 0: Unlock status/remote password setting none 1: Lock status	○	○	○	R
SD10290	Time setting function operation result	Stores the operation result of the time setting function. 0000H: Unexecuted 0001H: Success FFFFH: Failure	○	○	○	R
SD10291	Time setting function execution time (Year)	The year (A.D.) which the time setting function is executed is stored in a binary code. When the communication fails, this device is not updated.	○	○	○	R



No.	Name	Description	Compatible CPU module			R/W
			FX5S	FX5UJ	FX5U/ FX5UC	
SD10292	Time setting function execution time (Month)	The month which the time setting function is executed is stored in a binary code. When the communication fails, this device is not updated.	○	○	○	R
SD10293	Time setting function execution time (Day)	The day which the time setting function is executed is stored in a binary code. When the communication fails, this device is not updated.	○	○	○	R
SD10294	Time setting function execution time (Hour)	The hour which the time setting function is executed is stored in a binary code. When the communication fails, this device is not updated.	○	○	○	R
SD10295	Time setting function execution time (Minute)	The minute which the time setting function is executed is stored in a binary code. When the communication fails, this device is not updated.	○	○	○	R
SD10296	Time setting function execution time (Second)	The second which the time setting function is executed is stored in a binary code. When the communication fails, this device is not updated.	○	○	○	R
SD10297	Time setting function execution time (Day of the week)	The day of the week which the time setting function is executed is stored in a binary code. 0: Sunday 1: Monday 2: Tuesday 3: Wednesday 4: Thursday 5: Friday 6: Saturday When the communication fails, this device is not updated.	○	○	○	R
SD10298	Time setting function required response time	A time required from sending the message to the SNTP server to receiving the response and setting the time to the CPU module is stored. Range: 0000H to FFFE H (Unit: ms) If the value exceeds the above range, all the values are stored as FFFFH. When the communication fails, this device is not updated.	○	○	○	R
SD10299	Time setting function execution	This turns ON when the time setting function is executed. This automatically turns OFF when the time setting is completed or time out occurs in communication. 0: No execution request 1: Execution requested	○	○	○	R/W
SD10320 to SD10327	Connections 1 to 8 continuous unlock failure number of times	These registers store the connections 1 to 8 continuous unlock failure number of times.	○	○	○	R
SD10337	MELSOFT communication port (UDP/IP) continuous unlock failure number of times	This register stores the MELSOFT communication port (UDP/IP) continuous unlock failure number of times.	○	○	○	R
SD10338	MELSOFT communication port (TCP/IP) continuous unlock failure number of times	This register stores the MELSOFT communication port (TCP/IP) continuous unlock failure number of times.	○	○	○	R
SD10339	FTP transmission port (TCP/IP) continuous unlock failure count	This register stores the FTP transmission port (TCP/IP) continuous unlock failure count.	○	○	○	R
SD10340	MELSOFT direct connection continuous unlock failure number of times	This register stores the MELSOFT direct connection continuous unlock failure number of times.	○	○	○	R

No.	Name	Description	Compatible CPU module			R/W
			FX5S	FX5UJ	FX5U/ FX5UC	
SD10350	Request to start communication	Request contact to start data communication when the communication setting for the simple CPU communication is "Request" [b0] to [b15]: Setting No.1 to Setting No.16 0 to 1: Requested (start request) To make start request again, first stop the request and then make start request.	○	○	○	R/W
SD10351		Request contact to start data communication when the communication setting for the simple CPU communication is "Request" [b0] to [b15]: Setting No.17 to Setting No.32 0 to 1: Requested (start request) To make start request again, first stop the request and then make start request.	×	×	○	R/W
SD10352	Request to stop communication	Request contact to stop data transmission when the communication setting for the simple CPU communication is "Fixed" [b0] to [b15]: Setting No.1 to Setting No.16 0 to 1: Requested (stop request) 1 to 0: Completed (stop completion)	○	○	○	R/W
SD10353		Request contact to stop data transmission when the communication setting for the simple CPU communication is "Fixed" [b0] to [b15]: Setting No.17 to Setting No.32 0 to 1: Requested (stop request) 1 to 0: Completed (stop completion)	×	×	○	R/W
SD10354	Request to restart communication	Request contact to restart data transmission when the communication setting for the simple CPU communication is "Fixed" [b0] to [b15]: Setting No.1 to Setting No.16 0 to 1: Requested (restart request) 1 to 0: Completed (restart completion)	○	○	○	R/W
SD10355		Request contact to restart data transmission when the communication setting for the simple CPU communication is "Fixed" [b0] to [b15]: Setting No.17 to Setting No.32 0 to 1: Requested (restart request) 1 to 0: Completed (restart completion)	×	×	○	R/W
SD10356	Execution status flag	The data transmission/reception status of the simple CPU communication is stored for each setting number. [b0] to [b15]: Setting No.1 to Setting No.16 0: Communication stop (function not used) 1: Communicating	○	○	○	R
SD10357		The data transmission/reception status of the simple CPU communication is stored for each setting number. [b0] to [b15]: Setting No.17 to Setting No.32 0: Communication stop (function not used) 1: Communicating	×	×	○	R
SD10358	Preparation completion flag	The preparation completion status of the simple CPU communication is stored for each setting number. [b0] to [b15]: Setting No.1 to Setting No.16 0: Not ready (function not used) 1: Ready	○	○	○	R
SD10359		The preparation completion status of the simple CPU communication is stored for each setting number. [b0] to [b15]: Setting No.17 to Setting No.32 0: Not ready (function not used) 1: Ready	×	×	○	R



No.	Name	Description	Compatible CPU module			R/W
			FX5S	FX5UJ	FX5U/ FX5UC	
SD10380 to SD10395	Simple CPU communication status	The simple CPU communication status is stored. SD10380: Setting No.1 to SD10395: Setting No.16 0H: Unset 1H: Preparing 3H: Communicating 4H: Communication stop 5H: Retry being executed 6H: Monitoring at error AH: Communications impossible	○	○	○	R
SD10396 to SD10411		The simple CPU communication status is stored. SD10396: Setting No.17 to SD10411: Setting No.32 0H: Unset 1H: Preparing 3H: Communicating 4H: Communication stop 5H: Retry being executed 6H: Monitoring at error AH: Communications impossible	×	×	○	R
SD10412 to SD10427	Simple CPU communication error code	The cause of the error detected in the simple CPU communication is stored. SD10412: Setting No.1 to SD10427: Setting No.16 0: No error (function not used) Other than 0: Error code The value is cleared to 0 with a clear request from the engineering tool.	○	○	○	R
SD10428 to SD10443		The cause of the error detected in the simple CPU communication is stored. SD10428: Setting No.17 to SD10443: Setting No.32 0: No error (function not used) Other than 0: Error code The value is cleared to 0 with a clear request from the engineering tool.	×	×	○	R
SD10444 to SD10459	Simple CPU communication execution interval (current value)	If "Fixed" is set for communication setting, the current value of the execution interval is stored. SD10444: Setting No.1 to SD10459: Setting No.16 0: Unset (function not used), communications impossible Other than 0: Execution interval (unit: ms)	○	○	○	R
SD10460 to SD10475		If "Fixed" is set for communication setting, the current value of the execution interval is stored. SD10460: Setting No.17 to SD10475: Setting No.32 0: Unset (function not used), communications impossible Other than 0: Execution interval (unit: ms)	×	×	○	R
SD10476 to SD10491	Error response code	The error response code detected by simple CPU communication is stored. SD10476: Setting No.1 to SD10491: Setting No.16	○	○	○	R
SD10492 to SD10507		The error response code detected by simple CPU communication is stored. SD10492: Setting No.17 to SD10507: Setting No.32	×	×	○	R

No.	Name	Description	Compatible CPU module			R/W
			FX5S	FX5UJ	FX5U/ FX5UC	
SD10680	Open completion signal	b0: Connection No.1 b1: Connection No.2 b2: Connection No.3 b3: Connection No.4 b4: Connection No.5 b5: Connection No.6 b6: Connection No.7 b7: Connection No.8 0: Close/Open not completed 1: Open completed	○	○	○	R
SD10681	Open request signal	b0: Connection No.1 b1: Connection No.2 b2: Connection No.3 b3: Connection No.4 b4: Connection No.5 b5: Connection No.6 b6: Connection No.7 b7: Connection No.8 0: No open request 1: Open request exists	○	○	○	R
SD10682	Socket communications receive status signal	b0: Connection No.1 b1: Connection No.2 b2: Connection No.3 b3: Connection No.4 b4: Connection No.5 b5: Connection No.6 b6: Connection No.7 b7: Connection No.8 0: No data received 1: Data receiving completed	○	○	○	R
SD10683	Initial status	b0: Initial normal completion status b1: Initialization abnormal completion 0: Not completed 1: Completed	○	○	○	R
SD10692	Predefined protocol ready	0: Not ready 1: Ready	○	○	○	R
SD10710	Predefined protocol setting data error information protocol number	When a protocol setting data error is detected, stores the protocol number where the error was detected.	○	○	○	R
SD10711	Predefined protocol setting data error information setting type	0 is stored if an error is detected in the packet setting or element setting. 1 is stored if an error is detected in the protocol detailed setting.	○	○	○	R
SD10712	Predefined protocol setting data error information packet number	When an error is detected in the protocol setting data, stores the packet number that detected the error.	○	○	○	R
SD10713	Predefined protocol setting data error information Element number	When an error is detected in the protocol setting data, stores the element number where the error was detected.	○	○	○	R
SD10714	Number of registered predefined protocols	Stores the protocol number of the registered protocol setting data.	○	○	○	R
SD10722	Predefined protocol registration (1 to 16)	Whether protocol setting data is registered or not is stored.	○	○	○	R
SD10723	Predefined protocol registration (17 to 32)					
SD10724	Predefined protocol registration (33 to 48)					
SD10725	Predefined protocol registration (49 to 64)					



No.	Name	Description	Compatible CPU module			R/W
			FX5S	FX5UJ	FX5U/ FX5UC	
SD10740	Connection No.1 protocol execution status	Stores the status of the protocol being executed at connection No.1. 0: Unexecuted 1: Waiting for transmission 2: Sending 3: Waiting for data reception 4: Receiving 5: Execution completed	○	○	○	R
SD10742 to SD10757	Connection No.1 received data verification result (receive packet No.1 to 16)	Stores the verification results of receive packet No.1 to 16. Element No. where the verification result did not match (b0 to b7) The cause of mismatch (verification result code) (b8 to b15)	○	○	○	R
SD10758	Connection No.1 protocol execution count	Stores the number of protocol executions in Connection No.1. 0: Protocol not executed 1 to 65535: Number of executions	○	○	○	R
SD10759	Connection No.1 protocol cancellation specification	Cancels the protocol executed in connection No.1. 0: No cancellation instruction 1: Cancel request 2: Cancellation completed	○	○	○	R/W
SD10760	Connection No.2 protocol execution status	Stores the status of the protocol being executed at connection No.2. 0: Unexecuted 1: Waiting for transmission 2: Sending 3: Waiting for data reception 4: Receiving 5: Execution completed	○	○	○	R
SD10762 to SD10777	Connection No.2 received data verification result (receive packet No.1 to 16)	Stores the verification results of receive packet No.1 to 16. Element No. where the verification result did not match (b0 to b7) The cause of mismatch (verification result code) (b8 to b15)	○	○	○	R
SD10778	Connection No.2 protocol execution count	Stores the number of protocol executions in connection No.2. 0: Protocol not executed 1 to 65535: Number of executions	○	○	○	R
SD10779	Connection No.2 protocol cancellation specification	Cancels the protocol executed in connection No.2. 0: No cancellation instruction 1: Cancel request 2: Cancellation completed	○	○	○	R/W
SD10780	Connection No.3 protocol execution status	Stores the status of the protocol being executed at connection No.3. 0: Unexecuted 1: Waiting for transmission 2: Sending 3: Waiting for data reception 4: Receiving 5: Execution completed	○	○	○	R
SD10782 to SD10797	Connection No.3 received data verification result (receive packet No.1 to 16)	Stores the verification results of receive packet No.1 to 16. Element No. where the verification result did not match (b0 to b7) The cause of mismatch (verification result code) (b8 to b15)	○	○	○	R
SD10798	Connection No.3 protocol execution count	Stores the number of protocol executions in connection No.3. 0: Protocol not executed 1 to 65535: Number of executions	○	○	○	R



No.	Name	Description	Compatible CPU module			R/W
			FX5S	FX5UJ	FX5U/ FX5UC	
SD10799	Connection No.3 protocol cancellation specification	Cancels the protocol executed in connection No.3. 0: No cancellation instruction 1: Cancel request 2: Cancellation completed	○	○	○	R/W
SD10800	Connection No.4 protocol execution status	Stores the status of the protocol being executed at connection No.4. 0: Unexecuted 1: Waiting for transmission 2: Sending 3: Waiting for data reception 4: Receiving 5: Execution completed	○	○	○	R
SD10802 to SD10817	Connection No.4 received data verification result (receive packet No.1 to 16)	Stores the verification results of receive packet No.1 to 16. Element No. where the verification result did not match (b0 to b7) The cause of mismatch (verification result code) (b8 to b15)	○	○	○	R
SD10818	Connection No.4 protocol execution count	Stores the number of protocol executions in connection No.4. 0: Protocol not executed 1 to 65535: Number of executions	○	○	○	R
SD10819	Connection No.4 protocol cancellation specification	Cancels the protocol executed in connection No.4. 0: No cancellation instruction 1: Cancel request 2: Cancellation completed	○	○	○	R/W
SD10820	Connection No.5 protocol execution status	Stores the status of the protocol being executed at connection No.5. 0: Unexecuted 1: Waiting for transmission 2: Sending 3: Waiting for data reception 4: Receiving 5: Execution completed	○	○	○	R
SD10822 to SD10837	Connection No.5 received data verification result (receive packet No.1 to 16)	Stores the verification results of receive packet No.1 to 16. Element No. where the verification result did not match (b0 to b7) The cause of mismatch (verification result code) (b8 to b15)	○	○	○	R
SD10838	Connection No.5 protocol execution count	Stores the number of protocol executions in connection No.5. 0: Protocol not executed 1 to 65535: Number of executions	○	○	○	R
SD10839	Connection No.5 protocol cancellation specification	Cancels the protocol executed in connection No.5. 0: No cancellation instruction 1: Cancel request 2: Cancellation completed	○	○	○	R/W
SD10840	Connection No.6 protocol execution status	Stores the status of the protocol being executed at connection No.6. 0: Unexecuted 1: Waiting for transmission 2: Sending 3: Waiting for data reception 4: Receiving 5: Execution completed	○	○	○	R
SD10842 to SD10857	Connection No.6 received data verification result (receive packet Nos.1 to 16)	Stores the verification results of receive packet No.1 to 16. Element No. where the verification result did not match (b0 to b7) The cause of mismatch (verification result code) (b8 to b15)	○	○	○	R



No.	Name	Description	Compatible CPU module			R/W
			FX5S	FX5UJ	FX5U/ FX5UC	
SD10858	Connection No.6 protocol execution count	Stores the number of protocol executions in connection No.6. 0: Protocol not executed 1 to 65535: Number of executions	○	○	○	R
SD10859	Connection No.6 protocol cancellation specification	Cancels the protocol executed in connection No.6. 0: No cancellation instruction 1: Cancel request 2: Cancellation completed	○	○	○	R/W
SD10860	Connection No.7 protocol execution status	Stores the status of the protocol being executed at connection No.7. 0: Unexecuted 1: Waiting for transmission 2: Sending 3: Waiting for data reception 4: Receiving 5: Execution completed	○	○	○	R
SD10862 to SD10877	Connection No.7 received data verification result (receive packet Nos.1 to 16)	Stores the verification results of receive packet No.1 to 16. Element No. where the verification result did not match (b0 to b7) The cause of mismatch (verification result code) (b8 to b15)	○	○	○	R
SD10878	Connection No.7 protocol execution count	Stores the number of protocol executions in connection No.7. 0: Protocol not executed 1 to 65535: Number of executions	○	○	○	R
SD10879	Connection No.7 protocol cancellation specification	Cancels the protocol executed in connection No.7. 0: No cancellation instruction 1: Cancel request 2: Cancellation completed	○	○	○	R/W
SD10880	Connection No.8 protocol execution status	Stores the status of the protocol being executed at connection No.8. 0: Unexecuted 1: Waiting for transmission 2: Sending 3: Waiting for data reception 4: Receiving 5: Execution completed	○	○	○	R
SD10882 to SD10897	Connection No.8 received data verification result (receive packet Nos.1 to 16)	Stores the verification results of receive packet No.1 to 16. Element No. where the verification result did not match (b0 to b7) The cause of mismatch (verification result code) (b8 to b15)	○	○	○	R
SD10898	Connection No.8 protocol execution count	Stores the number of protocol executions in connection No.8. 0: Protocol not executed 1 to 65535: Number of executions	○	○	○	R
SD10899	Connection No.8 protocol cancellation specification	Cancels the protocol executed in connection No.8. 0: No cancellation instruction 1: Cancel request 2: Cancellation completed	○	○	○	R/W

# Appendix 3 Error Code

The CPU module stores error code in special register (SD) upon detection of an error using the self-diagnostics function. The error details and cause can be identified by checking the error code. The error code can be checked in either of the following ways.

- Module diagnostics of the engineering tool (MELSEC iQ-F FX5S/FX5UJ/FX5U/FX5UC User's Manual (Hardware))

This section describes errors that may occur in the CPU module and actions to be taken for the errors.

## Error code system

All error codes are given in hexadecimal format (4 digits) (16-bit unsigned integer). The following table lists the error detection type and the error code ranges.

Error detection type		Range	Description
By the self-diagnostic function of each module	Minor error	1000H to 1FFFH	Error code specific to each module, such as self-diagnostics errors
	Moderate error	2000H to 3BFFH	
	Major error	3C00H to 3FFFH	
Detected during communication between CPU modules		4000H to 4FFFH	Error in the CPU module
		7000H to 7FFFH	MELSEC iQ-F FX5 User's Manual (Communication)
		8100H to 8230H	Error in PID control via parameter
		C000H to CFBFH	MELSEC iQ-F FX5 User's Manual (Communication)
		CFC0H to CFFFH	Error in CC-Link IE Field Network Basic
		D000H to DFFFH	MELSEC iQ-F FX5 CC-Link IE Field Network Module User's Manual

## Detailed information

Upon detection of error through self-diagnostics function, the detailed information of the error cause is stored all together. The following detailed information is added to each error code (up to two types of information are stored for each error code. The types differ depending on error code.) Detailed information 1 to 2 of the latest error code(s) can be checked with special register (SD).

Detailed information	Item	Description
Detailed information 1	Error location information <sup>*1</sup>	Information on the location in a program, such as step No. is indicated.
	Drive/file information	Information on drive names and file names
	Parameter information	The information for the parameter, such as parameter storage location and parameter type, is indicated.
	System configuration information	The information for the system configuration, such as I/O No. is indicated.
	Frequency information	This section describes the information for frequency such as the write frequency into memory.
	Time information	The information for the time is indicated.
Detailed information 2	Drive/file information	Information on drive names and file names
	Annunciator information	Information about annunciators
	Parameter information	The information for the parameter, such as parameter storage location and parameter type, is indicated.
	System configuration information	The information for the system configuration, such as I/O No. is indicated.

\*1 The step No., which is displayed in the program position information, is the step No. that is counted from the head of the file. It might be sometimes different from the step No. of the program which is displayed in error jump of engineering tool.



# Operation when an error occurs

There are two types of errors: continuation errors and stop errors.

## Stop error

If a stop error occurs, the CPU module stops its operation and the operating state will be in STOP. Modules can communicate with the CPU module even after a stop error occurs in the CPU module.

## Continuation error

If a continuation error occurs, the CPU module continues its operation. (The operating state will remain the same.)

# Error check

## Common error

When an error common to the functions other than the positioning function (operation error, parameter error) occurs, the following error flag turns on.

Latest self-diagnostic error (Including the annunciator ON)	Latest self-diagnostic error (Not including the annunciator ON)	Operation error	
SM0	SM1	SM56	SM8067

After the error flag above turns on, an error code is stored in the following device. One error code common to all the axes is stored.

Latest self diagnostics error code	Operation error
SD0	SD8067

When an operation error related to positioning occurs, one of the following error codes is stored.

Error code (HEX)	Description	Cause
1810	Operation error	Positioning of the axis specified is already in operation.
1811	Operation error	17 or more DABS instructions were driven simultaneously.
2221	Parameter error	The parameter set value is out of range or device specified by the parameter is out of range.
2801	Instruction execution error	The number of a module that does not exist is specified.
3055	System bus error	<ul style="list-style-type: none"> <li>All module reset was executed.</li> <li>A stop error occurred in the positioning of high-speed pulse input/output module.</li> </ul>
3056	System bus error	A bus error occurred and a response was not returned during bus access for high-speed pulse input/output module.
3057		
3060	System bus error	A signal error was detected at the time of bus access for high-speed pulse input/output module.
3061		
3405	Operation error	The operand of the instruction is out of range.
3582	Operation error	The positioning of high-speed pulse input/output module is executed in a user interruption program.
3600	Operation error	Positioning is attempted on an axis with no parameters specified. A function of the setting not used in parameters (such as interrupt input signal 1 or function related to origin return) is used.
36F0	ABS sum error	The ABS data sum from the servo amplifier does not match.

For details on error codes other than the above, refer to the following.

 Page 849 Error Code

## Positioning-dedicated error

When an error related to the positioning function occurs, the following special device turns on.

Name	CPU module				High-speed pulse input/output module							
					First module		Second module		Third module		Fourth module	
	Axis 1	Axis 2	Axis 3	Axis 4*1	Axis 5	Axis 6	Axis 7	Axis 8	Axis 9	Axis 10	Axis 11	Axis 12
Positioning error occurrence	SM5532	SM5533	SM5534	SM5535	SM5536	SM5537	SM5538	SM5539	SM5540	SM5541	SM5542	SM5543

After the device above turns on, an error code is stored in the corresponding special device below.

Name	CPU module				High-speed pulse input/output module							
					First module		Second module		Third module		Fourth module	
	Axis 1	Axis 2	Axis 3	Axis 4*1	Axis 5	Axis 6	Axis 7	Axis 8	Axis 9	Axis 10	Axis 11	Axis 12
Positioning error (error code)	SD5510	SD5550	SD5590	SD5630	SD5670	SD5710	SD5750	SD5790	SD5830	SD5870	SD5910	SD5950

\*1 Only FX5S/FX5U/FX5UC CPU module is supported.

The following error codes are stored in the positioning error (error code). Error codes of axis 4 are available only for the FX5S/FX5U/FX5UC CPU module.

## How to clear errors

Continuation errors can be cleared. (☞ Page 129 Error clear)

## List of error codes

### Self-diagnostics error codes of the CPU module (1000H to 3FFFH)

The following table lists the error codes detected by the self-diagnostics function of the CPU module.

Error code	Error name	Error details and cause	Stop/continue	Action	Detailed information	Diagnostic timing
1080H	ROM write count error	<ul style="list-style-type: none"> <li>The number of writes to the data memory exceeded 20,000 times.</li> </ul>	Continue	<ul style="list-style-type: none"> <li>Replace the CPU module.</li> </ul>	Frequency information	At write
1090H	Battery error	<ul style="list-style-type: none"> <li>Low battery voltage was detected. Or an error was detected in a battery keeping device.</li> </ul>	Continue	<ul style="list-style-type: none"> <li>Check the connection of the battery.</li> <li>Replace the battery as soon as possible.</li> </ul>	—	At END instruction execution
1100H	Memory card access error	<ul style="list-style-type: none"> <li>Writing failed because the write protect switch of the memory card is enabled (writing is prohibited).</li> <li>An SD memory card was inserted when the SD memory card access control switch was set to OFF (upward).</li> </ul>	Continue	<ul style="list-style-type: none"> <li>Disable the write protect switch of the memory card.</li> <li>Set the SD memory card access control switch to ON (downward) and insert an SD memory card.</li> </ul>	—	At write
1120H	SNTP time setting error	<ul style="list-style-type: none"> <li>Clock setting has failed when the system is powered on or the CPU module is reset.</li> <li>Clock setting using the time setting function (SNTP client) has failed.</li> </ul>	Continue	<ul style="list-style-type: none"> <li>Check if the time settings are correctly set in parameter.</li> <li>Check if the specified SNTP server is operating normally and there is no failure on the network accessing the SNTP server computer.</li> </ul>	—	At power-on, at RESET
112EH	Connection establishment failed	<ul style="list-style-type: none"> <li>The connection was not established during the open process.</li> </ul>	Continue	<ul style="list-style-type: none"> <li>Check the operation of the external device.</li> <li>Use an external device to confirm whether the open process was executed.</li> <li>Review the port No. of the module with Ethernet, the IP address/port No. of the external device, and the opening method.</li> <li>If the external device has a firewall set, check whether access is permitted.</li> <li>Check whether the Ethernet cable is disconnected.</li> </ul>	—	At END instruction execution

A

Error code	Error name	Error details and cause	Stop/continue	Action	Detailed information	Diagnostic timing
1134H	TCP connection timeout	• A TCP ULTP timeout error has occurred in the TCP/IP communication. (The external device does not send an ACK response.)	Continue	<ul style="list-style-type: none"> <li>• Check the operation of the external device.</li> <li>• Review the TCP ULTP timeout value for the module with Ethernet.</li> <li>• Since there may be congestion of packets on the line, send data after a certain period of time.</li> <li>• Check if the connection cable is disconnected.</li> </ul>	—	Always
1200H	Module moderate error detected	• Detected a notice of moderate error occurrence from intelligent function module.	Continue/stop <sup>*1</sup>	• Confirm detailed information (system configuration information) from module diagnosis of the engineering tool and remove the error of the abnormal module.	System configuration information	At END instruction execution
1800H	Annunciator ON	• An annunciator that was turned ON by the SET F instruction or OUT F instruction was detected.	Continue	• Check the program of that number (annunciator number).	Error location information and annunciator information	At instruction execution
1810H	Operation error	• The channel specified by instructions using communication functions or high-speed I/O is already used by other instructions.	Continue/stop <sup>*1</sup>	• Verify that the channel specified by instructions using communication functions or high-speed I/O is not used by other instructions.	Error location information	At instruction execution
1811H	Operation error	• The number of times that applied instructions are used in the program exceeded the specified limit.	Continue/stop <sup>*1</sup>	• Verify that the number of times that applied instructions are used in the program does not exceed the specified limit.	Error location information	At instruction execution
1821H to 182CH	Write during RUN error (axes 1 to 12)	• Writing during RUN (change or deletion) is performed on an instruction being executed.	Continue	<ul style="list-style-type: none"> <li>• Verify that the writing during RUN (change or deletion) is performed on an instruction being executed.</li> <li>• If the writing is executed during an ongoing RUN, after confirming that the pulse output is not occurring, turn OFF → ON the driving contact point to start the operation of the positioning instruction.</li> </ul>	Error location information and system configuration information	At END instruction execution
1900H	Constant scan time error	• The scan time exceeded the constant scan setting value.	Continue	• Check and correct the constant scan time setting.	Time information	At END instruction execution
1910H	Update error	• The file for updating is not found.	Continue	• Check the update setting.	Drive/file information	At power-on, at RESET
1911H	Update error	• The module to be updated is not connected to a correct position.	Continue	• Check the update setting and the connection of the module to be updated.	Drive/file information	At power-on, at RESET
1912H	Update error	• Recovery of the project data saved in the SD memory card failed.	Continue	• Recovery of the project data failed, so initialize all data, and then write in the set of project data backed up by the customer.	Drive/file information	At power-on, at RESET
1920H	IP address setting error	• Values such as the IP address setting (SD8492 to SD8497) are outside the set range.	Continue	• Recheck the values such as the IP address setting (SD8492 to SD8497).	—	At END instruction execution
1921H	IP address writing/clear request simultaneous detection	• Write request and clear request (SM8492 and SM8495) turned from OFF to ON simultaneously.	Continue	• Verify that write request and clear request (SM8492 and SM8495) do not turn from OFF to ON simultaneously.	—	At END instruction execution
1930H to 1932H	Online change error	• An error was detected when writing was executed during RUN.	Continue	• Set the CPU module to STOP and write a set of project data.	—	At END instruction execution
1FE0H	Module configuration error	• The number of I/O points specified in the I/O assignment setting of the parameters is different from that of the module connected.	Continue/stop <sup>*1</sup>	• Make sure that the parameters are consistent with the connections.	System configuration information	At power-on, at RESET

Error code	Error name	Error details and cause	Stop/continue	Action	Detailed information	Diagnostic timing
1FE1H	Module configuration error	<ul style="list-style-type: none"> <li>The module position specified in the I/O assignment setting of the parameters is different from that of the module connected.</li> </ul>	Continue/stop <sup>*1</sup>	<ul style="list-style-type: none"> <li>Make sure that the parameters are consistent with the connections.</li> </ul>	System configuration information	At power-on, at RESET
1FE2H	Module configuration error	<ul style="list-style-type: none"> <li>No parameters available for the module connected exist.</li> </ul>	Continue/stop <sup>*1</sup>	<ul style="list-style-type: none"> <li>Make sure that the parameters are consistent with the connections.</li> </ul>	System configuration information	At power-on, at RESET
1FE3H	Module configuration error	<ul style="list-style-type: none"> <li>The module specified in the I/O assignment setting of the parameters is not connected.</li> </ul>	Continue/stop <sup>*1</sup>	<ul style="list-style-type: none"> <li>Make sure that the parameters are consistent with the connections.</li> </ul>	System configuration information	At power-on, at RESET
1FE4H	Module configuration error	<ul style="list-style-type: none"> <li>Parameters for a standard input/output module are set to a high-speed pulse input/output module.</li> </ul>	Continue/stop <sup>*1</sup>	<ul style="list-style-type: none"> <li>Make sure that the parameters are consistent with the connections.</li> </ul>	System configuration information	At power-on, at RESET
1FE5H	Module configuration error	<ul style="list-style-type: none"> <li>The I/O numbers of the reserved module specified in the I/O assignment setting of the parameters overlap those of other modules.</li> </ul>	Continue/stop <sup>*1</sup>	<ul style="list-style-type: none"> <li>Make sure that the parameters are consistent with the connections.</li> </ul>	System configuration information	At power-on, at RESET
1FE6H	Module configuration error	<ul style="list-style-type: none"> <li>The I/O method of the input/output module is different.</li> </ul>	Continue/stop <sup>*1</sup>	<ul style="list-style-type: none"> <li>Make sure that the parameters are consistent with the connections.</li> </ul>	System configuration information	At power-on, at RESET
1FE7H	Module configuration error	<ul style="list-style-type: none"> <li>The type of the CPU module is different.</li> </ul>	Continue/stop <sup>*1</sup>	<ul style="list-style-type: none"> <li>Make sure that the parameters are consistent with the connections.</li> </ul>	System configuration information	At power-on, at RESET
1FE8H	Module configuration error	<ul style="list-style-type: none"> <li>The remote I/O points required by the system is insufficient.</li> </ul>	Continue	<ul style="list-style-type: none"> <li>Set the number of I/O points again within the maximum number of points for the entire system.</li> <li>The maximum number of points differs depending on the firmware version. Confirm the firmware version and update it if necessary.</li> </ul>	System configuration information	At power-on, at RESET
2003H	Module configuration error	<ul style="list-style-type: none"> <li>The model of the module connected is different from that of the module set in the parameters.</li> </ul>	Stop	<ul style="list-style-type: none"> <li>Make sure the model of the module to be set is consistent with the parameters of the module connected.</li> </ul>	System configuration information	At power-on, at RESET
2008H	Module configuration error	<ul style="list-style-type: none"> <li>The total number of I/O points (excluding remote I/O) exceeded the maximum points.</li> </ul>	Continue	<ul style="list-style-type: none"> <li>Do not use more than the maximum I/O points in programs.</li> <li>If writing failed, restart or reset the CPU module and then perform write during STOP status.</li> </ul>	System configuration information	At power-on, at RESET

Error code	Error name	Error details and cause	Stop/continue	Action	Detailed information	Diagnostic timing
2042H	CPU module configuration error	<ul style="list-style-type: none"> <li>■FX5S CPU module</li> <li>• The number of communication adapters connected is equal to or greater than 3.</li> <li>• The number of analog adapters connected is equal to or greater than 5.</li> <li>• The number of expansion boards connected is equal to or greater than 2.</li> <li>• With a communication board, the number of communication adapters connected is equal to or greater than 2.</li> <li>■FX5UJ CPU module</li> <li>• The number of input, output, input/output, and intelligent function modules connected is equal to or greater than 9.</li> <li>• The number of simple motion modules connected is equal to or greater than 2.</li> <li>• The number of communication adapters connected is equal to or greater than 3.</li> <li>• The number of analog adapters connected is equal to or greater than 3.</li> <li>• The number of extension power supply modules connected is equal to or greater than 2.</li> <li>• The number of expansion boards connected is equal to or greater than 2.</li> <li>• The number of intelligent function modules connected exceeds the limit of available connection.</li> <li>• With a communication board, the number of communication adapters connected is equal to or greater than 2.</li> <li>■FX5U/FX5UC CPU module</li> <li>• The number of input, output, input/output, and intelligent function modules connected is equal to or greater than 17.</li> <li>• The number of communication adapters connected is equal to or greater than 3.</li> <li>• The number of analog adapters connected is equal to or greater than 5.</li> <li>• The number of extension power supply modules connected is equal to or greater than 3.</li> <li>• The number of expansion boards connected is equal to or greater than 2.</li> <li>• The number of intelligent function modules connected exceeds the limit of available connection.</li> </ul>	Stop	<ul style="list-style-type: none"> <li>■FX5S CPU module</li> <li>• Use up to 2 communication adapters.</li> <li>• Use up to 4 analog adapters.</li> <li>• Use up to 1 expansion board.</li> <li>• When a communication board and a communication adapter are combined, the allowable number of communication adapters is 1 or less.</li> <li>■FX5UJ CPU module</li> <li>• Use up to 8 input, output, input/output, and intelligent function modules.</li> <li>• Use up to 1 simple motion modules.</li> <li>• Use up to 2 communication adapters.</li> <li>• Use up to 2 analog adapters.</li> <li>• Use up to 1 extension power supply module.</li> <li>• Use up to 1 expansion board.</li> <li>• Connect each intelligent function modules within the connectable limit.</li> <li>• When a communication board and a communication adapter are combined, the allowable number of communication adapters is 1 or less.</li> <li>■FX5U/FX5UC CPU module</li> <li>• Use up to 16 input, output, input/output, and intelligent function modules.</li> <li>• Use up to 2 communication adapters.</li> <li>• Use up to 4 analog adapters.</li> <li>• Use up to 2 extension power supply modules.</li> <li>• Use up to 1 expansion board.</li> <li>• Connect each intelligent function modules within the connectable limit.</li> </ul>	System configuration information	At power-on, at RESET



Error code	Error name	Error details and cause	Stop/continue	Action	Detailed information	Diagnostic timing
20E0H	Invalid module detection	<ul style="list-style-type: none"> <li>An unsupported module was detected.</li> </ul>	Stop	<ul style="list-style-type: none"> <li>Verify that the firmware version of the CPU module is compatible with the module where the error was detected.</li> <li>If the firmware version of the CPU module is correct, there may be a malfunction in the connected module. Replace the connected module.</li> </ul>	System configuration information	At power-on, at RESET
2120H	Memory card error	<ul style="list-style-type: none"> <li>An SD memory card error was detected.</li> <li>The SD memory card may have been removed without the SD memory card disabled.</li> </ul>	Continue/stop**13	<ul style="list-style-type: none"> <li>Check the connection of the SD memory card. If the problem persists, there may be a malfunction in the SD memory card or CPU module.</li> </ul>	Drive/file information	Always
2121H	Memory card error	<ul style="list-style-type: none"> <li>An SD memory card error was detected.</li> <li>The SD memory card may not be correctly formatted.</li> </ul>	Continue/stop**13	<ul style="list-style-type: none"> <li>Format the SD memory card. If the problem persists, there may be a malfunction in the SD memory card or CPU module.</li> </ul>	Drive/file information	Always
2160H	IP address duplication error	<ul style="list-style-type: none"> <li>The IP address is duplicated within the system.</li> </ul>	Continue	<ul style="list-style-type: none"> <li>Review the setting so that the IP address is not duplicated within the system.</li> </ul>	—	Always
2180H	Invalid file detection	<ul style="list-style-type: none"> <li>An error was found in the data of the file.</li> </ul>	Stop	<ul style="list-style-type: none"> <li>Recreate the file.</li> </ul>	Drive/file information	At power-on, at RESET, at STOP → RUN state
21A0H	File specification error	<ul style="list-style-type: none"> <li>The booted CPU module and the booting CPU module are not of the same model.</li> <li>The file specified in the parameters does not exist.</li> </ul>	Stop	<ul style="list-style-type: none"> <li>Boot the CPU module from a CPU module of the same model.</li> <li>Rewrite the project. If the same error appears, the hardware of the CPU module may be malfunctioning. Initialize the memory, and if the memory still cannot be recovered, consult your local Mitsubishi Electric representative.</li> </ul>	Drive/file information Parameter information	At power-on, at RESET, at STOP → RUN state
21A1H	File specification error	<ul style="list-style-type: none"> <li>The file specified in parameter cannot be created.</li> </ul>	Stop	<ul style="list-style-type: none"> <li>Check the detailed information (parameter information) of the error by executing module diagnostics using the engineering tool, and correct the name and size of the file corresponding to the displayed parameter number.</li> <li>Check the detailed information (drive/file information) of the error by executing module diagnostics using the engineering tool, and take the following actions:               <ol style="list-style-type: none"> <li>Format the corresponding drive.</li> <li>Delete unnecessary files on the corresponding drive to increase free space.</li> <li>Unlock the corresponding drive if it is locked.</li> </ol> </li> </ul>	Drive/file information	At power-on, at RESET
2200H	Parameter error	<ul style="list-style-type: none"> <li>The parameter file is not found.</li> </ul>	Stop	<ul style="list-style-type: none"> <li>Rewrite the project.</li> </ul>	Parameter information	At power-on, at RESET
2220H	Parameter error	<ul style="list-style-type: none"> <li>The contents of the parameters are corrupted.</li> </ul>	Stop	<ul style="list-style-type: none"> <li>Rewrite the project.</li> </ul>	Parameter information	At power-on, at RESET
2221H	Parameter error	<ul style="list-style-type: none"> <li>The parameter set value is out of range.</li> <li>A setting has been made to use a function that is not supported.</li> </ul>	Stop	<ul style="list-style-type: none"> <li>Modify the parameter set value and rewrite the project.</li> <li>The number of I/O points and supported modules and functions vary depending on the firmware version. Check the firmware version and update it as necessary.</li> </ul>	Parameter information	At power-on, at RESET
2222H	Parameter error	<ul style="list-style-type: none"> <li>The parameter set value is out of range.</li> <li>A setting has been made to use a function not supported by the target module.</li> </ul>	Stop	<ul style="list-style-type: none"> <li>Modify the parameter set value and rewrite the project.</li> <li>The number of I/O points and supported modules and functions vary depending on the firmware version. Check the firmware version and update it as necessary.</li> </ul>	Parameter information	At power-on, at RESET



Error code	Error name	Error details and cause	Stop/continue	Action	Detailed information	Diagnostic timing
2226H	Parameter error	<ul style="list-style-type: none"> <li>The SFC settings in the CPU parameter is incorrect. (Block 0 was set to start automatically, however, block 0 does not exist.)</li> </ul>	Stop	<ul style="list-style-type: none"> <li>Check the detailed information (parameter information) in the module diagnosis of the engineering tool, and review the parameter setting corresponding to the numerical value (parameter No.).</li> </ul>	Parameter information	At power-on, at RESET, at STOP → RUN state, at SFC program execution
2227H	Parameter error	<ul style="list-style-type: none"> <li>The execution type of the SFC program set in the CPU parameter program settings is other than the scan execution type.</li> </ul>	Stop	<ul style="list-style-type: none"> <li>Check the detailed information (parameter information) in the module diagnosis of the engineering tool, and review the parameter setting corresponding to the numerical value (parameter No.).</li> </ul>	Parameter information	At power-on, at RESET
2241H	Parameter error (module)	<ul style="list-style-type: none"> <li>The module parameter settings and the target module are different.</li> </ul>	Stop	<ul style="list-style-type: none"> <li>Modify the module parameter set value and rewrite the project.</li> </ul>	Parameter information	At power-on, at RESET
2250H	Parameter error (module)	<ul style="list-style-type: none"> <li>The module extension parameter for another module is written in the CPU module.</li> </ul>	Stop	<ul style="list-style-type: none"> <li>Write the protocol setting data for the target module into the CPU module.</li> </ul>	Parameter information	At power-on, at RESET
2260H	Network parameter error	<ul style="list-style-type: none"> <li>Network No. is duplicated.</li> </ul>	Stop	<ul style="list-style-type: none"> <li>Check the detailed information (parameter information) in the module diagnosis of the engineering tool, and review the parameter setting corresponding to the numerical value (parameter No.). If the same error is displayed again, there may be a hardware error in the data memory of the CPU module or the intelligent function module. Please contact your local Mitsubishi Electric representative.</li> </ul>	Parameter information	At power-on, at RESET
2280H	Parameter error (refresh)	<ul style="list-style-type: none"> <li>The refresh setting is set exceeding the device capacity. (Data were refreshed exceeding the file register capacity.)</li> </ul>	Stop	<ul style="list-style-type: none"> <li>Check the detailed information (parameter information) of the error by executing module diagnosis using the engineering tool, correct the parameter setting corresponding to the displayed value (parameter No.) and set the refresh range within the device setting range. (Take the following actions: increase the number of file register points (capacity) or reduce the refresh device range.)</li> <li>Rewrite the refresh settings (number of points) of the CPU parameter.</li> </ul>	Parameter information	At power-on, at RESET, at STOP → RUN state, at END instruction execution, at instruction execution, at module access
2281H	Parameter error (refresh)	<ul style="list-style-type: none"> <li>A device that cannot be used as a refresh device is specified.</li> </ul>	Stop	<ul style="list-style-type: none"> <li>Check the detailed information (parameter information) in the module diagnosis of the engineering tool, and review the parameter setting corresponding to the numerical value (parameter No.).</li> </ul>	Parameter information	At power-on, at RESET, at STOP → RUN state
2282H	Parameter error (refresh)	<ul style="list-style-type: none"> <li>The number of specified refresh points is invalid.</li> </ul>	Stop	<ul style="list-style-type: none"> <li>Check the detailed information (parameter information) in the module diagnosis of the engineering tool, and review the parameter setting corresponding to the numerical value (parameter No.).</li> </ul>	Parameter information	At power-on, at RESET, at STOP → RUN state
2283H	Parameter error (refresh)	<ul style="list-style-type: none"> <li>The total number of refresh points exceeded the maximum limit.</li> </ul>	Stop	<ul style="list-style-type: none"> <li>Check the detailed information (parameter information) in the module diagnosis of the engineering tool, and review the parameter setting corresponding to the numerical value (parameter No.).</li> </ul>	Parameter information	At power-on, at RESET, at STOP → RUN state
2300H	Security key authentication error	<ul style="list-style-type: none"> <li>The security key locking the program does not match the security key written in the CPU module.</li> </ul>	Stop	<ul style="list-style-type: none"> <li>Write the correct security key to the CPU module.</li> </ul>	Drive/file information	At power-on, at RESET, at STOP → RUN state
2301H	Security key authentication error	<ul style="list-style-type: none"> <li>The program is locked by the security key, but the security key is not written in the CPU module.</li> </ul>	Stop	<ul style="list-style-type: none"> <li>Write the security key to the CPU module.</li> </ul>	Drive/file information	At power-on, at RESET, at STOP → RUN state
2302H	Security key authentication error	<ul style="list-style-type: none"> <li>The security key written in the CPU module is corrupted.</li> </ul>	Stop	<ul style="list-style-type: none"> <li>Rewrite the security key to the CPU module.</li> </ul>	—	At power-on, at RESET, at STOP → RUN state

Error code	Error name	Error details and cause	Stop/continue	Action	Detailed information	Diagnostic timing
2320H	Remote password setting error	<ul style="list-style-type: none"> <li>A module supporting remote passwords is not connected to the module number specified in the remote password parameter.</li> </ul>	Stop	<ul style="list-style-type: none"> <li>Recheck the remote password parameter setting or module configuration.</li> </ul>	System configuration information	At power-on, at RESET
2400H	Module verification error	<ul style="list-style-type: none"> <li>The power of a connected module is OFF or a connection error has been detected.</li> <li>A timeout occurred during internal bus communications.</li> </ul>	Stop/continue <sup>*2</sup>	<ul style="list-style-type: none"> <li>Verify that the connected module is powered on.</li> <li>Verify that extension cables are correctly connected.</li> <li>Implement anti-noise measures.</li> <li>If there is no problem, there may be a malfunction in the connected module or in the extension cables. Replace the connected module.</li> </ul>	System configuration information	Always
2401H	Module verification error	<ul style="list-style-type: none"> <li>A module was connected during operation.</li> </ul>	Stop/continue <sup>*2</sup>	<ul style="list-style-type: none"> <li>Avoid connecting a module during operation.</li> </ul>	System configuration information	Always
2440H	Module major error	<ul style="list-style-type: none"> <li>The communication procedure with a module failed during initial processing.</li> </ul>	Stop	<ul style="list-style-type: none"> <li>Verify that extension cables are correctly connected.</li> <li>Verify that the firmware version of the CPU module is compatible with the module where the error was detected.</li> <li>If the version of the CPU module is correct, there may be a malfunction in the connected module. Replace the connected module.</li> </ul>	System configuration information	At power-on, at RESET
2441H	Module major error	<ul style="list-style-type: none"> <li>The communication procedure with a module failed when an instruction was executed.</li> </ul>	Continue/stop <sup>*1</sup>	<ul style="list-style-type: none"> <li>Review the program and check the contents of the operands used in the applied instructions.</li> <li>Verify that the specified buffer memory exists in the counterpart equipment.</li> <li>Verify that extension cables are correctly connected.</li> </ul>	Error location information and system configuration information	At instruction execution
2442H	Module major error	<ul style="list-style-type: none"> <li>An error has been detected in the I/O module or intelligent function module during the END processing.</li> </ul>	Continue/stop <sup>*1</sup>	<ul style="list-style-type: none"> <li>Refer to the manuals for the modules, and check the restrictions on the number of connected modules and the number of input/output points.</li> <li>There may be a hardware error in the faulty module. Consult your local Mitsubishi Electric representative.</li> </ul>	System configuration information	At module access
2450H	Module major error detected	<ul style="list-style-type: none"> <li>Detected a notice of major error occurrence from intelligent function module.</li> </ul>	Stop/continue <sup>*2</sup>	<ul style="list-style-type: none"> <li>Take measures against noise.</li> <li>Verify that extension cables are correctly connected.</li> <li>Confirm detailed information (system configuration information) in module diagnosis of engineering tool, and please check module corresponding to the numerical value (module No.). In addition, please confirm the details with reference to the manual of target module.</li> <li>After resetting the CPU unit, please execute RUN. If the same error is displayed again, there might be hardware failure of the module which became abnormal. Please contact the nearest Mitsubishi Electric system service Co., Ltd. or our branch office, agency.</li> </ul>	System configuration information	At END instruction execution
2463H	Intelligent module major error	<ul style="list-style-type: none"> <li>An error has been detected in intelligent function module.</li> </ul>	Stop	<ul style="list-style-type: none"> <li>Reset the CPU module, and run it again. If the same error code is displayed again, the possible cause is a hardware failure of the CPU module or intelligent function module where the error has been detected. Consult with your local Mitsubishi Electric representative.</li> </ul>	System configuration information	At power-on, at RESET

Error code	Error name	Error details and cause	Stop/continue	Action	Detailed information	Diagnostic timing
2500H	WDT error	<ul style="list-style-type: none"> <li>The initial scan time exceeded the set value of execution monitor time.</li> <li>The execution time of a fixed-cycle interrupt program exceeds the interrupt execution interval.</li> </ul>	Stop	<ul style="list-style-type: none"> <li>Recheck the set value of execution monitor time or program.</li> </ul>	Time information	Always
2501H	WDT error	<ul style="list-style-type: none"> <li>The scan time of the second and subsequent scans exceeded the set value of execution monitor time.</li> <li>The execution time of a fixed-cycle interrupt program exceeds the interrupt execution interval.</li> </ul>	Stop	<ul style="list-style-type: none"> <li>Recheck the set value of execution monitor time or program.</li> </ul>	Time information	Always
2522H	Invalid interrupt	<ul style="list-style-type: none"> <li>An interrupt request was detected from a module that does not have an interrupt pointer specified in the parameters.</li> </ul>	Continue	<ul style="list-style-type: none"> <li>Correctly set the interrupt pointer for module interrupt.</li> </ul>	System configuration information	At interrupt occurrence
2800H	Module specification error	<ul style="list-style-type: none"> <li>The specified module number is out of range.</li> </ul>	Continue/stop <sup>*1</sup>	<ul style="list-style-type: none"> <li>Check the detailed information (error location information) of the error by executing module diagnostics using the engineering tool, display the error program (step) by clicking the [Error Jump] button, and correct the program.</li> </ul>	Error location information	At instruction execution
2801H	Module specification error	<ul style="list-style-type: none"> <li>The module with the specified module number does not exist.</li> <li>There are incorrect devices used as an instruction operand.</li> </ul>	Continue/stop <sup>*1</sup>	<ul style="list-style-type: none"> <li>Specify the correct module number.</li> <li>Check the range of devices used by each operand and modify the program.</li> </ul>	Error location information and system configuration information	At instruction execution
2802H	Module specification error	<ul style="list-style-type: none"> <li>The I/O number of the module that does not support the instruction was specified.</li> <li>The dedicated instruction specified in the program cannot be executed in the specified module or mode.</li> </ul>	Continue/stop <sup>*1</sup>	<ul style="list-style-type: none"> <li>Check the detailed information (error location information) of the error by executing module diagnostics using the engineering tool, display the error program (step) by clicking the [Error Jump] button, and correct the program.</li> <li>Check the execution conditions (including support status and execution mode) of the dedicated instruction, referring to the manual for the target module.</li> </ul>	Error location information	At instruction execution
2820H	Device specification error	<ul style="list-style-type: none"> <li>A device used as an instruction operand is outside the allowable device range.</li> </ul>	Continue	<ul style="list-style-type: none"> <li>Check the device range and modify the program.</li> </ul>	Error location information	At power-on, at RESET, at instruction execution
2821H	Device specification error	<ul style="list-style-type: none"> <li>There are incorrect devices used as an instruction operand.</li> </ul>	Continue	<ul style="list-style-type: none"> <li>Check the range of devices used by each operand and modify the program.</li> </ul>	Error location information	At instruction execution
2822H	Device specification error	<ul style="list-style-type: none"> <li>A device or modification that cannot be used as an instruction operand is used.</li> <li>The step relay (S) is used as the operand of an instruction other than the SFC control instruction when the SFC program setting of the CPU parameter is set to "Use".</li> </ul>	Stop	<ul style="list-style-type: none"> <li>Check the usage of the instruction and modify the program.</li> <li>Change the step relay (S) used for the instruction to another device. (When the SFC program setting is set to "Use", the step relay (S) cannot be used for commands other than SFC control instructions.)</li> </ul>	Error location information	At power-on, at RESET
2823H	Device specification error	<ul style="list-style-type: none"> <li>The buffer memory area of the module specified in the instruction has exceeded the specified range. Or the module specified in the instruction does not have buffer memory.</li> </ul>	Continue	<ul style="list-style-type: none"> <li>Review the program or check the contents of the operands used in applied instructions.</li> <li>Verify that the specified buffer memory exists in the counterpart equipment.</li> </ul>	Error location information	At instruction execution

Error code	Error name	Error details and cause	Stop/continue	Action	Detailed information	Diagnostic timing
2840H	File name specification error	<ul style="list-style-type: none"> <li>The program file specified does not exist.</li> </ul>	Stop	<ul style="list-style-type: none"> <li>Rewrite the project.</li> </ul>	Error location information	At power-on, at RESET
3000H	Boot function execution error	<ul style="list-style-type: none"> <li>An error was found in the boot file.</li> </ul>	Stop	<ul style="list-style-type: none"> <li>Replace the boot file in the SD memory card with the correct file and turn the PLC power ON again.</li> </ul>	Drive/file information	At power-on, at RESET
3001H	Boot function execution error	<ul style="list-style-type: none"> <li>When the boot function was executed, the file format processing failed.</li> </ul>	Stop	<ul style="list-style-type: none"> <li>Reset the CPU module, and then execute the boot function again. If the same error appears, the hardware of the CPU module may be malfunctioning. Consult your local Mitsubishi Electric representative.</li> </ul>	Drive/file information	At power-on, at RESET
3003H	Boot function execution error	<ul style="list-style-type: none"> <li>When the boot function was executed, the file passwords did not match.</li> </ul>	Stop	<ul style="list-style-type: none"> <li>Check and correct the file password settings of the transfer source and transfer destination files.</li> <li>Delete the boot setting.</li> </ul>	Drive/file information	At power-on, at RESET
3004H	Boot function execution error	<ul style="list-style-type: none"> <li>When the boot function was executed, the CPU built-in memory capacity was exceeded.</li> </ul>	Stop	<ul style="list-style-type: none"> <li>Check and correct the boot setting.</li> <li>Delete unnecessary files in the CPU built-in memory.</li> <li>Clear the CPU built-in memory by selecting "Clear" to "Operation Setting at CPU Built-in Memory Boot" in the boot settings, and execute the boot function.</li> </ul>	Drive/file information	At power-on, at RESET
3005H	Boot function execution error	<ul style="list-style-type: none"> <li>A mismatch between the security information of the boot source file and that of the boot destination file was detected during booting.</li> </ul>	Stop	<ul style="list-style-type: none"> <li>Check and correct the security key setting.</li> <li>Delete the boot settings from the memory card parameter.</li> </ul>	Drive/file information	At power-on, at RESET
3010H	Data restoration function execution error	<ul style="list-style-type: none"> <li>The CPU module at the restoration destination does not match the backup source CPU module model.</li> </ul>	Stop	<ul style="list-style-type: none"> <li>Execute CPU module restoration with the same CPU module model as the backup source CPU module.</li> <li>Turn off b0 of SD955 (Automatic restoration execution) to disable the automatic data restoration function.</li> </ul>	CPU module data backup/restoration folder information	At power-on, at RESET
3011H	Data restoration function execution error	<ul style="list-style-type: none"> <li>Reading of backup data from an SD memory card completed with an error.</li> </ul>	Stop	<ul style="list-style-type: none"> <li>Replace the SD memory card, and execute the function again.</li> <li>The backup data may have been corrupted. Execute the data restoration function using another backup data.</li> <li>Turn off b0 of SD955 (Automatic restoration execution) to disable the automatic data restoration function.</li> </ul>	CPU module data backup/restoration folder information	At power-on, at RESET
3012H	Data restoration function execution error	<ul style="list-style-type: none"> <li>Writing of backup data to the CPU built-in memory completed with an error.</li> </ul>	Stop	<ul style="list-style-type: none"> <li>Possible cause is hardware failure of the restoration target CPU module. Execute the data restoration function to another CPU module.</li> </ul>	CPU module data backup/restoration folder information	At power-on, at RESET
3013H	Data restoration function execution error	<ul style="list-style-type: none"> <li>The system file does not exist in the backup data to be restored.</li> <li>File(s) in the system file information does not exist in the folder of the backed up data.</li> <li>The CPU module at the restoration destination does not match the backup source CPU module model.</li> </ul>	Stop	<ul style="list-style-type: none"> <li>The backup data may have been corrupted. Execute the data restoration function using another backup data.</li> <li>Turn off b0 of SD955 (Automatic restoration execution) to disable the automatic data restoration function.</li> <li>Execute CPU module restoration with the same CPU module model as the backup source CPU module.</li> </ul>	CPU module data backup/restoration folder information	At power-on, at RESET
3014H	Data restoration function execution error	<ul style="list-style-type: none"> <li>Data was restored to the CPU module where the same data with a file password has already been stored.</li> </ul>	Stop	<ul style="list-style-type: none"> <li>Delete file passwords, and execute the CPU module data backup/restoration function.</li> <li>Turn off b0 of SD955 (Automatic restoration execution) to disable the automatic data restoration function.</li> </ul>	CPU module data backup/restoration folder information	At power-on, at RESET



Error code	Error name	Error details and cause	Stop/continue	Action	Detailed information	Diagnostic timing
3015H	Data restoration function execution error	<ul style="list-style-type: none"> <li>A folder with a value that matches the restoration target date folder setting value or number folder setting value does not exist in the SD memory card.</li> <li>The restoration target data setting value is out of range.</li> <li>The restoration target date folder setting value or number folder setting value is out of range.</li> </ul>	Stop	<ul style="list-style-type: none"> <li>Check and correct the restoration target date folder setting value or number folder setting value, and execute the function again.</li> <li>Check and correct the restoration target data setting value, and execute the function again.</li> <li>Turn off b0 of SD955 (Automatic restoration execution) to disable the automatic data restoration function.</li> </ul>	CPU module data backup/restoration folder information	At power-on, at RESET
3016H	Data restoration function execution error	<ul style="list-style-type: none"> <li>The automatic data restoration function was executed with the CPU module where an SD memory card was not inserted.</li> </ul>	Stop	<ul style="list-style-type: none"> <li>Insert or re-insert an SD memory card, and execute the function again.</li> <li>Turn off b0 of SD955 (Automatic restoration execution) to disable the automatic data restoration function.</li> </ul>	CPU module data backup/restoration folder information	At power-on, at RESET
3017H	Data restoration function execution error	<ul style="list-style-type: none"> <li>The automatic data restoration function was executed exceeding the maximum memory capacity of the CPU module.</li> <li>The automatic data restoration function was executed exceeding the maximum number of files that can be stored in the CPU module.</li> </ul>	Stop	<ul style="list-style-type: none"> <li>Execute the function so that the maximum memory capacity will not be exceeded.</li> <li>Execute the function so that the maximum number of storable files will not be exceeded.</li> <li>Turn off b0 of SD955 (Automatic restoration execution) to disable the automatic data restoration function.</li> </ul>	CPU module data backup/restoration folder information	At power-on, at RESET
3018H	Data restoration function execution error	<ul style="list-style-type: none"> <li>The status (such as programs, parameters, and file structure) of the CPU module differs from that of when the data backup function was executed.</li> </ul>	Stop	<ul style="list-style-type: none"> <li>Match the CPU module status to the one at the time of backup, and execute the function again.</li> <li>Set all data as the restoration target data, and execute the data restoration function.</li> <li>Turn off b0 of SD955 (Automatic restoration execution) to disable the automatic data restoration function.</li> </ul>	CPU module data backup/restoration folder information	At power-on, at RESET
301FH	Data restoration function execution error	<ul style="list-style-type: none"> <li>The backup data is broken.</li> </ul>	Stop	<ul style="list-style-type: none"> <li>Back up the data again, and then execute CPU module auto exchange.</li> </ul>	CPU module data backup/restoration folder information	At power-on, at RESET
3040H	Update error	<ul style="list-style-type: none"> <li>The update file which is used for the firmware update is not compatible with the models and serial numbers of the target CPU module and intelligent function module.</li> </ul>	Stop	<ul style="list-style-type: none"> <li>Check the models, serial numbers, and versions of the target CPU module and intelligent function module. Use the update file compatible with them and update the firmware.</li> </ul>	Drive/file information	At power-on, at RESET
3041H	Update error	<ul style="list-style-type: none"> <li>An error was found in the update file.</li> </ul>	Stop	<ul style="list-style-type: none"> <li>Replace the update file with the correct file, and execute the update once again.</li> </ul>	Drive/file information	At power-on, at RESET
3042H	Update error	<ul style="list-style-type: none"> <li>An error is detected in the update of the extension module.</li> </ul>	Stop	<ul style="list-style-type: none"> <li>Replace the update file in the SD memory card with the correct file, and execute the update once again.</li> </ul>	System configuration information	At power-on, at RESET
3043H	Update error	<ul style="list-style-type: none"> <li>Saving the device comment file into the SD memory card failed.</li> </ul>	Stop	<ul style="list-style-type: none"> <li>Disable the write protect of the SD memory card.</li> </ul>	Drive/file information	At power-on, at RESET
3044H	Update error	<ul style="list-style-type: none"> <li>Firmware update is prohibited.</li> </ul>	Stop	<ul style="list-style-type: none"> <li>Review the firmware update prohibit settings.</li> </ul>	—	At power-on, at RESET
3045H	Update error	<ul style="list-style-type: none"> <li>Recovery of the project data saved in the SD memory card failed.</li> </ul>	Stop	<ul style="list-style-type: none"> <li>Confirm that the SD memory card used with the firmware update is inserted, and then turn the power OFF and ON again. If the data cannot be recovered, the data stored on the SD memory card may be damaged. After initializing the CPU built-in memory, write in the set of project data backed up by the customer.</li> </ul>	Drive/file information	At power-on, at RESET

Error code	Error name	Error details and cause	Stop/continue	Action	Detailed information	Diagnostic timing
3046H	Update error	<ul style="list-style-type: none"> <li>The update file (HVF extension) is not found.</li> <li>An error was found in the update file (HVF extension).</li> </ul>	Stop	<ul style="list-style-type: none"> <li>Replace the update file with the correct file (HVF extension), and execute the update once again.</li> <li>If the same error is displayed again, initialize the memory and reset the CPU module. Then, execute the update once again.</li> </ul>	Drive/file information	At power-on, at RESET
3048H	Online change error	<ul style="list-style-type: none"> <li>An error was detected when writing was executed during RUN.</li> <li>The power was restarted in an online change failure state.</li> </ul>	Stop	<ul style="list-style-type: none"> <li>Set the CPU module to STOP and write a set of project data.</li> </ul>	—	At END instruction execution
3049H	Online change error	<ul style="list-style-type: none"> <li>An error was detected when writing was executed during RUN.</li> </ul>	Stop	<ul style="list-style-type: none"> <li>Set the CPU module to STOP and write a set of project data.</li> </ul>	—	At END instruction execution
304AH	Online change error	<ul style="list-style-type: none"> <li>An error was detected when writing was executed during RUN.</li> </ul>	Stop	<ul style="list-style-type: none"> <li>Set the CPU module to STOP and write a set of project data.</li> </ul>	—	At END instruction execution
304BH	Online change error	<ul style="list-style-type: none"> <li>An error was detected when writing was executed during RUN.</li> </ul>	Stop	<ul style="list-style-type: none"> <li>Set the CPU module to STOP and write a set of project data.</li> </ul>	—	At END instruction execution
3050H	System bus error	<ul style="list-style-type: none"> <li>Communication with the module failed due to power discontinuity or the like.</li> <li>Internal bus communication failed.</li> </ul>	Stop	<ul style="list-style-type: none"> <li>Verify that the connected module is powered on.</li> <li>Power off and on the connection module and CPU module again.</li> <li>Verify that extension cables are correctly connected.</li> <li>Verify that the firmware version of the CPU module is compatible with the module where the error was detected.</li> <li>Implement anti-noise measures.</li> <li>If there is no problem, there may be a malfunction in the connected module or in the extension cables.</li> </ul>	System configuration information	At power-on, at RESET
3052H	System bus error	<ul style="list-style-type: none"> <li>The initial setting of the high-speed pulse input/output module caused an error.</li> </ul>	Stop	<ul style="list-style-type: none"> <li>Verify that extension cables are correctly connected.</li> <li>Verify that the firmware version of the CPU module is compatible with the module where the error was detected.</li> <li>Implement anti-noise measures.</li> <li>If there is no problem, there may be a malfunction in the connected module or in the extension cables.</li> </ul>	System configuration information	At power-on, at RESET
3054H	System bus error	<ul style="list-style-type: none"> <li>Detected that the all module reset command was turned on and executed the all module reset.</li> </ul>	Stop	<ul style="list-style-type: none"> <li>Check that the all module reset command is not turned on.</li> </ul>	System configuration information	At END instruction execution, at instruction execution
3055H	System bus error	<ul style="list-style-type: none"> <li>All module reset is executed.</li> <li>The positioning with the high-speed pulse input/output module caused an abnormal stop.</li> </ul>	Stop	<ul style="list-style-type: none"> <li>Review the program and check the contents of the operands used in the applied instructions.</li> <li>Verify that the connected module is powered on.</li> <li>Verify that extension cables are correctly connected.</li> <li>Verify that the firmware version of the CPU module is compatible with the module where the error was detected.</li> <li>Implement anti-noise measures.</li> <li>If there is no problem, there may be a malfunction in the connected module or in the extension cables.</li> </ul>	Error location information	At END instruction execution, at instruction execution

Error code	Error name	Error details and cause	Stop/continue	Action	Detailed information	Diagnostic timing
3056H	System bus error	<ul style="list-style-type: none"> <li>• A timeout occurred during communication with a connected module when an instruction was executed.</li> <li>• A timeout occurred during internal bus communications.</li> <li>• Detected that the power to the connected module was turned off.</li> </ul>	Continue	<ul style="list-style-type: none"> <li>• Verify that extension cables are correctly connected.</li> <li>• Verify that the firmware version of the CPU module is compatible with the module where the error was detected.</li> <li>• Implement anti-noise measures.</li> <li>• If there is no problem, there may be a malfunction in the connected module or in the extension cables.</li> <li>• When an error occurs alongside positioning function, positioning may not stop at the specified position. After removing the cause of the system bus error, perform zero return and clear error.</li> <li>• Verify that the connected module is powered on.</li> </ul>	Error location information and system configuration information	At instruction execution
3057H	System bus error	<ul style="list-style-type: none"> <li>• A timeout occurred during communication with a connected module during system processing.</li> <li>• A timeout occurred during internal bus communications.</li> <li>• Detected that the power to the connected module was turned off.</li> </ul>	Continue	<ul style="list-style-type: none"> <li>• Verify that extension cables are correctly connected.</li> <li>• Verify that the firmware version of the CPU module is compatible with the module where the error was detected.</li> <li>• Implement anti-noise measures.</li> <li>• If there is no problem, there may be a malfunction in the connected module or in the extension cables.</li> <li>• When an error occurs alongside positioning function, positioning may not stop at the specified position. After removing the cause of the system bus error, perform zero return and clear error.</li> <li>• Verify that the connected module is powered on.</li> </ul>	System configuration information	At END instruction execution, at interrupt occurrence, at module access
3060H	System bus error	<ul style="list-style-type: none"> <li>• A signal error was detected with a connected module when an instruction was executed.</li> <li>• A timeout occurred during internal bus communications.</li> </ul>	Continue	<ul style="list-style-type: none"> <li>• Verify that extension cables are correctly connected.</li> <li>• Verify that the firmware version of the CPU module is compatible with the module where the error was detected.</li> <li>• Implement anti-noise measures.</li> <li>• If there is no problem, there may be a malfunction in the connected module or in the extension cables.</li> <li>• When an error occurs alongside positioning function, positioning may not stop at the specified position. After removing the cause of the system bus error, perform zero return and clear error.</li> </ul>	Error location information and system configuration information	At instruction execution
3061H	System bus error	<ul style="list-style-type: none"> <li>• A signal error was detected during system processing.</li> <li>• A timeout occurred during internal bus communications.</li> </ul>	Continue	<ul style="list-style-type: none"> <li>• Verify that extension cables are correctly connected.</li> <li>• Verify that the firmware version of the CPU module is compatible with the module where the error was detected.</li> <li>• Implement anti-noise measures.</li> <li>• If there is no problem, there may be a malfunction in the connected module or in the extension cables.</li> <li>• When an error occurs alongside positioning function, positioning may not stop at the specified position. After removing the cause of the system bus error, perform zero return and clear error.</li> </ul>	System configuration information	At END instruction execution, at interrupt occurrence, at module access



Error code	Error name	Error details and cause	Stop/continue	Action	Detailed information	Diagnostic timing
3100H	Program error	<ul style="list-style-type: none"> <li>The program includes any instruction that cannot be used or decoded in the CPU module.</li> <li>Unicode strings are used as the input/output arguments of the FB, FUN, and FBD parts.</li> <li>Unicode strings are used in ST language.</li> </ul>	Stop	<ul style="list-style-type: none"> <li>Check the detailed information (error location information) of the error by executing module diagnostics using the engineering tool, display the error program (step) by clicking the [Error Jump] button, and check the program.</li> <li>Implement anti-noise measures.</li> <li>Re-write the program, and run the program after resetting the CPU module. If the same error appears, the hardware of the CPU module may be malfunctioning. Please consult your local Mitsubishi representative.</li> </ul>	Error location information	At power-on, at RESET
3101H	Program error	<ul style="list-style-type: none"> <li>The program contains a dedicated SFC program instruction even though it is not an SFC program.</li> </ul>	Stop	<ul style="list-style-type: none"> <li>Check the detailed information (error location information) of the error by executing module diagnostics using the engineering tool, display the error program (step) by clicking the [Error Jump] button, and check the program.</li> <li>Take measures to reduce noise.</li> <li>Write the sequence program(s) and FB program(s) to the CPU module again. Then, reset the CPU module and run it again. If the same error code is displayed again, the possible cause is a hardware failure of the CPU module. Please contact your nearest Mitsubishi Electric System Service Co., Ltd., or our branch or distributor.</li> </ul>	Error location information	At power-on, at RESET, at STOP → RUN state
3120H	Program error	<ul style="list-style-type: none"> <li>The CPU module does not support the dedicated instruction executed.</li> <li>The dedicated instructions specified in the program cannot be executed with the specified module.</li> </ul>	Stop	<ul style="list-style-type: none"> <li>Check the detailed information (error location information) of the error by executing module diagnostics using the engineering tool, display the error program (step) by clicking the [Error Jump] button, and check the program.</li> </ul>	Error location information	At power-on, at RESET, at STOP → RUN state, at instruction execution
3121H	Program error	<ul style="list-style-type: none"> <li>The number of devices used in the dedicated instruction specified in the program is incorrect.</li> </ul>	Stop	<ul style="list-style-type: none"> <li>Check the detailed information (error location information) of the error by executing module diagnostics using the engineering tool, display the error program (step) by clicking the [Error Jump] button, and check the program.</li> </ul>	Error location information	At instruction execution
3142H	Program structure error	<ul style="list-style-type: none"> <li>The temporary area was used incorrectly.</li> </ul>	Stop	<ul style="list-style-type: none"> <li>Check the detailed information (error location information) of the error by executing module diagnostics using the engineering tool, display the error program (step) by clicking the [Error Jump] button, and check the program. The step number displayed in the error location information is counted from the top of the file. (It may be different from the step number in the program displayed by the jump function.)</li> </ul>	Error location information	At instruction execution
3160H to 3163H	SFC program block, step error	<ul style="list-style-type: none"> <li>The SFC program configuration is incorrect.</li> </ul>	Stop	<ul style="list-style-type: none"> <li>Take measures to reduce noise.</li> <li>Write the SFC program to the CPU module again. Then, reset the CPU module and run it again. If the same error code is displayed again, the possible cause is a hardware failure of the CPU module. Please contact your nearest Mitsubishi Electric System Service Co., Ltd., or our branch or distributor.</li> </ul>	Error location information	At power-on, at RESET, at STOP → RUN state, at SFC program execution
3170H	SFC program block, step error	<ul style="list-style-type: none"> <li>The number of steps in the SFC program exceeds the total number of step relays (S).</li> </ul>	Stop	<ul style="list-style-type: none"> <li>Modify the program so that the number of steps in the SFC program does not exceed the total number of step relays.</li> </ul>	Error location information	At power-on, at RESET, at STOP → RUN state, at SFC program execution

Error code	Error name	Error details and cause	Stop/continue	Action	Detailed information	Diagnostic timing
3171H	SFC program block, step error	<ul style="list-style-type: none"> <li>The total number of SFC program blocks (max. step No. + 1) exceeds the total number of step relays (S).</li> </ul>	Stop	<ul style="list-style-type: none"> <li>Correct the program so that the total number of SFC program blocks (max. step No. + 1) does not exceed the total number of step relays (S).</li> </ul>	Error location information	At power-on, at RESET, at STOP → RUN state, at SFC program execution
3180H	SFC Program configuration error	<ul style="list-style-type: none"> <li>The SFC program configuration is incorrect.</li> </ul>	Stop	<ul style="list-style-type: none"> <li>Take measures to reduce noise.</li> <li>Write the SFC program to the CPU module again. Then, reset the CPU module and run it again. If the same error code is displayed again, the possible cause is a hardware failure of the CPU module. Please contact your nearest Mitsubishi Electric System Service Co., Ltd., or our branch or distributor.</li> </ul>	Error location information	At power-on, at RESET, at STOP → RUN state, at SFC program execution
3190H, 3191H	SFC Program configuration error	<ul style="list-style-type: none"> <li>The SFC program configuration is incorrect.</li> </ul>	Stop	<ul style="list-style-type: none"> <li>Take measures to reduce noise.</li> <li>Write the SFC program to the CPU module again. Then, reset the CPU module and run it again. If the same error code is displayed again, the possible cause is a hardware failure of the CPU module. Please contact your nearest Mitsubishi Electric System Service Co., Ltd., or our branch or distributor.</li> </ul>	Error location information	At instruction execution, at SFC program execution
3192H	SFC Program configuration error	<ul style="list-style-type: none"> <li>A self step number was specified for the specification destination step number for the jump transition.</li> </ul>	Stop	<ul style="list-style-type: none"> <li>Check the detailed information (error location information) of the error by executing module diagnostics using the engineering tool, display the error program (step) by clicking the [Error Jump] button, and check the program.</li> <li>Take measures to reduce noise.</li> <li>Write the SFC program to the CPU module again. Then, reset the CPU module and run it again. If the same error code is displayed again, the possible cause is a hardware failure of the CPU module. Please contact your nearest Mitsubishi Electric System Service Co., Ltd., or our branch or distributor.</li> </ul>	Error location information	At instruction execution, at SFC program execution
3193H	SFC Program configuration error	<ul style="list-style-type: none"> <li>A self step number was specified for the specification destination step number for the reset step.</li> </ul>	Stop	<ul style="list-style-type: none"> <li>Check the detailed information (error location information) of the error by executing module diagnostics using the engineering tool, display the error program (step) by clicking the [Error Jump] button, and check the program.</li> <li>Take measures to reduce noise.</li> <li>Write the SFC program to the CPU module again. Then, reset the CPU module and run it again. If the same error code is displayed again, the possible cause is a hardware failure of the CPU module. Please contact your nearest Mitsubishi Electric System Service Co., Ltd., or our branch or distributor.</li> </ul>	Error location information	At instruction execution, at SFC program execution
31A0H	SFC program block, step specification error	<ul style="list-style-type: none"> <li>An attempt was made to start an SFC program block that was already running.</li> </ul>	Stop	<ul style="list-style-type: none"> <li>Check the detailed information (error location information) of the error by executing module diagnostics using the engineering tool, display the error program (step) by clicking the [Error Jump] button, and check the program.</li> <li>Turn on SM321 (Start/stop SFC program) if it is off.</li> </ul>	Error location information	At instruction execution, at SFC program execution

Error code	Error name	Error details and cause	Stop/continue	Action	Detailed information	Diagnostic timing
31A1H	SFC program block, step specification error	<ul style="list-style-type: none"> <li>A non-existent SFC program block was specified.</li> </ul>	Stop	<ul style="list-style-type: none"> <li>Check the detailed information (error location information) of the error by executing module diagnostics using the engineering tool, display the error program (step) by clicking the [Error Jump] button, and check the program.</li> <li>Turn on SM321 (Start/stop SFC program) if it is off.</li> <li>Check the SFC program has existed.</li> <li>Check the execution status of the SFC program.</li> </ul>	Error location information	At instruction execution, at SFC program execution
31A2H	SFC program block, step specification error	<ul style="list-style-type: none"> <li>The specified block exceeds the range that can be used in the SFC program.</li> </ul>	Stop	<ul style="list-style-type: none"> <li>Check the detailed information (error location information) of the error by executing module diagnostics using the engineering tool, display the error program (step) by clicking the [Error Jump] button, and check the program.</li> <li>Turn on SM321 (Start/stop SFC program) if it is off.</li> </ul>	Error location information	At instruction execution, at SFC program execution
31B1H	SFC program block, step specification error	<ul style="list-style-type: none"> <li>A non-existent SFC program step was specified.</li> </ul>	Stop	<ul style="list-style-type: none"> <li>Check the detailed information (error location information) of the error by executing module diagnostics using the engineering tool, display the error program (step) by clicking the [Error Jump] button, and check the program.</li> <li>Turn on SM321 (Start/stop SFC program) if it is off.</li> <li>Check the SFC program has existed.</li> <li>Check the execution status of the SFC program.</li> </ul>	Error location information	At instruction execution, at SFC program execution
31B2H	SFC program block, step specification error	<ul style="list-style-type: none"> <li>The specified step exceeds the range that can be used in the SFC program.</li> </ul>	Stop	<ul style="list-style-type: none"> <li>Check the detailed information (error location information) of the error by executing module diagnostics using the engineering tool, display the error program (step) by clicking the [Error Jump] button, and check the program.</li> <li>Turn on SM321 (Start/stop SFC program) if it is off.</li> </ul>	Error location information	At instruction execution, at SFC program execution
31B3H	SFC program block, step specification error	<ul style="list-style-type: none"> <li>The number of simultaneous active block steps that can be specified in the SFC program exceeds the permissible value.</li> </ul>	Stop	<ul style="list-style-type: none"> <li>Check the detailed information (error location information) of the error by executing module diagnostics using the engineering tool, display the error program (step) by clicking the [Error Jump] button, and check the program.</li> </ul>	Error location information	At instruction execution, at SFC program execution
31B4H	SFC program block, step specification error	<ul style="list-style-type: none"> <li>The total number of simultaneous active steps that can be specified in the SFC program exceeds the permissible value.</li> </ul>	Stop	<ul style="list-style-type: none"> <li>Check the detailed information (error location information) of the error by executing module diagnostics using the engineering tool, display the error program (step) by clicking the [Error Jump] button, and check the program.</li> </ul>	Error location information	At instruction execution, at SFC program execution
31B5H	SFC program block, step specification error	<ul style="list-style-type: none"> <li>SET Sn/BLm\Sn, RST Sn/BLm\Sn, OUT Sn/BLm\Sn instructions were specified for the self step in the step operation output.</li> </ul>	Stop	<ul style="list-style-type: none"> <li>Check the detailed information (error location information) of the error by executing module diagnostics using the engineering tool, display the error program (step) by clicking the [Error Jump] button, and check the program.</li> </ul>	Error location information	At instruction execution, at SFC program execution
3200H	Program execution error	<ul style="list-style-type: none"> <li>The device/label assignment does not match the device/label assignment in the program. (After the device assignment was changed, only the parameters were written to the CPU module.)</li> </ul>	Stop	<ul style="list-style-type: none"> <li>If the index modification setting of the PLC parameter is changed, write the parameter and program file to the CPU module at the same time.</li> </ul>	Drive/file information	At power-on, at RESET
3201H	Program execution error	<ul style="list-style-type: none"> <li>Multiple program files exist although the program setting of the CPU parameter is not set.</li> </ul>	Stop	<ul style="list-style-type: none"> <li>Set the program in the program setting of the CPU parameter.</li> <li>Delete the unnecessary program files.</li> </ul>	Drive/file information	At power-on, at RESET

Error code	Error name	Error details and cause	Stop/continue	Action	Detailed information	Diagnostic timing
3202H	Program execution error	<ul style="list-style-type: none"> <li>The program file is invalid or the file does not contain a program.</li> <li>"Yes" is set for the intrinsic property of a subroutine type FB, "Use MC/MCR to control EN".</li> <li>The SFC program is set for the CPU module that does not support the SFC program.</li> <li>The SFC program is set, but the CPU parameter program setting is not set to "Use".</li> </ul>	Stop	<ul style="list-style-type: none"> <li>Write the correct program file.</li> <li>Change the intrinsic property of the subroutine type FB, "Use MC/MCR to control EN", to "No", and write the program again.</li> <li>Replace the CPU module with a module of a firmware version that can execute the subroutine type FB whose intrinsic property, "Use MC/MCR to control EN", is changed to "Yes".</li> <li>Change to a CPU module with a firmware version that supports the SFC program.</li> <li>Change the SFC program setting of CPU parameter to "Use" and rewrite the parameter.</li> </ul>	Drive/file information	At power-on, at RESET
3203H	Program execution error	<ul style="list-style-type: none"> <li>No program file exists.</li> </ul>	Stop	<ul style="list-style-type: none"> <li>Write a program file.</li> </ul>	—	At power-on, at RESET
3204H	Program execution error	<ul style="list-style-type: none"> <li>Two or more SFC programs were executed.</li> </ul>	Stop	<ul style="list-style-type: none"> <li>Ensure that only one SFC program is executed.</li> </ul>	Drive/file information	At power-on, at RESET
3210H	Program execution error	<ul style="list-style-type: none"> <li>A program with a number of steps exceeding the maximum number is written.</li> </ul>	Stop	<ul style="list-style-type: none"> <li>Reduce the number of steps in the program.</li> </ul>	—	At power-on, at RESET
3211H	Program execution error	<ul style="list-style-type: none"> <li>An FB program larger than the internal memory capacity was written.</li> </ul>	Stop	<ul style="list-style-type: none"> <li>Reduce the number of steps in the FB program.</li> </ul>	—	At power-on, at RESET
3212H	Program execution error	<ul style="list-style-type: none"> <li>No program setting is found in the parameters.</li> </ul>	Stop	<ul style="list-style-type: none"> <li>Specify the program to execute in the parameters.</li> </ul>	—	At power-on, at RESET
3213H	Program execution error	<ul style="list-style-type: none"> <li>The parameter set value is out of range.</li> </ul>	Stop	<ul style="list-style-type: none"> <li>To use this parameter, a new firmware version of the CPU module is required. Replace the CPU module or perform version upgrade.</li> </ul>	Parameter information	At power-on, at RESET
3221H, 3222H	SFC program execution error	<ul style="list-style-type: none"> <li>The SFC program cannot be executed.</li> </ul>	Stop	<ul style="list-style-type: none"> <li>Take measures against noise.</li> <li>Write the SFC program again, reset the CPU module, and then run. If the same error is displayed again, there may be a hardware failure in the CPU module. Please contact your nearest Mitsubishi Electric System Service Co., Ltd., or our branch or distributor.</li> </ul>	Drive/file information	At power-on, at RESET, at STOP → RUN state
3302H	Pointer setting error	<ul style="list-style-type: none"> <li>Duplicate pointers are programmed.</li> </ul>	Stop	<ul style="list-style-type: none"> <li>Modify the program to not use duplicate pointers in a program.</li> </ul>	Error location information	At power-on, at RESET
3320H	Interrupt pointer setting error	<ul style="list-style-type: none"> <li>Duplicate interrupt pointers are programmed.</li> </ul>	Stop	<ul style="list-style-type: none"> <li>Modify the program to not use duplicate interrupt pointers in a program.</li> </ul>	Error location information	At power-on, at RESET
3340H	FOR-NEXT instruction error	<ul style="list-style-type: none"> <li>The relationship between FOR and NEXT instructions is invalid.</li> </ul>	Stop	<ul style="list-style-type: none"> <li>Make sure that FOR and NEXT instructions are each executed the same number of times. In addition, check the FOR syntax for any invalid jump instructions.</li> </ul>	Error location information	At END instruction execution
3341H	FOR-NEXT instruction error	<ul style="list-style-type: none"> <li>The relationship between FOR and NEXT instructions is invalid.</li> </ul>	Stop	<ul style="list-style-type: none"> <li>Make sure that FOR and NEXT instructions are each executed the same number of times. In addition, check syntax for any invalid jump instructions.</li> </ul>	Error location information	At END instruction execution
3342H	FOR-NEXT instruction error	<ul style="list-style-type: none"> <li>A BREAK instruction was executed outside the FOR syntax.</li> </ul>	Stop	<ul style="list-style-type: none"> <li>The BREAK instruction must be executed inside the FOR syntax.</li> </ul>	Error location information	At instruction execution
3360H	Nesting depth error	<ul style="list-style-type: none"> <li>The number of nesting levels of subroutine calls is invalid.</li> </ul>	Stop	<ul style="list-style-type: none"> <li>Make sure that the number of nesting levels is 16 or lower. In addition, check subroutine programs for any invalid jump instructions.</li> </ul>	Error location information	At END instruction execution, at instruction execution
3361H	Nesting depth error	<ul style="list-style-type: none"> <li>The number of nesting levels of FOR instructions is invalid.</li> </ul>	Stop	<ul style="list-style-type: none"> <li>Make sure that the number of nesting levels is 16 or lower. In addition, check the FOR syntax for any invalid jump instructions.</li> </ul>	Error location information	At END instruction execution, at instruction execution

Error code	Error name	Error details and cause	Stop/continue	Action	Detailed information	Diagnostic timing
3362H	Nesting depth error	<ul style="list-style-type: none"> <li>The number of nesting levels of DI instructions is invalid.</li> </ul>	Continue/stop <sup>*1</sup>	<ul style="list-style-type: none"> <li>Make sure that the number of nesting levels is 16 or lower. In addition, check the relationship between DI and EI instructions.</li> </ul>	Error location information	At END instruction execution, at instruction execution
3380H	Pointer execution error	<ul style="list-style-type: none"> <li>There is no pointer to the jump destination.</li> </ul>	Stop	<ul style="list-style-type: none"> <li>Specify the correct jump destination in the program.</li> </ul>	Error location information	At instruction execution
3381H	Pointer execution error	<ul style="list-style-type: none"> <li>There is an END, FEND, GOEND, or STOP instruction in a subroutine program.</li> </ul>	Stop	<ul style="list-style-type: none"> <li>The END, FEND, GOEND, and STOP instructions can be executed only in the main routine program.</li> </ul>	Error location information	At END instruction execution
3382H	Pointer execution error	<ul style="list-style-type: none"> <li>A RET instruction was executed without a CALL or XCALL instruction executed.</li> </ul>	Stop	<ul style="list-style-type: none"> <li>Check where there is any invalid jump to subroutine programs.</li> </ul>	Error location information	At instruction execution
33A0H	Interrupt pointer execution error	<ul style="list-style-type: none"> <li>The interrupt pointer corresponding to the interrupt input does not exist</li> </ul>	Stop	<ul style="list-style-type: none"> <li>Check if the program corresponding to the interrupt pointer number set in the module parameters exists.</li> </ul>	—	At instruction execution
33D0H	Temporary area exceeded	<ul style="list-style-type: none"> <li>The size of allocated temporary area exceeds the maximum size.</li> </ul>	Stop	<ul style="list-style-type: none"> <li>The usage of the temporary area can be reduced by setting the option of the engineering tool, "Collectively allocate temporary area to optimize the number of steps", to "No".</li> <li>Check the detailed information (error location information) using the module diagnostics of the engineering tool, and, if the program block displayed by Error Jump or the destination of Error Jump is a function block/function, divide the source program block into multiple program blocks.</li> <li>Change the CPU parameter, program capacity setting, to "128000 steps" to increase the capacity of the temporary area. (Compatible with only firmware version 1.100 or later of FX5U/FX5UC module)</li> </ul>	Error location information	At instruction execution
33E0H	Program structure error	<ul style="list-style-type: none"> <li>The relationship between LD/LDI/LDP/LDF/LDPI/LDFI and ANB/ORB instructions is incorrect.</li> </ul>	Stop	<ul style="list-style-type: none"> <li>Rewrite the program file.</li> </ul>	Error location information	At power-on, at RESET
33E1H	Program structure error	<ul style="list-style-type: none"> <li>The relationship among MPS, MRD, and MPP is incorrect.</li> </ul>	Stop	<ul style="list-style-type: none"> <li>Rewrite the program file.</li> </ul>	Error location information	At power-on, at RESET
33E2H	Program structure error	<ul style="list-style-type: none"> <li>An instruction that should start from the bus line is not connected to the bus line.</li> </ul>	Stop	<ul style="list-style-type: none"> <li>Rewrite the program file.</li> </ul>	Error location information	At power-on, at RESET
33E3H	Program structure error	<ul style="list-style-type: none"> <li>The relationship between FOR and NEXT instructions is incorrect.</li> </ul>	Stop	<ul style="list-style-type: none"> <li>Modify the program so that the mutual relationship between instructions becomes correct.</li> </ul>	Error location information	At power-on, at RESET
33E4H	Program structure error	<ul style="list-style-type: none"> <li>The relationship between MC and MCR instructions is incorrect.</li> </ul>	Stop	<ul style="list-style-type: none"> <li>Modify the program so that the mutual relationship between instructions becomes correct.</li> </ul>	Error location information	At power-on, at RESET
33E5H	Program structure error	<ul style="list-style-type: none"> <li>The relationship between STL and other instructions is incorrect.</li> </ul>	Stop	<ul style="list-style-type: none"> <li>Revise the program so that relationships between STL instruction and RETSTL instruction are correct.</li> <li>Revise the program so that the MC/MCR instruction is not used between STL instruction and RETSTL instruction. (Error also occurs when a macro-type FB that specifies "Yes" for "Use MC/MCR to Control EN" from FB property, is placed between STL instruction to RETSTL instruction)</li> <li>Revise the program not to use STL and RETSTL instructions in interrupt program.</li> </ul>	Error location information	At power-on, at RESET

Error code	Error name	Error details and cause	Stop/continue	Action	Detailed information	Diagnostic timing
33E6H	Program structure error	• An instruction or interrupt pointer that cannot be used in the main routine program is used.	Stop	• Modify the program so that instruction or pointer use becomes correct.	Error location information	At power-on, at RESET
33E7H	Program structure error	• The relationship among a global pointer, interrupt pointer, and return instruction is incorrect.	Stop	• Modify the program so that the mutual relationship between pointer and return instruction becomes correct.	Error location information	At power-on, at RESET
33E8H	Program structure error	• An instruction that cannot be used in an interrupt routine program is used.	Stop	• Modify the program so that no instruction whose use is disabled by the interrupt routine program is used.	Error location information	At power-on, at RESET
33F1H	Program structure error	• The program structure of the ST language, FB, and functions is invalid.	Stop	• Check the syntax of the ST language, FB, and functions.	Error location information	At END instruction execution, at interrupt occurrence
33F2H	Program structure error	• The program structure of the ST language, FB, and functions is invalid.	Stop	• Check the syntax of the ST language, FB, and functions.	Error location information	At instruction execution
33F3H	Program structure error	• More than two STL instructions for the same S number are programmed.	Stop	• Recheck the structure of the step ladder.	Error location information	At power-on, at RESET, at STOP → RUN state
33F4H	Program structure error	• A device used as an instruction operand is outside the allowable device range.	Stop	• Check the device range and modify the program.	Error location information	At power-on, at RESET, at STOP → RUN state
33F5H	Program structure error	• The step ladder instruction is programmed in the project for which the SFC program setting of the CPU parameter is set to "Use".	Stop	• The SFC program cannot be programmed at the same time as the step ladder instruction (STL, RETSTL) or initial state instruction (IST). Delete the instruction, or delete the SFC program and change the SFC program settings.	Error location information	At power-on, at RESET, at STOP → RUN state
3400H	Operation error	• A value of 0 was input as a divisor in an applied instruction.	Continue/stop* <sup>1</sup>	• Review the data specified as the divisor in the applied instruction.	Error location information	At instruction execution
3401H	Operation error	• Data that cannot be converted was input in an applied instruction.	Continue/stop* <sup>1</sup>	• Review the data specified in the applied instruction.	Error location information	At instruction execution
3402H	Operation error	• A value of -0, a denormalized number, a non-number, or $\pm\infty$ was input in an applied instruction.	Continue/stop* <sup>1</sup>	• Review the data specified in the applied instruction.	Error location information	At instruction execution
3403H	Operation error	• An overflow occurred in an applied instruction.	Continue/stop* <sup>1</sup>	• Review the data specified in the applied instruction.	Error location information	At instruction execution
3404H	Operation error	• A string that is not supported in the instruction was specified.	Continue/stop* <sup>1</sup>	• Check the detailed information (error location information) of the error by executing module diagnostics using the engineering tool, display the error program (step) by clicking the [Error Jump] button, and correct the program.	Error location information	At instruction execution
3405H	Operation error	• Data that is outside the allowable range was input in an applied instruction.	Continue/stop* <sup>1</sup>	• Review the data specified in the applied instruction.	Error location information	At instruction execution
3406H	Operation error	• The output result is outside the allowable device range in an applied instruction.	Continue/stop* <sup>1</sup>	• Review the data specified in the applied instruction.	Error location information	At instruction execution
3420H	Operation error	• A module access device is specified to both (s) and (d) in a BMOV instruction or BLKMOVB instruction.	Continue/stop* <sup>1</sup>	• Review the device specified in the BMOV instruction or BLKMOVB instruction.	Error location information	At instruction execution

Error code	Error name	Error details and cause	Stop/continue	Action	Detailed information	Diagnostic timing
3421H	Operation error	<ul style="list-style-type: none"> <li>When writing data to the data memory by using the SP.DEVST instruction, the number of writes per day exceeded the number set in SD771.</li> <li>The value set in SD771 is out of range.</li> </ul>	Continue/stop <sup>*1</sup>	<ul style="list-style-type: none"> <li>Check if the SP.DEVST instruction is used correctly.</li> <li>Execute the SP.DEVST instruction again on another day, or change the value in SD771.</li> <li>Set the value in SD771 within the settable range.</li> </ul>	Error location information	At instruction execution
3426H	Operation error	<ul style="list-style-type: none"> <li>Two or more "*" are specified in the specified file name (until the period) or in the extension.</li> <li>"*" and "?" are mixed in the specified file name (until the period) or extension the extension.</li> <li>A wildcard specification character ("*", "?") is included in a part that cannot be specified.</li> <li>The specified file name has a file extension that cannot be transferred.</li> <li>The file name is not specified.</li> <li>The delimiter of the drive number is specified with symbol other than ":" or "/".</li> </ul>	Continue/stop <sup>*1</sup>	<ul style="list-style-type: none"> <li>Check how to specify wildcard specification characters.</li> <li>Check the file extensions which can be transferred.</li> <li>Specify the file name.</li> <li>Specify the drive number delimiter with ":" or "/".</li> </ul>	Error location information	At instruction execution
3427H	Operation error	<ul style="list-style-type: none"> <li>The combination of execution/completion type and data type specified in (d1) of the control data for the SP.FREAD instruction and SP.FWRITE instruction is not allowable.</li> <li>The combination of execution/completion type, write start position, and file position specified in (d1) of the control data for the SP.FWRITE instruction is not allowable.</li> </ul>	Continue/stop <sup>*1</sup>	<ul style="list-style-type: none"> <li>Check the detailed information (error location information) of the error by executing module diagnostics using the engineering tool, display the error program (step) by clicking the [Error Jump] button, and check the program that can be specified.</li> </ul>	Error location information	At instruction execution
3430H	Operation error	<ul style="list-style-type: none"> <li>The instruction was executed without setting the necessary parameters for executing the instruction.</li> </ul>	Continue/stop <sup>*1</sup>	<ul style="list-style-type: none"> <li>Set the necessary parameters to execute the instruction.</li> </ul>	Error location information	At instruction execution
3500H	Operation error	<ul style="list-style-type: none"> <li>A value outside the allowable range was set to the sampling time (TS).</li> </ul>	Continue/stop <sup>*1</sup>	<ul style="list-style-type: none"> <li>Check the contents of the parameters.</li> </ul>	Error location information	At instruction execution
3502H	Operation error	<ul style="list-style-type: none"> <li>A value outside the allowable range was set to the input filter constant (<math>\alpha</math>).</li> </ul>	Continue/stop <sup>*1</sup>	<ul style="list-style-type: none"> <li>Check the contents of the parameters.</li> </ul>	Error location information	At instruction execution
3503H	Operation error	<ul style="list-style-type: none"> <li>A value outside the allowable range was set to the proportional gain (KP).</li> </ul>	Continue/stop <sup>*1</sup>	<ul style="list-style-type: none"> <li>Check the contents of the parameters.</li> </ul>	Error location information	At instruction execution
3504H	Operation error	<ul style="list-style-type: none"> <li>A value outside the allowable range was set to the integral time (TI).</li> </ul>	Continue/stop <sup>*1</sup>	<ul style="list-style-type: none"> <li>Check the contents of the parameters.</li> </ul>	Error location information	At instruction execution
3505H	Operation error	<ul style="list-style-type: none"> <li>A value outside the allowable range was set to the derivative gain (KD).</li> </ul>	Continue/stop <sup>*1</sup>	<ul style="list-style-type: none"> <li>Check the contents of the parameters.</li> </ul>	Error location information	At instruction execution
3506H	Operation error	<ul style="list-style-type: none"> <li>A value outside the allowable range was set to the derivative time (TD).</li> </ul>	Continue/stop <sup>*1</sup>	<ul style="list-style-type: none"> <li>Check the contents of the parameters.</li> </ul>	Error location information	At instruction execution
350AH	Operation error	<ul style="list-style-type: none"> <li>The sampling time is shorter than the scan time.</li> </ul>	Continue/stop <sup>*1</sup>	<ul style="list-style-type: none"> <li>The operation is continued in the condition "sampling time (TS) = cyclic time (scan time)".</li> </ul>	Error location information	At instruction execution

Error code	Error name	Error details and cause	Stop/continue	Action	Detailed information	Diagnostic timing
350CH	Operation error	<ul style="list-style-type: none"> <li>The variation of measured value is greater than the maximum value or lower than the minimum value.</li> </ul>	Continue/stop <sup>*1</sup>	<ul style="list-style-type: none"> <li>The operation is continued with the maximum or minimum value.</li> </ul>	Error location information	At instruction execution
350DH	Operation error	<ul style="list-style-type: none"> <li>The deviation is greater than the maximum value or lower than the minimum value.</li> </ul>	Continue/stop <sup>*1</sup>	<ul style="list-style-type: none"> <li>The operation is continued with the maximum or minimum value.</li> </ul>	Error location information	At instruction execution
350EH	Operation error	<ul style="list-style-type: none"> <li>The integral result is greater than the maximum value or lower than the minimum value.</li> </ul>	Continue/stop <sup>*1</sup>	<ul style="list-style-type: none"> <li>The operation is continued with the maximum or minimum value.</li> </ul>	Error location information	At instruction execution
350FH	Operation error	<ul style="list-style-type: none"> <li>The derivative value is greater than the maximum value or lower than the minimum value due to the derivative gain (KD).</li> </ul>	Continue/stop <sup>*1</sup>	<ul style="list-style-type: none"> <li>The operation is continued with the maximum or minimum value.</li> </ul>	Error location information	At instruction execution
3510H	Operation error	<ul style="list-style-type: none"> <li>The derivative result is greater than the maximum value or lower than the minimum value.</li> </ul>	Continue/stop <sup>*1</sup>	<ul style="list-style-type: none"> <li>The operation is continued with the maximum or minimum value.</li> </ul>	Error location information	At instruction execution
3511H	Operation error	<ul style="list-style-type: none"> <li>The PID operation result is greater than the maximum value or lower than the minimum value.</li> </ul>	Continue/stop <sup>*1</sup>	<ul style="list-style-type: none"> <li>The operation is continued with the maximum or minimum value.</li> </ul>	Error location information	At instruction execution
3512H	Operation error	<ul style="list-style-type: none"> <li>The output upper limit value is lower than the output lower limit value.</li> </ul>	Continue/stop <sup>*1</sup>	<ul style="list-style-type: none"> <li>Calculation is continued with the output upper limit value and output lower limit value transposed.</li> </ul>	Error location information	At instruction execution
3513H	Operation error	<ul style="list-style-type: none"> <li>The input variation alarm set value or output variation alarm set value is outside the allowable range.</li> </ul>	Continue/stop <sup>*1</sup>	<ul style="list-style-type: none"> <li>The operation is continued without alarm output.</li> </ul>	Error location information	At instruction execution
3514H	Operation error	<ul style="list-style-type: none"> <li>The auto tuning result in the step response method is abnormal.</li> <li>The deviation at end of auto tuning is 1/3 or less of the deviation at start of auto tuning.</li> </ul>	Continue/stop <sup>*1</sup>	<ul style="list-style-type: none"> <li>Check the measured value and target value, and then execute auto tuning again.</li> </ul>	Error location information	At instruction execution
3515H	Operation error	<ul style="list-style-type: none"> <li>The operation direction estimated from the measured value at the start of auto tuning in the step response method was different from the actual operation direction of the output during auto tuning.</li> </ul>	Continue/stop <sup>*1</sup>	<ul style="list-style-type: none"> <li>Correct the relationship among the target value, output value for auto tuning, and the measured value, and then execute auto tuning again.</li> </ul>	Error location information	At instruction execution
3516H	Operation error	<ul style="list-style-type: none"> <li>Because the set value fluctuated during auto tuning in the step response method, auto tuning was not executed correctly.</li> </ul>	Continue/stop <sup>*1</sup>	<ul style="list-style-type: none"> <li>Set the sampling time to a value larger than the output change cycle, or set a larger value for the input filter constant. After changing the setting, execute auto tuning again.</li> </ul>	Error location information	At instruction execution
3517H	Operation error	<ul style="list-style-type: none"> <li>The output set value upper limit for auto tuning is lower than the lower limit.</li> </ul>	Continue/stop <sup>*1</sup>	<ul style="list-style-type: none"> <li>Verify that the target setting contents are correct.</li> </ul>	Error location information	At instruction execution
3518H	Operation error	<ul style="list-style-type: none"> <li>A value outside the allowable range was set to the PV threshold for auto tuning.</li> </ul>	Continue/stop <sup>*1</sup>	<ul style="list-style-type: none"> <li>Verify that the target setting contents are correct.</li> </ul>	Error location information	At instruction execution
3519H	Operation error	<ul style="list-style-type: none"> <li>Operation is not performed normally because devices occupied by the PID instruction were overwritten.</li> </ul>	Continue/stop <sup>*1</sup>	<ul style="list-style-type: none"> <li>Ensure that devices occupied by PID instruction are not overwritten in the program.</li> </ul>	Error location information	At instruction execution



Error code	Error name	Error details and cause	Stop/continue	Action	Detailed information	Diagnostic timing
351AH	Operation error	<ul style="list-style-type: none"> <li>The auto tuning time is longer than necessary.</li> </ul>	Continue/stop*1	<ul style="list-style-type: none"> <li>Increase the difference (ULV - LLV) between the upper limit and lower limit of the output value for auto tuning, set a smaller value to the input filter constant (<math>\alpha</math>), or set a smaller value to the PV threshold (SHPV) for auto tuning, and then check the result for improvement.</li> </ul>	Error location information	At instruction execution
351BH	Operation error	<ul style="list-style-type: none"> <li>The variation of the measured value is too small compared with the output value.</li> </ul>	Continue/stop*1	<ul style="list-style-type: none"> <li>Multiply the measured value (PV) by "10" so that the variation of the measured value will increase during auto tuning. The operation is continued with KP = 32767.</li> </ul>	Error location information	At instruction execution
351CH	Operation error	<ul style="list-style-type: none"> <li>The auto tuning time is longer than necessary.</li> </ul>	Continue/stop*1	<ul style="list-style-type: none"> <li>Increase the difference (ULV - LLV) between the upper limit and lower limit of the output value for auto tuning, set a smaller value to the input filter constant (<math>\alpha</math>), or set a smaller value to the PV threshold (SHPV) for auto tuning, and then check the result for improvement. The operation is continued with TI = 32767.</li> </ul>	Error location information	At instruction execution
351DH	Operation error	<ul style="list-style-type: none"> <li>The auto tuning time is longer than necessary.</li> </ul>	Continue/stop*1	<ul style="list-style-type: none"> <li>Increase the difference (ULV - LLV) between the upper limit and lower limit of the output value for auto tuning, set a smaller value to the input filter constant (<math>\alpha</math>), or set a smaller value to the PV threshold (SHPV) for auto tuning, and then check the result for improvement. The operation is continued with TD = 32767.</li> </ul>	Error location information	At instruction execution
351EH	Operation error	<ul style="list-style-type: none"> <li>The set value of the timeout time after maximum ramp for auto tuning is abnormal.</li> </ul>	Continue/stop*1	<ul style="list-style-type: none"> <li>Correct the value so that the timeout time after maximum ramp for auto tuning is within the setting range.</li> </ul>	Error location information	At instruction execution
3580H	Operation error	<ul style="list-style-type: none"> <li>An instruction that cannot be used in an interrupt routine program is used.</li> </ul>	Continue/stop*1	<ul style="list-style-type: none"> <li>Modify the program so that no instruction whose use is disabled by the interrupt routine program is used.</li> </ul>	Error location information	At instruction execution
3581H	Operation error	<ul style="list-style-type: none"> <li>Modules subsequent to the bus conversion module are using an operand that cannot be used.</li> </ul>	Continue/stop*1	<ul style="list-style-type: none"> <li>Modify the program so that no operand whose use is disabled for modules subsequent to the bus conversion module is used.</li> </ul>	Error location information	At instruction execution
3582H	Operation error	<ul style="list-style-type: none"> <li>An instruction that cannot be used in an interrupt routine program is used.</li> </ul>	Continue/stop*1	<ul style="list-style-type: none"> <li>Modify the program so that no instruction whose use is disabled by the interrupt routine program is used.</li> </ul>	Error location information	At instruction execution
3583H	Operation error	<ul style="list-style-type: none"> <li>A CPU module with a serial No. incompatible with the function was used.</li> </ul>	Continue/stop*1	<ul style="list-style-type: none"> <li>Use a CPU module with a serial No. compatible with the function. For details, refer to the manual.</li> </ul>	Error location information	At instruction execution
3584H	Operation error	<ul style="list-style-type: none"> <li>The writing failed because the write protect switch of the SD memory card is enabled (the writing is prohibited).</li> </ul>	Continue/stop*1	<ul style="list-style-type: none"> <li>Disable the write protect switch of the SD memory card.</li> </ul>	Error location information Drive/file information	At instruction execution
3585H	Operation error	<ul style="list-style-type: none"> <li>The data exceeded the maximum data storage capacity.</li> </ul>	Continue/stop*1	<ul style="list-style-type: none"> <li>Increase the SD memory card free space capacity, and execute the function again.</li> <li>Delete files in the SD memory card, and execute the function again.</li> <li>Delete the backup data in the SD memory card, and execute the function again.</li> </ul>	Error location information Drive/file information	At instruction execution
3586H	Operation error	<ul style="list-style-type: none"> <li>The SD memory card has not been inserted.</li> <li>The SD memory card turned to disable status by SM606 (SD memory card forcibly disable command).</li> <li>The SD memory card module is not mounted.</li> </ul>	Continue/stop*1	<ul style="list-style-type: none"> <li>Insert or re-insert an SD memory card, and execute the function again.</li> <li>Release the SD memory card disable status, and execute the function again.</li> <li>If the SD memory card module is not mounted, power off the programmable controller, mount the SD memory card module, and power on the programmable controller again.</li> </ul>	Error location information Drive/file information	At instruction execution

Error code	Error name	Error details and cause	Stop/continue	Action	Detailed information	Diagnostic timing
3587H	Operation error	<ul style="list-style-type: none"> <li>An error was found in the data of the file.</li> <li>Writing/reading to the SD memory card did not finished correctly.</li> <li>The SD memory card module is not mounted.</li> </ul>	Continue/stop <sup>*1</sup>	<ul style="list-style-type: none"> <li>Re-create the file.</li> <li>Check that the SD memory card is mounted correctly, and execute the function again.</li> <li>Re-insert the SD memory card, and execute the function again.</li> <li>If the SD memory card module is not mounted, power off the programmable controller, mount the SD memory card module, and power on the programmable controller again.</li> </ul>	Error location information Drive/file information	At instruction execution
3588H	Operation error	<ul style="list-style-type: none"> <li>The specified file does not exist.</li> </ul>	Continue/stop <sup>*1</sup>	<ul style="list-style-type: none"> <li>Check the file, and execute the function again.</li> </ul>	Error location information Drive/file information	At instruction execution
3600H	Operation error	<ul style="list-style-type: none"> <li>The channel specified by instructions using communication functions or high-speed I/O does not have the appropriate parameter.</li> <li>The appropriate parameters are set for the specified channel, but the appropriate board, adapter and module are not installed.</li> </ul>	Continue/stop <sup>*1</sup>	<ul style="list-style-type: none"> <li>Verify that the parameter setting of the channel specified by instructions using communication functions or high-speed I/O is correct.</li> <li>Verify that the appropriate board, adapter and module are installed on the specified channel.</li> </ul>	Error location information	At instruction execution
3611H to 361CH	CH1 to CH12 pulse width, period setting error	<ul style="list-style-type: none"> <li>The set value of pulse width, cycle, or number of output pulses is abnormal.</li> </ul>	Continue/stop <sup>*1</sup>	<ul style="list-style-type: none"> <li>Correct the set value so that the pulse width, cycle, and number of output pulses are within the setting range.</li> </ul>	Error location information and system configuration information	At END instruction execution
3621H to 362CH	Axes 1 to 12 limit detection error	<ul style="list-style-type: none"> <li>Both the forward and reverse limits were detected at the time of zero return or the limit of the moving direction was detected after the near-point dog was detected.</li> </ul>	Continue/stop <sup>*1</sup>	<ul style="list-style-type: none"> <li>Recheck the relationship between the near-point dog and limits.</li> </ul>	Error location information and system configuration information	At END instruction execution, at instruction execution
3631H to 363CH	Axes 1 to 12 positioning address error	<ul style="list-style-type: none"> <li>The 32-bit range was exceeded when the unit of the positioning address was converted.</li> <li>The 32-bit range was exceeded when the unit of the zero-point address was converted.</li> <li>The total transfer distance before and after the interrupt of the DVIT/DDVIT instruction or 1-speed positioning with interruption exceeded 7FFFFFFH. Or, when the operation was started, the positioning address was set to 0.</li> <li>Pulses of 7FFFFFFH or greater are needed to specify an absolute address.</li> </ul>	Continue/stop <sup>*1</sup>	<ul style="list-style-type: none"> <li>Correct values so that the positioning address and starting point address (only if homing) are within the setting range.</li> </ul>	Error location information and system configuration information	At interrupt occurrence, at instruction execution
3641H to 364CH	Axes 1 to 12 command speed error	<ul style="list-style-type: none"> <li>The 32-bit range was exceeded when the unit of the maximum speed was converted.</li> <li>When the positioning was started, the speed was set to 0.</li> </ul>	Continue/stop <sup>*1</sup>	<ul style="list-style-type: none"> <li>Correct values so that the maximum speed and command speed are within the setting range.</li> </ul>	Error location information and system configuration information	At instruction execution

Error code	Error name	Error details and cause	Stop/continue	Action	Detailed information	Diagnostic timing
3651H to 365CH	Axes 1 to 12 error stop (deceleration stop)	<ul style="list-style-type: none"> <li>When pulses were being output or positioning was starting, the PLC decelerated and stopped the pulse output due to the limit of the moving direction. (The PLSY/DPLSY instruction stops pulse output immediately at both limits.)</li> <li>When pulses were being output or positioning was starting, the PLC decelerated and stopped the pulse output by the pulse decelerate and stop command.</li> <li>When pulses were being output, the command speed was changed to 0.</li> </ul>	Continue/stop <sup>*1</sup>	<ul style="list-style-type: none"> <li>Eliminate the error that has caused the stop and restart the positioning.</li> </ul>	Error location information and system configuration information	At END instruction execution, at instruction execution
3661H to 366CH	Axes 1 to 12 error stop (immediately stop)	<ul style="list-style-type: none"> <li>When pulses were being output or positioning was starting, the PLC stopped the pulse output immediately by the pulse stop command or detection of the all outputs disable flag.</li> </ul>	Continue/stop <sup>*1</sup>	<ul style="list-style-type: none"> <li>Eliminate the error that has caused the stop and restart the positioning.</li> </ul>	Error location information and system configuration information	At END instruction execution, at instruction execution
3671H to 367CH	Axes 1 to 12 positioning table operand error	<ul style="list-style-type: none"> <li>The value of an operand in the table is abnormal. (Other than the positioning address and command speed)</li> </ul>	Continue/stop <sup>*1</sup>	<ul style="list-style-type: none"> <li>Set the correct value to the table.</li> </ul>	Error location information and system configuration information	At interrupt occurrence, at instruction execution
3681H to 368CH	Axes 1 to 12 positioning table shift error (table specification)	<ul style="list-style-type: none"> <li>Tables which cannot be used together were specified for continuous operation.</li> <li>The counterpart axis for the interpolation operation table was specified.</li> </ul>	Continue/stop <sup>*1</sup>	<ul style="list-style-type: none"> <li>Correct the table combination so that the continuous operation can be performed.</li> <li>To drive the interpolation operation, specify the table of the reference axis.</li> </ul>	Error location information and system configuration information	At interrupt occurrence, at instruction execution
3691H to 369CH	Axes 1 to 12 positioning table shift error (table shift)	<ul style="list-style-type: none"> <li>Table shift processing cannot be completed in time because tables shifted too frequently (one or more tables per 10ms).</li> <li>A conditional jump was executed 4 times in a row or tables are not executed 4 times in a row.</li> </ul>	Continue/stop <sup>*1</sup>	<ul style="list-style-type: none"> <li>Set the interval of table shifts to 10 ms or greater.</li> <li>Correct the table combination so that the condition jumps are executed 3 times or less in a row, or tables are not executed 3 times or less in a row.</li> </ul>	Error location information and system configuration information	At interrupt occurrence
36A1H to 36ACH	Axes 1 to 12 interpolation operation error (no counterpart axis)	<ul style="list-style-type: none"> <li>The counterpart axis table for the interpolation operation cannot be found.</li> </ul>	Continue/stop <sup>*1</sup>	<ul style="list-style-type: none"> <li>Set the table of the counterpart axis correctly.</li> </ul>	Error location information and system configuration information	At instruction execution
36B1H to 36BCH	Axes 1 to 12 interpolation operation error (reference/counterpart axis error)	<ul style="list-style-type: none"> <li>Errors such as limits occurred, which stopped pulses in the reference axis or counterpart axis.</li> <li>The reference axis or partner axis is in use.</li> </ul>	Continue/stop <sup>*1</sup>	<ul style="list-style-type: none"> <li>Verify that the reference axis and partner axis are not in use and the stop conditions are not satisfied.</li> </ul>	—	At instruction execution
36F0H	ABS sum error	<ul style="list-style-type: none"> <li>There is a sum check error in ABS data read from servo.</li> </ul>	Continue/stop <sup>*1</sup>	<ul style="list-style-type: none"> <li>Check servo wiring and setting.</li> </ul>	Error location information	At instruction execution
3780H	High-speed comparison table maximum excess error	<ul style="list-style-type: none"> <li>The number of high-speed comparison tables registered is greater than the upper limit.</li> </ul>	Continue/stop <sup>*1</sup>	<ul style="list-style-type: none"> <li>Check the total number of tables in the parameters and tables registered in the comparison match instruction.</li> </ul>	Error location information and system configuration information	At END instruction execution, at instruction execution
3781H	Preset value range outside error	<ul style="list-style-type: none"> <li>The preset value is greater than the ring length set value.</li> </ul>	Continue/stop <sup>*1</sup>	<ul style="list-style-type: none"> <li>Disable the ring length.</li> <li>Set the preset value within the ring length range.</li> </ul>	Error location information and system configuration information	At instruction execution

Error code	Error name	Error details and cause	Stop/continue	Action	Detailed information	Diagnostic timing
3A00H	Incompatible function in use error	• A CPU module with a serial No. incompatible with the function was used.	Stop	• Use a CPU module with a serial No. compatible with the function. (Refer to  Page 966 Added and Enhanced Functions.)	Parameter information	At power-on, at function use
3A10H	Memory error	• A memory error was detected.	Continue	• Take measures to reduce noise. • Reset the CPU module, and then execute it again. If the same error is displayed again, there may be a hardware failure in the CPU module. Consult your local Mitsubishi Electric representative.	—	At END instruction execution
3C00H	Hardware failure	• A hardware failure was detected.	Stop	• Reset the CPU module and perform RUN. If the same error appears, the hardware of the CPU module may be malfunctioning. Consult your local Mitsubishi Electric representative.	—	At power-on, at RESET
3C02H	Hardware failure	• A hardware failure was detected.	Stop	• Reset the CPU module and perform RUN. If the same error appears, the hardware of the CPU module may be malfunctioning. Consult your local Mitsubishi Electric representative.	System configuration information	At power-on, at RESET
3C03H	Hardware failure	• A hardware failure was detected.	Stop	• Reset the CPU module and perform RUN. If the same error appears, the hardware of the CPU module may be malfunctioning. Consult your local Mitsubishi Electric representative.	System configuration information	At power-on, at RESET
3C0FH	Hardware failure	• A hardware failure was detected.	Stop	• When an intelligent function module is connected to a CPU module, check that the firmware version of the CPU module is compatible with the intelligent function module, and if not compatible, execute the firmware update. • Reset the CPU module and perform RUN. If the same error appears, the hardware of the CPU module may be malfunctioning. Consult your local Mitsubishi Electric representative.	System configuration information	At power-on, at RESET
3C20H	Memory error	• A memory error was detected.	Stop	• Reset the CPU module and perform RUN. If the same error appears, the hardware of the CPU module may be malfunctioning. Initialize the memory, and if the memory still cannot be recovered, consult your local Mitsubishi Electric representative.	—	At power-on, at RESET
3C22H	Memory error	• A memory error was detected.	Stop	• Reset the CPU module and perform RUN. If the same error appears, the hardware of the CPU module may be malfunctioning. Consult your local Mitsubishi Electric representative.	—	At power-on, at RESET
3C23H	Memory error	• A memory error was detected.	Stop	• The project data or latch data may have errors due to a hardware failure in the CPU module. Initialize the memory. If the memory still cannot be recovered, please consult your local Mitsubishi representative.	—	At power-on, at RESET
3C24H	Memory error	• A memory error was detected.	Stop	• Reset the CPU module and perform RUN. If the same error appears, the hardware of the CPU module may be malfunctioning. Consult your local Mitsubishi Electric representative.	—	At power-on, at RESET
3C25H	Memory error	• A memory error was detected.	Stop	• The project data or latch data may have errors. Initialize the memory and then rewrite the project. If the same error is displayed again, there may be a hardware failure in the CPU module. Consult your local Mitsubishi Electric representative.	—	At power-on, at RESET

Error code	Error name	Error details and cause	Stop/continue	Action	Detailed information	Diagnostic timing
3C2FH	Memory error	• A memory error was detected.	Stop	<ul style="list-style-type: none"> <li>Reset the CPU module and perform RUN.</li> <li>If this occurs after updating the firmware, update the firmware again.</li> <li>If the same error is displayed again, there may be a hardware failure in the CPU module. Consult your local Mitsubishi Electric representative.</li> </ul>	Drive/file information	At power-on, at RESET
3C32H	Memory error	• An error has been detected in the memory.	Stop	<ul style="list-style-type: none"> <li>Reset the CPU module, and run it again. If the same error code is displayed again, possible cause is hardware failure of the CPU module. Please consult your local Mitsubishi representative.</li> </ul>	—	At power-on, at RESET
3E20H	Program execution error	• An error has been detected in the memory.	Stop	<ul style="list-style-type: none"> <li>Reduce the number of steps in the program.</li> </ul>	—	At power-on, at RESET, at STOP → RUN state

\*1 Can be changed by the parameter. (Default: Continue)

\*2 Can be changed by the parameter. (Default: Stop)

\*3 If the error is detected at startup, the operation stops regardless of the parameter setting.

## Error codes of the CPU module (4000H to 4FFFH)

The following table lists the error codes detected by other causes than the self-diagnostics function of the CPU module.

Error code	Error name	Error details and cause	Action
4000H	Common error	<ul style="list-style-type: none"> <li>Serial communication sum check error.</li> </ul>	<ul style="list-style-type: none"> <li>Connect the serial communication cable correctly.</li> <li>Take measures to reduce noise.</li> </ul>
4001H	Common error	<ul style="list-style-type: none"> <li>An unsupported request was executed.</li> </ul>	<ul style="list-style-type: none"> <li>Check the command data of SLMP/MC protocol.</li> <li>Check the CPU module model name selected in the engineering tool.</li> <li>Check the target CPU module model name.</li> </ul>
4002H	Common error	<ul style="list-style-type: none"> <li>An unsupported request was executed.</li> </ul>	<ul style="list-style-type: none"> <li>Check the command data of SLMP/MC protocol.</li> <li>Check the CPU module model name selected in the engineering tool.</li> <li>Use a CPU module with a serial No. compatible with the function. For details, refer to the manual.</li> <li>Execute the request again.</li> <li>If the same error code is displayed again, the possible cause is a hardware failure of the CPU module. Please consult your local Mitsubishi representative.</li> </ul>
4005H	Common error	<ul style="list-style-type: none"> <li>The volume of data handled according to the specified request is too large.</li> </ul>	<ul style="list-style-type: none"> <li>Check the command data of SLMP/MC protocol.</li> </ul>
4006H	Common error	<ul style="list-style-type: none"> <li>Initial communication has failed.</li> <li>Initialization of serial communication has failed.</li> </ul>	<ul style="list-style-type: none"> <li>When using serial communication, check with the external device manufacturer for support conditions.</li> <li>When using serial communication, check the CPU module model name selected in the engineering tool.</li> <li>When using Ethernet communication, shift the communication start timing.</li> </ul>
4010H	CPU module operation error	<ul style="list-style-type: none"> <li>Since the CPU module is running, the request contents cannot be executed.</li> </ul>	<ul style="list-style-type: none"> <li>Execute after setting the CPU module to STOP status.</li> </ul>
4013H	CPU module operation error	<ul style="list-style-type: none"> <li>Since the CPU module is not in a STOP status, the request contents cannot be executed.</li> </ul>	<ul style="list-style-type: none"> <li>Execute after setting the CPU module to STOP status.</li> </ul>
4021H	File related error	<ul style="list-style-type: none"> <li>The specified drive (memory) does not exist or there is an error.</li> </ul>	<ul style="list-style-type: none"> <li>Check the specified drive (memory) status.</li> <li>Back up data in the CPU module, and then initialize the memory.</li> </ul>
4022H	File related error	<ul style="list-style-type: none"> <li>The file with the specified file name or file No. does not exist.</li> </ul>	<ul style="list-style-type: none"> <li>Check the specified file name and file No.</li> </ul>
4025H	File related error	<ul style="list-style-type: none"> <li>The specified file is processing the request from another engineering tool.</li> </ul>	<ul style="list-style-type: none"> <li>Forcibly execute the request. Or execute the request again after processing executed from another engineering tool ends.</li> </ul>
4027H	File related error	<ul style="list-style-type: none"> <li>The specified range is larger than the file size.</li> </ul>	<ul style="list-style-type: none"> <li>Check the specified range and access within that range.</li> </ul>
4029H	File related error	<ul style="list-style-type: none"> <li>The specified file capacity cannot be obtained.</li> </ul>	<ul style="list-style-type: none"> <li>Review the specified file capacity, and execute the request again.</li> </ul>
402CH	File related error	<ul style="list-style-type: none"> <li>The requested operation cannot be executed currently.</li> </ul>	<ul style="list-style-type: none"> <li>Execute again after a while.</li> </ul>
4030H	Device specification error	<ul style="list-style-type: none"> <li>The specified device name cannot be handled.</li> <li>■When CPU Module Logging Configuration Tool is used</li> <li>The data logging specifying a device that is not supported was started.</li> </ul>	<ul style="list-style-type: none"> <li>Check the specified device name.</li> </ul>
4031H	Device specification error	<ul style="list-style-type: none"> <li>The specified device No. is outside the range.</li> <li>The CPU module cannot handle the specified device.</li> <li>■When CPU Module Logging Configuration Tool is used</li> <li>The data logging specifying a device number that does not exist was started.</li> </ul>	<ul style="list-style-type: none"> <li>Check the specified device No.</li> <li>Check the device assignment of the CPU module.</li> <li>Check the specified device name.</li> </ul>
4032H	Device specification error	<ul style="list-style-type: none"> <li>The device modification was incorrectly specified. Or, the unusable device (TS, TC, SS, SC, CS, or CC) was specified in any of the following SLMP/MC protocol commands; Read random, Write random (in units of words), Entry monitor device, or Execute monitor.</li> <li>■When CPU Module Logging Configuration Tool is used</li> <li>The data logging specifying a device modification that is not supported was started.</li> </ul>	<ul style="list-style-type: none"> <li>Check the device modification method.</li> <li>Check the specified device name.</li> </ul>

Error code	Error name	Error details and cause	Action
4034H	Device specification error	<ul style="list-style-type: none"> <li>The dedicated instruction cannot be executed since the completion device for the dedicated instruction does not turn on.</li> </ul>	<ul style="list-style-type: none"> <li>Since the completion device for the SREAD or SWRITE instruction does not turn on in the CPU module on the target station, execute the instruction again after setting the operating status of the CPU module on the target station to the RUN status.</li> </ul>
4040H	Intelligent function module specification error	<ul style="list-style-type: none"> <li>The request contents cannot be executed in the specified intelligent function module.</li> </ul>	<ul style="list-style-type: none"> <li>Check whether the specified module is the intelligent function module having the buffer memory.</li> </ul>
4041H	Intelligent function module specification error	<ul style="list-style-type: none"> <li>The access range exceeds the buffer memory range of the specified intelligent function module.</li> </ul>	<ul style="list-style-type: none"> <li>Check the start address and access number of points and access within the range that exists in the intelligent function module.</li> </ul>
4042H	Intelligent function module specification error	<ul style="list-style-type: none"> <li>The specified intelligent function module cannot be accessed.</li> </ul>	<ul style="list-style-type: none"> <li>Check that the specified intelligent function module is operating normally.</li> <li>Check the specified module for a hardware fault.</li> </ul>
4043H	Intelligent function module specification error	<ul style="list-style-type: none"> <li>The intelligent function module does not exist in the specified position.</li> <li>■When CPU Module Logging Configuration Tool is used</li> <li>The data logging specifying a device that does not exist or cannot be accessed was started.</li> </ul>	<ul style="list-style-type: none"> <li>Check the I/O number of the specified intelligent function module.</li> </ul>
4053H	Protect error	<ul style="list-style-type: none"> <li>An error occurred when writing data to the specified drive (memory).</li> </ul>	<ul style="list-style-type: none"> <li>Check the specified drive (memory). Or, write data again after changing the corresponding drive (memory).</li> </ul>
4060H	Online registration error	<ul style="list-style-type: none"> <li>The online debug function and the data logging function are being executed with another engineering tool.</li> <li>■When CPU Module Logging Configuration Tool is used</li> <li>An attempt was made to write or delete data logging settings or to execute data logging to the setting registered by another request source.</li> </ul>	<ul style="list-style-type: none"> <li>Finish the operation of the other engineering tool and then execute the function again.</li> <li>If the operation of the other engineering tool is on hold, resume and finish the operation of the other engineering tool, and then execute the function again.</li> </ul>
4061H	Online registration error	<ul style="list-style-type: none"> <li>Settings for the online debug function (such as online change) are incorrect.</li> </ul>	<ul style="list-style-type: none"> <li>Register an online debug function (external input/output forced on/off function), and then execute the function again.</li> <li>Execute the function again after checking the communication route such as the communication cable.</li> </ul>
4064H	Online registration error	<ul style="list-style-type: none"> <li>The specified contents of the online debug function (such as the online program change), data logging function, memory dump function, or real-time monitor function are incorrect.</li> <li>■When CPU Module Logging Configuration Tool is used</li> <li>The trigger logging was started in a state that the trigger condition has already been satisfied.</li> <li>The logging was started in a state that the condition of the file switching timing condition specification has already been satisfied.</li> </ul>	<ul style="list-style-type: none"> <li>Check the set data of the online debug function (such as the online program change), data logging function, memory dump function, and real-time monitor function.</li> <li>Execute again after checking the communication route such as the communication cable.</li> <li>■When CPU Module Logging Configuration Tool is used</li> <li>Clear the satisfied trigger condition, and execute the trigger logging again.</li> <li>Clear the satisfied condition of the file switching timing condition specification, and execute the logging again.</li> </ul>
4068H	Online registration error	<ul style="list-style-type: none"> <li>Operation is disabled because it is being performed with another engineering tool.</li> </ul>	<ul style="list-style-type: none"> <li>Execute the request again after processing of the function executed from the other engineering tool ends.</li> </ul>
4080H	Other errors	<ul style="list-style-type: none"> <li>Request data error.</li> <li>■When CPU Module Logging Configuration Tool is used</li> <li>Request or setting data error</li> </ul>	<ul style="list-style-type: none"> <li>Check the request data that has been specified.</li> <li>■When CPU Module Logging Configuration Tool is used</li> <li>Check the specified data, and write it to the CPU module again.</li> </ul>
4081H	Other errors	<ul style="list-style-type: none"> <li>The search target data cannot be detected.</li> </ul>	<ul style="list-style-type: none"> <li>Check the data to be searched.</li> </ul>
408BH	Other errors	<ul style="list-style-type: none"> <li>The remote request cannot be executed.</li> </ul>	<ul style="list-style-type: none"> <li>Reexecute after the CPU module is in a status where the remote request can be executed.</li> <li>For remote operation, set the parameter to "Enable remote reset".</li> </ul>
40A0H	SFC device specification error	<ul style="list-style-type: none"> <li>A block No. outside the range was specified.</li> </ul>	<ul style="list-style-type: none"> <li>Check and correct the setting.</li> </ul>
40A1H	SFC device specification error	<ul style="list-style-type: none"> <li>The number of blocks exceeds the range.</li> </ul>	<ul style="list-style-type: none"> <li>Check and correct the set number.</li> </ul>
40A7H	SFC device specification error	<ul style="list-style-type: none"> <li>A block No. that does not exist in the 0 to 31 range was specified.</li> </ul>	<ul style="list-style-type: none"> <li>Check and correct the setting.</li> </ul>
40A8H	SFC device specification error	<ul style="list-style-type: none"> <li>A step No. that does not exist in the 0 to 511 range was specified.</li> </ul>	<ul style="list-style-type: none"> <li>Check and correct the setting.</li> </ul>
40B0H	SFC file related error	<ul style="list-style-type: none"> <li>The drive (memory) specified with the SFC program file operation is incorrect.</li> </ul>	<ul style="list-style-type: none"> <li>Check and correct the setting.</li> </ul>

Error code	Error name	Error details and cause	Action
40B1H	SFC file related error	<ul style="list-style-type: none"> <li>The SFC program specified with the SFC program file operation does not exist.</li> </ul>	<ul style="list-style-type: none"> <li>Check and correct the specified file name.</li> </ul>
40B2H	SFC file related error	<ul style="list-style-type: none"> <li>The program specified with the SFC program file operation is not an SFC program.</li> </ul>	<ul style="list-style-type: none"> <li>Check and correct the specified file name.</li> </ul>
40B5H	SFC file related error	<ul style="list-style-type: none"> <li>The number of SFC steps after changing the program exceeds the maximum number.</li> </ul>	<ul style="list-style-type: none"> <li>Reduce the number of SFC steps to be added by online change.</li> </ul>
40B6H	SFC file related error	<ul style="list-style-type: none"> <li>The specified block does not exist.</li> </ul>	<ul style="list-style-type: none"> <li>Read from the programmable controller to make the programs of the engineering tool and the CPU module the same, and then execute the online change again.</li> </ul>
40B9H	SFC file related error	<ul style="list-style-type: none"> <li>The SFC program after change is incorrect.</li> </ul>	<ul style="list-style-type: none"> <li>Execute again after checking the communication route such as the communication cable.</li> </ul>
40BBH	SFC file related error	<ul style="list-style-type: none"> <li>Online change is not possible immediately after writing to the programmable controller or because a program execution error has occurred.</li> </ul>	<ul style="list-style-type: none"> <li>After STOP changes to RUN, execute online change (inactive SFC block).</li> <li>Execute online change (SFC block) in a state where a program execution error does not occur.</li> </ul>
40BEH	SFC file related error	<ul style="list-style-type: none"> <li>Online change is not possible because the target includes active (holding) steps.</li> </ul>	<ul style="list-style-type: none"> <li>Do not include active (holding) steps.</li> <li>Make any active (holding) step inactive.</li> </ul>
4105H	Any other error	<ul style="list-style-type: none"> <li>Hardware failure of the CPU module internal memory.</li> </ul>	<ul style="list-style-type: none"> <li>The possible cause is a hardware failure of the CPU module. Please consult your local Mitsubishi representative.</li> </ul>
4121H	File related error	<ul style="list-style-type: none"> <li>The specified drive (memory) or file does not exist.</li> </ul>	<ul style="list-style-type: none"> <li>Execute again after checking the specified drive (memory) or file.</li> </ul>
4122H	File related error	<ul style="list-style-type: none"> <li>The specified drive (memory) or file does not exist.</li> </ul>	<ul style="list-style-type: none"> <li>Execute again after checking the specified drive (memory) or file.</li> </ul>
4123H	File related error	<ul style="list-style-type: none"> <li>The specified drive (memory) is abnormal.</li> <li>■When CPU Module Logging Configuration Tool is used</li> <li>The data logging was started to the memory having an error.</li> </ul>	<ul style="list-style-type: none"> <li>Initialize the memory, and restore the drive (memory) to its normal state.</li> </ul>
4125H	File related error	<ul style="list-style-type: none"> <li>The specified drive (memory) or file is performing processing.</li> </ul>	<ul style="list-style-type: none"> <li>Execute again after a while.</li> </ul>
4126H	File related error	<ul style="list-style-type: none"> <li>The specified drive (memory) or file is performing processing.</li> </ul>	<ul style="list-style-type: none"> <li>Execute again after a while.</li> </ul>
4127H	File related error	<ul style="list-style-type: none"> <li>File password mismatch.</li> </ul>	<ul style="list-style-type: none"> <li>Execute again after checking the file password.</li> </ul>
4135H	File related error	<ul style="list-style-type: none"> <li>The date/time data of the engineering tool (personal computer) is out of range.</li> </ul>	<ul style="list-style-type: none"> <li>Execute again after checking the clock setting of the engineering tool (personal computer).</li> </ul>
4136H	File related error	<ul style="list-style-type: none"> <li>The specified file already exists.</li> </ul>	<ul style="list-style-type: none"> <li>Execute again after checking the specified file name.</li> </ul>
4139H	File related error	<ul style="list-style-type: none"> <li>The size of the specified file has exceeded that of the existing file.</li> </ul>	<ul style="list-style-type: none"> <li>Execute again after checking the size of the specified file.</li> </ul>
413AH	File related error	<ul style="list-style-type: none"> <li>The specified file has exceeded the already existing file size.</li> </ul>	<ul style="list-style-type: none"> <li>Execute again after checking the size of the specified file.</li> </ul>
413BH	File related error	<ul style="list-style-type: none"> <li>The same file was simultaneously accessed from different engineering tools.</li> <li>■When CPU Module Logging Configuration Tool is used</li> <li>An operation was performed to a file being accessed.</li> </ul>	<ul style="list-style-type: none"> <li>Execute again after a while.</li> </ul>
413EH	File related error	<ul style="list-style-type: none"> <li>Operation is disabled for the specified drive (memory).</li> </ul>	<ul style="list-style-type: none"> <li>Execute again after changing the target drive (memory).</li> </ul>
4160H	Online registration error	<ul style="list-style-type: none"> <li>The registered number of I/O devices of the forced on/off target exceeded the maximum.</li> </ul>	<ul style="list-style-type: none"> <li>Cancel the registration of I/O devices of the forced on/off target that is not used.</li> </ul>
4166H	Online registration error	<ul style="list-style-type: none"> <li>The operation cannot be performed because an online change is being executed from the same activation source.</li> </ul>	<ul style="list-style-type: none"> <li>An online change cannot be executed because the previous online change failed and remains unprocessed due to a reason such as a communication failure during execution. Execute the new online change forcibly.</li> </ul>



Error code	Error name	Error details and cause	Action
4181H	CPU module built-in Ethernet port error	<ul style="list-style-type: none"> <li>• Transmission to the receiving modules is unsuccessful.</li> </ul>	<ul style="list-style-type: none"> <li>• Check the external device operation.</li> <li>• Check the status of the lines, such as cables, hubs and routes, connected to receiving modules.</li> <li>• Some line packets may be engaged. Retry to communicate a little while later.</li> <li>• The receiving module may have no free space in receive area (TCP window size is small). Check whether the receiving module processes receive data, or whether the CPU module does not send unnecessary data.</li> <li>• Check whether the settings of the subnet mask pattern and the default router IP address of the CPU module and the receiving modules are correct, or whether the class of the IP address is correct.</li> </ul>
4183H	CPU module built-in Ethernet port error	<ul style="list-style-type: none"> <li>• Communication with receiving modules was interrupted.</li> </ul>	<ul style="list-style-type: none"> <li>• Check the external device operation.</li> <li>• Check the status of the lines such as cables, hubs and routes connected to receiving modules.</li> <li>• Error may be generated when connection is forcibly canceled during communication. In that case, there is no issue, so clear the error.</li> </ul>
419AH	CPU module built-in Ethernet port error	<ul style="list-style-type: none"> <li>• A system error or setting data error in the OS (Malfunctions caused by noise and others and hardware failure are the possible causes.)</li> </ul>	<ul style="list-style-type: none"> <li>• If the same error is displayed again after checking, there may be a hardware failure in the CPU module.</li> </ul>
419EH	CPU module built-in Ethernet port error	<ul style="list-style-type: none"> <li>• Connection to the module was unsuccessful or interrupted.</li> </ul>	<ul style="list-style-type: none"> <li>• Check the external device operation.</li> <li>• Check the status of the lines such as cables, hubs and routes connected to receiving modules.</li> <li>• Retry to connect a little while later, if the error occurred in communication.</li> </ul>
41C5H	File related error	<ul style="list-style-type: none"> <li>• The specified file does not exist.</li> <li>■When CPU Module Logging Configuration Tool is used</li> <li>• When an attempt was made to re-register the data logging with the previous settings, the corresponding file did not exist.</li> </ul>	<ul style="list-style-type: none"> <li>• Execute again after checking the file.</li> </ul>
41C8H	File related error	<ul style="list-style-type: none"> <li>• The size of the specified file has exceeded that of the existing file.</li> </ul>	<ul style="list-style-type: none"> <li>• Execute again after checking the size of the specified file.</li> <li>• If the error recurs after re-execution, the file information data may be corrupted.</li> <li>• Back up data in the CPU module, and then initialize the memory.</li> </ul>
41CCH	File related error	<ul style="list-style-type: none"> <li>• The specified file does not exist. Or, the specified subdirectory does not exist.</li> <li>■When CPU Module Logging Configuration Tool is used</li> <li>• The data logging was started in a state that sub-folders for storing data logging files (or folders) cannot be created or accessed. Or, sub-folders cannot be created or accessed while the data logging is being performed or the logged data is being saved.</li> </ul>	<ul style="list-style-type: none"> <li>• Execute again after checking the name of the file and subdirectory.</li> </ul>
41CDH	File related error	<ul style="list-style-type: none"> <li>• An access to the file is prohibited in the system.</li> <li>■When CPU Module Logging Configuration Tool is used</li> <li>• The data logging was started in a state that files (or folders) cannot be created or accessed because a file (or folder) with the same name exists. Or, files (folders) cannot be created or accessed while the data logging is being performed or the logged data is being saved.</li> </ul>	<ul style="list-style-type: none"> <li>• Do not access the specified file (folder).</li> <li>• Check the file (folder), and execute the function again.</li> </ul>
41D0H	File related error	<ul style="list-style-type: none"> <li>• The specified drive (memory) has no free space. Or, the number of files in the directory of the specified drive (memory) has exceeded the maximum.</li> </ul>	<ul style="list-style-type: none"> <li>• Execute again after increasing the free space of the drive (memory).</li> <li>• Delete files in the drive (memory), and execute the function again.</li> </ul>
41D8H	File related error	<ul style="list-style-type: none"> <li>• The specified file is being accessed.</li> </ul>	<ul style="list-style-type: none"> <li>• Execute again after a while.</li> </ul>
41DFH	File related error	<ul style="list-style-type: none"> <li>• The specified drive (memory) is write-protected.</li> </ul>	<ul style="list-style-type: none"> <li>• Execute again after canceling the write protect of the specified drive (memory).</li> </ul>
41E4H	File related error	<ul style="list-style-type: none"> <li>• Access to the SD memory card has failed.</li> </ul>	<ul style="list-style-type: none"> <li>• Execute the operation again after checking that the SD memory card has been inserted.</li> <li>• Execute the operation again after replacing the SD memory card.</li> <li>• Back up data, and then initialize the PC memory.</li> </ul>
41EBH	File related error	<ul style="list-style-type: none"> <li>• The file name path is too long.</li> </ul>	<ul style="list-style-type: none"> <li>• Execute again after shortening the file name path.</li> </ul>



Error code	Error name	Error details and cause	Action
41FBH	Online module change related error	<ul style="list-style-type: none"> <li>The specified file is already being processed by the engineering tool.</li> </ul>	<ul style="list-style-type: none"> <li>Execute again after the currently performed operation is completed.</li> </ul>
41FEH	File related error	<ul style="list-style-type: none"> <li>The SD memory card has not been inserted.</li> <li>The SD memory card is disabled.</li> <li>The SD memory card turned to disable status by SM606 (SD memory card forcibly disable command).</li> <li>■When CPU Module Logging Configuration Tool is used</li> <li>The data logging was started when the CPU module is in the following state: no SD memory card is inserted; the CARD LED is not on; or the SD memory card is forcibly disabled.</li> </ul>	<ul style="list-style-type: none"> <li>Insert the SD memory card.</li> <li>Remove the SD memory card, and insert it again.</li> <li>Cancel the SD memory card forced disable instruction.</li> <li>If the SD memory card module is not mounted, power off the CPU module, mount the SD memory card module, and power on the CPU module again.</li> </ul>
4269H	Any other error	<ul style="list-style-type: none"> <li>The remote RUN (function) cannot be executed.</li> </ul>	<ul style="list-style-type: none"> <li>Execute the function again after a while.</li> </ul>
4270H	Data logging function error	<ul style="list-style-type: none"> <li>Data logging function is being performed (data logging status: Being executed, Saving in progress, End, Pause, Error status) to another memory.</li> </ul>	<ul style="list-style-type: none"> <li>Register data logging to the memory where the data logging is being performed. Or, stop the data logging being performed and register again.</li> <li>■When CPU Module Logging Configuration Tool is used</li> <li>Start the data logging to the memory where the data logging is being performed. Or, stop the data logging being performed, and start the data logging.</li> </ul>
4271H	Data logging function error	<ul style="list-style-type: none"> <li>The specified data logging is already being performed (data logging status: Being executed, Saving in progress, End, Pause, Error status).</li> </ul>	<ul style="list-style-type: none"> <li>Stop the data logging. Or, write, delete, or register data logging to the setting number where no data logging is being performed.</li> </ul>
4276H	Data logging function error	<ul style="list-style-type: none"> <li>The specified command cannot be executed because the data logging function is being executed (data logging status: Being executed, Saving in progress, End, Pause, Error status).</li> </ul>	<ul style="list-style-type: none"> <li>Stop the data logging, and then execute the function.</li> </ul>
4277H	Data logging function error	<ul style="list-style-type: none"> <li>The number of saved files exceeded the specified number.</li> <li>■When CPU Module Logging Configuration Tool is used</li> <li>The data logging was started in a state where the number of saved files has exceeded the specified number. (The operation when the number of saved files exceeded is set to "Stop".) Or, the data logging was started in a state where the number of saved files has exceeded the specified number. (The operation when the number of saved files exceeded is set to "Overwrite".)</li> </ul>	<ul style="list-style-type: none"> <li>The number of files saved in the storage destination memory has exceeded the setting value. Delete files, or change the storage destination and then register.</li> <li>■When CPU Module Logging Configuration Tool is used</li> <li>The number of files saved in the storage destination memory has exceeded the setting value. Delete files or change the storage destination, and then start the data logging.</li> </ul>
4278H	Data logging function error	<ul style="list-style-type: none"> <li>The data logging was started in a state where the saved file number has reached its maximum, FFFFFFFF. Or, the number reached to the maximum during the execution.</li> <li>■When CPU Module Logging Configuration Tool is used</li> <li>The data logging was started in a state where the saved file number has reached its maximum, FFFFFFFF. Or, the number reached to the maximum during the execution.</li> </ul>	<ul style="list-style-type: none"> <li>The saved file number in the storage target memory has reached its maximum, FFFFFFFF. Delete files, or change the storage destination and then register.</li> <li>■When CPU Module Logging Configuration Tool is used</li> <li>The saved file number in the storage target memory has reached its maximum, FFFFFFFF. Delete files or change the storage target memory, and then perform the data logging.</li> </ul>
4279H	Data logging function error	<ul style="list-style-type: none"> <li>Data logging started with the size of the data logging file exceeding the file size set in the storage file switching condition. Or the file size exceeded the set file size while data was saved during execution.</li> </ul>	<ul style="list-style-type: none"> <li>Set a larger size in the storage file switching condition.</li> <li>Reduce output information and reduce the header size. (Basically, this occurs when "Output device comment" is selected for "Data name row" in "Data column" and many double quotations are used in the device data.)</li> </ul>
427BH	Data logging function error	<ul style="list-style-type: none"> <li>The data logging function with the same file storage destination is being performed (data logging status: Being executed, Saving in progress, End, Pause, Error status).</li> <li>■When CPU Module Logging Configuration Tool is used</li> <li>The data logging with the same file storage destination is being performed (data logging status: RUN waiting (no collection), Start waiting (no collection), Condition waiting (no collection), Pause, Collecting, Trigger waiting (collecting before trigger), Collecting after trigger, or Saving the logging data).</li> </ul>	<ul style="list-style-type: none"> <li>Stop the data logging destined for the same storage, and then register. Or, change the storage destination of the file, and then register.</li> <li>■When CPU Module Logging Configuration Tool is used</li> <li>Stop the data logging destined for the same storage, and then perform another data logging. Or, change the storage destination of the file, and then register.</li> </ul>
4280H	Data logging function error	<ul style="list-style-type: none"> <li>A file transfer test was executed from another CPU Module Logging Configuration Tool during execution of a file transfer test.</li> </ul>	<ul style="list-style-type: none"> <li>Execute the file transfer test again after the ongoing test is completed.</li> </ul>
4281H	Data logging function error	<ul style="list-style-type: none"> <li>An attempt was made to register the logging setting for a different PC series.</li> </ul>	<ul style="list-style-type: none"> <li>Register the logging setting for the same PC series.</li> </ul>
4282H	Data logging function error	<ul style="list-style-type: none"> <li>The registration was performed with the internal buffer capacity set to 0.</li> </ul>	<ul style="list-style-type: none"> <li>Check and correct the internal buffer capacity setting.</li> </ul>

Error code	Error name	Error details and cause	Action
4283H	Data logging function error	<ul style="list-style-type: none"> <li>An attempt was made to register trigger logging in a state that the specified number of records before trigger has exceeded the number of records that can be collected within the internal buffer capacity</li> </ul>	<ul style="list-style-type: none"> <li>Check and correct the internal buffer capacity setting.</li> <li>Reduce the number of records before trigger.</li> </ul>
4285H	Data logging function error	<ul style="list-style-type: none"> <li>A non-executable function has been executed during collection or save in memory dump.</li> </ul>	<ul style="list-style-type: none"> <li>Execute the function again after the completion of save in memory dump.</li> </ul>
4292H	Debug related function error	<ul style="list-style-type: none"> <li>Real-time monitor does not begin during the execution of real-time monitor.</li> </ul>	<ul style="list-style-type: none"> <li>Start real-time monitor after the stopping of the real-time monitor is being executed.</li> </ul>
4293H	Debug related function error	<ul style="list-style-type: none"> <li>Execution fails because the internal buffer exceeds its maximum capacity.</li> </ul>	<ul style="list-style-type: none"> <li>Check and correct the settings of internal buffer capacity, and then try again.</li> </ul>
433CH	Maintenance and inspection error	<ul style="list-style-type: none"> <li>The error was not cleared.</li> </ul>	<ul style="list-style-type: none"> <li>Execute the request again.</li> </ul>
4401H	Security function error	<ul style="list-style-type: none"> <li>Read password authentication has failed when required.</li> <li>The file password format is incorrect.</li> </ul>	<ul style="list-style-type: none"> <li>Set the correct read password and perform password authentication.</li> <li>Access the file with the correct method.</li> </ul>
4402H	Security function error	<ul style="list-style-type: none"> <li>Write password authentication has failed when required.</li> <li>The file password format is incorrect.</li> </ul>	<ul style="list-style-type: none"> <li>Set the correct write password and perform password authentication.</li> <li>Access the file with the correct method.</li> </ul>
4403H	Security function error	<ul style="list-style-type: none"> <li>Both passwords for reading and for writing do not match the previous passwords when trying to change, authenticate, or delete password.</li> </ul>	<ul style="list-style-type: none"> <li>Set correct passwords for both reading and writing, and perform password authentication.</li> </ul>
4408H	Security function error	<ul style="list-style-type: none"> <li>File password authentication has failed when required.</li> </ul>	<ul style="list-style-type: none"> <li>Set the correct password and perform password authentication again.</li> </ul>
440DH	Security function error	<ul style="list-style-type: none"> <li>File password authentication failed when access was required.</li> </ul>	<ul style="list-style-type: none"> <li>Set a correct password and perform password authentication again.</li> </ul>
440EH	Security function error	<ul style="list-style-type: none"> <li>The security function was activated and password authentication cannot be performed.</li> <li>Register/cancel file password was attempted on a file set to permanent PLC lock.</li> </ul>	<ul style="list-style-type: none"> <li>Set a correct password and perform password authentication again after a certain period of time.</li> <li>It is necessary to delete the whole project to delete the file set to permanent PLC lock.</li> </ul>
440FH	Security function error	<ul style="list-style-type: none"> <li>An operation was performed to the firmware update prohibited file with a file password set.</li> </ul>	<ul style="list-style-type: none"> <li>Disable the file password setting.</li> </ul>
4412H	Security function error	<ul style="list-style-type: none"> <li>The security key cannot be registered to the CPU module due to failure of the internal memory where the security key is registered. Or, the security key of the CPU module cannot be deleted.</li> </ul>	<ul style="list-style-type: none"> <li>Hardware failure of the CPU module. Replace the CPU module.</li> </ul>
4416H	Security function error	<ul style="list-style-type: none"> <li>Since the CPU module is in lock or unlock operation, the requested processing cannot be performed.</li> </ul>	<ul style="list-style-type: none"> <li>Request the processing after the lock or unlock operation ends.</li> </ul>
4422H	Security function error	<ul style="list-style-type: none"> <li>The access target CPU module does not support the security key information stored in the engineering tool.</li> </ul>	<ul style="list-style-type: none"> <li>Change the security key information version of the engineering tool in accordance with the version supported by the target CPU module.</li> </ul>
4423H	Security function error	<ul style="list-style-type: none"> <li>The specified target of security key operation is inaccurate.</li> </ul>	<ul style="list-style-type: none"> <li>Set target of security key operation to CPU module.</li> </ul>
480CH	iQ Sensor Solution related error	<ul style="list-style-type: none"> <li>The specified command cannot be executed because the automatic detection of connected device function of iQ Sensor Solution is being executed.</li> </ul>	<ul style="list-style-type: none"> <li>Execute the command again after the automatic detection processing ends.</li> </ul>
480DH	iQ Sensor Solution related error	<ul style="list-style-type: none"> <li>The specified command cannot be executed because the communication setting reflection function of iQ Sensor Solution is being executed.</li> </ul>	<ul style="list-style-type: none"> <li>Execute the command again after the communication setting reflection processing ends.</li> </ul>
480EH	iQ Sensor Solution related error	<ul style="list-style-type: none"> <li>The specified command cannot be executed because the monitor function of iQ Sensor Solution is being executed.</li> <li>The specified command cannot be executed because the sensor parameter read/write function of iQ Sensor Solution is being executed.</li> </ul>	<ul style="list-style-type: none"> <li>Execute the function again after a while.</li> <li>Execute the command again after the sensor parameter read/write processing ends.</li> </ul>

Error code	Error name	Error details and cause	Action
4A00H	Network error	<ul style="list-style-type: none"> <li>Access to the specified station cannot be made since the routing parameters are not set to the start source CPU module and/or relay CPU module.</li> <li>For routing via a multiple CPU system, the control CPU module of the network module for data routing or the CPU module for data routing has not started.</li> <li>During configuration of a redundant system, communication via the network module to other station is attempted when the system A/B is not determined.</li> <li>The third byte of the IP address (network number) specified by the IP communication test and the third byte of the IP address of the CPU module that starts the IP communication test are duplicated.</li> </ul>	<ul style="list-style-type: none"> <li>Set to the related stations the routing parameters for access to the specified station.</li> <li>Retry after a while. Or, start communication after checking that the system for data routing has started.</li> <li>To configure a redundant system, attach a tracking cable and normally startup the system A/B, then execute communication again.</li> <li>Do not duplicate the third byte of the IP address (network number) specified by the IP communication test and the third byte of the IP address of the CPU module that starts the IP communication test.</li> </ul>
4A01H	Network error	<ul style="list-style-type: none"> <li>The network of the number set to the routing parameters does not exist.</li> <li>The specified CPU module cannot be communicated through the network that is not supported by the CPU module.</li> <li>A communication path which is not compatible with the specified CPU module is specified.</li> </ul>	<ul style="list-style-type: none"> <li>Check and correct the routing parameters set to the related stations.</li> <li>Set communication through the network that is supported by the specified CPU module.</li> </ul>
4A02H	Network error	<ul style="list-style-type: none"> <li>Access to the specified station cannot be made.</li> </ul>	<ul style="list-style-type: none"> <li>Check the network module/link module for error, or check that the modules are not in offline.</li> </ul>
4B00H	Target module error	<ul style="list-style-type: none"> <li>An error occurred in the access destination or relay station.</li> <li>The specified transfer setup (request destination module number) is invalid.</li> </ul>	<ul style="list-style-type: none"> <li>Take corrective action after checking the error that occurred at the specified access destination or the relay station to the accessed station.</li> <li>Check the transfer setup (request destination module number or PLC number) in the request data of SLMP/MC protocol.</li> <li>Check the stop error, and take action.</li> </ul>
4B02H	Target module error	<ul style="list-style-type: none"> <li>The request is not addressed to the CPU module.</li> </ul>	<ul style="list-style-type: none"> <li>Perform operation to a module that can execute the specified function.</li> </ul>
4B03H	Target module error	<ul style="list-style-type: none"> <li>The specified route is not supported by the specified CPU module firmware version.</li> <li>The communication target CPU module is not mounted.</li> </ul>	<ul style="list-style-type: none"> <li>Check whether the specified route is supported or not.</li> <li>Check the mounting status of the CPU module.</li> <li>Check the stop error, and take action.</li> </ul>
4C00H	Data logging function error	<ul style="list-style-type: none"> <li>There is not enough free space for storing.</li> </ul>	<ul style="list-style-type: none"> <li>Increase the free space, and create the result file again.</li> </ul>
4C01H	Data logging function error	<ul style="list-style-type: none"> <li>The result file cannot be written to the target memory because the SD memory card is write-protected or the folder/file structure is incorrect.</li> </ul>	<ul style="list-style-type: none"> <li>Unlock the write protect switch of the SD memory card, and write the result file again.</li> <li>Check that the SD memory card is not damaged.</li> <li>Check that the file/folder to be used in the SD memory card has not been deleted.</li> </ul>
4C02H	Data logging function error	<ul style="list-style-type: none"> <li>The SD memory card was removed while the data logging function was being executed (data logging status: RUN waiting (no collection), Collecting, Trigger waiting (collecting before trigger), Collecting after trigger, or Saving the logging data).</li> </ul>	<ul style="list-style-type: none"> <li>Insert the SD memory card, and execute the function again.</li> </ul>
4C03H	Data logging function error	<ul style="list-style-type: none"> <li>The number of files in the root directory and subdirectory in the target memory exceeded the limit.</li> </ul>	<ul style="list-style-type: none"> <li>Increase the free space of the drive (memory), and execute the function again.</li> <li>Delete files in the drive (memory), and execute the function again.</li> </ul>
4C04H	Data logging function error	<ul style="list-style-type: none"> <li>During auto logging, a data logging was not registered due to a registration failure of the data logging with another setting number.</li> </ul>	<ul style="list-style-type: none"> <li>Clear the error, and register auto logging.</li> </ul>
4C05H	Data logging function error	<ul style="list-style-type: none"> <li>The online change function was executed while the data logging function specifying the step number as a sampling or trigger condition was being executed (data logging status: RUN waiting (no collection), Condition waiting (no collection), Start waiting (no collection), Pause, Trigger-wait not collected, Collecting, Trigger waiting (collecting before trigger), Collecting after trigger, or Saving the logging data).</li> </ul>	<ul style="list-style-type: none"> <li>Do not execute the online change function while the data logging function specifying the step number is being executed (data logging status: RUN waiting (no collection), Condition waiting (no collection), Start waiting (no collection), Pause, Collecting, Trigger waiting (collecting before trigger), Collecting after trigger, or Saving the logging data).</li> <li>Stop the data logging function specifying the step number.</li> </ul>
4C06H	Data logging function error	<ul style="list-style-type: none"> <li>System error</li> </ul>	<ul style="list-style-type: none"> <li>Check the specified data, and write it to the CPU module again.</li> </ul>

Error code	Error name	Error details and cause	Action
4C0BH	File transfer error	<ul style="list-style-type: none"> <li>A data logging file that is being transferred is deleted.</li> <li>Reading from (an access to) a data logging file is failed.</li> <li>The specified file does not exist. Or, the specified subdirectory does not exist.</li> </ul>	<ul style="list-style-type: none"> <li>Check and correct the number of files to be saved in the file switching setting.</li> <li>Check if the data logging file is deleted.</li> <li>Check that an SD memory card is inserted.</li> <li>Execute the transfer again after checking the name of the file and subdirectory.</li> </ul>
4C0CH	Data logging function error	<ul style="list-style-type: none"> <li>The data logging file transfer function is executed while the access to the SD memory card is forcibly disabled.</li> <li>The SD memory card is removed during the data logging file transfer function is executed.</li> </ul>	<ul style="list-style-type: none"> <li>Clear the forcibly disabled state of the SD memory card, and execute the function again.</li> <li>Insert the SD memory card, and execute the function again.</li> </ul>
4C0DH	Data logging function error	<ul style="list-style-type: none"> <li>A data logging is attempted to start during a transfer of a result file.</li> </ul>	<ul style="list-style-type: none"> <li>Restart the data logging after the completion of the data logging file transfer function.</li> </ul>
4C0EH	Data logging function error	<ul style="list-style-type: none"> <li>A file transfer is stopped by the data logging file transfer stop request.</li> </ul>	<ul style="list-style-type: none"> <li>Do not send the data logging file transfer stop request.</li> </ul>
4C10H	CPU module backup/restoration function error	<ul style="list-style-type: none"> <li>The maximum allowable capacity is exceeded.</li> <li>The maximum allowable number of files is exceeded.</li> <li>The upper limit of the backup folder number is exceeded.</li> <li>The maximum length (255 characters) of the file path is exceeded.</li> </ul>	<ul style="list-style-type: none"> <li>Increase the free space of the SD memory card and CPU module, and execute the function again.</li> <li>Delete files in the SD memory card and CPU module, and execute the function again.</li> <li>Delete backup data in the SD memory card and CPU module, and execute the function again.</li> <li>Check and correct the folder structure or folder/file names of backup target data, and execute the data backup function again.</li> </ul>
4C11H	CPU module backup/restoration function error	<ul style="list-style-type: none"> <li>An SD memory card is not inserted.</li> <li>The SD memory card is disabled.</li> <li>The SD memory card turned to disable status by SM606 (SD memory card forcibly disable command).</li> </ul>	<ul style="list-style-type: none"> <li>Insert or re-insert an SD memory card, and execute the function again.</li> <li>Slide the SD memory card access control switch to ON (downward).</li> <li>Enable the SD memory card operation, and execute the function again.</li> <li>If the SD memory card module is not mounted, power off the CPU module, mount the SD memory card module, and power on the CPU module again.</li> </ul>
4C12H	CPU module backup/restoration function error	<ul style="list-style-type: none"> <li>Reading/writing of data from/to an SD memory card completed with an error.</li> </ul>	<ul style="list-style-type: none"> <li>Check that an SD memory card is inserted, and execute the function again.</li> <li>Replace the SD memory card, and execute the function again.</li> <li>The backup data may have been corrupted. Execute the data restoration function using another backup data.</li> </ul>
4C13H	CPU module backup/restoration function error	<ul style="list-style-type: none"> <li>Reading/writing of data from/to the CPU built-in memory completed with an error.</li> <li>The backup target files opened in the CPU built-in memory are duplicated.</li> </ul>	<ul style="list-style-type: none"> <li>Back up data in the CPU built-in memory, initialize the memory, and write the data back to the original memory. Then, execute the data backup/restoration function.</li> <li>The possible cause is a hardware failure of the restoration target CPU module. Execute the data restoration function to another CPU module.</li> <li>Execute the function again after a while.</li> </ul>
4C14H	CPU module backup/restoration function error	<ul style="list-style-type: none"> <li>The CPU module data backup/restoration function cannot be executed because a file password is set to the data.</li> <li>Data was restored to the CPU module where the same data with a file password has already been stored.</li> </ul>	<ul style="list-style-type: none"> <li>Delete file passwords, and execute the CPU module data backup/restoration function.</li> </ul>
4C15H	CPU module backup/restoration function error	<ul style="list-style-type: none"> <li>The function that cannot be executed simultaneously with such as the file transfer function (FTP) is being executed.</li> </ul>	<ul style="list-style-type: none"> <li>Execute the function again after a while.</li> </ul>
4C17H	CPU module backup/restoration function error	<ul style="list-style-type: none"> <li>The backed up CPU module and restoration target destination CPU module models were different when restoration was executed.</li> </ul>	<ul style="list-style-type: none"> <li>Execute restoration again with the same CPU module model as the backed up CPU module.</li> </ul>
4C18H	CPU module backup/restoration function error	<ul style="list-style-type: none"> <li>Data was restored while the operating status of the CPU module is in RUN or PAUSE.</li> </ul>	<ul style="list-style-type: none"> <li>Change the operating status of the CPU module to STOP, and execute the function again.</li> </ul>

Error code	Error name	Error details and cause	Action
4C19H	CPU module backup/restoration function error	<ul style="list-style-type: none"> <li>The data restoration function was executed with backup files (\$BKUP_CPU_INF.BSC and BKUP_CPU.BKD) not structured properly.</li> <li>Data (file(s)) is missing in the backup file (\$BKUP_CPU_INF.BSC) in the backup data folder.</li> <li>The data restoration function was executed with a folder where no backup files (\$BKUP_CPU_INF.BSC, BKUP_CPU.BKD, and BKUP_CPU_DEVLAB.BKD) are stored.</li> <li>The backed up CPU module and restoration target destination CPU module models were different when restoration was executed.</li> </ul>	<ul style="list-style-type: none"> <li>The backup data may have been corrupted. Execute the data restoration function using another backup data.</li> <li>Execute restoration again with the same CPU module model as the backed up CPU module.</li> </ul>
4C1AH	CPU module backup/restoration function error	<ul style="list-style-type: none"> <li>A value outside the allowable range was set to the operation mode.</li> <li>A folder with a value that matches the restoration target date folder setting value or number folder setting value does not exist in the SD memory card.</li> <li>The restoration target data setting value is out of range.</li> <li>The restoration target date folder setting value or number folder setting value is out of range.</li> </ul>	<ul style="list-style-type: none"> <li>Check the operation mode setting value, and execute again.</li> <li>Check and correct the restoration target date folder setting value or number folder setting value, and execute the function again.</li> <li>Check and correct the restoration target data setting value, and execute the function again.</li> </ul>
4C1BH	CPU module backup/restoration function error	<ul style="list-style-type: none"> <li>The data restoration function was executed to the CPU module whose status (such as programs, parameters, and file structure) differs from that of when the data backup function was executed.</li> </ul>	<ul style="list-style-type: none"> <li>Match the CPU module status to the one at the time of backup, and execute the function again.</li> <li>Store 0 (All target data) to SD954 (Restoration target data setting) and execute the automatic restoration.</li> </ul>
4C1CH	CPU module backup/restoration function error	<ul style="list-style-type: none"> <li>An SD memory card is not inserted.</li> <li>The SD memory card turned to disable status by SM606 (SD memory card forcibly disable command).</li> <li>The SD memory card is write-protected.</li> </ul>	<ul style="list-style-type: none"> <li>Insert or re-insert an SD memory card, and execute the function again.</li> <li>Enable the SD memory card operation, and execute the function again.</li> <li>Cancel the write protection, and execute the function again.</li> </ul>
4C1EH	CPU module backup/restoration function error	<ul style="list-style-type: none"> <li>When the SFC program specified a continuation start, the status of the SFC program changed during backup execution, such as changing the step active state or establishing transition conditions.</li> </ul>	<ul style="list-style-type: none"> <li>Do not allow the status of the SFC program to change while the backup is in progress, and then re-execute.</li> </ul>
4C1FH	CPU module data backup/restoration function error	<ul style="list-style-type: none"> <li>The specified command cannot be executed because the CPU module data backup/restoration function is being executed.</li> </ul>	<ul style="list-style-type: none"> <li>Execute the command again after the data backup/restoration processing ends.</li> </ul>
4C20H	CPU module backup/restoration function error	<ul style="list-style-type: none"> <li>The data backup/restoration function was executed while the CPU module is in a state where this function cannot be executed.</li> </ul>	<ul style="list-style-type: none"> <li>Check that the CPU module's serial No. is compatible with the backup function (16Y**** or later).</li> <li>Initialize the CPU built-in memory, and execute the data restoration function again.</li> </ul>
4C40H	File transfer function (FTP client) error	<ul style="list-style-type: none"> <li>When files are specified by using wild card characters for the file transfer function instruction, the number of files matched exceeds the upper limit of the transferable number of files.</li> <li>When files are specified by using wild card characters for the file transfer function instruction, no files are matched.</li> </ul>	<ul style="list-style-type: none"> <li>Check and correct the wild card specification.</li> </ul>
4C43H	File transfer function (FTP client) error	<ul style="list-style-type: none"> <li>The number of processing completed files for sending or acquiring FTP client file is mismatched with the total number of processing files.</li> </ul>	<ul style="list-style-type: none"> <li>Execute the function again.</li> </ul>
4C44H	File transfer function (FTP client) error	<ul style="list-style-type: none"> <li>The file transfer function (FTP client) is executed while the backup/restoration function are being executed.</li> </ul>	<ul style="list-style-type: none"> <li>Execute the File transfer function (FTP client) again after the backup/restoration function is completed.</li> </ul>
4D40H	Firmware update function error (Via engineering tool)	<ul style="list-style-type: none"> <li>Access to the flash ROM of the module to be updated has failed.</li> </ul>	<ul style="list-style-type: none"> <li>Perform the firmware update to the target module again.</li> </ul>

Error code	Error name	Error details and cause	Action
4D41H	Firmware update function error (Via engineering tool)	<ul style="list-style-type: none"> <li>• Access to the module to be updated has failed.</li> <li>• The firmware cannot be updated on the target module.</li> <li>• An incorrect firmware update file (a firmware update file not for the module to be updated) has been used.</li> <li>• An invalid firmware update file has been used.</li> </ul>	<ul style="list-style-type: none"> <li>• Check the module to be updated for any hardware failure and perform the firmware update again.</li> <li>• Check that the module to be updated has started up normally and perform the firmware update again.</li> <li>• Check if the firmware can be updated on the target module.</li> <li>• Set the correct firmware update file for the module to be updated in the engineering tool, and perform the firmware update again.</li> <li>• Ensure that the name or contents of the firmware update file is not changed from its original state.</li> </ul>
4D44H	Firmware update function error (Via engineering tool)	<ul style="list-style-type: none"> <li>• A firmware update file of the version that cannot be installed on the module used has been used.</li> </ul>	<ul style="list-style-type: none"> <li>• Use the module with a firmware version that supports the firmware update using the engineering tool.</li> </ul>
4D45H	Firmware update function error (Via engineering tool)	<ul style="list-style-type: none"> <li>• The firmware update is disabled.</li> </ul>	<ul style="list-style-type: none"> <li>• Enable the firmware update and perform the operation again.</li> </ul>
4D46H	Firmware update function error (Via engineering tool)	<ul style="list-style-type: none"> <li>• The engineering tool and the CPU module are connected incorrectly. (The cable connection and/or connection settings in the engineering tool are not correct.)</li> </ul>	<ul style="list-style-type: none"> <li>• Check that the CPU module is connected via USB or built-in Ethernet (Ethernet port direct connection/connection via hub).</li> </ul>
4D47H	Firmware update function error (Via engineering tool)	<ul style="list-style-type: none"> <li>• The operation cannot be performed because the firmware update is being performed.</li> <li>• The operation cannot be performed because the CPU module is not reset after the firmware update.</li> <li>• An error occurred during execution of the previous firmware update.</li> </ul>	<ul style="list-style-type: none"> <li>• After the firmware update completes, perform the operation again.</li> <li>• Manually reset the CPU module and perform the firmware update again.</li> </ul>
4D48H	Firmware update function error (Via engineering tool)	<ul style="list-style-type: none"> <li>• The firmware update cannot be performed due to a CPU module stop error.</li> <li>• The module may be faulty.</li> </ul>	<ul style="list-style-type: none"> <li>• Correct the parameters.</li> <li>• If the same error is displayed again, please consult your local Mitsubishi representative.</li> </ul>
4D49H	Firmware update function error (Via engineering tool)	<ul style="list-style-type: none"> <li>• The CPU module has been powered off or reset during the firmware update processing.</li> <li>• The engineering tool or communication error has occurred during the firmware update processing.</li> </ul>	<ul style="list-style-type: none"> <li>• Update the firmware again.</li> </ul>
4D4AH	Firmware update function error (Via engineering tool)	<ul style="list-style-type: none"> <li>• An invalid firmware update file has been used.</li> </ul>	<ul style="list-style-type: none"> <li>• Ensure that the name or contents of the firmware update file is not changed from its original state.</li> </ul>
4D4DH	Firmware update function error (Via engineering tool)	<ul style="list-style-type: none"> <li>• A firmware data error is detected during the firmware update processing.</li> </ul>	<ul style="list-style-type: none"> <li>• Update the firmware again.</li> </ul>
4D4EH	Firmware update function error (Via engineering tool)	<ul style="list-style-type: none"> <li>• The specified operation cannot be performed because the firmware update is being performed.</li> <li>• A remote operation other than remote RESET was executed.</li> </ul>	<ul style="list-style-type: none"> <li>• Reset the CPU module after the completion of the firmware update and perform the specified operation again.</li> </ul>



## Error codes of errors in PID control via parameter (8100H to 8230H)

The following table lists error codes of errors in the PID control via parameter function.

Error code	Error name	Error details and cause	Stop/continue	Action
8100H	Auto-tuning malfunction	The difference between the maximum and minimum values for the measured value (PV) during auto tuning is too small.	Continue	Multiply the measured value (PV) by "10" so that the variation of the measured value will increase during auto tuning. (If an error occurs, set the measured value (PV) to 32767.)
8101H	Auto-tuning malfunction		Continue	
8102H	Auto-tuning malfunction	The auto tuning time is longer than necessary.	Continue	<p>■For standard PID control</p> <ul style="list-style-type: none"> <li>• Check the value for the upper limit output limiter and correct the value if it is smaller than 100%.</li> <li>• Check the value for the lower limit output limiter and correct the value if it is larger than 0%.</li> </ul> <p>■For heating-cooling PID control</p> <ul style="list-style-type: none"> <li>• Check the value for the heating upper limit output limiter and correct the value if it is smaller than 100%.</li> <li>• Check the value for the cooling upper limit output limiter and correct the value if it is smaller than 100%.</li> </ul> <p>■Common to PID control</p> <ul style="list-style-type: none"> <li>• Due to the influence of the environment, the temperature of the control target may be unable to fall or rise. Stop controlling the adjacent control targets and execute auto tuning for the control target individually.</li> </ul> <p>(If an error occurs, set the value for the upper limit output limiter/lower limit output limiter/heating upper limit output limiter/cooling upper limit output limiter to 32767.)</p>
8103H	Auto-tuning malfunction		Continue	
8110H	Out of parameter setting range	During PID control, a value outside the allowable range was set to the proportional gain (KP) or heating proportional gain (KPh).	Continue	Set a value in the range 0 to 32767 to the proportional gain (KP) or heating proportional gain (KPh). (If an error occurs, set the proportional gain (KP) or heating proportional gain (KPh) to 0.)
8111H	Out of parameter setting range	A value outside the allowable range was set to the cooling proportional gain (KPC) during PID control.	Continue	Set a value in the range 1 to 32767 to the cooling proportional gain (KPC). (If an error occurs, set the cooling proportional gain (KPC) to 1.)
8112H	Out of parameter setting range	A value outside the allowable range was set to the integral time (TI) during PID control.	Continue	Set a value for the integral time (TI) in the range 0 to 32767. (If an error occurs, set the value for the integral time (TI) to 0.)
8113H	Out of parameter setting range	A value outside the allowable range was set to the differential time (TD) during PID control.	Continue	Set a value for the differential time (TD) in the range 0 to 32767. (If an error occurs, set the value for the differential time (TD) to 0.)
8114H	Out of parameter setting range	Values were set so that the sampling time (Ts) ≥ the control output cycle (heating control output cycle, cooling control output cycle) during PID control.	Continue	The values for the sampling time and control output cycle (heating control output cycle, cooling output cycle) cannot be changed. Set values so that the control output cycle (heating control output cycle, cooling output cycle) becomes larger than the sampling time. (If an error occurs, write back the value for the control output cycle to the value before change. When the mode is changed from two-position control to PID control, set a value obtained by following equation: A value obtained by discarding any fraction less than 100ms from the sampling time + 100ms.
8115H	Out of parameter setting range	A value outside the allowable range was set to the sampling time (Ts) during PID control.	Continue	Set a value for the sampling time (Ts) in the range 1 to 3000. Alternatively, set a value so that a value 10 times the sampling time is equal to or smaller than the differential time. Alternatively, make adjustment so that the scan time does not exceed the sampling time. (If an error occurs, set the scan time to the minimum/maximum value.)



Error code	Error name	Error details and cause	Stop/continue	Action
8116H	Out of parameter setting range	A value outside the allowable range was set to the control output cycle, heating control output cycle, or cooling control output cycle during PID control.	Continue	Set a value in the range 1 to 3000 for the control output cycle, heating control output cycle, or cooling control output cycle. (If an error occurs, the value for the control output cycle, heating control output cycle, or cooling control output cycle to the minimum value/maximum value.)
8117H	Out of parameter setting range	A value outside the allowable range was set to the adjustment sensitivity (dead band) PID control.	Continue	Set a value for the adjustment sensitivity (dead band) in the range 0 to 32760. (If an error occurs, set the adjustment sensitivity (dead band) to the minimum/maximum value.)
8118H	Out of parameter setting range	A value outside the allowable range was set to the upper limit output limiter during PID control.	Continue	Set a value for the upper limit output limiter in the range 1 to 1000. (If an error occurs, set the value for the upper limit output limiter to the minimum/maximum value.)
8119H	Out of parameter setting range	A value outside the allowable range was set to the upper limit output limiter during PID control.	Continue	Set a value for the upper limit output limiter in the range 1 to 1000. (If an error occurs, set the value for the upper limit output limiter to the minimum/maximum value.)
811AH	Out of parameter setting range	A value outside the allowable range was set to the heating upper limit output limiter during PID control.	Continue	Set a value for the heating upper limit output limiter in the range 0 to 1000. (If an error occurs, set the value for the heating upper limit output limiter to the minimum/maximum value.)
811BH	Out of parameter setting range	A value outside the allowable range was set to the cooling upper limit output limiter during PID control.	Continue	Set a value for the cooling upper limit output limiter in the range 0 to 1000. (If an error occurs, set the value for the cooling upper limit output limiter to the minimum/maximum value.)
811CH	Out of parameter setting range	A value outside the allowable range was set to the output change ratio limiter during PID control.	Continue	Set a value for the output change ratio limiter in the range 0 to 1000. (If an error occurs, set the value for the output change ratio limiter to the minimum/maximum value.)
811DH	Out of parameter setting range	A value outside the allowable range was set to the temperature rise completion range setting during PID control.	Continue	Set a value for the temperature rise completion range setting in the range 0 to 32760. (If an error occurs, set the value for the temperature rise completion range setting to the minimum/maximum value.)
811EH	Out of parameter setting range	A value outside the allowable range was set to the temperature rise completion soak time setting during PID control.	Continue	Set a value for temperature rise completion soak time setting in the range 0 to 32767. (If an error occurs, set the value for the temperature rise completion soak time setting to 0.)
811FH	PID control malfunction	The value for the upper limit output limiter was changed to a value equal to or smaller than the value for the lower limit output limiter during PID control.	Continue	The values for the upper limit output limiter and lower limit output limiter cannot be changed as upper limit output limiter $\leq$ lower limit output limiter. Set values so that the value for the upper limit output limiter is larger than the value for the lower limit output limiter. When an error occurs, write back the values for the upper limit output limiter and lower limit output limiter to the values before change.) When the mode is changed from two-position control to PID control, set the values to the default values (upper limit output limiter = 1000, lower limit output limiter = 0).
8120H	PID control malfunction	Correct control was not performed because the relation (which is larger) between the measured value (PV) and the ambient temperature setting was changed from the relation when PID control started.	Continue	Ensure that the relation (which is larger) between the measured value (PV) and the ambient temperature setting is not changed from the relation when PID control started.
8122H	Out of parameter setting range	A value outside the allowable range was set to the target value (SV) during PID control.	Continue	Set a value for the target value (SV) in the range -32760 to 32760. (If an error occurs, set the value for the target value (SV) to the minimum/maximum value.)
8124H	PID control malfunction	During PID control, the value for "Target value (SV) $\pm$ Adjustment sensitivity (dead band)" was set to that which was outside the range of the measured value (PV) (any value outside the range of -32767 to 32766).	Continue	Set a value larger than the lower limit or smaller than the upper limit of the range of the measured value (PV) (-32767~32766) for the value for "Target value (SV) $\pm$ Sensitivity (dead band)".

Error code	Error name	Error details and cause	Stop/continue	Action
8125H	Out of parameter setting range	The lower value than the operation cycle value of the programmable controller was set to the control output cycle setting, heating control output cycle setting, or cooling control output cycle setting.	Continue	Set a value larger enough than the scan time for the control output cycle setting, heating control output cycle setting, or cooling output cycle setting.
8200H	Auto-tuning measurement time error	<ul style="list-style-type: none"> <li>■For standard PID control <ul style="list-style-type: none"> <li>• The value for the upper limit output limiter is small.</li> <li>• The value for the lower limit output limiter is large.</li> </ul> </li> <li>■For heating-cooling PID control <ul style="list-style-type: none"> <li>• The value for the heating upper limit output limiter is small.</li> <li>• The value for the cooling upper limit output limiter is small.</li> </ul> </li> <li>■Common to PID control <ul style="list-style-type: none"> <li>• The heater power supply or cooling device power supply may not be turned ON.</li> <li>• Due to the influence of the environment, the temperature of the control target may be unable to fall or rise.</li> <li>• The operation direction estimated from the measured value at the start of auto tuning was different from the actual operation direction of the output during auto tuning.</li> </ul> </li> </ul>	Stop	<ul style="list-style-type: none"> <li>■For standard PID control <ul style="list-style-type: none"> <li>• Check the value for the upper limit output limiter and correct the value if it is smaller than 100%.</li> <li>• Check the value for the lower limit output limiter and correct the value if it is larger than 0%.</li> </ul> </li> <li>■For heating-cooling PID control <ul style="list-style-type: none"> <li>• Check the value for the heating upper limit output limiter and correct the value if it is smaller than 100%.</li> <li>• Check the value for the cooling upper limit output limiter and correct the value if it is smaller than 100%.</li> </ul> </li> <li>■Common to PID control <ul style="list-style-type: none"> <li>• Check that the heater power supply or cooling device power supply is turned ON.</li> <li>• Due to the influence of the environment, the temperature of the control target may be unable to fall or rise. Stop controlling the adjacent control targets and execute auto tuning for the control target individually.</li> <li>• Correct the relationship between the target value and the measured value, and then execute auto tuning again.</li> </ul> </li> </ul>
8201H	Out of parameter setting range	Correct PID control constants could not be found because the target value (SV) was changed during auto tuning.	Stop	Do not change the target value (SV) during auto tuning. Execute auto tuning again.
8202H	Out of parameter setting range	Correct PID control constants could not be found because the sampling time (Ts) was changed during auto tuning.	Stop	Do not change the sampling time (Ts) during auto tuning. Execute auto tuning again.
8203H	Out of parameter setting range	Correct PID control constants could not be found because the value for the upper limit output limiter was changed during auto tuning.	Stop	Do not change the value for the upper limit output limiter during auto tuning. Execute auto tuning again.
8204H	Out of parameter setting range	Correct PID control constants could not be found because the value for the lower limit output limiter was changed during auto tuning.	Stop	Do not change the value for the lower limit output limiter during auto tuning. Execute auto tuning again.
8205H	Out of parameter setting range	Correct PID control constants could not be found because the value for the heating upper limit output limiter was changed during auto tuning.	Stop	Do not change the value for the heating upper limit output limiter during auto tuning. Execute auto tuning again.
8206H	Out of parameter setting range	Correct PID control constants could not be found because the value for the cooling upper limit output limiter was changed during auto tuning.	Stop	Do not change the value for the cooling upper limit output limiter during auto tuning. Execute auto tuning again.
8207H	Out of parameter setting range	Correct PID control constants could not be found because the value for the control output cycle, heating control output cycle, or cooling control output cycle was changed during auto tuning.	Stop	Do not change the control output cycle, heating control output cycle, or cooling control output cycle during auto-tuning. Execute auto tuning again.
8208H	Out of parameter setting range	Auto tuning could not be executed because the value for the upper limit output limiter, heating upper limit output limiter, or cooling upper limit output limiter was smaller than 1 (0.1%).	Stop	To execute auto tuning, set the value for the upper limit output limiter, heating upper limit output limiter, or cooling upper limit output limiter equal to or larger than 1 (0.1%). Execute auto tuning again.
8209H	Out of parameter setting range	Auto tuning could not be executed because the value for the lower limit output limiter was equal to or larger than 1000 (100.0%).	Stop	To execute auto tuning, set the value for the lower limit output limiter smaller than 999 (99.9%). Execute auto tuning again.
8210H	PID control malfunction	The value for the control output cycle (heating control output cycle, cooling output cycle) was set to equal to or smaller than the sampling time (Ts) when PID control started.	Stop	Set values so that the control output cycle (heating control output cycle, cooling output cycle) becomes larger than the sampling time.
8211H	PID control malfunction	The value for the upper limit output limiter was equal to or smaller than the value for the lower limit output limiter when PID control started.	Stop	Set values so that the value for the upper limit output limiter is larger than the value for the lower limit output limiter.

Error code	Error name	Error details and cause	Stop/continue	Action
8213H	PID control malfunction	A PID operation result overflow occurred.	Stop	PID control was not executed correctly. Check and correct the values for the proportional gain (Kp), heating proportional gain (Kph), cooling proportional gain (Kpc), integral time (TI), differential time (TD), and sampling time (Ts).
8214H	Parameter error	An incorrect parameter was detected at starting of PID control.	Stop	If the firmware version of the FX5U/FX5UC CPU module is less than 1.290, set the overlap/dead band settings as follows. <ul style="list-style-type: none"> <li>Setting value: 0</li> <li>Device indirect specification: Empty</li> </ul>
8230H	PAUSE detection	The status changed to PAUSE during auto tuning or PID control.	Stop	Do not change the status into PAUSE during auto tuning or PID control.

## Error codes of the file transfer function (C616H to C622H)

The following table lists the error codes of completion status errors that occur in the file transfer function (FTP client).

Error code	Error name	Error details and cause	Action
C616H to C622H	 MELSEC iQ-F FX5 User's Manual (Communication)		

## Error codes of the CC-Link IE Field Network Basic (CFC0H to CFFFH)

The following table lists the error codes detected by the CC-Link IE Field Network Basic function.

Error code	Error name	Error details and cause	Action
CFC0H	Cyclic transmission error (master station)	<ul style="list-style-type: none"> <li>Unable to execute cyclic transmission because multiple master stations exist in the same network address.</li> </ul>	<ul style="list-style-type: none"> <li>Check the existence status of master station in network.</li> </ul>
CFC1H	Cyclic transmission error (master station)	<ul style="list-style-type: none"> <li>Unable to execute cyclic transmission because the error occurred in cyclic transmission.</li> </ul>	<ul style="list-style-type: none"> <li>Take measures to reduce noise.</li> <li>If the same error is displayed again, please contact your local Mitsubishi representative.</li> </ul>
CFC8H	Cyclic transmission error (master station)	<ul style="list-style-type: none"> <li>Unable to execute cyclic transmission because the remote station controlled by other master station exists.</li> </ul>	<ul style="list-style-type: none"> <li>Check the existence status of master station in network.</li> <li>Check the remote station where the error occurred.</li> </ul>
CFC9H	Cyclic transmission error (master station)	<ul style="list-style-type: none"> <li>Unable to execute cyclic transmission because the remote station of the same IP address exists in the same network address.</li> </ul>	<ul style="list-style-type: none"> <li>Check the existence status of the remote station in network.</li> <li>Check the remote station where the error occurred.</li> </ul>
CFD0H	Master station error	<ul style="list-style-type: none"> <li>The port No. (61450) used in CC-Link IE Field Network Basic has already been used.</li> </ul>	<ul style="list-style-type: none"> <li>Check the port No. used in Ethernet function.</li> </ul>
CFD1H	Master station error	<ul style="list-style-type: none"> <li>Invalid value has been set in subnet mask.</li> </ul>	<ul style="list-style-type: none"> <li>Check the parameter setting.</li> </ul>
CFE0H	Cyclic transmission error (remote station)	<ul style="list-style-type: none"> <li>The cyclic transmission was executed for the remote station controlled by other master station.</li> </ul>	<ul style="list-style-type: none"> <li>Check the existence status of master station in network.</li> <li>Check the remote station where the error occurred.</li> </ul>
CFE1H	Cyclic transmission error (remote station)	<ul style="list-style-type: none"> <li>The unusable number of occupied stations has been specified from master station.</li> </ul>	<ul style="list-style-type: none"> <li>Check the number of occupied stations setting in master station parameter (Network Configuration Settings).</li> </ul>
CFE8H	Cyclic transmission error (remote station)	<ul style="list-style-type: none"> <li>There is no response from the remote station.</li> </ul>	<ul style="list-style-type: none"> <li>Check the remote station disconnection detection setting in master station parameter (Network Configuration Settings).</li> <li>Check the existence status of the remote station in network.</li> <li>Check the remote station where the disconnection occurred.</li> <li>Take measures to reduce noise.</li> </ul>
CFE9H	Cyclic transmission error (remote station)	<ul style="list-style-type: none"> <li>The remote station of the same IP address has existed in the same network address.</li> </ul>	<ul style="list-style-type: none"> <li>Check the remote station where the error occurred.</li> </ul>
CFF0H	Remote station error	<ul style="list-style-type: none"> <li>An error occurred in the remote station.</li> </ul>	<ul style="list-style-type: none"> <li>Check the remote station where the error occurred.</li> </ul>

## Error codes of the analog function (0000H to 3084H)

The following table lists the error codes that may be stored.

□: Indicates the channel number (1: CH1 to 4: CH4) where the error occurred.

### ■For the CPU module built-in analog function

#### • Analog input

Error code	Error name	Error details and cause	Action
0000H	—	There is no error.	—
1A0□H	Averaging process specification setting range error	A value other than 0 to 3 was set in CH□ average processing setting.	Reset CH□ the average processing setting to 0 to 3.
1A1□H	Average time setting range error	When the time average is set to CH□ averaging processing setting, a value other than 1 to 10000 was set to CH□ time average/count average/moving average settings.	Reset CH□ time average/count average/moving average settings to the following value. 1 to 10000
1A2□H	Average count setting range error	When the count average is set to CH□ averaging processing setting, a value other than 4 to 32767 was set to CH□ time average/count average/moving average settings.	Reset CH□ time average/count average/moving average settings to the following value. 4 to 32767
1A3□H	Moving average count setting range error	When the moving average is set to CH□ average processing setting, a value other than the following was set to CH□ time average/count average/moving average settings. 2 to 64	Reset CH□ time average/count average/moving average settings to the following value. 2 to 64
1A4□H	Process alarm upper-lower limit value setting range error	The value not meeting the following conditions was set to CH□ process alarm upper-upper limit value to CH□ process alarm lower-lower limit value. Upper-upper limit value ≥ Upper-lower limit value ≥ Lower-upper limit value ≥ Lower-lower limit value	Reset CH□ process alarm upper-upper limit value to CH□ process alarm lower-lower limit value to the value meeting the following conditions. Upper-upper limit value ≥ Upper-lower limit value ≥ Lower-upper limit value ≥ Lower-lower limit value
1A7□H	Scaling upper and lower limit value setting error	CH□ scaling upper limit value and CH□ scaling lower limit value are equal.	Reset CH□ scaling upper limit value or CH□ scaling lower limit value such that Scaling upper limit value ≠ Scaling lower limit value.

#### • Analog output

Error code	Error name	Error details and cause	Action
0000H	—	There is no error.	—
1B01H	Warning output upper and lower limit value inversion error	Values that do not satisfy the following relation are set in warning output upper limit value and warning output lower limit value: Upper limit value > Lower limit value	Set the warning output upper limit value and warning output lower limit value so that upper limit value > lower limit value.
1B11H	HOLD output state setting range error	A value other than 0, 1 or, 2 was set in the HOLD/CLEAR function setting.	Set a value between 0 and 2 to the HOLD/CLEAR function setting.
1B21H	HOLD output set value range error	The HOLD output set value is outside the range between the scaling lower limit value and scaling upper limit value.	Specify the HOLD output set value to fall within the range between the scaling lower limit value and scaling upper limit value.
1B71H	Scaling upper and lower limit value setting error	Scaling upper limit value and CH□ scaling lower limit value are equal.	Reset Scaling upper limit value or CH□ scaling lower limit value such that Scaling upper limit value ≠ Scaling lower limit value.

### ■For the analog adapter

#### • Analog input

Error code	Error name	Error details and cause	Action
0000H	—	There is no error.	—
1A0□H	Averaging process specification setting range error	A value other than 0 to 3 was set in CH□ average processing setting.	Reset CH□ the average processing setting to 0 to 3.
1A1□H	Average time setting range error	When the time average is set to CH□ averaging processing setting, a value other than 1 to 10000 was set to CH□ time average/count average/moving average settings.	Reset CH□ time average/count average/moving average settings to the following value. 1 to 10000

Error code	Error name	Error details and cause	Action
1A2□H	Average count setting range error	When the count average is set to CH□ averaging processing setting, a value other than 4 to 32767 was set to CH□ time average/count average/moving average settings.	Reset CH□ time average/count average/moving average settings to the following value. 4 to 32767
1A3□H	Moving average count setting range error	When the moving average is set to CH□ Averaging process specification, a value other than the following was set to CH□ Time average/count average/moving average settings. 2 to 64	Reset CH□ time average/count average/moving average settings to the following value. 2 to 64
1A4□H	Process alarm upper-lower limit value setting range error	The value not meeting the following conditions was set to CH□ process alarm upper-upper limit value to CH□ process alarm lower-lower limit value. Upper-upper limit value $\geq$ Upper-lower limit value $\geq$ Lower-upper limit value $\geq$ Lower-lower limit value	Reset CH□ process alarm upper-upper limit value to CH□ process alarm lower-lower limit value to the value meeting the following conditions. Upper-upper limit value $\geq$ Upper-lower limit value $\geq$ Lower-upper limit value $\geq$ Lower-lower limit value
1A5□H	Rate alarm upper limit value/lower limit value setting inversion error	A value satisfying "lower limit value $\geq$ upper limit value" was set to CH□ rate alarm upper limit value and CH□ rate alarm lower limit value.	Reset CH□ rate alarm upper limit value and CH□ rate alarm lower limit value to lower limit value<upper limit value.
1A6□H	Rate alarm warning detection period setting range error	A value other than 1 to 10000 was set to CH□ rate alarm warning detection period setting.	Reset the CH□ rate alarm warning detection period setting to the value within 1 to 10000.
1A7□H	Scaling upper and lower limit value setting error	CH□ scaling upper limit value and CH□ scaling lower limit value are equal.	Reset CH□ scaling upper limit value or CH□ scaling lower limit value such that Scaling upper limit value $\neq$ Scaling lower limit value.
1A8□H	Range setting range error	A value outside the range was set to the CH□ range setting.	Reset the CH□ range setting to the following value. 0 to 6
1A9□H	Offset/Gain setting value range error	A value outside the range was set to CH□ Offset setting value or CH□ Gain setting value.	Reset CH□ Offset setting value or CH□ Gain setting value to the following value. ■Voltage Offset value: -10000 to +9000 Gain value: -9000 to +10000 ■Current Offset value: -20000 to +17000 Gain value: -17000 to +30000
1AA□H	Range setting range error with disconnection detection enabled	CH□ Disconnection detection functions were set to Enable and CH□ Input range is set to those other than the following. • 1 to 5V • 4 to 20mA	For the channel detecting simple disconnection using the disconnection detection function, reset CH□ Input range to any of the following. • 1 to 5V • 4 to 20mA
1AC□H	Convergence detection time setting range error	A value other than 1 to 10000 was set to CH□ Convergence detection time setting.	Reset CH□ Convergence detection time setting to the value within 1 to 10000.
1AD□H	Convergence detection upper limit value/lower limit value setting inversion error	A value satisfying "lower limit value $\geq$ upper limit value" was set to CH□ Convergence detection upper limit value and CH□ Convergence detection lower limit value.	Reset CH□ Convergence detection upper limit value and CH□ Convergence detection lower limit value so that upper limit value is larger than lower limit value.
1AF□H	Offset/Gain setting write error	During CH□ Offset/Gain setting write or CH□ Offset/Gain setting initialization, "CH□ A/D conversion enable/disable setting" was set to conversion enable.	Set "CH□ A/D conversion enable/disable setting" to conversion disable, and write CH□ Offset/Gain setting or initialize CH□ Offset/Gain setting.
1D7□H	Offset/Gain computed value range error	CH□ Offset/Gain computed value became out of range.	Reset CH□ Offset value and CH□ Gain setting value.
3080H	Analog ADP Hardware error	Hardware error of analog ADP was detected.	After resetting the CPU module, carry out RUN. If the same error is displayed again, there is a possibility of hardware error of the analog ADP. Consult the nearest Mitsubishi Electric representative.
3081H	Analog ADP Power failure	The power is not supplied to the analog ADP normally.	Confirm if the power is supplied to the analog ADP properly.
3082H	Analog ADP Memory Error	An analog ADP memory error was detected.	After resetting the CPU module, carry out RUN. If the same error is displayed again, there is a possibility of analog ADP hardware failure. Consult the nearest Mitsubishi Electric representative.
3083H	Analog ADP Memory Error	An error was detected in offset/gain setting data of the analog ADP.	After offset/gain initialization of the analog ADP is finished, set the data by offset/gain settings again.
3084H	Analog ADP Communication error	Communication error occurred between the analog ADP and the CPU module.	Confirm if ADP is connected properly to the CPU module. If not improved, consult the nearest Mitsubishi Electric representative.

• Analog output

Error code	Error name	Error details and cause	Action
0000H	—	There is no error.	—
1B0□H	Warning output upper and lower limit value inversion error	The value not meeting the following condition was set to CH□ Warning output upper limit value and CH□ Warning output lower limit value. Upper limit value>Lower limit value	Reset CH□ Warning output upper limit value and CH□ Warning output lower limit value such that upper limit value>lower limit value.
1B1□H	HOLD output state setting range error	A value other than 0 to 2 was set in the CH□ HOLD/CLEAR function setting.	Set a value between 0 and 2 to the CH□ HOLD/CLEAR function setting.
1B2□H	HOLD output set value range error	CH□ Output setting value during HOLD is set outside the range of scaling upper and lower limit value.	Set CH□ Output setting value during HOLD within the range of scaling upper and lower limit value.
1B7□H	Scaling upper and lower limit value setting error	CH□ Scaling upper limit value and CH□ Scaling lower limit value are equal.	Reset CH□ Scaling upper limit value or CH□ scaling lower limit value such that Scaling upper limit value≠Scaling lower limit value.
1B8□H	Range setting range error	A value outside the range was set to the CH□ range setting.	Reset the CH□ range setting to the following value. 0 to 5
1B9□H	Offset/Gain setting value range error	A value outside the range was set to CH□ Offset setting value or CH□ Gain setting value.	Reset CH□ Offset setting value or CH□ Gain setting value to the following value. ■Voltage Offset value: -10000 to +9000 Gain value: -9000 to +10000 ■Current Offset value: 0 to 17000 Gain value: 3000 to 30000
1BA□H	Range setting range error with disconnection detection enabled	CH□ Disconnection detection functions were set to Enable and CH□ Output range is set to other than the following. • 4 to 20mA	For the channel detecting disconnection using the disconnection detection function, reset CH□ Output range to any of the following. • 4 to 20mA
1BB□H	Disconnection detection error	In CH□, disconnection was detected.	Eliminate the cause of the disconnection in the channel and turn on the "error clear request" (SM50).
1BF□H	Offset/Gain setting write error	During CH□ Offset/Gain setting write or CH□ Offset/Gain setting initialization, 'CH□ D/A conversion enable/disable setting' was set to conversion enable.	Set 'CH□ D/A conversion enable/disable setting' to conversion disable and write CH□ Offset /Gain setting or initialize CH□ Offset/Gain setting.
1D7□H	Offset/Gain computed value range error	CH□ Offset/Gain computed value became out of range.	Reset CH□ Offset value and CH□ Gain setting value.
3080H	Analog ADP Hardware error	Hardware error of analog ADP was detected.	After resetting the CPU module, carry out RUN. If the same error is displayed again, there is a possibility of hardware error of the analog ADP. Consult the nearest Mitsubishi Electric representative.
3081H	Analog ADP Power failure	The power is not supplied to the analog ADP normally.	Confirm if the power is supplied to the analog ADP properly.
3082H	Analog ADP Memory Error	An analog ADP memory error was detected.	After resetting the CPU module, carry out RUN. If the same error is displayed again, there is a possibility of analog ADP hardware failure. Consult the nearest Mitsubishi Electric representative.
3083H	Analog ADP Memory Error	An error was detected in offset/gain setting data of the analog ADP.	After offset/gain initialization of the analog ADP is finished, set the data by offset/gain settings again.
3084H	Analog ADP Communication error	Communication error occurred between the analog ADP and the CPU module.	Confirm if ADP is connected properly to the CPU module. If not improved, consult the nearest Mitsubishi Electric representative.

• Temperature sensor input

Error code	Error name	Error details and cause	Action
0000H	—	There is no error.	—
1A0□H	Averaging process specification setting range error	A value other than 0 to 3 was set in CH□ average processing setting.	Reset CH□ the average processing setting to 0 to 3.
1A1□H	Average time setting range error	When the time average is set to CH□ averaging processing setting, a value other than 340 to 10000 was set to CH□ time average/count average/moving average settings.	Reset CH□ time average/count average/moving average settings to the following value. 340 to 10000

Error code	Error name	Error details and cause	Action
1A2□H	Average count setting range error	When the count average is set to CH□ averaging processing setting, a value other than 4 to 4095 was set to CH□ time average/count average/moving average settings.	Reset CH□ time average/count average/moving average settings to the following value. 4 to 4095
1A3□H	Moving average count setting range error	When the moving average is set to CH□ Averaging process specification, a value other than the following was set to CH□ Time average/count average/moving average settings. 2 to 64	Reset CH□ time average/count average/moving average settings to the following value. 2 to 64
1A4□H	Process alarm upper-lower limit value setting range error	The value not meeting the following conditions was set to CH□ process alarm upper-upper limit value to CH□ process alarm lower-lower limit value. Upper-upper limit value ≥ Upper-lower limit value ≥ Lower-upper limit value ≥ Lower-lower limit value	Reset CH□ process alarm upper-upper limit value to CH□ process alarm lower-lower limit value to the value meeting the following conditions. Upper-upper limit value ≥ Upper-lower limit value ≥ Lower-upper limit value ≥ Lower-lower limit value
1A5□H	Rate alarm upper limit value/lower limit value setting inversion error	A value satisfying "lower limit value ≥ upper limit value" was set to CH□ rate alarm upper limit value and CH□ rate alarm lower limit value.	Reset CH□ rate alarm upper limit value and CH□ rate alarm lower limit value to lower limit value < upper limit value.
1A6□H	Rate alarm warning detection period setting range error	A value other than 85 to 10000 was set to CH□ rate alarm warning detection period setting.	Reset the CH□ rate alarm warning detection period setting to the value within 85 to 10000.
1A8□H	<ul style="list-style-type: none"> <li>• Range setting/resistance temperature detector type error</li> <li>• Range setting/resistance temperature detector type setting/thermocouple type range error</li> </ul>	A value outside the range was set.	Reset the CH□ range setting to the following value. 0 to 1
1AB□H	Conversion setting range error with disconnection detection enabled	A value outside the range was set to CH□ conversion setting for disconnection detection.	Set CH□ conversion setting for disconnection detection to the following value. 0 to 3
1AF□H	Offset/Gain setting write error	During CH□ Offset/Gain setting write or CH□ Offset/Gain setting initialization, "CH□ conversion enable/disable setting" was set to conversion enable.	Set "CH□ conversion enable/disable setting" to conversion disable, and write CH□ Offset/Gain setting or initialize CH□ Offset/Gain setting.
1D0□H	Offset/Gain input value error	At the temperature conversion, the input offset value and input gain value do not satisfy the following condition. <ul style="list-style-type: none"> <li>• Centigrade: Input gain value - input offset value &gt; 0.1°C</li> <li>• Fahrenheit: Input gain value - input offset value &gt; 0.3°F</li> </ul>	At the temperature conversion, correct values so that the input offset value and input gain value satisfy the following condition. <ul style="list-style-type: none"> <li>• Centigrade: Input gain value - input offset value &gt; 0.1°C</li> <li>• Fahrenheit: Input gain value - input offset value &gt; 0.3°F</li> </ul>
1D1□H	Offset/Gain temperature setting value error	The set offset/gain temperature setting values are outside the ranges. Or the set offset/gain temperature setting values do not satisfy the following condition. <ul style="list-style-type: none"> <li>• Centigrade: Gain temperature setting value - offset temperature setting value &gt; 0.1°C</li> <li>• Fahrenheit: Gain temperature setting value - offset temperature setting value &gt; 0.3°F</li> </ul>	Correct values so that the offset/gain temperature setting values satisfy the following condition. <ul style="list-style-type: none"> <li>• Centigrade: Gain temperature setting value - offset temperature setting value &gt; 0.1°C</li> <li>• Fahrenheit: Gain temperature setting value - offset temperature setting value &gt; 0.3°F</li> </ul>
3080H	Analog ADP Hardware error	Hardware error of analog ADP was detected.	After resetting the CPU module, carry out RUN. If the same error is displayed again, there is a possibility of hardware error of the analog ADP. Consult the nearest Mitsubishi Electric representative.
3081H	Analog ADP Power failure	The power is not supplied to the analog ADP normally.	Confirm if the power is supplied to the analog ADP properly.
3082H	Analog ADP Memory Error	An analog ADP memory error was detected.	After resetting the CPU module, carry out RUN. If the same error is displayed again, there is a possibility of analog ADP hardware failure. Consult the nearest Mitsubishi Electric representative.
3083H	Analog ADP Memory Error	An error was detected in offset/gain setting data of the analog ADP.	After offset/gain initialization of the analog ADP is finished, set the data by offset/gain settings again.
3084H	Analog ADP Communication error	Communication error occurred between the analog ADP and the CPU module.	Confirm if ADP is connected properly to the CPU module. If not improved, consult the nearest Mitsubishi Electric representative.



# Appendix 4 Alarm Code

The following table shows the list of the alarm codes stored.

□: Indicates the number of the channel where an alarm has occurred. (1: CH1 to 4: CH4)

## For the CPU module built-in analog function

### • Analog input

Alarm code	Alarm name	Description and cause	Action
080□H	Process alarm (upper limit)	The process alarm (upper limit) has occurred in CH□.	When the CH□ digital operation value returns from the warning output range, the alarm code automatically changes to "0: Normal".
081□H	Process alarm (lower limit)	The process alarm (lower limit) has occurred in CH□.	
090□H	Over-limit detection	The over-limit (upper limit) has occurred in CH□.	If the alarm clear request is turned ON after the analog input value falls within the set range, all the over-limit detection flags are set to "0: Normal" and the alarm code in the A/D conversion latest alarm code is cleared.
0F0□H	Changing the setting with setting change not allowed	The setting was changed when setting change was not allowed.	Change the setting with setting change allowed.

### • Analog output

Alarm code	Alarm name	Description and cause	Action
0801H	Warning output alarm (upper limit)	The warning output alarm (upper limit side) has occurred.	If the alarm clear request is turned ON after the digital operation value returns from the warning output range, the warning output flag changes to "0: Normal".
0811H	Warning output alarm (lower limit)	The warning output alarm (lower limit side) has occurred.	
0F01H	Changing the setting with setting change not allowed	The setting was changed when setting change was not allowed.	Change the setting with setting change allowed.

## For the analog adapter

### • Analog input

Alarm code	Alarm name	Description and cause	Action
0000H	—	There is no error.	—
080□H	Process alarm (upper limit)	The process alarm (upper limit) has occurred in CH□.	When the CH□ digital operation value returns from the warning output range, the alarm code automatically changes to "0: Normal".
081□H	Process alarm (lower limit)	The process alarm (lower limit) has occurred in CH□.	
082□H	Rate alarm (upper limit)	The rate alarm (upper limit) has occurred in CH□.	When the change ratio of the CH□ digital operation value returns to the setting range, the alarm code automatically changes to "0: Normal".
083□H	Rate alarm (lower limit)	The rate alarm (lower limit) has occurred in CH□.	
090□H	Over scale (upper limit)	The over-limit (upper limit) has occurred in CH□.	If the alarm clear request is turned ON after the analog input value falls within the set range, all the over-limit detection flags are set to "0: Normal" and the alarm code in the A/D conversion latest alarm code is cleared.
091□H	Over scale (lower limit)	The over-limit (lower limit) has occurred in CH□.	
0A0□H	Disconnection detection	Disconnection is detected in the CH□.	When the alarm clear request is set to ON after the CH□ is recovered from disconnection, all CH disconnection detection flags become "0: Normal", and the alarm code stored in the "A/D conversion latest alarm code" is cleared.
0B0□H	Deviation detection between channels	Deviation is detected in the CH□.	When the deviation between the CH□ becomes less than the deviation value for deviation between CH detection, the deviation between CH detection flag automatically becomes "0: Normal".
0C0□H	Offset/gain reading input range mismatch	The saved offset/gain input range is different from the currently set input range.	Change the currently set input range to the input range selected when the offset/gain was written, and then read the offset/gain.



Alarm code	Alarm name	Description and cause	Action
0E0□H	Range change alarm during offset/gain writing or offset/gain initialization	The range was changed during offset/gain writing or offset/gain initialization.	Wait until offset/gain writing or offset/gain initialization is finished, and then change the range.
0E1□H	Offset/gain initialization execution alarm	Offset/gain initialization was executed during offset/gain writing.	Wait until offset/gain writing is finished, and then initialize the offset/gain.
0E2□H	Offset/gain writing execution alarm	Offset/gain writing was executed during offset/gain initialization.	Wait until offset/gain initialization is finished, and then write the offset/gain.
0E3□H	Analog ADP memory access alarm	Offset/gain writing, offset/gain reading, or offset/gain initialization was executed while the analog ADP memory error (Error code: 3082H) occurred. Or, offset reading was performed while an analog ADP memory error (Error code: 3083H) occurred.	Reset the CPU module.
0F0□H	Setting change alarm	Special relays/registers for analog are changed while conversion is enabled.	Change the setting of special relays/registers while conversion is disabled.

• Analog output

Alarm code	Alarm name	Description and cause	Action
0000H	—	There is no error.	—
080□H	Warning output alarm (upper limit)	The warning output alarm (upper limit side) has occurred in CH□.	When the CH□ digital operation value returns from the warning output range, the alarm code automatically changes to "0: Normal".
081□H	Warning output alarm (lower limit)	The warning output alarm (lower limit side) has occurred in CH□.	
0C0□H	Offset gain reading output range mismatch	The saved offset/gain output range is different from the currently set output range.	Change the currently set output range to the output range selected when the offset/gain was written, and then read the offset/gain.
0E0□H	Range change alarm during offset/gain writing or offset/gain initialization	The range was changed during offset/gain writing or offset/gain initialization.	Wait until offset/gain writing or offset/gain initialization is finished, and then change the range.
0E1□H	Offset/gain initialization execution alarm	Offset/gain initialization was executed during offset/gain writing.	Wait until offset/gain writing is finished, and then initialize the offset/gain.
0E2□H	Offset/gain writing execution alarm	Offset/gain writing was executed during offset/gain initialization.	Wait until offset/gain initialization is finished, and then write the offset/gain.
0E3□H	Analog ADP memory access alarm	Offset/gain writing, offset/gain reading, or offset/gain initialization was executed while the analog ADP memory error (Error code: 3082H) occurred. Or, offset reading was performed while an analog ADP memory error (Error code: 3083H) occurred.	Reset the CPU module.
0F0□H	Setting change alarm	Special relays/registers for analog are changed while conversion is enabled.	Change the setting of special relays/registers while conversion is disabled.

• Temperature sensor input

Alarm code	Alarm name	Description and cause	Action
0000H	—	There is no error.	—
080□H	Process alarm (upper limit)	The process alarm (upper limit) has occurred in CH□.	When CH□ measured temperature value returns from the warning output range, the alarm code automatically changes to "0: Normal".
081□H	Process alarm (lower limit)	The process alarm (lower limit) has occurred in CH□.	
082□H	Rate alarm (upper limit)	The rate alarm (upper limit) has occurred in CH□.	When the change of CH□ measured temperature value from the previous value returns to the setting range, the alarm code automatically changes to "0: Normal".
083□H	Rate alarm (lower limit)	The rate alarm (lower limit) has occurred in CH□.	
0A0□H	Disconnection detection	Disconnection is detected in the CH□.	When the conversion alarm clear request is set to ON after the CH□ is recovered from disconnection, all CH disconnection detection flag become "0: Normal", and the alarm code stored in the "conversion latest alarm code" is cleared.
0C0□H	Offset/gain reading RTD type mismatch	The saved offset/gain RTD type is different from the currently set RTD type.	Change the currently set RTD type to the RTD type selected when the offset/gain was written, and then read the offset/gain.
	Offset/gain reading thermocouple type mismatch	The saved offset/gain thermocouple type is different from the currently set thermocouple type.	Change the currently set thermocouple type to the thermocouple type selected when the offset/gain was written, and then read the offset/gain.



Alarm code	Alarm name	Description and cause	Action
0E0□H	RTD type change alarm during offset/gain writing or offset/gain initialization	The RTD type was changed during offset/gain writing or offset/gain initialization.	Wait until offset/gain writing or offset/gain initialization is finished, and then change the RTD type.
	Thermocouple type change alarm during offset/gain writing or offset/gain initialization	The thermocouple type was changed during offset/gain writing or offset/gain initialization.	Wait until offset/gain writing or offset/gain initialization is finished, and then change the thermocouple type.
0E1□H	Offset/gain initialization execution alarm	Offset/gain initialization was executed during offset/gain writing.	Wait until offset/gain writing is finished, and then initialize the offset/gain.
0E2□H	Offset/gain writing execution alarm	Offset/gain writing was executed during offset/gain initialization.	Wait until offset/gain initialization is finished, and then write the offset/gain.
0E3□H	Analog ADP memory access alarm	Offset/gain writing, offset/gain reading, or offset/gain initialization was executed while the analog ADP memory error (Error code: 3082H) occurred. Or, offset reading was performed while an analog ADP memory error (Error code: 3083H) occurred.	Reset the CPU module.
0F0□H	Setting change alarm	Special relays/registers for analog are changed while conversion is enabled.	Change the setting of special relays/registers while conversion is disabled.

# Appendix 5 Parameter List

A parameter list is shown below.

## System parameters

Item			Parameter No.
I/O Assignment Setting	Model Name	—	0203H
	Intelligent Module No.	—	0200H
	Serial Communication ch	—	0200H
	Number of Input Points	—	0200H
	Number of Output Points	—	0200H
	CPU Module Operation at Error Detection	—	0200H

## CPU parameters

Item			Parameter No.
Name Setting	Title Setting	Title	3100H
	Comment Setting	Comment	3101H
Operation Related Setting	RUN Contact Setting	RUN Contact Operation	3201H
	Remote Reset Setting	Remote Reset	3202H
	Clock Related Setting	Time Zone	3209H
		Comment	3209H
Interrupt Settings	Fixed Scan Interval Setting	Interrupt Setting from Internal Timer	3A00H
	Fixed Scan Execution Mode Setting	Fixed Scan Execution Mode	3A00H
	Interrupt Priority Setting from Module	Multiple Interrupt	3A01H
		Interrupt Priority	3A01H
Index Register Save/Restoration		3A00H	
Service Processing Setting	Device/Label Access Service Processing Setting	Specifying Method	3B00H
File Setting	Initial Value Setting	Setting of Device Initial Value Use Or Not	3301H
		Target Memory	3301H
		Global Device Initial Value File Name	3301H
Memory/Device Setting	Device/Label Memory Area Setting	Option Battery Setting	320AH
		Device/Label Memory Area Capacity Setting	3400H
		Device/Label Memory Area Detailed Setting	3401H
	Index Register Setting	Points Setting	3402H
	Pointer Setting	Total Points	340BH
	Internal Buffer Capacity Setting	Total Capacity	340AH
RAS Setting	Scan Time Monitoring Time (WDT) Setting	Initial Scan	3500H
		After 2nd Scan	3500H
	Constant Scan Setting	Constant Scan	3503H
	Error Detections Setting	Battery Error	3501H
		Module Verify Error	3501H
	CPU Module Operation Setting at Error Detected	Instruction Execution Error	3501H
		Memory Card Error	3501H
		Module Verify Error	3501H
		System Configuration Error	3501H
	LED Display Setting	ERROR LED	3502H
		BATTERY LED	3502H
Event History Setting	Save Destination	3504H	
	Storage Capacity Setting per File	3504H	
Program Setting	Program Setting	Program Setting	3700H
	FB/FUN File Setting	FB/FUN File Setting	3702H
	Program Capacity Setting	Program Capacity Setting	3703H

A

Item			Parameter No.
SFC Setting	SFC Program Setting	To Use or Not to Use SFC	3C10H
	SFC Program Start Mode Setting	SFC Program Start Mode	3C00H
	Start Conditions Setting	Start Conditions	3C00H
	FX3 Compatible Transition Operation Mode Setting	FX3 Compatible Transition Operation Mode	3C10H

## Module parameters

### Ethernet Port

Item			Parameter No.
Basic Settings	Own Node Settings	IP Address	A012H
		Communication Data Code	A030H
		Required I/O points	AD0H
	CC-Link IEF Basic Setting	To Use or Not to Use CC-Link IEF Basic Setting	7A00H
		Network Configuration Settings	7A00H
		Refresh Settings	7420H
	MODBUS/TCP Settings	To Use or Not to Use MODBUS/TCP Setting	A031H
		Device Assigned	A0B2H
	External Device Configuration	External Device Configuration	A031H
	Application Settings	FTP Server Settings	FTP Server
Login Name			A037H
Advanced Settings			A037H
Web Server Settings		To Use or Not to USE Web Server Settings	A035H
		HTTP Port No.	A035H
		Account Settings	A035H
Security		IP Filter Settings	A03AH
		Disable Direct Connection with MELSOFT	A034H
		Do Not Respond to CPU Module Search	A024H
Time Setting		Time Setting (SNTP client)	A039H
Simple PLC Communication Setting		Simple PLC Communication Setting	7A10H
FTP Client Settings		To Use or Not to Use FTP Client Settings	A03DH
		FTP Server Specification	A03DH
		Login Name	A03DH
		Password	A03DH
		Connection Method	A03DH
	Port No.	A03DH	

## 485 Serial Port

### ■MELSOFT Connection

Item			Parameter No.
Basic Settings	Communication Protocol Type	Communication Protocol Type	8000H

### ■Non-Protocol Communication

Item			Parameter No.	
Basic Settings	Communication Protocol Type	Communication Protocol Type	8001H	
	Advanced Settings	Data Length		8001H
		Parity Bit		8001H
		Stop Bit		8001H
		Baud Rate		8001H
		Header		8001H
		Header Setting Value		8001H
		Terminator		8001H
		Terminator Setting Value		8001H
		Control Mode (RS-232C)		8001H
		Control Mode (RS-485)		8001H
	Sum Check Code		8001H	
	Control Procedure		8001H	
Fixed Setting	8 bit Process Mode	8 Bit Processing Mode	8001H	
	Time-out Period	Time-out Period	8001H	
SM/SD Setting	Latch Setting	Advanced Settings	8001H	
		8 Bit Process Mode	8001H	
		Time-out Period	8001H	
		Header Setting Value	8001H	
	Terminator Setting Value	8001H		
	FX3 Series Compatibility	SM/SD for Compatible	8001H	

### ■MC Protocol

Item			Parameter No.	
Basic Settings	Communication Protocol Type	Communication Protocol Type	8002H	
	Advanced Settings	Data Length		8002H
		Parity Bit		8002H
		Stop Bit		8002H
		Baud Rate		8002H
		Sum Check Code		8002H
Fixed Setting	Station Number	Station Number	8002H	
	Message Pattern	Message Pattern	8002H	
	Time-out Period	Time-out Period	8002H	
	Message waiting time	Message waiting time	8002H	
SM/SD Setting	Latch Setting	Advanced Settings	8002H	
		Station Number	8002H	
		Message Pattern	8002H	
		Time-out Period	8002H	
	Message waiting time	8002H		
	FX3 Series Compatibility	SM/SD for Compatible	8002H	

A

## ■MODBUS\_RTU Communication

Item			Parameter No.
Basic Settings	Communication Protocol Type	Communication Protocol Type	8003H
	Advanced Settings	Parity Bit	8003H
		Stop Bit	8003H
		Baud Rate	8003H
Fixed Setting	Host Station No.	Host Station No.	8003H
	Slave Response Timeout	Slave Response Timeout	8003H
	Broadcast Delay	Broadcast Delay	8003H
	Message to Message Delay	Message to Message Delay	8003H
	Timeout Retry Count Setting	Timeout Retry Count Setting	8003H
Modbus Device Assigned	Modbus Device Assigned	Device Assigned	8003H
SM/SD Setting	Latch Setting	Advanced Settings	8003H
		Host Station No.	8003H
		Slave Response Timeout	8003H
		Broadcast Delay	8003H
		Message to Message Delay	8003H
		Timeout Retry Count Setting	8003H
	FX3 Series Compatibility	SM/SD for Compatible	8003H

## ■Predefined Protocol Support Function

Item			Parameter No.
Basic Settings	Communication Protocol Type	Communication Protocol Type	8004H
	Advanced Settings	Data Length	8004H
		Parity Bit	8004H
		Stop Bit	8004H
		Baud Rate	8004H

## ■Inverter Communication

Item			Parameter No.
Basic Settings	Communication Protocol Type	Communication Protocol Type	8005H
	Advanced Settings	Data Length	8005H
		Parity Bit	8005H
		Stop Bit	8005H
		Baud Rate	8005H
Fixed Setting	Response Waiting Time	Response Waiting Time	8005H
SM/SD Setting	Latch Setting	Advanced Settings	8005H
		Response Waiting Time	8005H
	FX3 Series Compatibility	SM/SD for Compatible	8005H

## ■N:N Network

Item			Parameter No.
Basic Settings	Communication Protocol Type	Communication Protocol Type	8006H
Fixed Setting	Host Station No.	Host Station No.	8006H
	Total Number of Local Station	Total Number of Local Station	8006H
	Refresh Range	Refresh Range	8006H
	Timeout Retry Count Setting	Timeout Retry Count Setting	8006H
	Monitoring Time	Monitoring Time	8006H
Link Device	Link Device Bit	Device	8006H
	Link Device Word	Device	8006H
SM/SD Setting	Latch Setting	Host Station No.	8006H
		Total Number of Local Station	8006H
		Refresh Range	8006H
		Timeout Retry Count Setting	8006H
	Monitoring Time	8006H	
	FX3 Series Compatibility	SM/SD for Compatible	8006H

## ■Parallel Link

Item			Parameter No.
Basic Settings	Communication Protocol Type	Communication Protocol Type	8007H
Fixed Setting	Station Setting	Station Setting	8007H
	Link Mode	Link Mode	8007H
	Error Judgement Time	Error Judgement Time	8007H
Link Device	Link Device Bit	Device	8007H
	Link Device Word	Device	8007H
SM/SD Setting	Latch Setting	Station Setting	8007H
		Link Mode	8007H
		Error Judgement Time	8007H
		FX3 Series Compatibility	SM/SD for Compatible

A

## High Speed I/O Settings

Item			Parameter No.
Input Function	General/Interrupt/Pulse catch	General/Interrupt/Pulse catch	8010H
	High Speed Counter	High Speed Counter	8010H
	Pulse Width Measurement	Pulse Width Measurement	8010H
Output Function	Positioning	Positioning	8010H
	PWM	PWM	8010H
Input Check	Input Response Time	Input Response Time	8010H
	Input Interrupt	Rising	8010H
		Falling	8010H
		Rising+Falling	8010H
	Pulse Catch	Pulse Catch	8010H
	High Speed Counter	CH1 to 8	8010H
	Pulse Width Measurement	CH1 to 4	8010H
	Positioning	External Start Signal Positive Logic (Axis 1 to 4)	8010H
		External Start Signal Negative Logic (Axis 1 to 4)	8010H
		Interrupt Input Signal 1 High Speed (Axis 1 to 4)	8010H
		Interrupt Input Signal 1 Standard Positive Logic (Axis 1 to 4)	8010H
		Interrupt Input Signal 1 Standard Negative Logic (Axis 1 to 4)	8010H
		Near-point Dog Signal (Axis 1 to 4)	8010H
		Zero Signal Positive Logic (Axis 1 to 4)	8010H
Zero Signal Negative Logic (Axis 1 to 4)		8010H	
Interrupt Input Signal 2 (Axis 1 to 4)	8010H		
Output Confirmation	Positioning	Pulse Output (PULSE) (Axis 1 to 4)	8010H
		Pulse Output (SIGN) (Axis 1 to 4)	8010H
		Pulse Output (CW) (Axis 1 to 4)	8010H
		Pulse Output (CCW) (Axis 1 to 4)	8010H
		Clear Signal (Axis 1 to 4)	8010H
	PWM	CH1 to 4	8010H

### ■General/Interrupt/Pulse catch

Item			Parameter No.
General/Interrupt/Pulse Catch	General/Interrupt/Pulse Catch Setting	X0 to X17	8010H



## ■High Speed Counter

Item			Parameter No.	
Basic Settings	Use/Do Not Use Counter	Use/Not Use	8010H	
	Operation Mode	Operation Mode	8010H	
	Pulse Input Mode	Pulse Input Mode	8010H	
	Preset Input	Preset Input Enable/Disable		8010H
		Input Logic		8010H
		Preset Value		8010H
		Input Comparison Enable/Disable		8010H
		Control Switch		8010H
	Enable Input	Enable Input Enable/Disable		8010H
		Input logic		8010H
	Ring Length Setting	Ring Length Enable/Disable		8010H
		Ring Length		8010H
	Measurement Unit Time	Measurement Unit Time		8010H
Pulse No. of per Rotation	Pulse No. of per Rotation		8010H	
High Speed Compare Table	Counter CH	—	8010H	
	Comparison Type	—	8010H	
	Output Destination Device	—	8010H	
	Comparison Value 1 Specification Method	—	8010H	
	Comparison Value 1 Direct	—	8010H	
	Comparison Value 1 Indirect	—	8010H	
	Comparison Value 2 Specification Method	—	8010H	
	Comparison Value 2 Direct	—	8010H	
	Comparison Value 2 Indirect	—	8010H	
Multi-point Output High Speed Compare Table	Enable/Disable	—	8010H	
	Device	—	8010H	
	Comparison Value	—	8010H	
	Output Device	—	8010H	
	Output Data (HEX)	—	8010H	
	Table Data/Counter CH/Output Data/Points	—	8010H	
Occupied input (X) Explanation	1-Phase 1 Count (S/W Updown Switch)	CH1 to 8	8010H	
	1-Phase 1 Count (H/W Updown Switch)	CH1 to 8	8010H	
	1-Phase 2 Input	CH1 to 8	8010H	
	2-Phase 2 Counts	CH1 to 8	8010H	
Other	Specification method for high speed counter	Specification method for high speed counter	8010H	

## ■Pulse Width Measurement

Item			Parameter No.
Basic Settings	Use Pulse Width Measurement	Use/Not Use	8010H
	Input Signal	Input Signal	8010H
	Logical Switch	Logical Switch	8010H
	Measurement Mode	Measurement Mode	8010H

## ■Positioning

Item		Parameter No.	
Basic Settings	Basic Parameters 1	Pulse Output Mode	8010H
		Output Device (PULSE/CW)	8010H
		Output Device (SIGN/CCW)	8010H
		Rotation Direction Setting	8010H
		Unit Setting	8010H
		Pulse No. of per Rotation	8010H
		Movement Amount per Rotation	8010H
		Position Data Magnification	8010H
	Basic Parameters 2	Interpolation Speed Specified Method	8010H
		Max. Speed	8010H
		Bias Speed	8010H
		Acceleration Time	8010H
		Deceleration Time	8010H
	Detailed Setting Parameter	External Start Signal Enable/Disable	8010H
		External Start Signal Device No.	8010H
		External Start Signal Logic	8010H
		Interrupt Input Signal 1 Enable/Disable	8010H
		Interrupt Input Signal 1 Mode	8010H
		Interrupt Input Signal 1 Device No.	8010H
		Interrupt Input Signal 1 Logic	8010H
		Interrupt Input Signal 2 Logic	8010H
	OPR Parameters	OPR Enable/Disable	8010H
		OPR Direction	8010H
		Starting Point Address	8010H
		Clear Signal Output Enable/Disable	8010H
		Clear Signal Output Device No.	8010H
		OPR Dwell Time	8010H
		Near-point Dog Signal Device No.	8010H
		Near-point Dog Signal Logic	8010H
		Zero Signal Device No.	8010H
		Zero Signal Logic	8010H
		Zero Signal OPR Zero Signal Counts	8010H
		Zero Signal Count Start Time	8010H
Axis Common Parameter	When Stop Error Occurs, All Module Reset Enabled/Disabled	8010H	
Positioning Data	Device	—	8010H
	Control Method	—	8010H
	Axis to be Interpolated	—	8010H
	Positioning Address	—	8010H
	Command Speed	—	8010H
	Dwell Time	—	8010H
	Interrupt Counts	—	8010H
	Interrupt Input Signal 2 Device No.	—	8010H
	Jump Destination Table No.	—	8010H
	M No. for Jump Condition	—	8010H
	Table Data	—	8010H

## ■PWM

Item			Parameter No.
Basic Settings	Use PWM Output	Use/Not Use	8010H
	Output Signal	Output Signal	8010H
	Pulse Width/Cycle Unit	Pulse Width/Cycle Unit	8010H
	Output Pulse Logic	Output Pulse Logic	8010H
	Pulse Width	Pulse Width	8010H
	Cycle	Cycle	8010H

## Input Response Time Setting

Item			Parameter No.
Input Response Time	X0 to X577	—	8011H

## Analog Input Setting

Item			Parameter No.
Basic Settings	A/D Conversion Enable/Disable Setting Function	A/D Conversion Enable/Disable Setting	8014H
	A/D Conversion Method	Average Processing Specify	8014H
		Time Average Counts Average Moving Average	8014H
Application Settings	Warning Output Function	Process Alarm Warning Setting	8014H
		Process Alarm Upper Upper Limit Value	8014H
		Process Alarm Upper Lower Limit Value	8014H
		Process Alarm Lower Upper Limit Value	8014H
		Process Alarm Lower Lower Limit Value	8014H
	Over Scale Detection	Over Scale Detection Enable/Disable	8014H
	Scaling Setting	Scaling Enable/Disable	8014H
		Scaling Upper Limit Value	8014H
		Scaling Lower Limit Value	8014H
Shift Function	Shift Amount	8014H	
Digital Clip Setting	Digital Clip Enable/Disable	8014H	

## Analog Output Setting

Item			Parameter No.
Basic Settings	D/A Conversion Enable/Disable Setting Function	D/A Conversion Enable/Disable Setting	8015H
	D/A Output Enable/Disable Setting	D/A Output Enable/Disable Setting	8015H
Application Settings	Warning Output Function	Warning Output Setting	8015H
		Warning Upper Limit Value	8015H
		Warning Lower Limit Value	8015H
	Scaling Setting	Scaling Enable/Disable	8015H
		Scaling Upper Limit Value	8015H
		Scaling Lower Limit Value	8015H
	Shift Function	Shifting Amount	8015H
	Analog Output HOLD/CLEAR Setting	HOLD/CLEAR Setting	8015H
		HOLD Setting Value	8015H

## Extended Board Setting

Item			Parameter No.
Basic Settings	Extended Board	—	7000H
	Communication Protocol Type	—	*1

\*1 The parameter No. varies according to the communication protocol type. For details, refer to  Page 899 485 Serial Port.

# Memory card parameters

Item			Parameter No.
Boot Setting	Boot Setting	Clear the CPU built-in memory before boot	2000H
		Boot File Setting	2000H
	Setting of File/Data Use or Not in Memory Card	Module Extended Parameter	2010H
		Device Station Parameter	2010H

# Appendix 6 Event List

Information including errors detected in the CPU module, expansion board, expansion adapter and intelligent module, and errors that occur in the network are collected and saved in the CPU built-in memory or SD memory card by the CPU module. (Page 130 Event History Function) When an event occurs, its event code and details can be read by using an engineering tool.

Check the User's Manual of each module for a list of events related to the intelligent function module.

## How to read the event list

The event list contains the following information.

Item	Description
Event code	ID number assigned to an event
Event type	Type of an event
Event category	Category of an event
Detected event	Description of a detected event
Detailed information 1 to 3	Details of a detected event

## Detailed information

The following table lists the details of information displayed in the detailed information 1 to 3.

Detailed information	Item	Description
Detailed information 1	Operation source information	Information on the operation source <ul style="list-style-type: none"><li>• Connection port (Connection information such as Ethernet)</li><li>• Module number</li><li>• Network number</li><li>• Station number</li><li>• IP address</li></ul>
	Event history file information	Information on the event history file
Detailed information 2	Communication speed and communication mode	Information on the communication speed and the communication mode
	Drive/file information	Information on the corresponding drive name and file name
	Device/label information	Information on the corresponding device and label
Detailed information 3	—	—

# Event list

The following table lists events related to the CPU module.

Event code	Event type	Event category	Detected event	Description	Detailed information		
					Detailed information 1	Detailed information 2	Detailed information 3
00430	System	Info	SFC program continue start not possible	An SFC program could not be resumed, and an initial start was performed.	—	—	—
00800		Warning	Link-down	The CPU module has entered into the link-down state as a result of an operation such as disconnecting a network cable between the CPU module and an external device.	Operation source information	Communication speed and communication mode	—
00904			Socket communication send error	Sending a message over socket communication failed.			
01000 and after		Error	When a self-diagnostic error occurs, the error is stored as an event.				
10100	Security	Info	Security key registration/deletion	A security key was registered or deleted.	Operation source information	Security key operation information	—
10200			Remote password lock	The remote password was set.			
10201			Remote password unlock	The remote password unlock processing was successfully completed.			
10202			Remote password unlock failed	The remote password unlock processing failed.			
10300			Access from an IP address blocked by the IP filter setting	An access from an IP address blocked by the IP filter setting was accepted.			
10400			File password registration/change/deletion	A file password was successfully registered, changed, or deleted.			
10401			File password registration/change/deletion failed	Registration, change, or deletion of a file password failed.			
10402			File password unlock	A file password was successfully unlocked.			
10403			File password unlock failed	Unlock of a file password failed.			
20100	Operation	Info	Error clear	The error was cleared.	Operation source information	—	—
20200			Event history clear	The event history was cleared.			
20210			Scan time clear	The scan time was cleared.			
20400			Firmware update successful via SD memory card	CPU module firmware update using the SD memory card was performed and completed successfully.	CPU module firmware update information		
20401			Firmware update failed via SD memory card	CPU module firmware update using the SD memory card was performed and was not completed successfully.			
24000			Clock setting	The clock data was set.	Operation source information		
24001		Remote operation request accepted	A remote request (RUN, STOP, or PAUSE) was accepted.	Remote operation type information			
24200		Creation of new folders, writes to files/folders	A new folder was created. A new file was created or data was written to a file.			Drive/file information	
2A200		Warning	Memory initialization	The memory was initialized.		Drive/file information	
2A201			Device/label zero clear	Values in a device or label were cleared to zero.		Device/label information	
2A202			Folder/file deletion	A folder or file was deleted.		Drive/file information	

# Appendix 7 Processing Time

Each of the processing time that constitutes the scan time is as follows.

## SFC program processing time

This section describes the time required for SFC program processing. For details on the SFC program, refer to the following.  
 MELSEC iQ-F FX5 Programming Manual (Program Design)

### SFC program processing performance

The SFC program execution time can be calculated with the following formula.

- SFC program execution time = (A) + (B) + (C)

Item	Description	
(A)	SFC processing time	Page 909 SFC processing time
(B)	Operation output processing time for all steps	This is the total processing time for each instruction used for operation output for all steps in the active status.
(C)	Processing time for all transition conditions	This is the total processing time for each instruction used for transition conditions associated with each step in the active status.

For the processing time for the SFC control instruction, refer to the following.

MELSEC iQ-F FX5 Programming Manual (Instructions, Standard Functions/Function Blocks)

### ■SFC processing time

The following table lists the details of the types of the SFC processing time (A).

- The SFC processing time (A) = (a) + (b) + (c) + (d) + (e) + (f) + (g) + (h)

Item	Processing time calculation (unit: $\mu$ s)	Description
(a)	Active block processing time	Active block processing time coefficient $\times$ Number of active blocks This is the system processing time required to execute active blocks.
(b)	Inactive block processing time	Inactive block processing time coefficient $\times$ Number of inactive blocks This is the processing time required to execute inactive blocks.
(c)	Nonexistent block processing time	Nonexistent block processing time coefficient $\times$ Number of nonexistent blocks This is the system processing time required to execute blocks that have not been created.
(d)	Active step processing time	Active step processing time coefficient $\times$ Number of active steps This is the time required to execute active steps.
(e)	Active transition processing time	Active transition processing time coefficient $\times$ Number of active transitions This is the system processing time required to execute active transitions.
(f)	Transition establishment step processing time	Transition establishment step processing time coefficient $\times$ Number of transitions This is the time required to turn off active steps when transitions are established.
(g)	SFC END processing time	SFC END processing time This is the system processing time required for SFC END processing.
(h)	Operation output processing time	Action processing time coefficient $\times$ Number of actions This is the system processing time required to process operation outputs.



The following table lists the coefficient values for each processing time.

Item			Coefficient value		
			FX5U/FX5UC CPU module		
			Program capacity setting: 64000 steps	Program capacity setting: 128000 steps	
(a)	Active block processing time coefficient		2.6 $\mu$ s	2.6 $\mu$ s	
(b)	Inactive block processing time coefficient		1.2 $\mu$ s	1.2 $\mu$ s	
(c)	Nonexistent block processing time coefficient		0.5 $\mu$ s	0.5 $\mu$ s	
(d)	Active step processing time coefficient	FX3 Compatible Transition Operation Mode Enable	5.8 $\mu$ s	8.2 $\mu$ s	
		FX3 Compatible Transition Operation Mode Disable	5.4 $\mu$ s	7.7 $\mu$ s	
(e)	Active transition processing time coefficient		2.5 $\mu$ s	5.6 $\mu$ s	
(f)	Transition establishment step processing time coefficient	Hold step	FX3 Compatible Transition Operation Mode Enable	21.9 $\mu$ s	28.1 $\mu$ s
			FX3 Compatible Transition Operation Mode Disable	12.3 $\mu$ s	13.1 $\mu$ s
		Normal step	FX3 Compatible Transition Operation Mode Enable	22.9 $\mu$ s	29.2 $\mu$ s
			FX3 Compatible Transition Operation Mode Disable	17.6 $\mu$ s	22.1 $\mu$ s
(g)	SFC END processing time		2.4 $\mu$ s	2.4 $\mu$ s	
(h)	Operation output processing time coefficient		—	—	



# Processing time until the file operation is completed

This section describes the processing time from the start of the file operation instruction until the completion of the file operation.

## Changes in the processing time according to the number of files

The processing time changes according to the number of files stored in folders. The table below lists the processing time under the following conditions.

### Condition

- Folder/file structure (drive 2: SD memory card)
- SD memory card: NZ1MEM-2GBSD used
- Size of each file to be operated: 1K byte
- The following table lists the instruction arguments of each file operation instruction.

Instruction name	First argument	Second argument	Third argument	Fourth argument	Fifth argument	Sixth argument	Seventh argument
SP.FDELETE	U1	K2	D0	"D001"	M0	—	—
SP.FCOPY	U1	D40	K2	"D001"	K2	"D002"	M40
SP.FMOVE	U1	D40	K2	"D001"	K2	"D002"	M40
SP.FRENAME	U1	K2	D0	"D001"	"D002"	M0	—
SP.FSTATUS	U1	K2	D0	"D001"	D10	M0	—

- File/folder structures except those shown below do not exist.

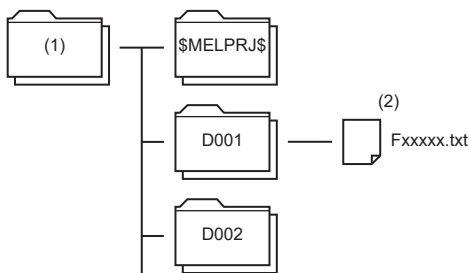

(1) Root directory (root folder)

(2) All file names are Fxxxx.txt (xxxxx: serial numbers starting from 00001).

- Overwriting setting: Not overwrite (SP.FCOPY, SP.FMOVE only)
- Target type setting (b0): Folder specification
- Target type setting (b2): Move the specified folder (SP.FMOVE only)
- Empty folder deletion setting: Delete folders even when they are not empty (SP.FDELETE only)

### Processing time (Constant scan: None)

Instruction name	Number of operated files in the folder (D001)		
	1	10	100
SP.FDELETE	261ms	1600ms	14380ms
SP.FCOPY	1614ms	15173ms	138573ms
SP.FMOVE	115ms	162ms	119ms
SP.FRENAME	34ms	35ms	37ms
SP.FSTATUS	3ms	4ms	6ms



## Changes in the processing time according to the file size

The processing time changes according to the size of the files stored in the folder. The table below lists the processing time under the following conditions.

### ■Condition

- Folder/file structure (drive 2: SD memory card)
- SD memory card: NZ1MEM-2GBSD used
- Number of files in the folder: 1
- The following table lists the instruction argument of each file operation instruction.

Instruction name	First argument	Second argument	Third argument	Fourth argument	Fifth argument	Sixth argument	Seventh argument
SP.FDELETE	U1	K2	D0	"D001\F00001.txt"	M0	—	—
SP.FCOPY	U1	D40	K2	"D001\F00001.txt"	K2	"D002"	M40
SP.FMOVE	U1	D40	K2	"D001\F00001.txt"	K2	"D002"	M40
SP.FRENAME	U1	K2	D0	"D001\F00001.txt"	"F00002.txt"	M0	—
SP.FSTATUS	U1	K2	D0	"D001\F00001.txt"	D10	M0	—

- File/folder structures except those shown below do not exist.

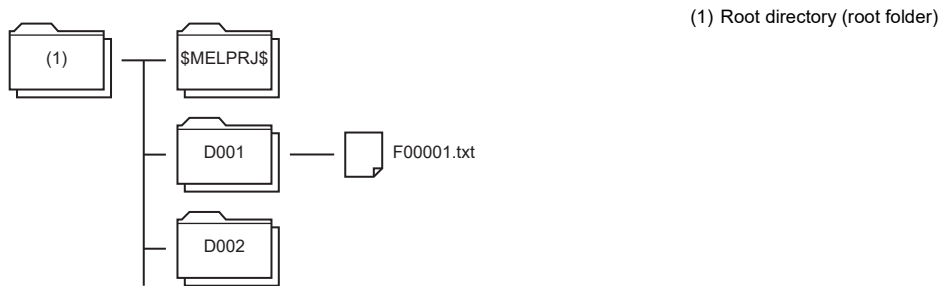

- Overwriting setting: Not overwrite (SP.FCOPY, SP.FMOVE only)
- Target type setting: Folder specification

### ■Processing time (Constant scan: None)

Instruction name	Number of operated files in the folder (D001)		
	100KB	1MB	16MB
SP.FDELETE	80ms	81ms	780ms
SP.FCOPY	2802ms	16289ms	285671ms
SP.FMOVE	216ms	216ms	216ms
SP.FRENAME	26ms	26ms	28ms
SP.FSTATUS	13ms	13ms	13ms

# Appendix 8 How to Use CPU Module Logging Configuration Tool

This appendix describes how to operate the CPU Module Logging Configuration Tool and configure the logging function.

## Point

For the system configuration and procedure for using the data logging function, refer to the following.

 Page 150 Procedure for Using

## Operating environment

For details on the operating environment for CPU Module Logging Configuration Tool, refer to following manual which is stored in the installer.

 CPU Module Logging Configuration Tool/GX LogViewer Installation Instructions (BCN-P5999-0506)

## Installation/uninstallation

For the procedures for installing and uninstalling the CPU Module Logging Configuration Tool, refer to the following.

 CPU Module Logging Configuration Tool/GX LogViewer Installation Instructions (BCN-P5999-0506)

## Starting the CPU Module Logging Configuration Tool

The CPU Module Logging Configuration Tool can be started by the following three methods.

### ■ Starting from the Start menu

After installing the CPU Module Logging Configuration Tool, you can start the tool by the following operation.

 [Start] ⇒ [All Programs] ⇒ [MELSOFT] ⇒ [Logging Function] ⇒ [CPU Module Logging Configuration Tool]

### ■ Starting from GX Works3

After starting GX Works3, you can start the tool by the following operation.

 [Tool] ⇒ [Logging Configuration Tool]

When the tool is started, the project information (connected device, transfer setup/setting, and display language) of GX Works3 is handed off.

### ■ Starting from GX LogViewer

Refer to the following manual.

 GX LogViewer Version 1 Operating Manual

## Point

If an error message is displayed when the CPU Module Logging Configuration Tool is started, start it with administrator privileges.

## Communication route

To connect the CPU module to a personal computer, use the following methods. (📄 Page 920 Transfer setup)

### ■ Connection through an RS-232C communication port

Connect the CPU module that is hooked up with an FX5-232-BD or FX5-232ADP with an RS-232C cable.

### ■ Connection through an USB port

Connect the FX5S/FX5UJ CPU module with a USB cable.

### ■ Connection through an Ethernet port

- Connection via a hub

Connect the CPU module via a hub to a personal computer on the same local network. Note that IP address of the CPU module must be specified. Also the personal computer should have the same network address as the CPU module.

### Restriction

Only local area network can be used for connections. Connections via the Internet are not allowed.

- Direct connection

One-to-one direct connection with an Ethernet cable is possible. This method requires no hub. Note that IP address of the CPU module need not be specified with this method.

## Precautions

- Do not directly connect to a personal computer via LAN line. Load imposed on the LAN line adversely affect communications of other devices.
- Do not configure the direct connection setting when using one-to-one connection via a hub between the CPU module and a personal computer.
- If the following conditions are met, the direct connection communication may be disabled. If the communication is disabled, review the settings of the CPU module and personal computer.

### Ex.

When all the bits of the CPU module-side IP address that correspond to 0 part of the personal computer-side subnet mask are ON or OFF:

CPU module-side IP address: 64.64.255.255

Personal computer-side IP address: 64.64.1.1

Personal computer-side subnet mask: 255.255.0.0

### Ex.

In the CPU module IP address bits, if the bits corresponding to the host address of the class of the personal computer IP address are all ON or all OFF:

Personal computer IP address: 192.168.0.1 ← 192.x.x.x., class C and the host address is the fourth octet.

Personal computer subnet mask: 255.0.0.0

CPU module IP address: 64.64.255.255 ← each bit turns on because of the fourth octet is 255

### Point

The IP address for each class is as follows.

- Class A: 0.x.x.x to 127.x.x.x
- Class B: 128.x.x.x to 191.x.x.x
- Class C: 192.x.x.x to 223.x.x.x

The host address for each class is the portion including "0" as shown below.

- Class A: 255.0.0.0
- Class B: 255.255.0.0
- Class C: 255.255.255.0

# Screen configuration

## Entire screen

The entire screen configuration is shown below.

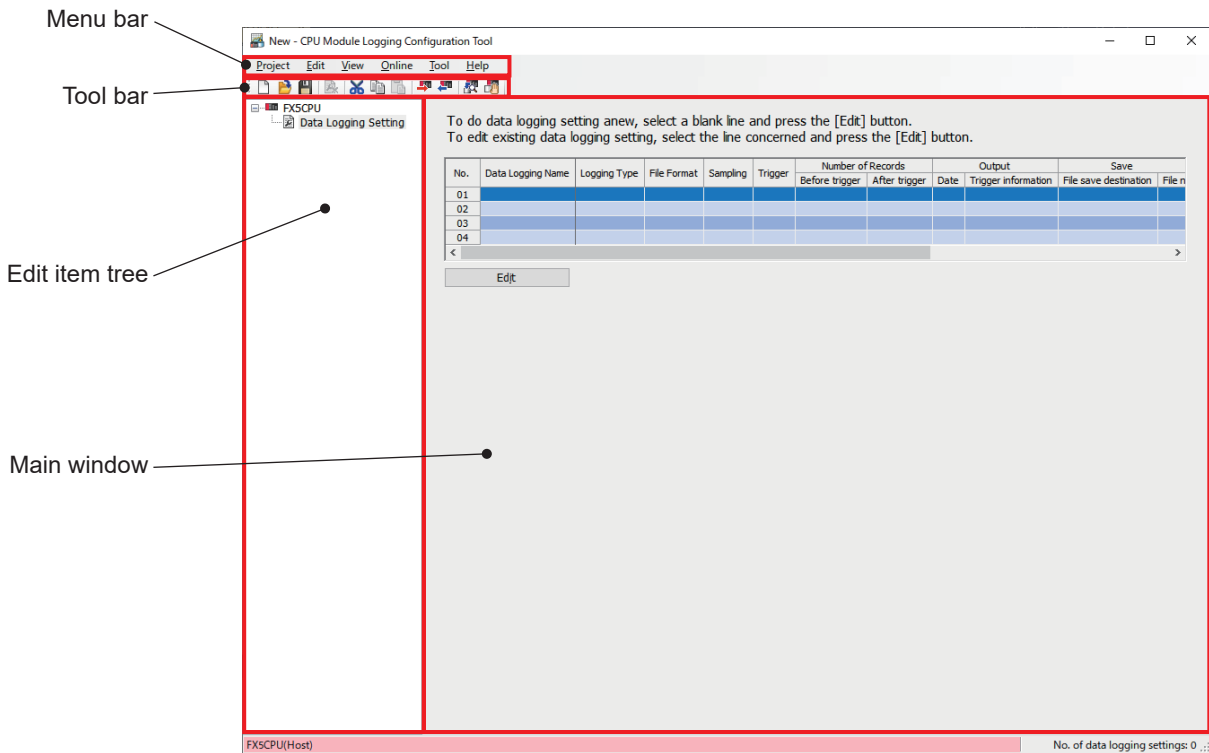

Name	Description	Reference
Menu bar	The menu is displayed.	Page 916 Menu structure
Tool bar	The tool icons are displayed.	—
Edit item tree	The setting items are displayed in tree format.	—
Main window	Set the items necessary for using the data logging function in the wizard window.	Page 927 Setting data logging

A

# Menu structure

The following table describes the menu structure of CPU Module Logging Configuration Tool.

Menu item		Description	Reference
Project	New	Create a new project.	Page 917
	Open	Open a stored project file.	Page 917
	Save	Overwrite an edited project to the file and saves it.	Page 917
	Save As	Save an edited project with a new file name.	Page 917
	Read Logging Setting from Memory Card (SD)	Read the data logging setting written in the SD memory card attached to the personal computer.	Page 918
	Write Logging Setting into Memory Card (SD)	Write the settings being edited in a format with which the CPU module can operate. The settings are directly written into an SD memory card attached to the personal computer.	Page 919
	Recent Files	Open a recently used file.	—
	Exit	Exit CPU Module Logging Configuration Tool.	—
Edit	Delete Data Logging Setting	Remove the data logging setting selected in the Edit item tree.	—
	Copy and Add Data Logging Setting	Copy and add the data logging setting selected in the Edit item tree.	—
	Batch Data Insertion	Configure the multiple setting items at once.	—
	Cut Setting Item	Delete the data in the selected row and copy the setting items to the clip board. <sup>*1</sup>	—
	Copy Setting Item	Copy the setting items in the selected row to the clip board. <sup>*1</sup>	—
	Paste Setting Item	Paste the copied setting items to the selected row. <sup>*2</sup>	—
	Insert and Paste Setting Items <sup>*3</sup>	If "Insert and Paste Setting Items" is executed in the state where the setting items are copied/cut, the setting items in the clip board will be inserted above the selected row. <sup>*2</sup>	—
	Delete Setting Item	Delete the setting items in the selected row.	—
	Move Setting Item Upward	Move the setting items in the selected row upward.	—
	Move Setting Item Downward	Move the setting items in the selected row downward.	—
	Device Batch Replacement	Replace devices for all the settings.	—
View	Switch Display Language (Display Language)	Change the display language for menus and so on.	Page 920
Online	Transfer Setup	Configure the communication setting used for connection to the CPU module.	Page 920
	Read Logging Setting	Read the setting from the CPU module.	Page 921
	Write Logging Setting	Write the setting to the CPU module.	Page 922
	Delete Logging Setting	Remove the setting data from the CPU module.	Page 923
	Logging Status and Operation	Check the data logging status.	Page 924
	Logging File Operation	Connect to the CPU module and reads or removes the files on the attached SD memory card.	Page 926
Tool	Start GX LogViewer	Launch GX LogViewer.	Page 913
Help	Open Manual	E-Manual Viewer opens and its manual is displayed.	Page 927
	Connection to MITSUBISHI ELECTRIC FA Global Website	The Mitsubishi Electric Corporation FA website is displayed.	Page 927
	About Configuration tool	The product information is displayed.	Page 927

\*1 Even if the copied/cut setting items are edited or the screen is switched, the items are still in a copied state. They can be pasted while the copied data is in the clip board.

\*2 The setting items copied by using the watch window of GX Works3 or GX Works2, spreadsheet software or text editor can be pasted.

\*3 "Insert Copied Setting Item" and "Insert Cut Setting Item" were changed to "Insert and Paste Setting Items". The version of the CPU Module Logging Configuration Tool with the updated menu is 1.118X.

## Project management

This function creates and saves the project, and reads/writes it from/to an SD memory card.

### ■New

Create a new project.

 [Project] ⇒ [New]

### Window

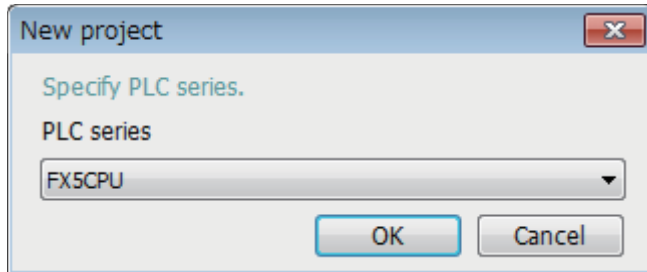

### Displayed items

Item	Description
PLC series	Select "FX5CPU".

### ■Open

Open a stored project file.

 [Project] ⇒ [Open]

### ■Save

Overwrite an edited project to the file and saves it.

 [Project] ⇒ [Save]

### ■Save as

Save an edited project with a new file name.

 [Project] ⇒ [Save as]

## ■Read logging setting from memory card (SD)

The following procedure is to read the data logging setting written in an SD memory card attached to the personal computer.

### Operating procedure

1. Attach an SD memory card to the personal computer.
2. Open the following window.  
 [Project] ⇒ [Read Logging Setting from Memory Card (SD)]
3. Select the drive from which data is read and data to be read.
4. Click the [Read] button.

### Window

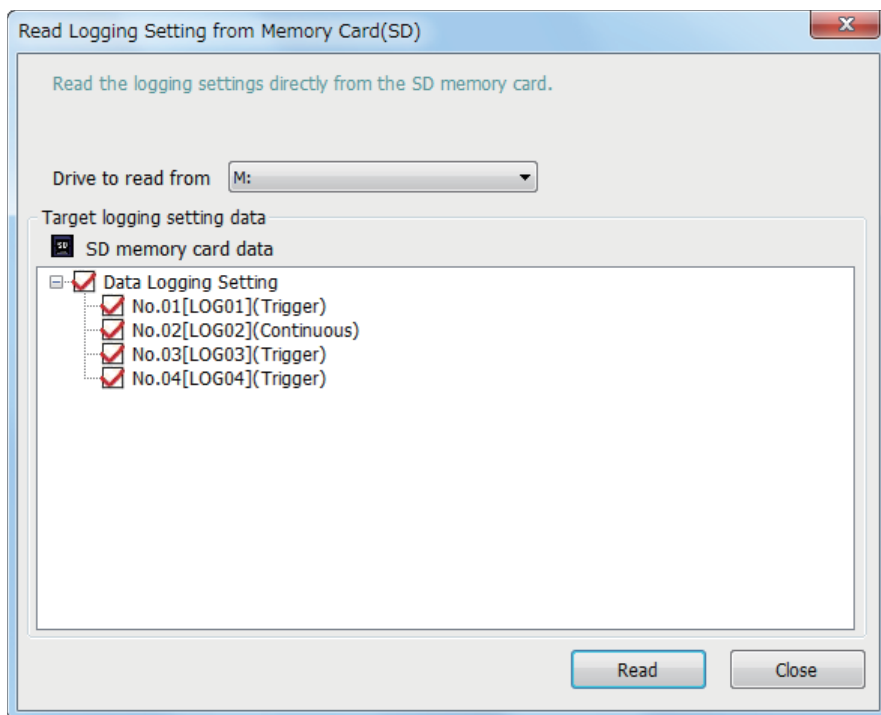

### Displayed items

Item	Description
Drive to read from	Select the drive where the data to be read is stored.
Target logging setting data	Select the data item to be read.

#### Point

Any existing data (data logging setting with the same setting number or common setting) on the target is overwritten.



## Write logging setting into memory card (SD)

The following procedure is to write the settings being edited in a format with which the CPU module can operate. Once writing the settings directly into an SD memory card attached to the personal computer and attaching the card to the CPU module, the data logging starts.

### Operating procedure

1. Attach an SD memory card to the personal computer.
2. Open the following window.  
 [Project] ⇒ [Write Logging Setting into Memory Card (SD)]
3. Select the drive to which data is written and data to be written.
4. Click the [Write] button.

### Window

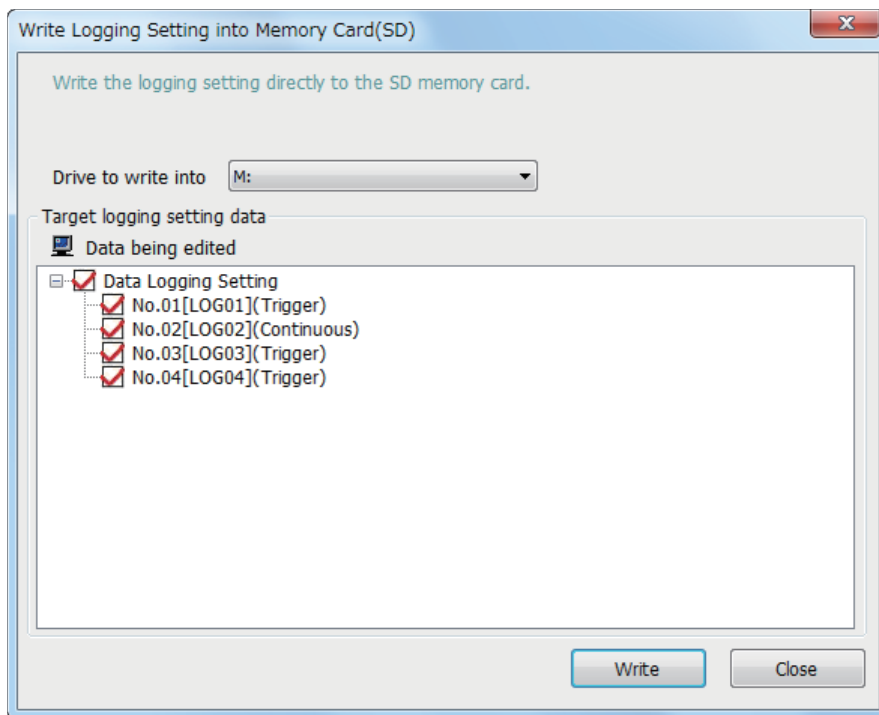

A

### Displayed items

Item	Description
Drive to write into	Select the drive where the data to be written is stored.
Target logging setting data	Select the data to be written.

#### Point

Any existing data (data logging setting with the same setting number or common setting) on the target is overwritten.

## View

### ■Display language change

The CPU Module Logging Configuration Tool supports multiple languages, and can be used by changing the display language for menus and so on at the same computer.

### Operating procedure

[View] ⇒ [Switch Display Language (Display Language)]

### Precautions

Text may be cut off if the OS and set display language differ.

## Online

The online operation enables users to read/write/remove the data logging settings, view the data logging status, and operate the data logging file.

### ■Transfer setup

The following window specifies the communication route between the CPU module and a personal computer.

 [Online] ⇒ [Transfer Setup]

### Window

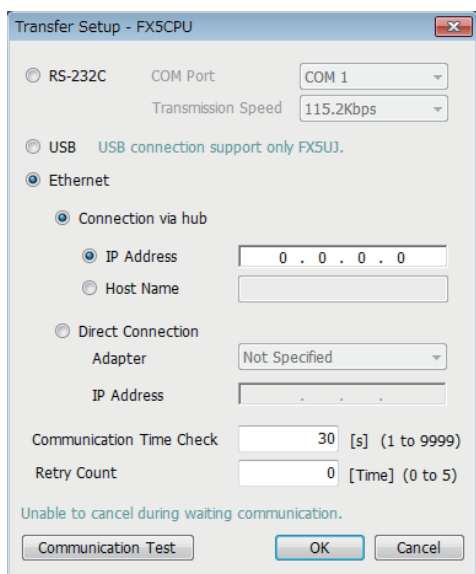

### Displayed items

Item	Description		
RS-232C	COM Port	Configure the COM port and transmission speed used for connection with an RS-232C communication cable. • COM Port: COM1 to COM63 • Transmission Speed: 9.6kbps / 19.2kbps / 38.4kbps / 57.6kbps / 115.2kbps	
	Transmission Speed		
USB*1	Configure when connecting with a USB cable.		
Ethernet	Connection via hub	IP Address	Configure the IP address and host name used for connection via a hub with an Ethernet cable.
		Host Name	
	Direct Connection	Adapter	For direct connection with the Ethernet cable, select the Ethernet adapter that is connected directly to the CPU module. The IP address of the selected Ethernet adapter is displayed as the IP address.
		IP Address	
Communication Time Check		Specify the communication time.	
Retry Count		Specify the number of retries.	
[Communication Test] button		This button checks the communication status.	

\*1 Only FX5UJ CPU module is supported.

## ■Read logging setting

The following procedure reads the data logging setting from the target memory.

### Operating procedure

1. Open the "Read Logging Setting" window.

 [Online] ⇒ [Read Logging Setting]

2. Select the memory where the data to be read is stored from the "Target memory" list.
3. Select the checkbox corresponding to the data item to be read in the "Target logging setting data" list, and click the [Read] button.

### Window

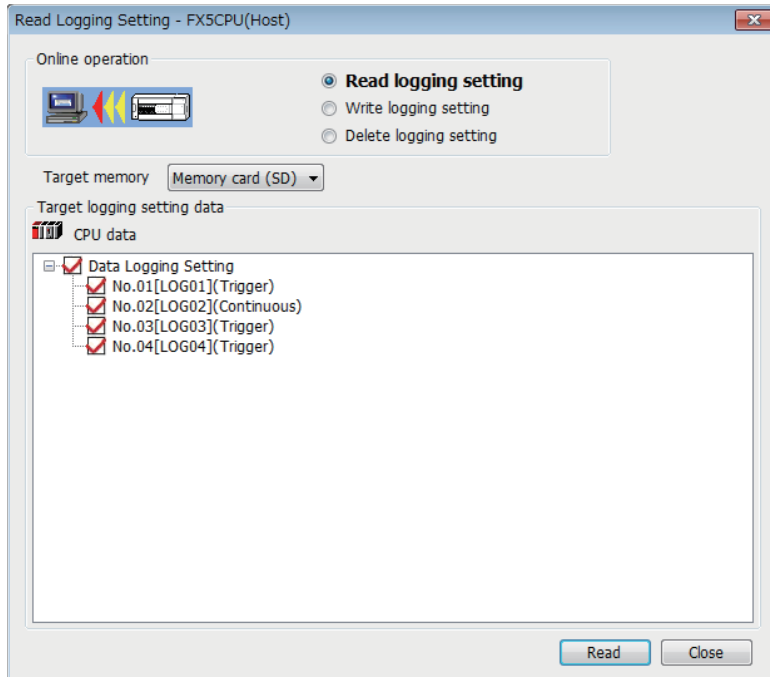

A

### Displayed items

Item	Description
Target memory	Select the memory where the data to be read is stored.
Target logging setting data	Select the data item to be read.

#### Point

Any existing data (data logging setting with the same setting number or common setting) on the target is overwritten.

## ■ Write logging setting

The following procedure is to write the data logging setting to the target memory.

### Operating procedure

1. Open the "Write Logging Setting" window.

 [Online] ⇄ [Write Logging Setting]

2. Select the memory where the data to be written is stored from "Target memory" list.
3. Select the checkbox in the "Target logging setting data" list corresponding to the data item to be written, and click the [Write] button.

### Setting data

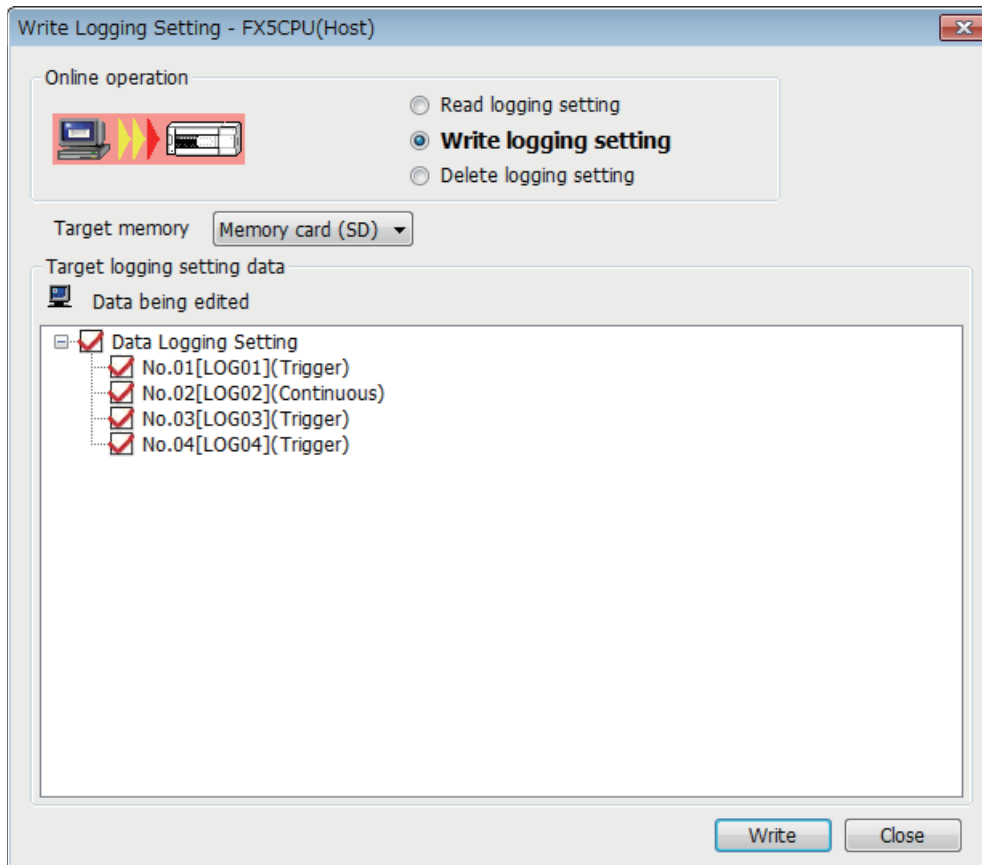

### Displayed items

Item	Description
Target memory	Select the memory where the data to be written is stored.
Target logging setting data	Select the data to be written.

#### Point

Any existing data (data logging setting with the same setting number or common setting) on the target is overwritten.

## ■Delete logging setting

The following procedure removes the data logging setting on the target memory.

### Operating procedure

1. Open the "Delete Logging Setting" window.

 [Online] ⇨ [Delete Logging Setting]

2. Select the memory where the data to be removed is stored from the "Target memory" list.

3. Select the checkbox corresponding to the data item to be removed in the "Target logging setting data" list, and click the [Delete] button.

### Window

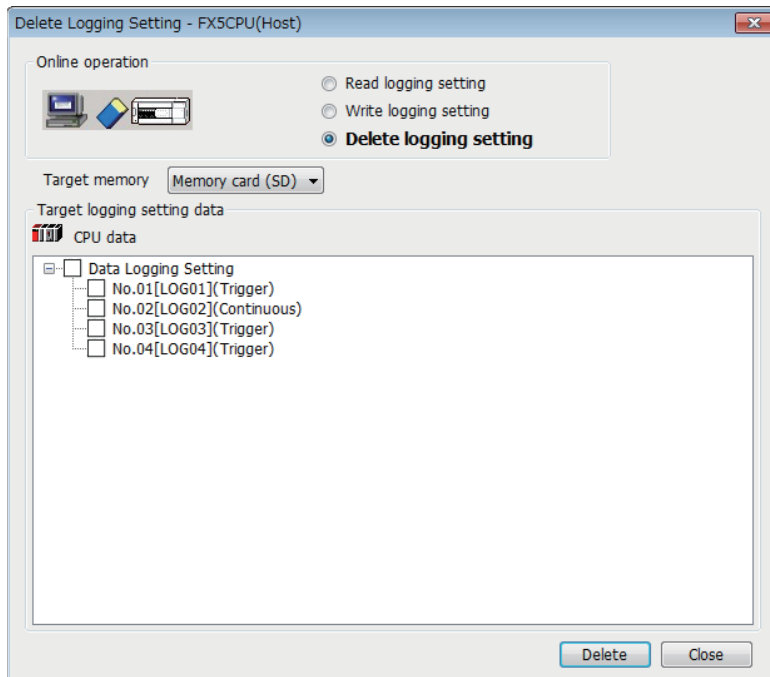

A

### Displayed items

Item	Description
Target memory	Select the memory where the data to be removed is stored.
Target logging setting data	Select the data to be removed.

## ■ Logging status and operation

The following procedure is to execute or stop the data logging. Also the data logging status can be checked through this procedure.

### Operating procedure

1. Open the "Logging Status and Operation" window.  
 [Online] ⇒ [Logging Status and Operation]
2. Specify the target memory (either data memory or SD memory card) where the effective setting data is stored.
3. Select the checkbox corresponding to the setting number to be executed (Multiple selection possible)
4. Start the data logging by clicking the [Start] button. (When multiple items are selected, they are executed simultaneously.)
5. To suspend data logging, click the [Pause] button. To stop data logging, click the [Stop] button. (When multiple items are selected, they are executed simultaneously.)

### Point

- The data logging cannot be started even when writing the setting and turning power off and on or resetting. Be sure to click the [Start] button to start data logging.
- With regards to the trigger logging, the data logging setting registration attempt fails if the trigger condition is satisfied.
- It takes a certain time to stop or suspend the data logging after either of these commands is issued by CPU Module Logging Configuration Tool (because the data logging is not stopped or suspended unless the data stored in the internal buffer data has been transferred into the SD memory card in response to these commands).
- There may be a case where a time-out error occurs and the data logging is suspended after CPU Module Logging Configuration Tool starts the logging.

## Window

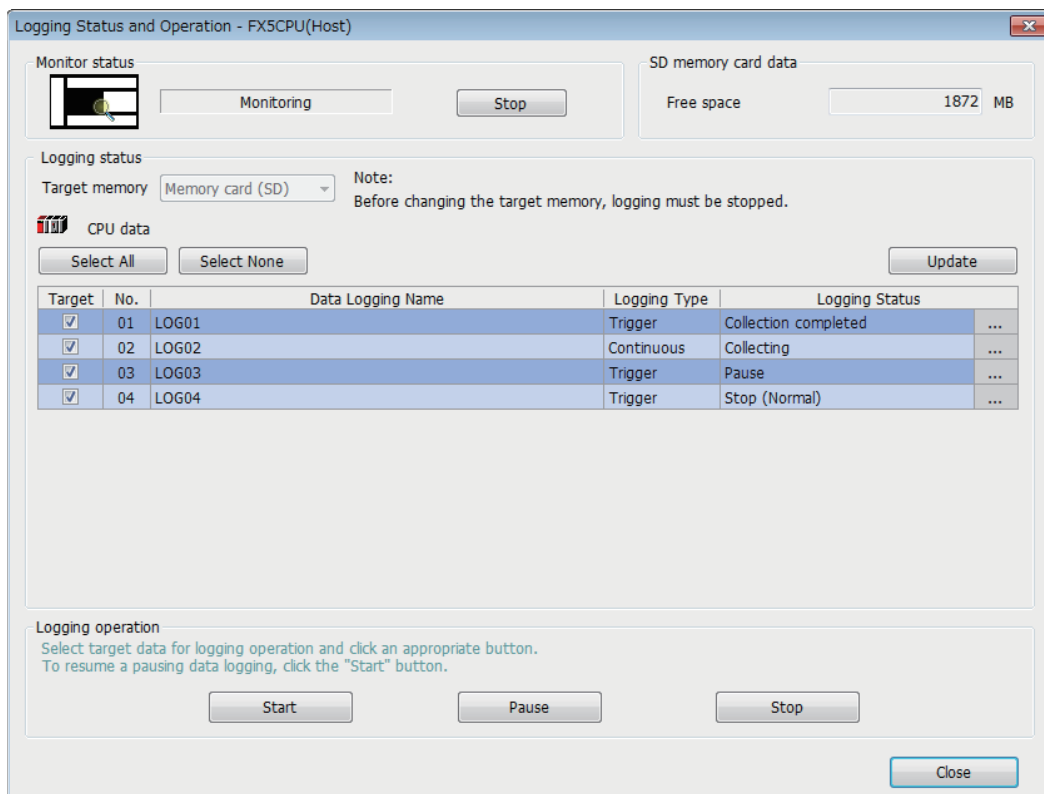

## Displayed items

Item		Description
Monitor status	[Start (Stop)] button	Start or stop monitoring.
SD memory card data	Free space	View the amount of free space of the SD memory card.
Logging status	Target memory	Select the memory used for this operation.*1
	[Select All] button	Select all the checkboxes in the setting data list.
	[Select None] button	Clear all the checkboxes in the setting data list.
	[Update] button	Update monitoring status.
	Target	Select the target setting data for this operation (Multiple selection possible)
	[...] button	Clicking this button when an error occurs displays the error details window.
Logging operation	[Start] button	Execute the logging of the selected setting data.
	[Pause] button	Suspend the logging of the selected setting data.
	[Stop] button	Stop the logging of the selected setting data.

\*1 This menu item can be selected only when all the data logging statuses are "Stop".

The data logging function has various states that can be classified into data logging and storage.

### • Data logging states

Data logging states	Description
Stop	No data logging settings are registered and data collection is inactive.
Waiting RUN Not collected	Data collection has not yet begun because the CPU module is not in the RUN mode.
Waiting start Not collected	Data collection has not yet begun because waiting for the start command.
Pause	Data logging is suspended and data collection is inactive.
Waiting to establish collection conditions Not collected	Waiting for the first collection timing after the start command.
Collecting	Continuous logging is active and collecting data.
Waiting trigger Collecting before trigger	Trigger logging is active and collecting data, waiting until the trigger condition is met.
Collecting after trigger	Trigger logging is active and collecting data after the trigger condition is met.
Collection completed	Continuous logging: Data collection has finished upon reaching "Number of files to be saved" specified as part of the "Stop" setting configured in "Operation when exceeds the number of files". Trigger logging: Has finished collecting as much data as the specified number of records.
Error	Data logging has failed due to the occurrence of an error.

### • Storage states

Storage states	Description
Unsaved	Has not yet stored the collected data into the SD memory card.
Saving in progress	Has begun but not yet finished storing the collected data into the SD memory card.
Save completed	Has finished storing the collected data as much as the specified number of records into the SD memory card.*1

\*1 If the data logging function has not yet collected and stored as much data as the specified number of records (i.e., either data logging has been stopped or suspended before collecting or storing the specified number of records or the CPU module has been stopped), it completes the storage operation by storing all the data that has been collected into the internal buffer. It does not store data, however, before the trigger condition is met.

## ■ Logging file operation

The following procedure is to save or remove data logging files on an SD memory card from/to the personal computer.

### Operating procedure

1. Open the "Logging File Operation" window.  
 [Online] ⇒ [Logging File Operation]
2. Specify the directory and select the targeted file.
3. To save, click the [Save to PC] button. To delete, click the [Delete] button.

### Point

Attempting the following operations may result in delay of other monitor update because a certain time period is required for saving data logging files.

- When saving data logging files during the data logging execution.
- When saving a large data logging file.

### Window

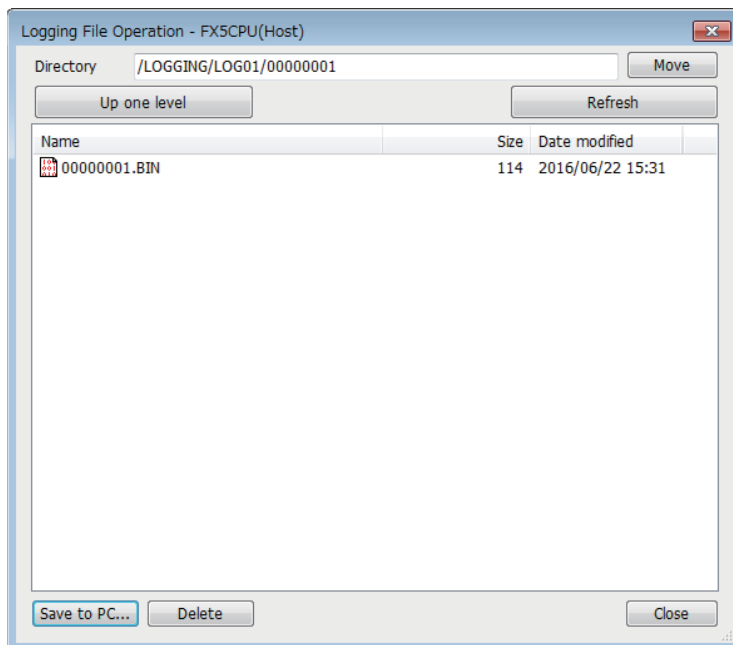

### Displayed items

Item	Description
Directory	View the path to the displayed folder. To change the folder, specify the target folder path.
[Move] button	Move to the specified folder.
[Up one level] button	Move up to a higher level in the folder hierarchy.
[Refresh] button	Update the displayed content.
[Save to PC] button	Display the "Save As" window and save the selected file to the personal computer.
[Delete] button	Remove the selected file or folder.



## Help

The following procedures allow to view or use the help function of CPU Module Logging Configuration Tool.

### ■Opening user's manual

E-Manual Viewer opens and its manual is displayed.

#### Operating procedure

 [Help] ⇒ [Open Manual]

### ■Connection to MITSUBISHI ELECTRIC FA Global Website

Access Mitsubishi Electric Corporation FA site home page.

#### Operating procedure

 [Help] ⇒ [Connection to MITSUBISHI ELECTRIC FA Global Website]

### ■Checking version information

Check the version of CPU Module Logging Configuration Tool.

#### Operating procedure



 [Help] ⇒ [Version Information]

## Setting data logging

This menu item launches a wizard that helps users to configure the required settings for using the data logging function.

 Edit item tree ⇒ [FX5CPU] ⇒ [Data Logging Setting] ⇒ [Edit] button

## Logging type

The following window configures the data logging type ( Page 163 Logging type,  Page 169 Data output specifications).

A

### Window

Logging type > | Sampling > | Data > | Output > | Save > | Movement > | Finish

First off, select a logging type.

**Logging type**  
Select a logging type.

- Continuous logging**  
Logging is carried out continuously at the specified data sampling intervals. Interval at which or conditions under which to carry out logging can also be specified.
- Trigger logging**  
By monitoring data, data before and after a condition held true is logged.

**File format**  
Select the file format which outputs the logging.

- CSV file**  
The data can be checked not only by GX LogViewer but also by text editor or table calculation soft.
- Binary file**  
The data in the file can be checked by GX LogViewer. Compare with CSV file, the file volume can be decreased. Select the binary file when GX Works3 offline monitor (logging) function is used.

### Displayed items

Item	Description	Setting range	Default
Logging type	Select the logging type.	<ul style="list-style-type: none"><li>• Continuous logging</li><li>• Trigger logging</li></ul>	Continuous logging
File format	Select the output file format. (  Page 169 Data logging file)	<ul style="list-style-type: none"><li>• CSV file</li><li>• Binary file</li></ul>	Binary file

## Collection

The following window configures the collection interval and/or collection start conditions (☞ Page 165 Data collection conditions)

### Window

Logging type > **Sampling** > Data > Output > Save > Movement > Finish

Specify the sampling interval and start conditions.

Sampling interval

Each scanning cycle  
Samples data at each sequence scanning cycle.

Time specification  [ms] (10-32767) ▾  
Samples data at the specified time interval.

Condition specification  
Specifies data sampling timing by device data conditions.

Device	Conditional formula	Radix	Value
<input type="text"/>	<input type="text"/>	<input type="text"/>	<input type="text"/>

Data type(K)

### Displayed items

Item	Description	Setting range	Default
Each scanning cycle	Select this item to collect scan data obtained for each scan operation.	—	—
Time specification	Select this checkbox to collect data at a timing when the first END processing is done after the specified time interval is elapsed.	ms: 10 to 32767 s: 1 to 86400	10 ms
Condition specification	Specify the data collection timing according to the device data conditions.	☞ Page 166 Condition specification	—

## Data

The following window configures the various items such as data format of the target collection device.

### Window

Logging type > Sampling > **Data** > Output > Save > Movement > Finish

Set the data for logging.

A total of up to 128 device points can be set.  
Bit digit specification is using points corresponding to data type. (1 point for word type and 2 points for double-word type)

No.	Device		Data Type	Size [Byte]	Output Format
	Head	Last			
001			▾		...
002			▾		...
003			▾		...
004			▾		...
005			▾		...

## Displayed items

Item	Description	Setting range	Default
No.	In this column, the data setting numbers from 001 to 128 are displayed.	—	—
Device	Head	☞ Page 168 Data to be collected	
	Last		
Data Type	Select the type of target data.	☞ Page 168 Data type	
Size [Byte]	Specify the data size when the data type is set to "String" or "Raw".	1 to 256 bytes	
Output Format	Clicking the [...] button at the rightmost part of each row displays the "Output Format (integer.float)" list. Select the format to be used when data is output to the file.	☞ Page 169 Data output specifications	

## Batch insertion of data

The following window is to insert data items into the data list at once. Data is inserted into blank rows in the list of the "Data" setting window in order from the top (when a setting already exists in the target insertion row, the row is skipped without overwriting it).

### Operating procedure

1. Open the following window.  
 [Edit] ⇒ [Batch Data Insertion]
2. Configure the setting items and continuous settings, and click the [OK] button.

### Window

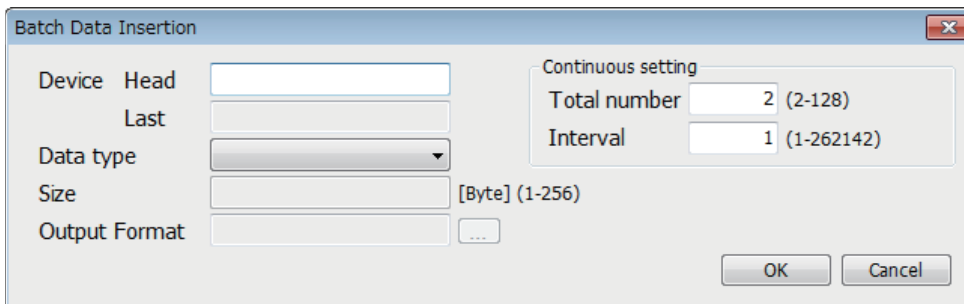

## Displayed items

Item	Description	Setting range	Default
Device	Head	Same as the data setting (☞ Page 928 Data)	Same as the data setting (☞ Page 928 Data)
	Last		
Data type			
Size			
Output Format			
Continuous setting	Total number	Specify the total number of data items to be inserted at once.	2 to 128
	Interval	Specify the device interval of data to be inserted at once.	1 to 262142

## Trigger

The following window specifies the trigger condition when the trigger logging is selected (  Page 168 Trigger condition)

### Window

Logging type > | Sampling > | Data > | **Trigger >** | Number of logging lines > | Output > | Save > | Movement > 

Make trigger setting.

Condition specification  
Sets trigger condition with device data values.

Device  Conditional formula  Radix  Value

Data type(K)

When trigger instruction executed  
Trigger conditions met when LOGTRG instruction is executed.

### Displayed items

Item	Description	Setting range	Default
Condition specification	Configure the trigger condition based on the device data condition.	 Page 169 Condition specification	Checked
When trigger instruction executed	Trigger condition is established when the LOGTRG instruction is executed.	—	—

## Number of records

The following window specifies the number of records to be output before and after trigger occurrences when the trigger logging is selected (  Page 165 Number of records)

### Window

Logging type > | Sampling > | Data > | Trigger > | **Number of logging lines >** | Output > | Save > | Movement > 

Data before and after trigger condition rises will be logged.  
Specify the numbers of records before and after trigger.

No. of records (before trigger)  [Record] (0-99999)

No. of records (after trigger)  [Record] (1-100000)

Total No. of records  [Record] (1-100000)

### Displayed items

Item	Description	Setting range	Default
No. of records (before trigger)	Specify the number of records to be output as pre-trigger record.	0 to 99999	1
No. of records (after trigger)	Specify the number of records to be logged during and after a trigger occurrence.	1 to 100000	1
Total No. of records	View the total number of pre-trigger and post-trigger records.	—	2

## Output

The following window specifies the items to be output into the file. (Page 169 Data output specifications)

### Window

### Displayed items

Item	Description	Setting range	Default
Date	Output date	*2*3	Checked (YYYY/MM/DD hh:mm:ss.sss)
	Set Date Line Format*1		
Trigger information	Output trigger information	256 characters or less	— (* )
	String for Indicating Trigger Occurrence*1		
Index	Output index	—	Checked
Data sampling interval	Output data sampling interval		
Comment	Output comments	256 characters or less (No line feed can be used.)	LOG [Logging setting No.]
	Comment*5		

\*1 Only CSV file is supported for the file format.

\*2 Data output format can be created by combining the following formats.

- Year: YYYY for four-digit expression; YY for two-digit expression
- Month: MM
- Day: DD
- Hour: hh
- Minute: mm
- Second: ss
- Millisecond: ms (three-digit expression), or s, ss, sss, ssss, ssssss, sssssss, or ssssssss (second unit after the decimal point, maximum of seven digits)

Example: YYYY/MM/DD hh:mm:ss.sss → 2016/10/13 09:44:35.241

\*3 When either of "Year", "Month", "Day", "Hour", "Minute", or "Second" is omitted, if opening the data logging file by GX LogViewer, the index expression is used rather than the time expression.

GX LogViewer Version 1 Operating Manual

\*4 If characters other than a single-byte character are used, the scan time can be long when the logging is started.

\*5 You can use any characters as long as Unicode can describe them. Note, however, that you cannot use ["] (double quotation), [,] (comma) or [;] (semi colon).

## Save

The following window configures the target storage for data logging file and switching timing of storage files. (Page 177 Switching to a storage file)

## Window

## Displayed items

Item	Description		Setting range	Default	
Logging file save setting	File save destination		Specify the storage folder for the data logging file.	60 characters or less (double-byte character not allowed)	
	Folder to store file to be saved		Select information to be added to the name of the folder which stores the storage file.	LOG [Logging setting No.]	
	File name	Simple setting	Specify information to be added to the name of the storage file (the name of the storage folder, date, time) by using the [Simply set additional information] button.	—	Checked
		Optional setting	Specify the format of information to be added to the name of the storage file (the name of the storage folder, date, time) by using the [Optionally set additional information] button. The device data value can be added.*3	*1*2	—
	Add date type	Add date/time when the file switching condition is satisfied and when the file is created if the simple setting or optional setting is selected.	—	—	
File switching setting	Number of files to be saved	Number of files to be saved	Specify the maximum number of storage files.	1 to 65535	1
		Operation when exceeds the number of files	Select the operation when the number of files exceeds the maximum number of files to be saved. (Page 179 Action to take when the maximum number of storage files is exceeded)	<ul style="list-style-type: none"> <li>• Overwrite</li> <li>• Stop</li> </ul>	Overwrite
	File switch timing*4		Select the timing at which the file is replaced with new one (Page 177 File switching condition)	<ul style="list-style-type: none"> <li>• Number of records: 1 to 65500</li> <li>• File size: 10 to 16384K bytes</li> <li>• Condition specification</li> </ul>	Number of records (1000)

- \*1 Date and/or time can be added in any format by using the following character strings.
  - Year: YYYY for four-digit expression; YY for two-digit expression
  - Month: MM
  - Day: DD
  - Day of the week: ddd (Sunday: Sun, Monday: Mon, Tuesday: Tue, Wednesday: Wed, Thursday: Thu, Friday: Fri, Saturday: Sat)
  - Hour: hh
  - Minute: mm
  - Second: ss

Example: for June 18, 2014 (Wednesday), 09:30:15, YYYYMMDDdddhhmmss → 20140618Wed093015\_00000001.BIN

Also when using the additional information simply as a character string rather than the above format, any character string can be added by enclosing it with double-quotation marks (" ").

Example: when adding the character string "address" to the file name, "address" → address\_00000001.BIN can be used.
- \*2 Maximum of 64 characters (including underscore (\_), serial number (eight digits), period, and extension) can be used. However, when specifying a character string that contains double quotation marks (" "), the maximum number reduces by the number of the double quotation marks.
- \*3 When the device data is used for the saved file name, it is recommended that the latch device is used because the saved file may be created after the PLC stops.
- \*4 Reducing the setting value results in frequent file switching, so that it is possible that the scan time and/or the device processing time can be extended.

## Logging operation

The following window specifies the data logging operation when the mode transfers to RUN mode (☞ Page 188 Setting the operation at the time of transition to RUN)

### Window

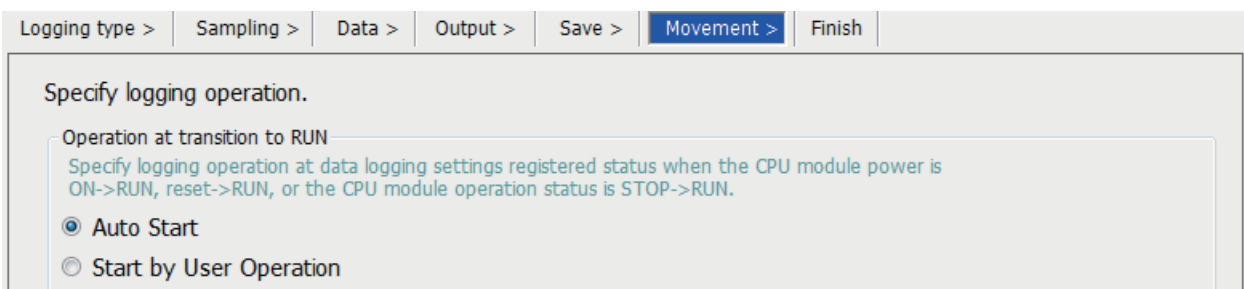

A

### Displayed items

Item	Description	Setting range	Default
Operation at transition to RUN	Select the operation when the mode transfers to RUN mode.	<ul style="list-style-type: none"> <li>• Auto Start</li> <li>• Start by User Operation</li> </ul>	Auto Start

## Finish

The following window is to give the data logging setting a name.

### Window

Logging type > | Sampling > | Data > | Output > | Save > | Movement > | **Finish**

All data required for data logging have been collected.  
Press the "Complete" button to complete setting.

To reflect the settings to the PLC, select [Online]->[Write Logging Setting].

Name the data logging.

Data logging name

Free space volume below in SD memory card will be necessary to execute logging of the set content.  
Larger volume might be necessary depending on status of SD memory card.

Total Size of Output Logging Files  [MB]

To execute logging of the settings, the following internal buffer capacity is required.  
Please set internal buffer capacity as needed.

Required Internal Buffer Capacity in Logging  [KB]

The internal buffer capacity can be set in  
'Parameter->Control CPU->CPU Parameter->Memory/Device Setting->Internal Buffer Volume Setting' of GX Works3.  
Default value: 80[KB]

### Displayed items

Item	Description	Setting range	Default
Data logging name*1	Give the data logging setting being configured a name.	32 characters or less	LOG [Logging setting No.]
Total Size of Output Logging Files	View the total capacity of the data logging file which is output based on the specified settings. The total capacity can be increased/decreased by adding/removing the items to be output to the file.	—	1
Required Internal Buffer Capacity in Logging	View the internal buffer capacity required to execute the data logging based on the specified settings. This value can be specified with the internal buffer capacity setting of engineering tool (Page 206 INTERNAL BUFFER CAPACITY SETTING)	—	1

\*1 When the following user action is detected, character entry will be disabled

- Entered a character which cannot be handled by the OS language character code.
- Entered a character whose language code is different from the one for characters already input in the same data logging setting.



## Data Logging File Transfer Status

The following window is used to check the file transfer status of data logging files.

### Operating procedure

The file transfer status can be checked on the "Data Logging File Transfer Status" window.

 [Online]⇒[Data Logging File Transfer Status]

### Window

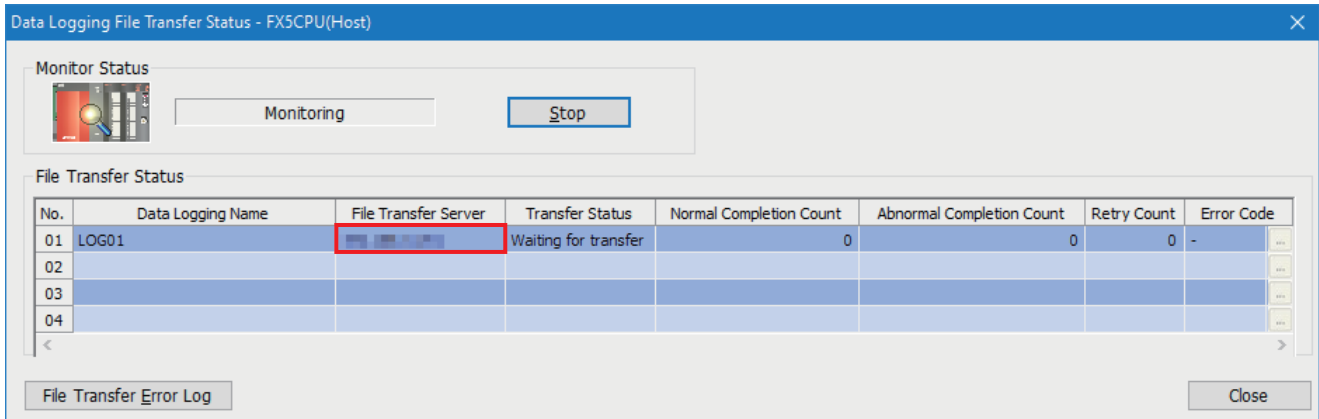

### Displayed items

Item	Description
Data logging setting No.	The data logging setting No. is displayed.
Data Logging Name	The data logging name is displayed.
File Transfer Server	The IP address specified in the server setting is displayed. • Range: 0.0.0.1 to 223.255.255.254
Transfer Status	The transfer status of the data logging file is displayed. • —: The data logging file transfer setting is not set. • Stopped: File transfer is stopped. • Retrying: The file whose transfer failed is being transferred again. • Transferring: Files are being transferred. • Waiting for transfer: Files are waiting to be transferred, or there is no file to be transferred.
Normal Completion Count	The number of data logging files that have been transferred to the FTP server is displayed. • Range: 0 to 4294967295
Abnormal Completion Count	The number of data logging files that have not been transferred to the FTP server is displayed. • Range: 0 to 4294967295
Retry Count	The number of retries is displayed. • Range: 0 to 4294967295
Error Code	The error code of the latest data logging file transfer function error is displayed. • Range: 4000H to 4FFFH, C000H to CFFFH
[...] button	This button is displayed when an error has occurred. Clicking this button displays the error details window.
[File Transfer Error Log] button	Clicking this button displays the error history window. (Page 936 File Transfer Error Log)

A

## File Transfer Error Log

The following window displays the error history of the data logging file transfer function. Up to 20 errors are displayed. When the number of errors exceeds 20, records are deleted in order from the oldest one. The error history is cleared after the power is off and on or the reset operation is performed.

### Window

Status	Date	Data Logging Setting No.	File Name	File Transfer Server	Error Code
✘ Error	9/26/2023 11:03:25	01	-		4C0BH
✘ Error	9/26/2023 11:03:24	01	00000D7.BIN		C616H
✘ Error	9/26/2023 11:02:14	01	-		4C0BH
✘ Error	9/26/2023 11:02:13	01	00000D0.BIN		C616H
✘ Error	9/26/2023 11:01:02	01	-		4C0BH
✘ Error	9/26/2023 11:01:02	01	00000C9.BIN		C616H
✘ Error	9/26/2023 10:59:51	01	-		4C0BH
✘ Error	9/26/2023 10:59:51	01	00000C2.BIN		C616H
✘ Error	9/26/2023 10:58:40	01	-		4C0BH
✘ Error	9/26/2023 10:58:40	01	00000BB.BIN		C616H
✘ Error	9/26/2023 10:57:29	01	-		4C0BH
✘ Error	9/26/2023 10:57:29	01	00000B4.BIN		C616H
✘ Error	9/26/2023 10:56:18	01	-		4C0BH
✘ Error	9/26/2023 10:56:18	01	00000AD.BIN		C616H
✘ Error	9/26/2023 10:55:07	01	-		4C0BH
✘ Error	9/26/2023 10:55:06	01	00000A6.BIN		C616H
✘ Error	9/26/2023 10:53:56	01	-		4C0BH
✘ Error	9/26/2023 10:53:55	01	000009E.BIN		C616H
✘ Error	9/26/2023 10:52:44	01	-		4C0BH
✘ Error	9/26/2023 10:52:44	01	0000097.BIN		C616H

### Displayed items

Item	Description
Status	The file transfer status is displayed. • Error
Date	The date when the data logging file transfer function error occurred is displayed. Format: For the Japanese version, the format is as follows. • "YYYY/MM/DD hh:mm:ss" YYYY: Year (4 digits), MM: Month (2 digits), DD: Day (2 digits), hh: Hour (2 digits), mm: Minutes (2 digits), ss: Seconds (2 digits)
Data Logging Setting No.	The data logging setting No. where the data logging file transfer function error has occurred is displayed. • Range: 1 to 4
File Name	The data logging file name where the data logging file transfer function error has occurred is displayed.*1 • Range: 12 to 64 characters
File Transfer Server	The IP address of the transfer destination server where the data logging file transfer function error has occurred is displayed.*2 • Range: 0.0.0.1 to 223.255.255.254
Error Code	The data logging file transfer function error that has occurred is displayed. • Range: 4000H to 4FFFH, C000H to CFFFH
[...] button	This button is displayed when an error has occurred. Clicking this button displays the error details window.
[Update] button	Clicking this button obtains the error history in the CPU module again and displays it.
[Clear Log] button	Clicking this button clears the error history in the CPU module.

\*1 When the data logging file transfer is stopped or there is no file to be transferred, "—" is displayed.

\*2 Even when the FTP server is specified with the server name in the server setting, the IP address is displayed. However, when the server is not connected, "—" is displayed.

## Supported characters

This section describes the supported characters.

### ■Supported characters for CPU Module Logging Configuration Tool

Any characters that can be expressed by Unicode are supported. However, the supported characters vary for each position as shown in the following table. Note that if attempting to input an unsupported character, the entry is rejected or a message window appears in response to the improper entry.

Place where character is used		Support status of the target character																	
		(SP) <sup>*1</sup>	"	'	*	+	,	/	:	;	<	>	?	[	\	]		.	Two-byte characters
Data Logging Setting	• Data logging name • String for Indicating Trigger Occurrence • Comment	○	×	○	○	○	×	○	○	×	○	○	○	○	○	○	○	○	○
	Date Line Output Format	○	×	○	○	○	×	○	○	×	○	○	○	○	○	○	○	○	×
Logging File Operation	Directory	×	×	○	×	○	×	○	×	×	×	×	○	×	○	×	×	×	

\*1 (SP) means a space.



Surrogate pair characters cannot be used.

### ■Supported characters for file and/or folder (directory) name

Characters in the shaded area can be used.

	0	1	2	3	4	5	6	7	8	9	A	B	C	D	E	F
0	NULL		(SP)	0	@	P	`	p				-	々	ミ		
1			!	1	A	Q	a	q			。	ア	チ	ム		
2			"	2	B	R	b	r			「	イ	ツ	メ		
3			#	3	C	S	c	s			」	ウ	フ	モ		
4			\$	4	D	T	d	t				エ	ト	ヤ		
5			%	5	E	U	e	u			,	オ	ナ	ユ		
6			&	6	F	V	f	v			.	カ	ニ	ヨ		
7			'	7	G	W	g	w			ヲ	キ	ヌ	ウ		
8			(	8	H	X	h	x			ア	ク	ネ	リ		
9			)	9	I	Y	i	y			イ	ケ	ノ	ル		
A			*	:	J	Z	j	z			ウ	コ	ハ	レ		
B			+	;	K	[	k	{			エ	サ	ヒ	口		
C			,	<	L	¥	l				キ	シ	フ	ワ		
D			-	=	M	]	m	}			エ	入	ハ	ソ		
E			.	>	N	^	n	~			ヨ	セ	ホ	ニ		
F			/	?	O	_	o				ツ	リ	マ	。		

## Procedure for installing the built-in USB driver of the FX5S/FX5UJ CPU modules

To communicate with the FX5S/FX5UJ CPU module via USB, a USB driver needs to be installed.

This section describes the installation procedure of a USB driver.

If multiple MELSOFT products are installed, refer to their installed location.

### ■Windows® XP

#### Operating procedure

1. Connect a personal computer to the CPU module with a USB cable, and power on the CPU module.
2. Select "Install from a list or specific location (Advanced)" on the "Found New Hardware Wizard" window.
3. On the next window, select "Search for the best driver in these locations". Check the "Include this location in the search" checkbox, and specify the "Easysocket\USBDrivers" folder where the CPU Module Logging Configuration Tool has been installed.

#### Precautions

If the driver cannot be installed, check the following setting on Windows®.

Select [Control Panel] ⇒ [System] ⇒ [Hardware], and click the [Driver Signing] button. If "Block - Never install unsigned driver software" is selected, the USB driver may not be installed. Select "Ignore - Install the software anyway and don't ask for my approval" or "Warn - Prompt me each time to choose an action", and then install the USB driver.

### ■Windows Vista®

#### Operating procedure

1. Connect a personal computer to the CPU module with a USB cable, and power on the CPU module.
2. Select "Locate and install driver software (recommended)" on the "Found New Hardware" window.
3. On the next window, select "Browse my computer for driver software (advanced)".
4. On the next window, select "Search for the best driver in these locations". Check the "Include subfolders" checkbox, and specify the "Easysocket\USBDrivers" folder where the CPU Module Logging Configuration Tool has been installed.

#### Precautions

If "Windows can't verify the publisher of this driver software" appears on the "Windows Security" window, select "Install this driver software anyway".

### ■Windows® 7 and later

#### Operating procedure

1. Connect a personal computer to the CPU module with a USB cable, and power on the CPU module.
2. Select [Start] ⇒ [Control Panel] ⇒ [System and Security] ⇒ [Administrative Tools] ⇒ [Computer Management] ⇒ [Device Manager]. Right-click "Unknown device", and click "Update Driver Software".
3. On the "Update Driver Software" window, select "Browse my computer for driver software" and specify the "Easysocket\USBDrivers" folder where the CPU Module Logging Configuration Tool has been installed on the next window.

# Appendix 9 Connection Example of Servo Amplifier

---

Examples (sink input/sink output) of connecting a CPU module and high-speed pulse input/output module to a MELSERVO MR-J5□A, MR-J4□A, MR-J3□A or MR-JN□A series servo amplifier are shown.

For pulse output mode, refer to  Page 370 Pulse Output Mode.

For DABS instruction, refer to  Page 483 Absolute Position Detection System.

For input/output of the CPU module and high-speed pulse input/output module assigned, refer to the following.

 Page 341 Input assignment

 Page 346 Assignment of output numbers

For details of the I/O module, refer to the following manuals.

 MELSEC iQ-F FX5S/FX5UJ/FX5U/FX5UC User's Manual (Hardware)

For details of the servo amplifier, refer to the manual for each servo amplifier.

# MELSERVO-J5, MELSERVO-J4, MELSERVO-J3 series

## FX5S CPU module

### ■PULSE/SIGN mode

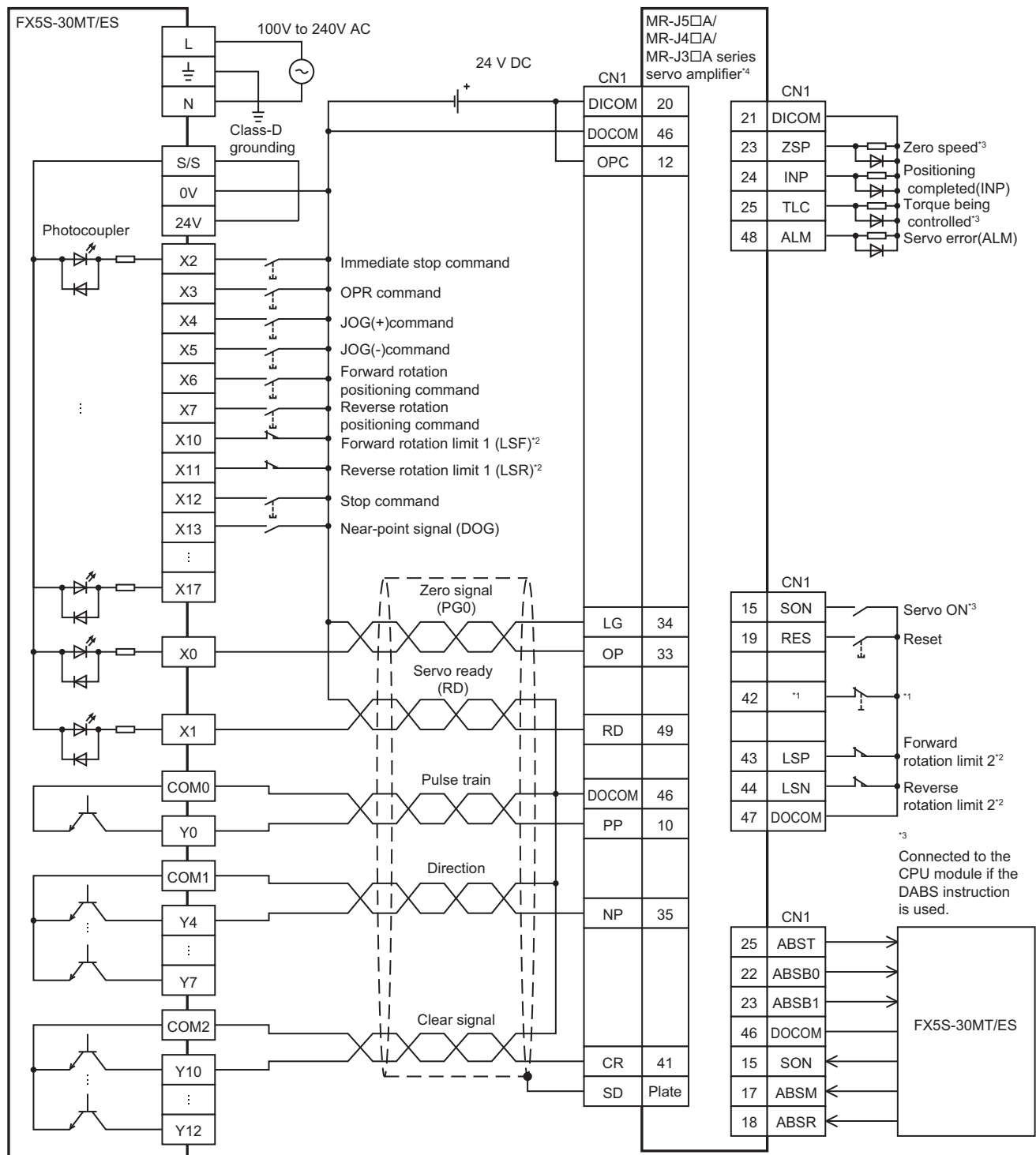

- \*1 EM2 (forced stop 2) for MR-J5□A type/MR-J4□A type servo amplifier, and EMG (emergency stop) for MR-J3□A type servo amplifier
- \*2 For details, refer to Page 942 Precautions.
- \*3 To detect absolute positions, connect this line to the CPU module. For details, refer to Page 942 Precautions.
- \*4 Set the command pulse input form PA13 as below.
  - MR-J5□A type/MR-J4□A type servo amplifier: "0211" (negative logic, signed pulse train, command input pulse train filter 500kpps or less)
  - MR-J3□A type servo amplifier: "0011" (negative logic, signed pulse train)

## ■CW/CCW mode

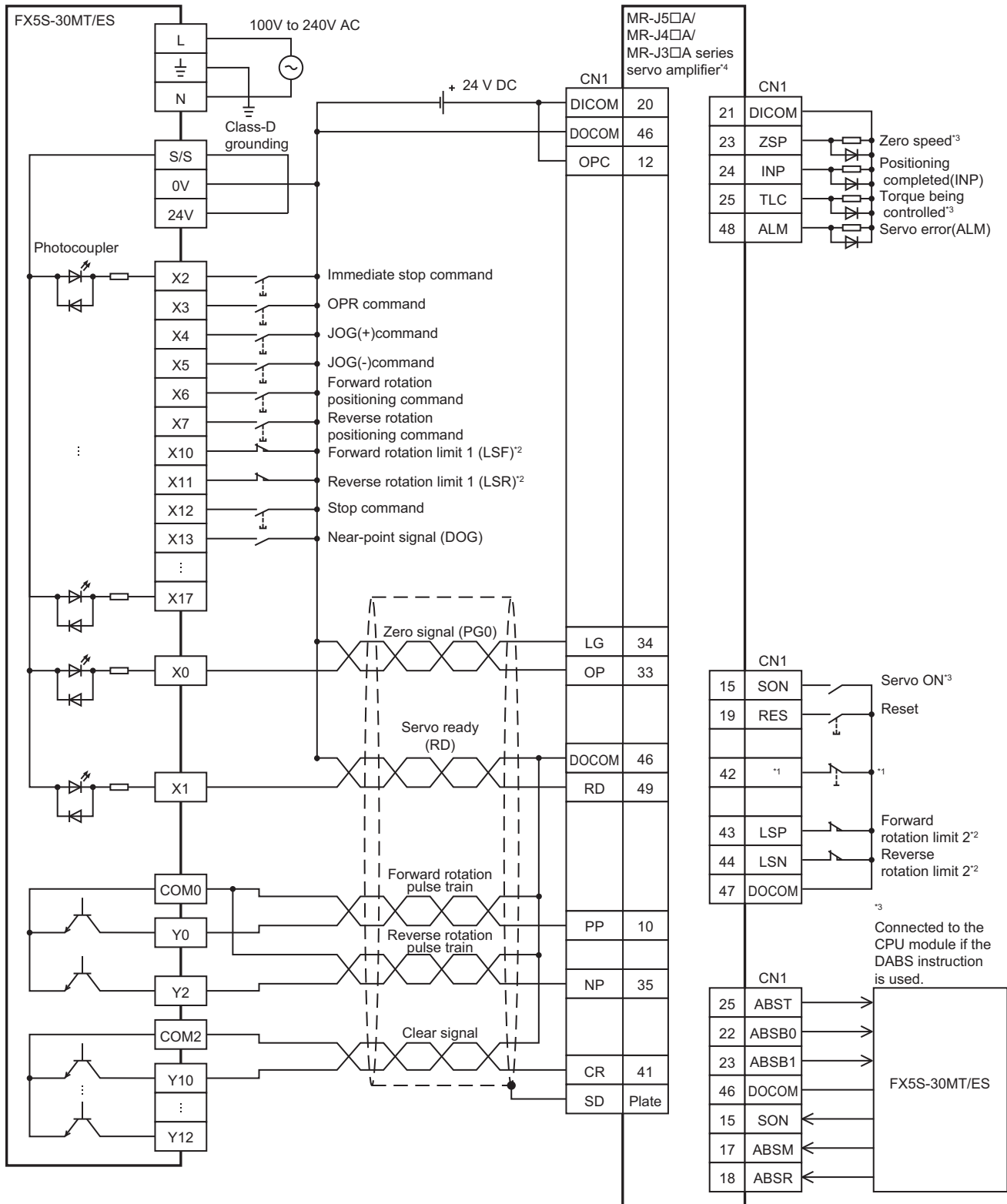

\*1 EM2 (forced stop 2) for MR-J5□A type/MR-J4□A type servo amplifier, and EMG (emergency stop) for MR-J3□A type servo amplifier

\*2 For details, refer to Page 942 Precautions.

\*3 To detect absolute positions, connect this line to the CPU module.

For details, refer to Page 942 Precautions.

\*4 Set the command pulse input form PA13 as below.

· MR-J5□A type/MR-J4□A type servo amplifier: "0210" (negative logic, forward pulse train, reverse pulse train, command input pulse train filter 500kpps or less)

· MR-J3□A type servo amplifier: "0010" (negative logic, forward pulse train, reverse pulse train)



## ■Precautions

- Use a CPU module and I/O module with transistor output.
- Be sure to use the class-D grounding method (grounding resistance: 100 Ω or less).
- To ensure safety, use the forward rotation limit switch and the reverse rotation limit switch on both sides: the CPU module side and the servo amplifier side.

Note that the limit switches on the CPU module side should be activated slightly earlier than the limit switches on the servo amplifier side.

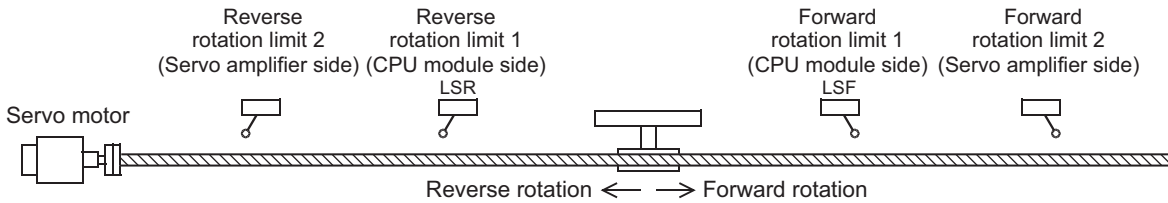

- An example of connection with the CPU module during absolute position detection is shown below.

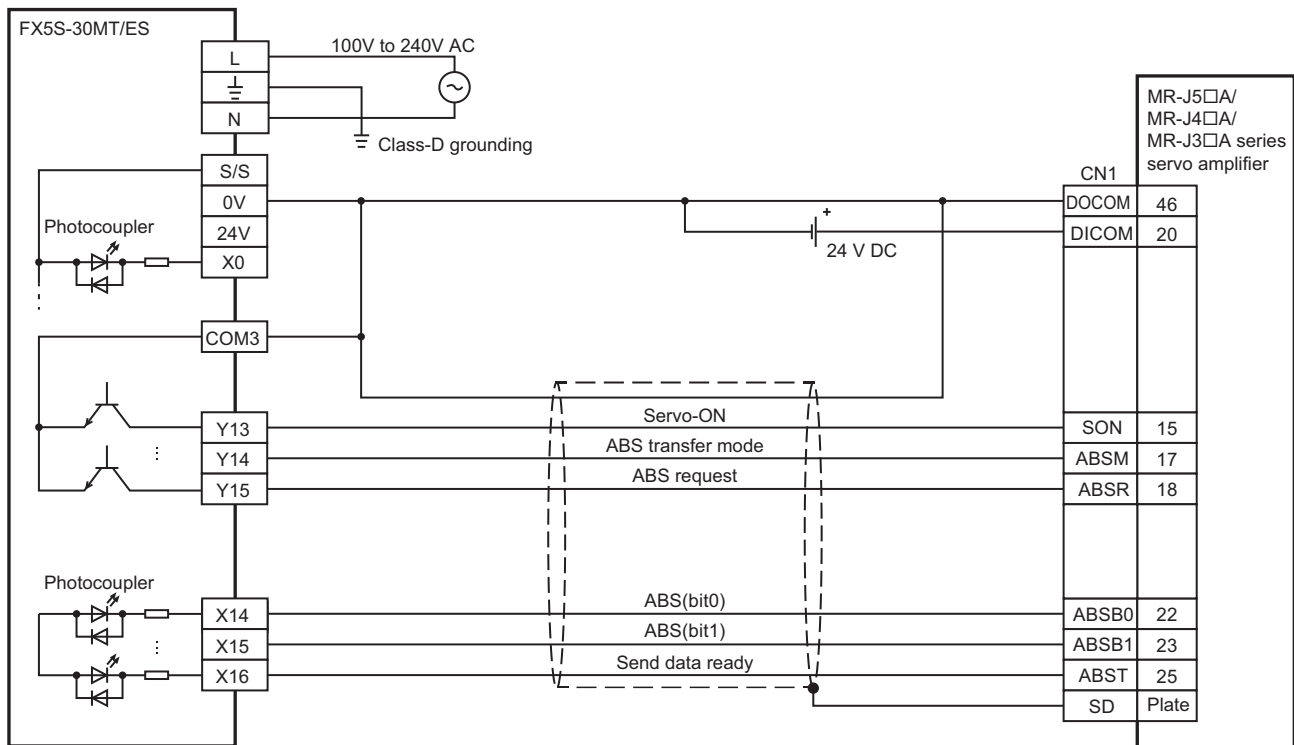



# FX5UJ CPU module

## ■PULSE/SIGN mode

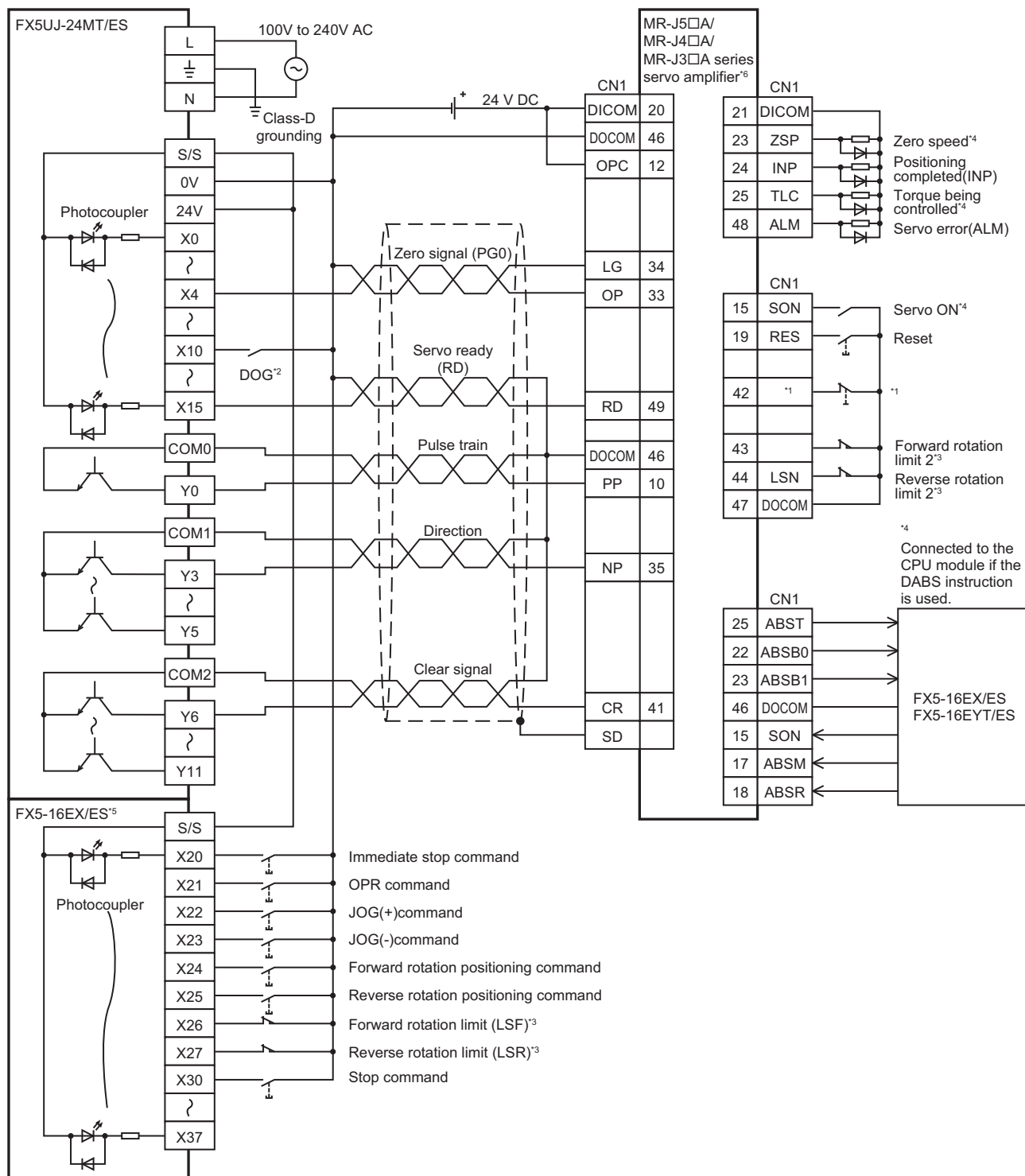

- \*1 EM2 (forced stop 2) for MR-J5□A type/MR-J4□A type servo amplifier, and EMG (emergency stop) for MR-J3□A type servo amplifier
- \*2 Near-point signal (DOG)
- \*3 For details, refer to Page 944 Precautions.
- \*4 To detect absolute positions, connect this line to the CPU module. For details, refer to Page 944 Precautions.
- \*5 I/O module are used in the connection example. Inputs and outputs built into the CPU module are available in place of I/O module.
- \*6 Set the command pulse input form PA13 as below.
  - MR-J5□A type/MR-J4□A type servo amplifier: "0211" (negative logic, signed pulse train, command input pulse train filter 500kpps or less)
  - MR-J3□A type servo amplifier: "0011" (negative logic, signed pulse train)

## ■Precautions

- Use a CPU module and I/O module with transistor output.
- Be sure to use the class-D grounding method (grounding resistance: 100 Ω or less).
- To ensure safety, use the forward rotation limit switch and the reverse rotation limit switch on both sides: the CPU module side and the servo amplifier side.

Note that the limit switches on the CPU module side should be activated slightly earlier than the limit switches on the servo amplifier side.

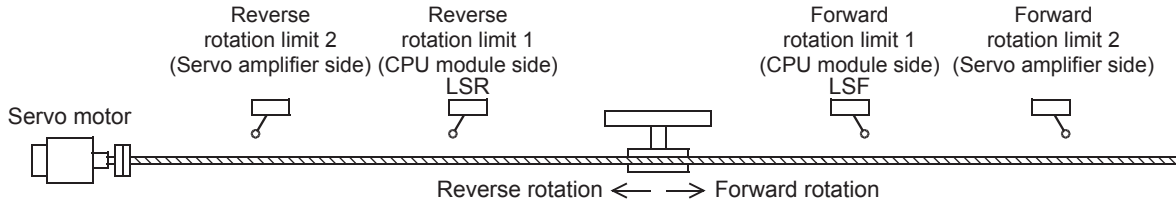

- An example of connection with the CPU module during absolute position detection is shown below.

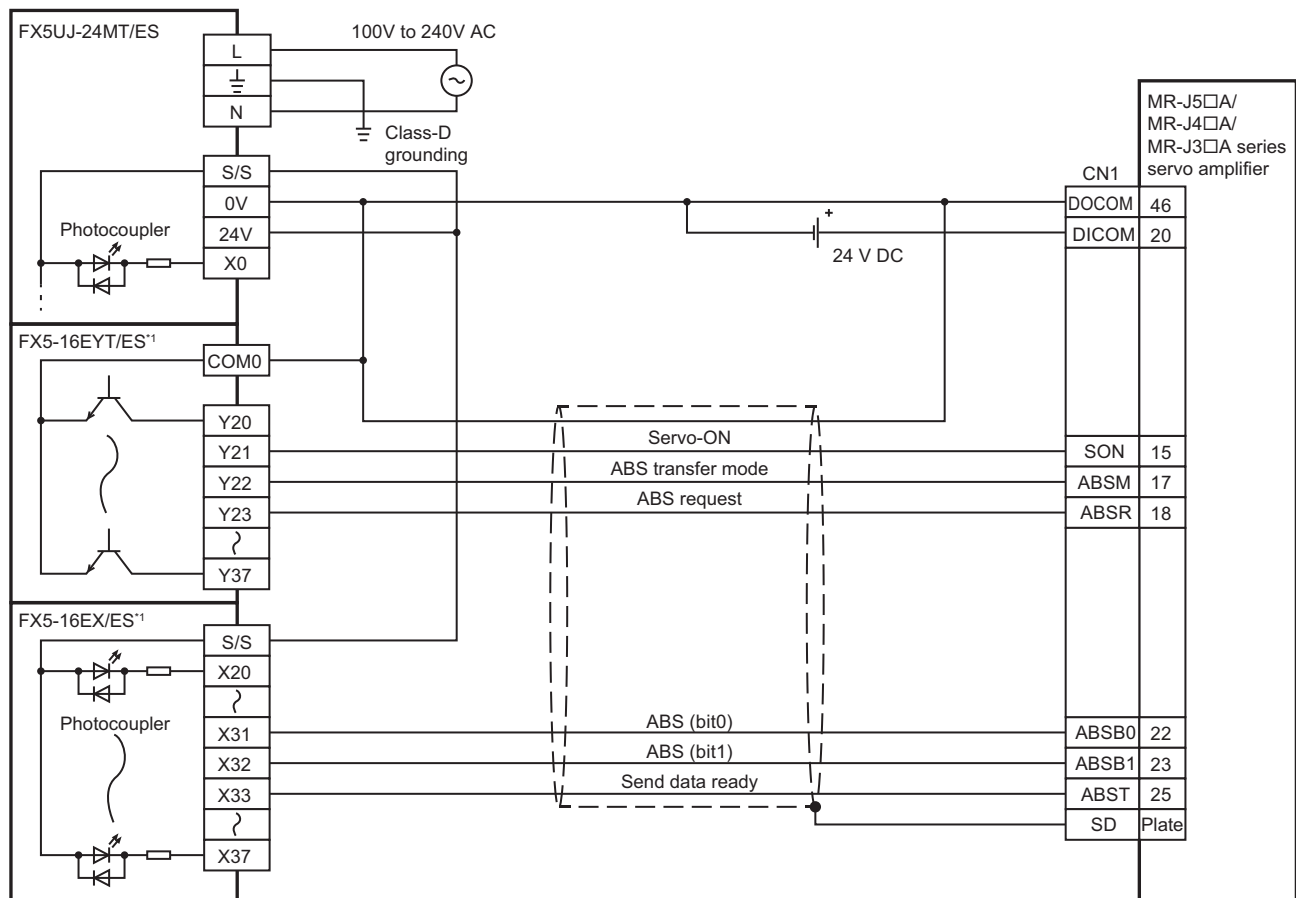

\*1 I/O module are used in the connection example. Inputs and outputs built into the CPU module are available in place of I/O module.

# FX5U CPU module

## ■PULSE/SIGN mode

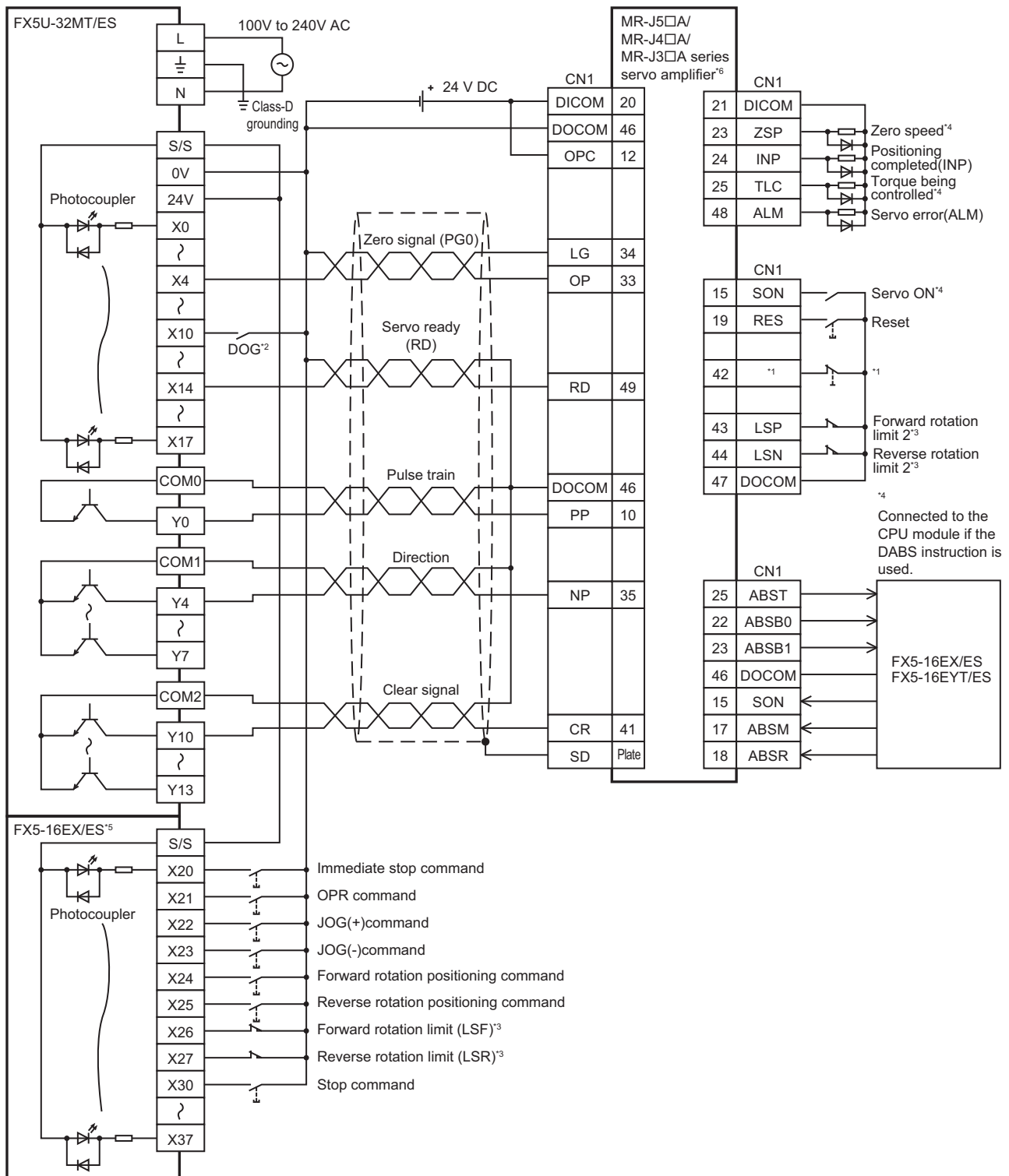

- \*1 EM2 (forced stop 2) for MR-J5□A type/MR-J4□A type servo amplifier, and EMG (emergency stop) for MR-J3□A type servo amplifier
- \*2 Near-point signal (DOG)
- \*3 For details, refer to Page 947 Precautions.
- \*4 To detect absolute positions, connect this line to the CPU module.  
For details, refer to Page 947 Precautions.
- \*5 I/O module are used in the connection example. Inputs and outputs built into the CPU module are available in place of I/O module.
- \*6 Set the command pulse input form PA13 as below.
  - MR-J5□A type/MR-J4□A type servo amplifier: "0211" (negative logic, signed pulse train, command input pulse train filter 500kpps or less)
  - MR-J3□A type servo amplifier: "0011" (negative logic, signed pulse train)



## ■CW/CCW mode

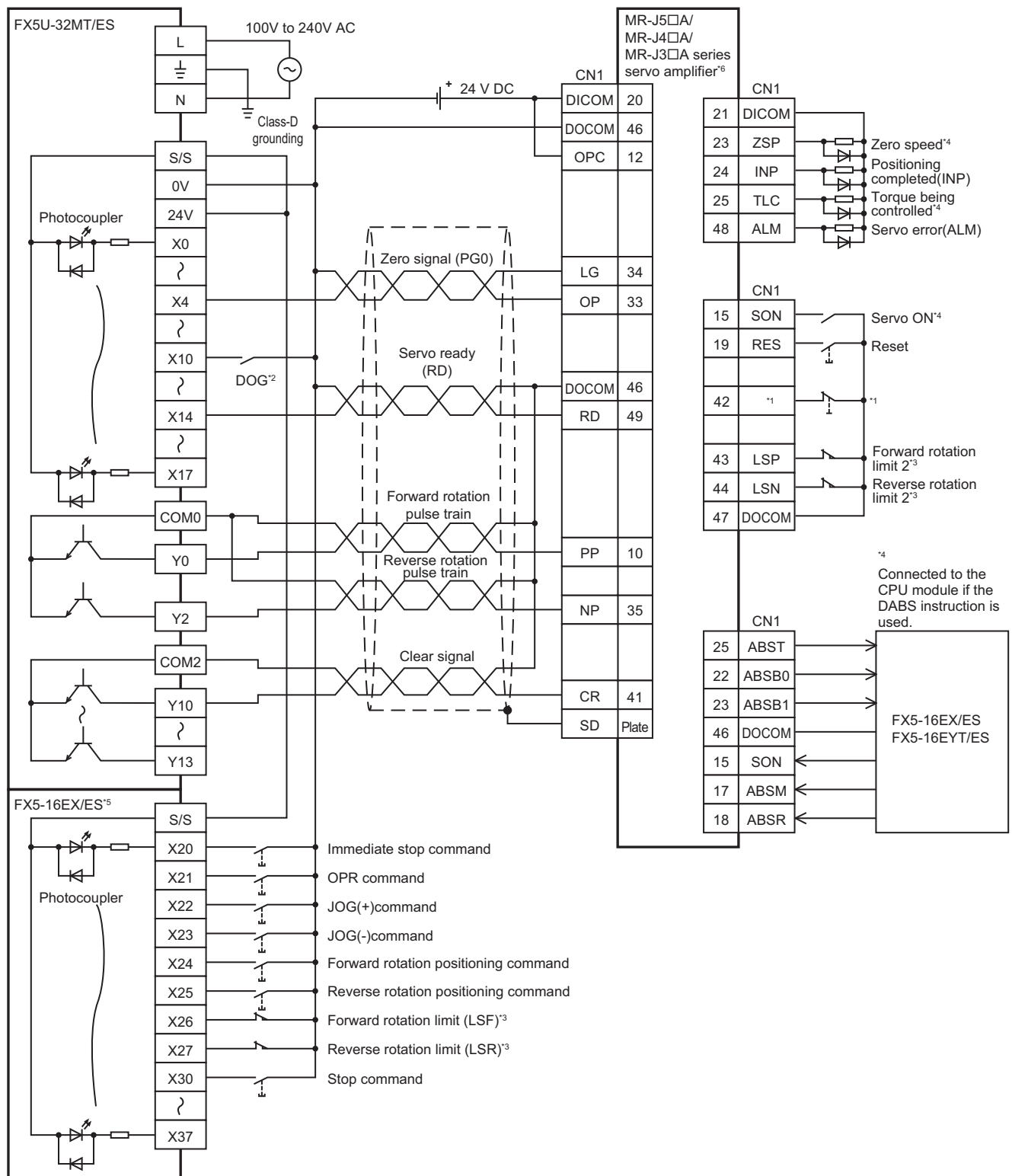

\*1 EM2 (forced stop 2) for MR-J5□A type/MR-J4□A type servo amplifier, and EMG (emergency stop) for MR-J3□A type servo amplifier

\*2 Near-point signal (DOG)

\*3 For details, refer to Page 947 Precautions.

\*4 To detect absolute positions, connect this line to the CPU module.

For details, refer to Page 947 Precautions.

\*5 I/O module are used in the connection example. Inputs and outputs built into the CPU module are available in place of I/O module.

\*6 Set the command pulse input form PA13 as below.

· MR-J5□A type/MR-J4□A type servo amplifier: "0210" (negative logic, forward pulse train, reverse pulse train, command input pulse train filter 500kpps or less)

· MR-J3□A type servo amplifier: "0010" (negative logic, forward pulse train, reverse pulse train)

## ■Precautions

- Use a CPU module and I/O module with transistor output.
- Be sure to use the class-D grounding method (grounding resistance: 100 Ω or less).
- To ensure safety, use the forward rotation limit switch and the reverse rotation limit switch on both sides: the CPU module side and the servo amplifier side.

Note that the limit switches on the CPU module side should be activated slightly earlier than the limit switches on the servo amplifier side.

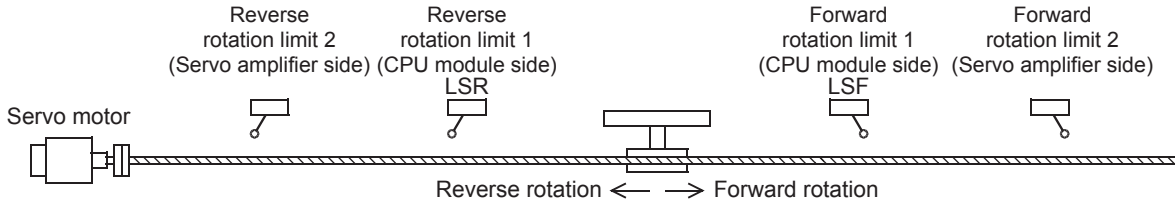

- An example of connection with the CPU module during absolute position detection is shown below.

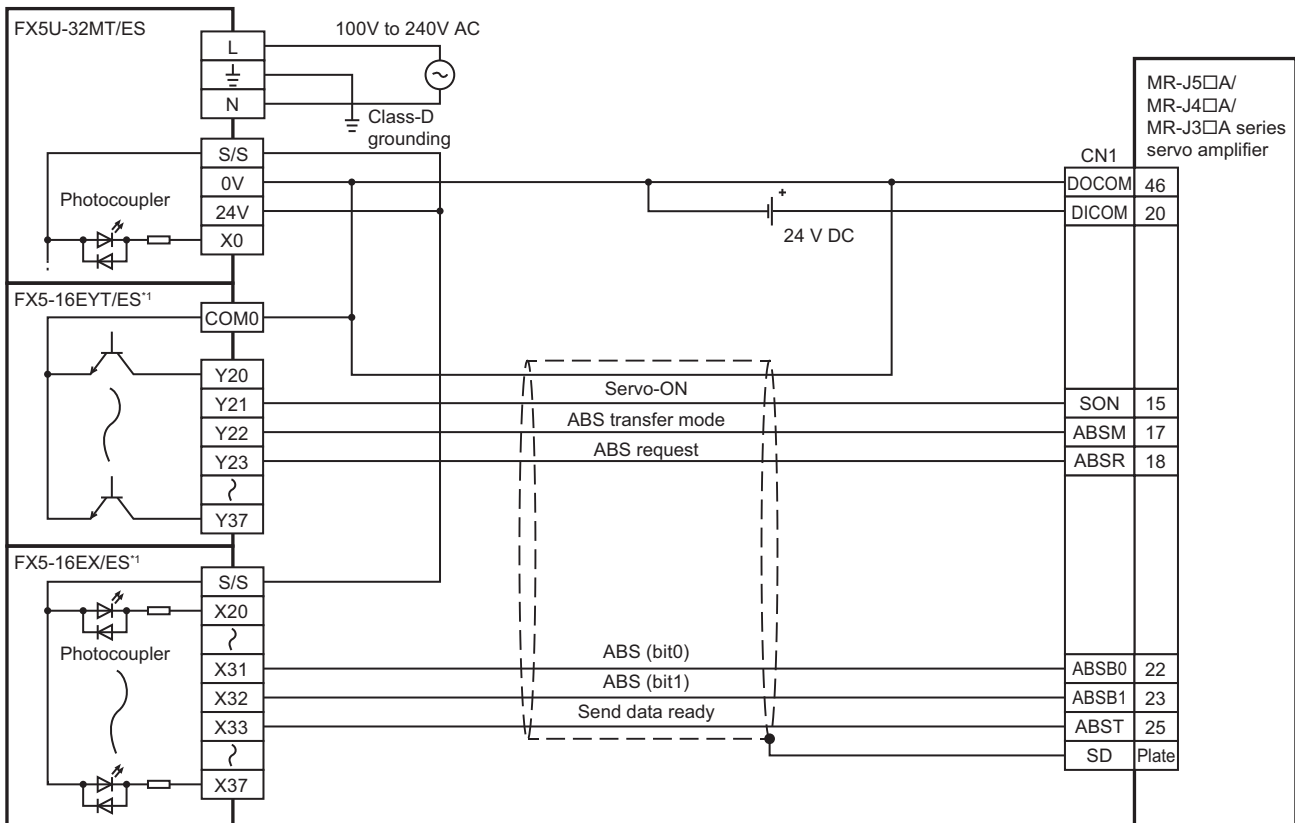

\*1 I/O module are used in the connection example. Inputs and outputs built into the CPU module are available in place of I/O module.



# FX5UC CPU module

## PULSE/SIGN mode

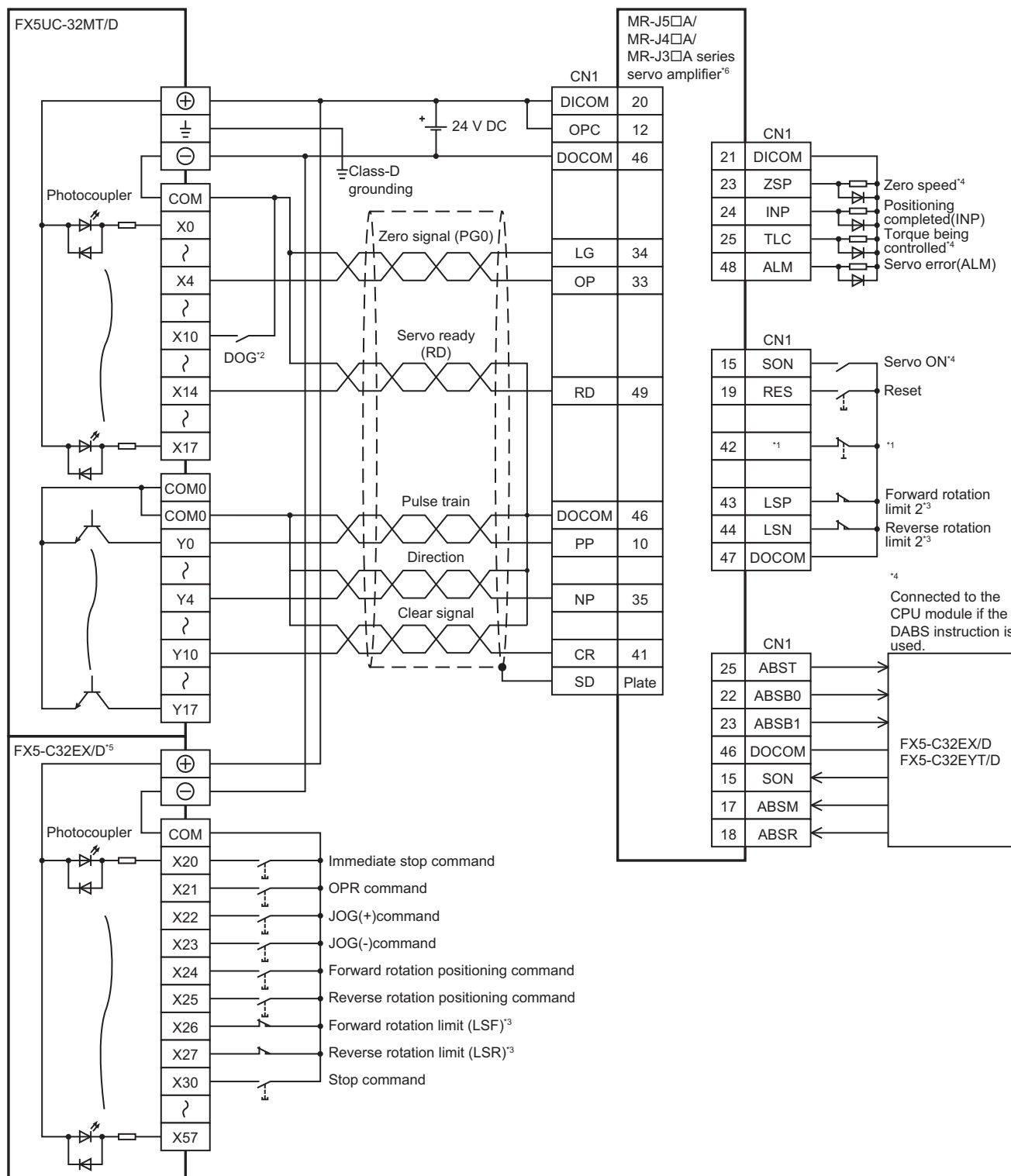

\*1 EM2 (forced stop 2) for MR-J5□A type/MR-J4□A type servo amplifier, and EMG (emergency stop) for MR-J3□A type servo amplifier

\*2 Near-point signal (DOG)

\*3 For details, refer to Page 950 Precautions.

\*4 To detect absolute positions, connect this line to the CPU module.

For details, refer to Page 950 Precautions.

\*5 I/O module are used in the connection example. Inputs and outputs built into the CPU module are available in place of I/O module.

\*6 Set the command pulse input form PA13 as below.

· MR-J5□A type/MR-J4□A type servo amplifier: "0211" (negative logic, signed pulse train, command input pulse train filter 500kpps or less)

· MR-J3□A type servo amplifier: "0011" (negative logic, signed pulse train)

## ■CW/CCW mode

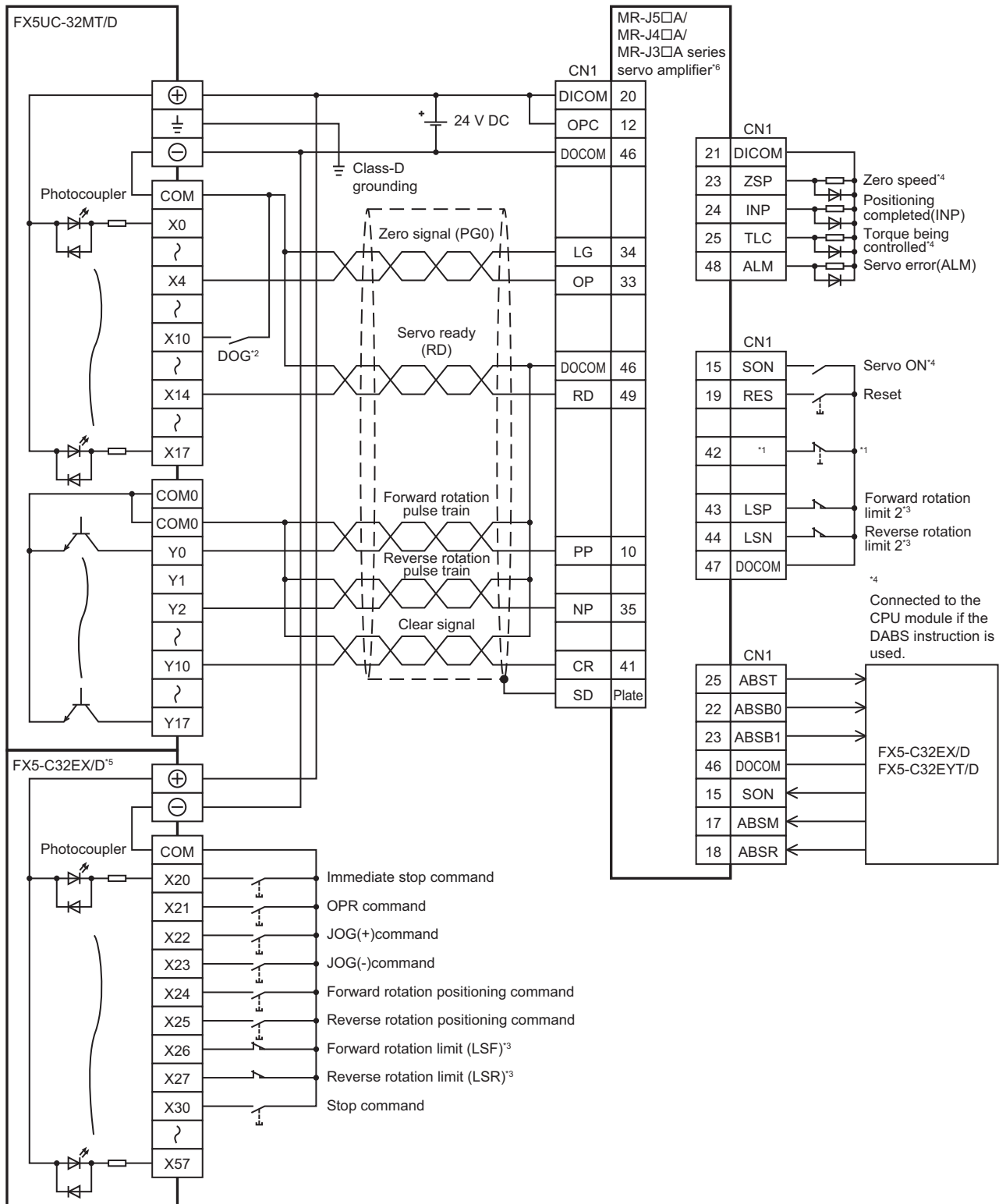

- \*1 EM2 (forced stop 2) for MR-J5□A type/MR-J4□A type servo amplifier, and EMG (emergency stop) for MR-J3□A type servo amplifier
- \*2 Near-point signal (DOG)
- \*3 For details, refer to Page 950 Precautions.
- \*4 To detect absolute positions, connect this line to the CPU module. For details, refer to Page 950 Precautions.
- \*5 I/O module are used in the connection example. Inputs and outputs built into the CPU module are available in place of I/O module.
- \*6 Set the command pulse input form PA13 as below.
- MR-J5□A type/MR-J4□A type servo amplifier: "0210" (negative logic, forward pulse train, reverse pulse train, command input pulse train filter 500kpps or less)
  - MR-J3□A type servo amplifier: "0010" (negative logic, forward pulse train, reverse pulse train)

## ■Precautions

- Use a CPU module and I/O module with transistor output.
- Be sure to use the class-D grounding method (grounding resistance: 100 Ω or less).
- To ensure safety, use the forward rotation limit switch and the reverse rotation limit switch on both sides: the CPU module side and the servo amplifier side.

Note that the limit switches on the CPU module side should be activated slightly earlier than the limit switches on the servo amplifier side.

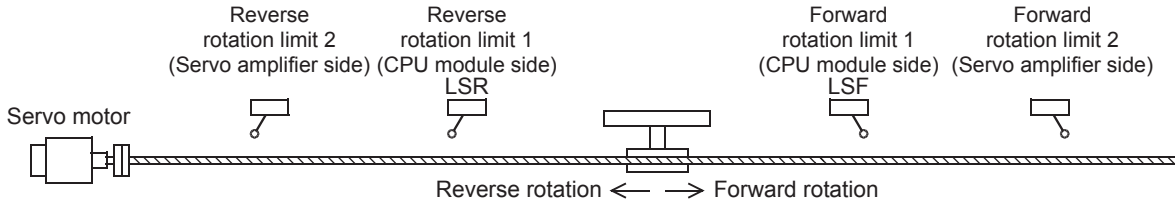

- An example of connection with the CPU module during absolute position detection is shown below.

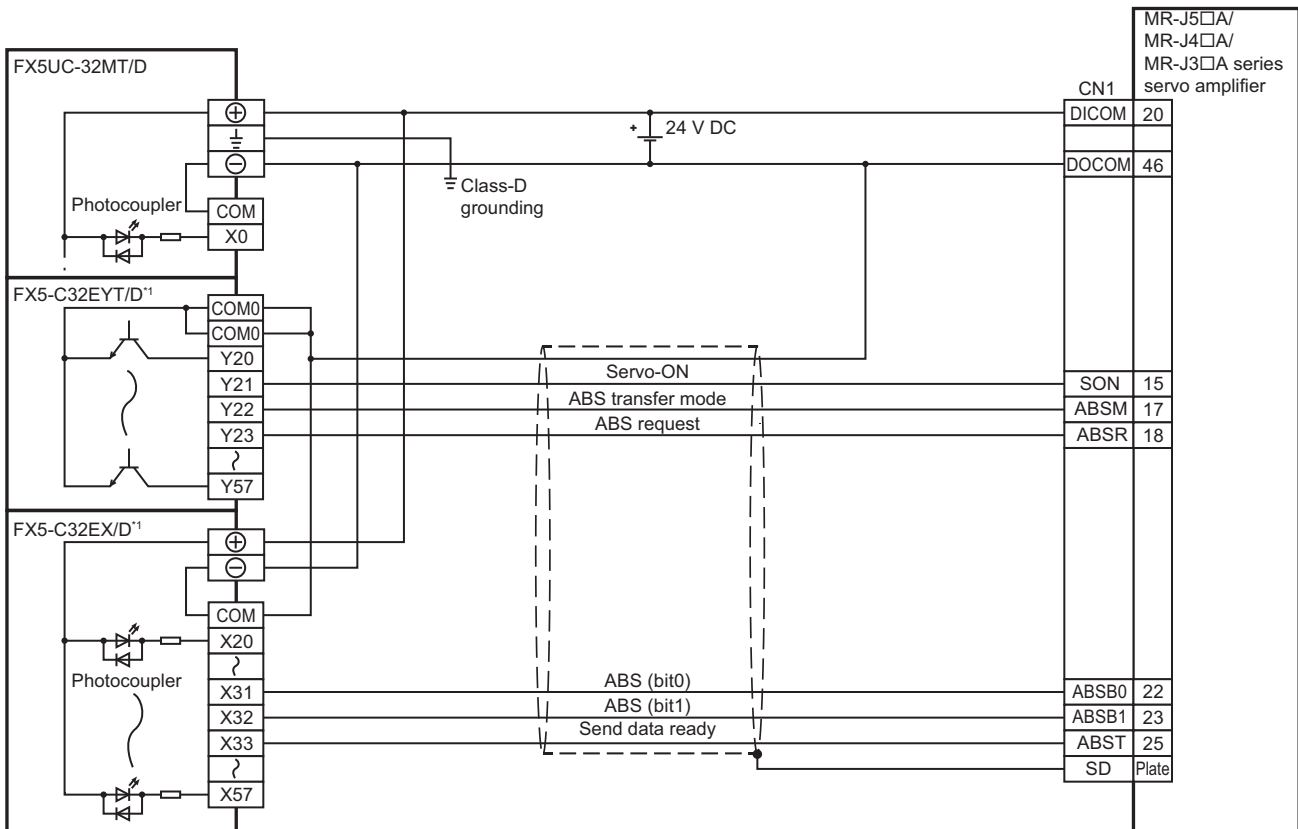

\*1 I/O module are used in the connection example. Inputs and outputs built into the CPU module are available in place of I/O module.



# High-speed pulse input/output module

## ■PULSE/SIGN mode

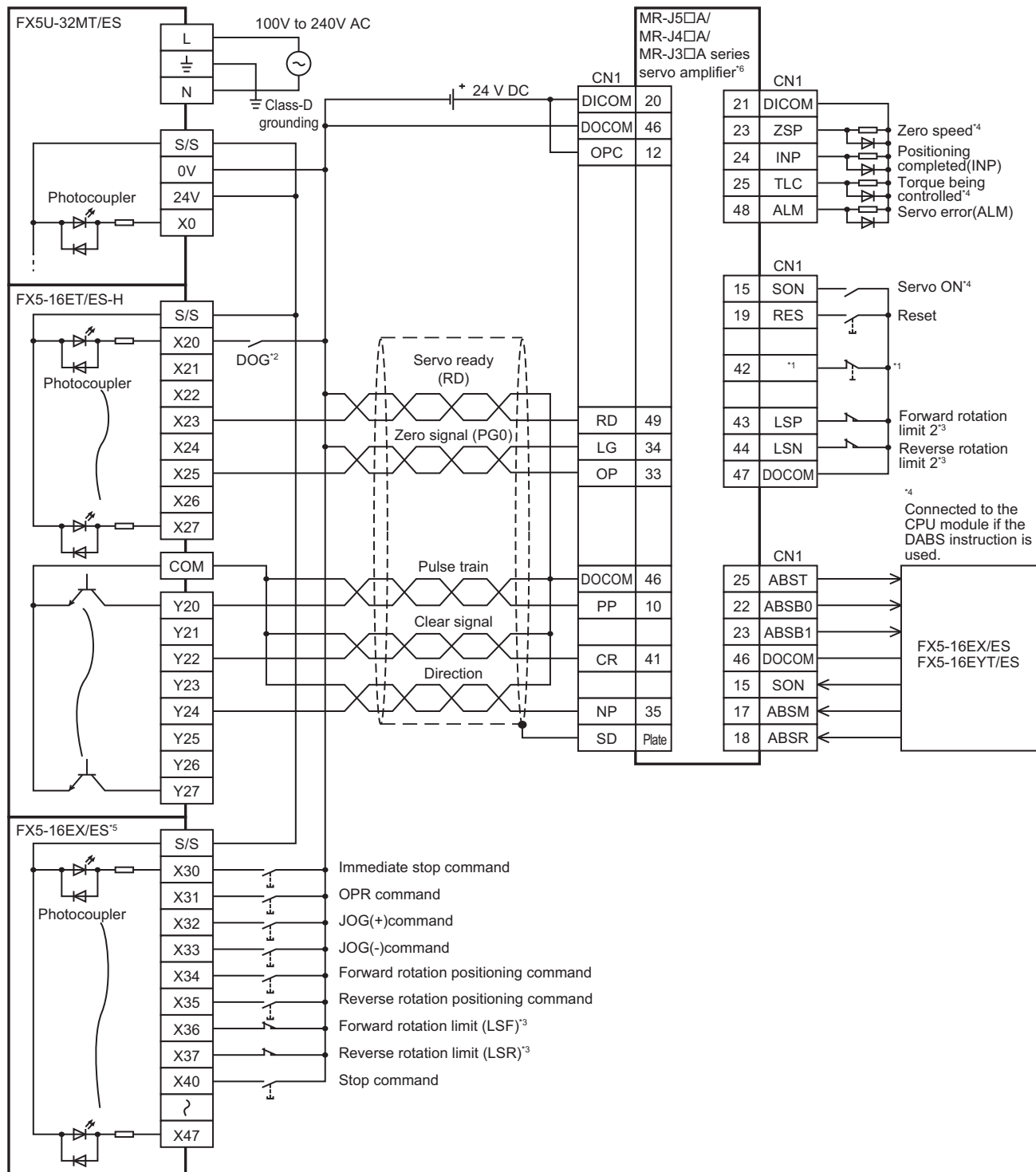

- \*1 EM2 (forced stop 2) for MR-J5□A type/MR-J4□A type servo amplifier, and EMG (emergency stop) for MR-J3□A type servo amplifier
- \*2 Near-point signal (DOG)  
Any input other than high-speed pulse input/output module can also be used.
- \*3 For details, refer to Page 953 Precautions.
- \*4 To detect absolute positions, connect this line to the CPU module.  
For details, refer to Page 953 Precautions.
- \*5 I/O module are used in the connection example. Inputs built into the CPU module are available in place of I/O module.
- \*6 Set the command pulse input form PA13 as below.
  - MR-J5□A type/MR-J4□A type servo amplifier: "0211" (negative logic, signed pulse train, command input pulse train filter 500kpps or less)
  - MR-J3□A type servo amplifier: "0011" (negative logic, signed pulse train)

## ■CW/CCW mode

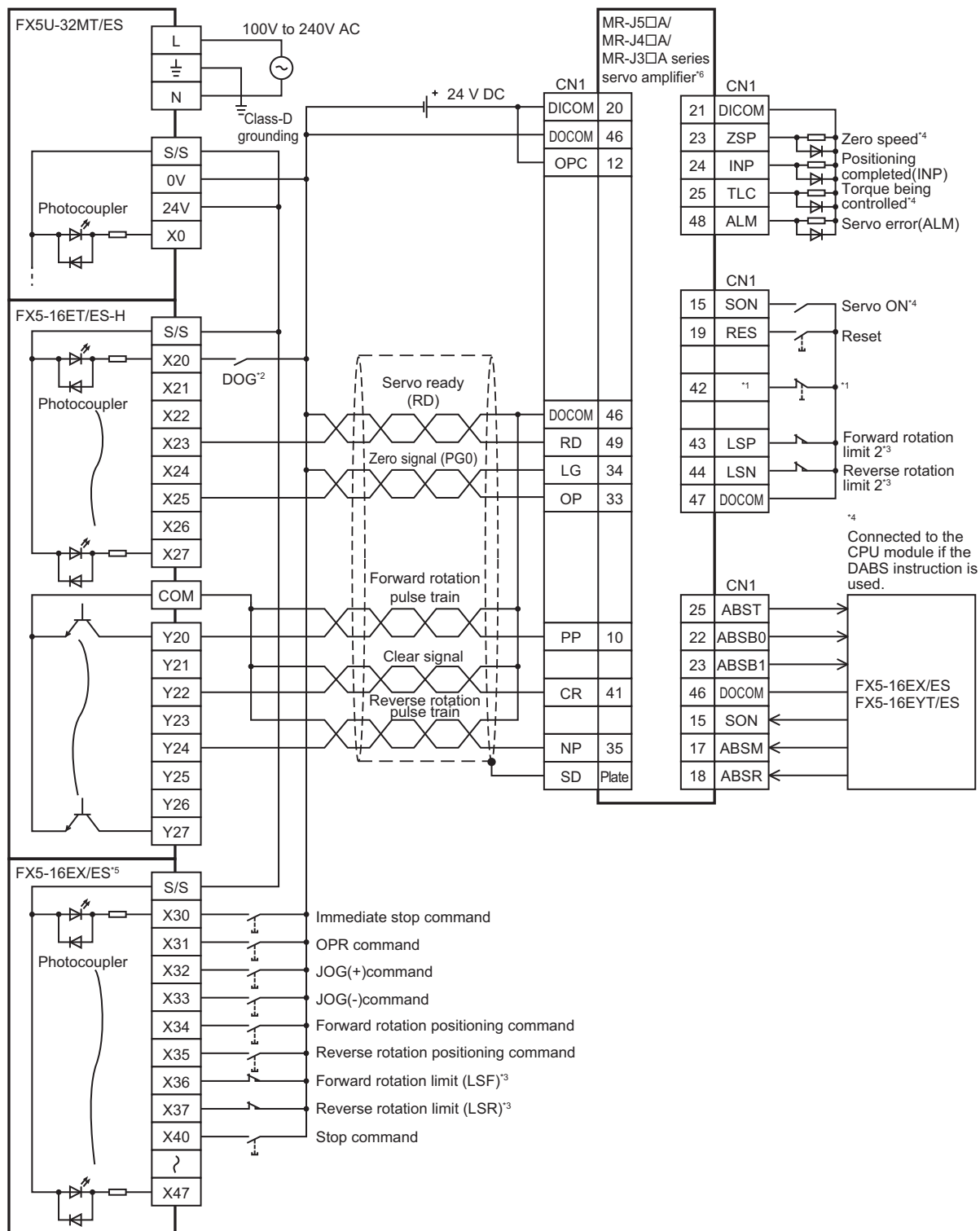

\*1 EM2 (forced stop 2) for MR-J5□A type/MR-J4□A type servo amplifier, and EMG (emergency stop) for MR-J3□A type servo amplifier

\*2 Near-point signal (DOG)  
Any input other than high-speed pulse input/output module can also be used.

\*3 For details, refer to Page 953 Precautions.

\*4 To detect absolute positions, connect this line to the CPU module.  
For details, refer to Page 953 Precautions.

\*5 I/O module are used in the connection example. Inputs built into the CPU module are available in place of I/O module.

\*6 Set the command pulse input form PA13 as below.

· MR-J5□A type/MR-J4□A type servo amplifier: "0210" (negative logic, forward pulse train, reverse pulse train, command input pulse train filter 500kpps or less)

· MR-J3□A type servo amplifier: "0010" (negative logic, forward pulse train, reverse pulse train)

## ■Precautions

- Use a CPU module and I/O module with transistor output.
- Be sure to use the class-D grounding method (grounding resistance: 100  $\Omega$  or less).
- To ensure safety, use the forward rotation limit switch and the reverse rotation limit switch on both sides: the CPU module side and the servo amplifier side.

Note that the limit switches on the CPU module side should be activated slightly earlier than the limit switches on the servo amplifier side.

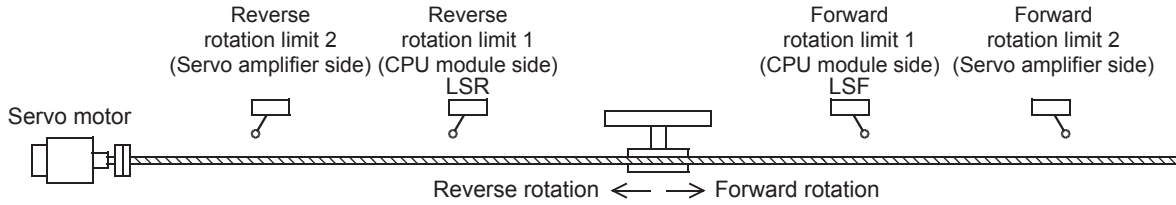

# MELSERVO-JN series

## FX5S CPU module

### ■PULSE/SIGN mode

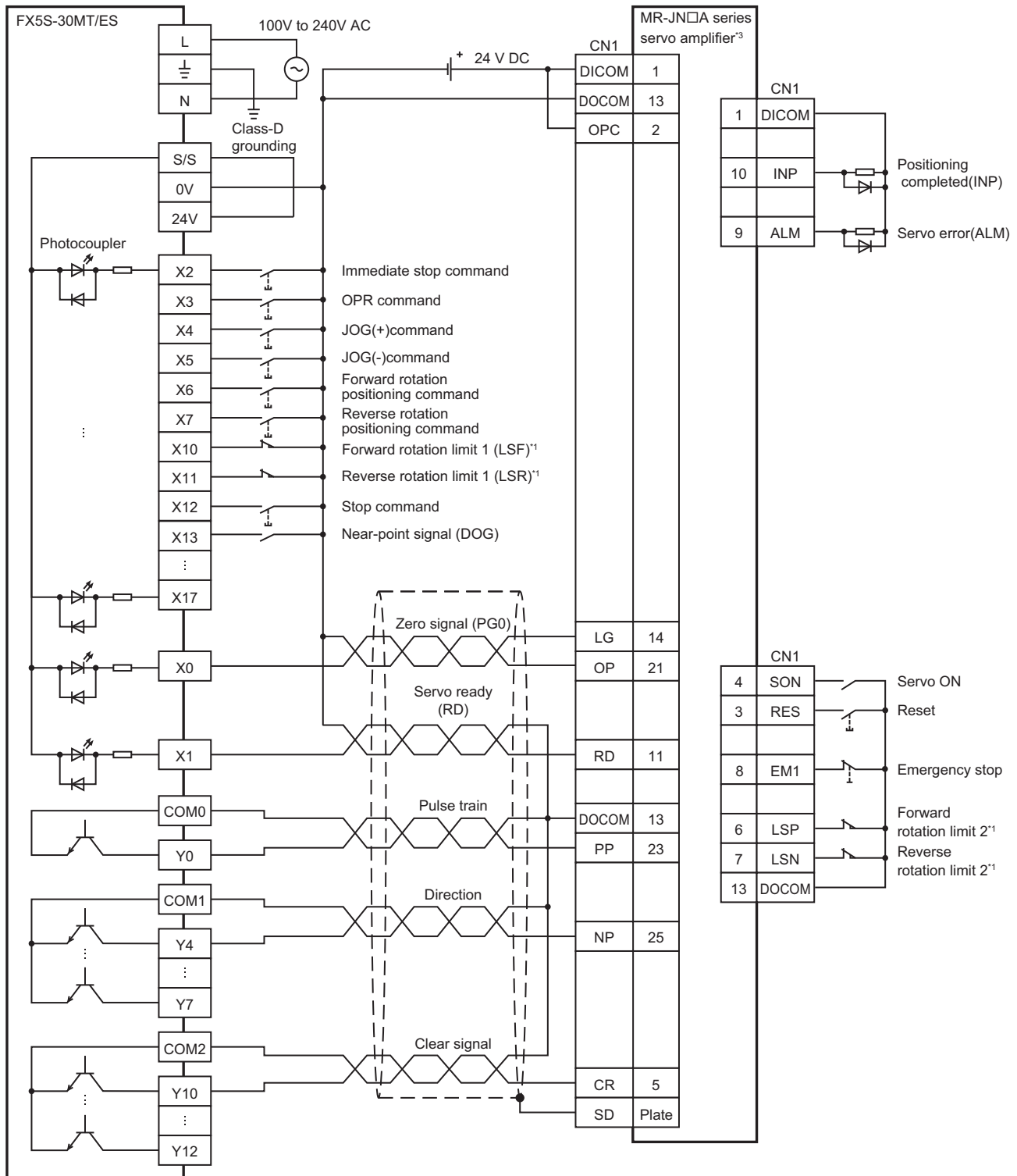

\*1 For details, refer to Page 963 Precautions.

\*2 I/O module are used in the connection example. Inputs and outputs built into the CPU module are available in place of I/O module.

\*3 Set the command pulse input form (PA13) of the MR-JN□A type servo amplifier to "211" (negative logic, signed pulse train, command input pulse train filter: 100kpps or less).

## ■CW/CCW mode

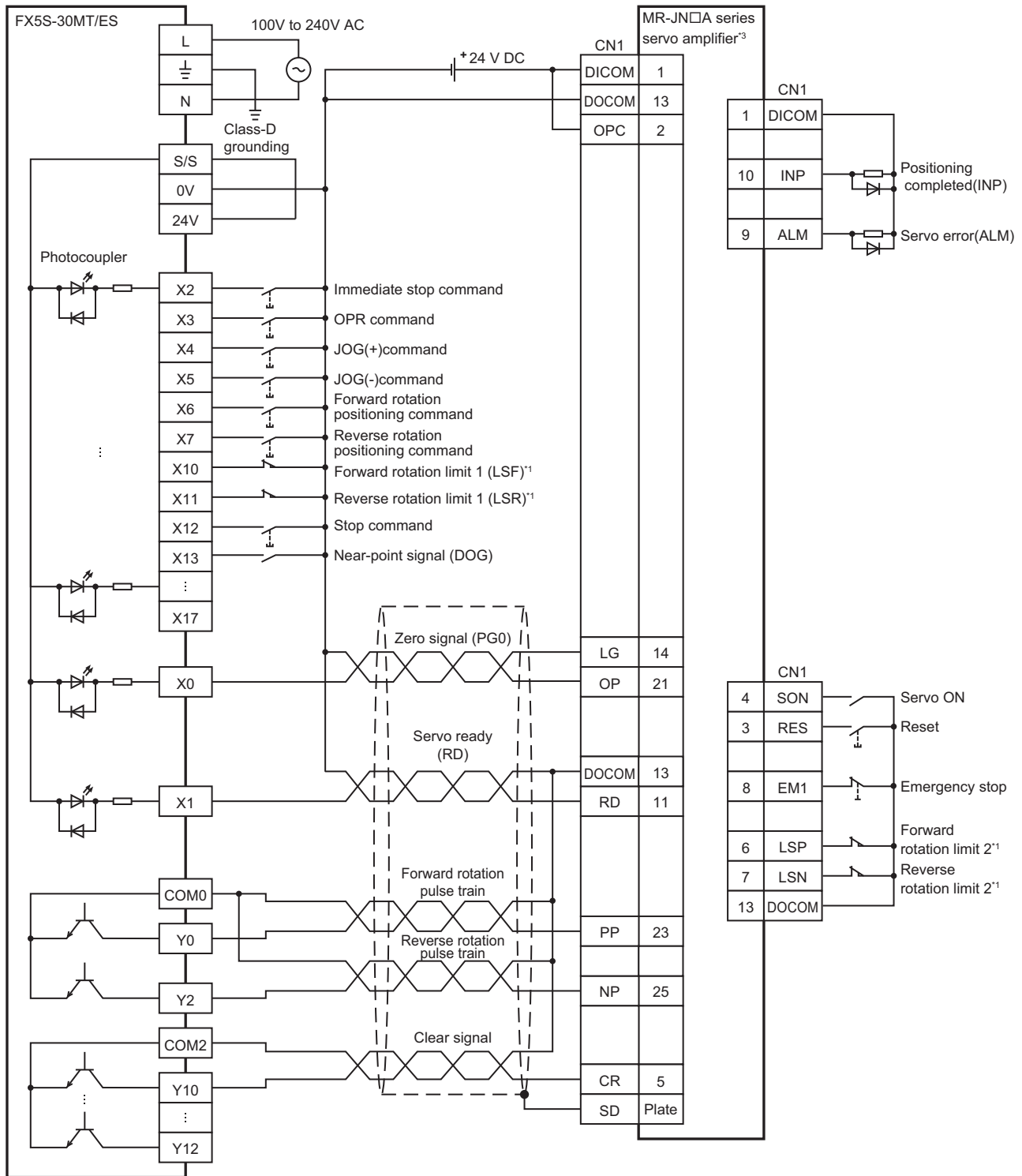

\*1 For details, refer to Page 963 Precautions.

\*2 I/O module are used in the connection example. Inputs and outputs built into the CPU module are available in place of I/O module.

\*3 Set the command pulse input form (PA13) of the MR-JN□A type servo amplifier to "211" (negative logic, forward rotation pulse train, reverse rotation pulse train, command input pulse train filter: 100kpps or less).



# FX5UJ CPU module

## ■PULSE/SIGN mode

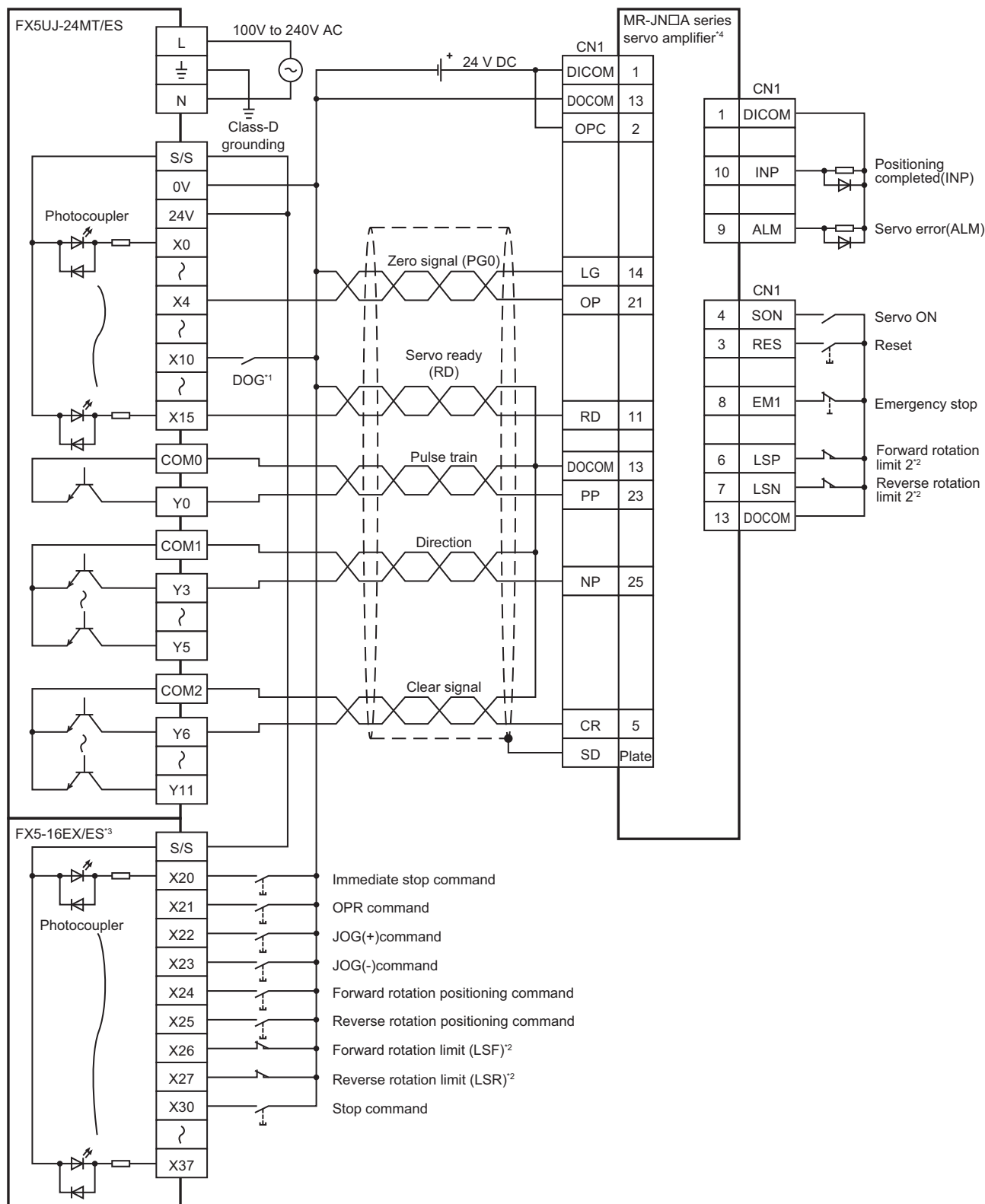

\*1 Near-point signal (DOG)

\*2 For details, refer to Page 963 Precautions.

\*3 I/O module are used in the connection example. Inputs and outputs built into the CPU module are available in place of I/O module.

\*4 Set the command pulse input form (PA13) of the MR-JN□A type servo amplifier to "211" (negative logic, signed pulse train, command input pulse train filter: 200kpps or less).

# FX5U CPU module

## ■PULSE/SIGN mode

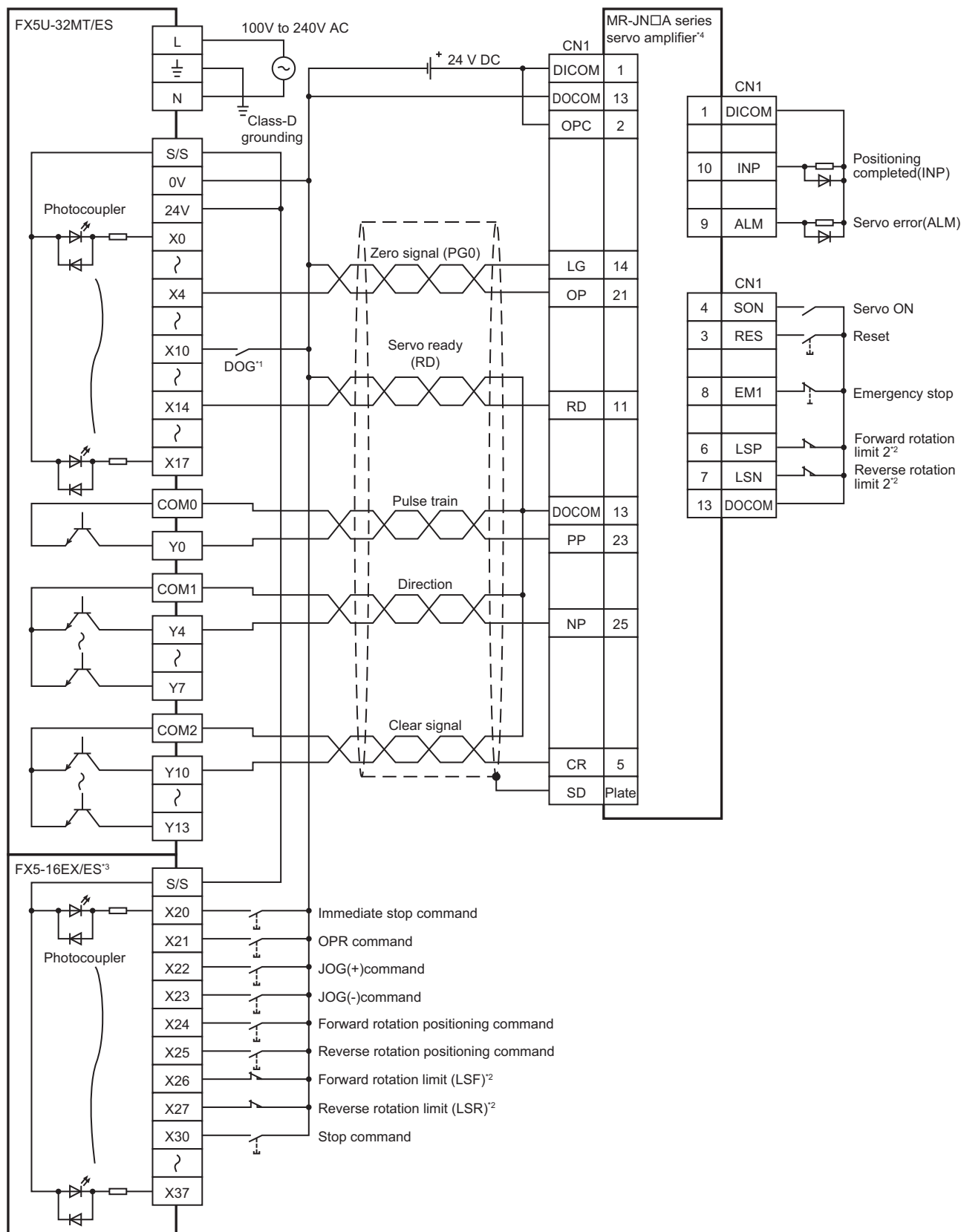

\*1 Near-point signal (DOG)

\*2 For details, refer to Page 963 Precautions.

\*3 I/O module are used in the connection example. Inputs and outputs built into the CPU module are available in place of I/O module.

\*4 Set the command pulse input form (PA13) of the MR-JN□A type servo amplifier to "211" (negative logic, signed pulse train, command input pulse train filter: 200kpps or less).



## ■ CW/CCW mode

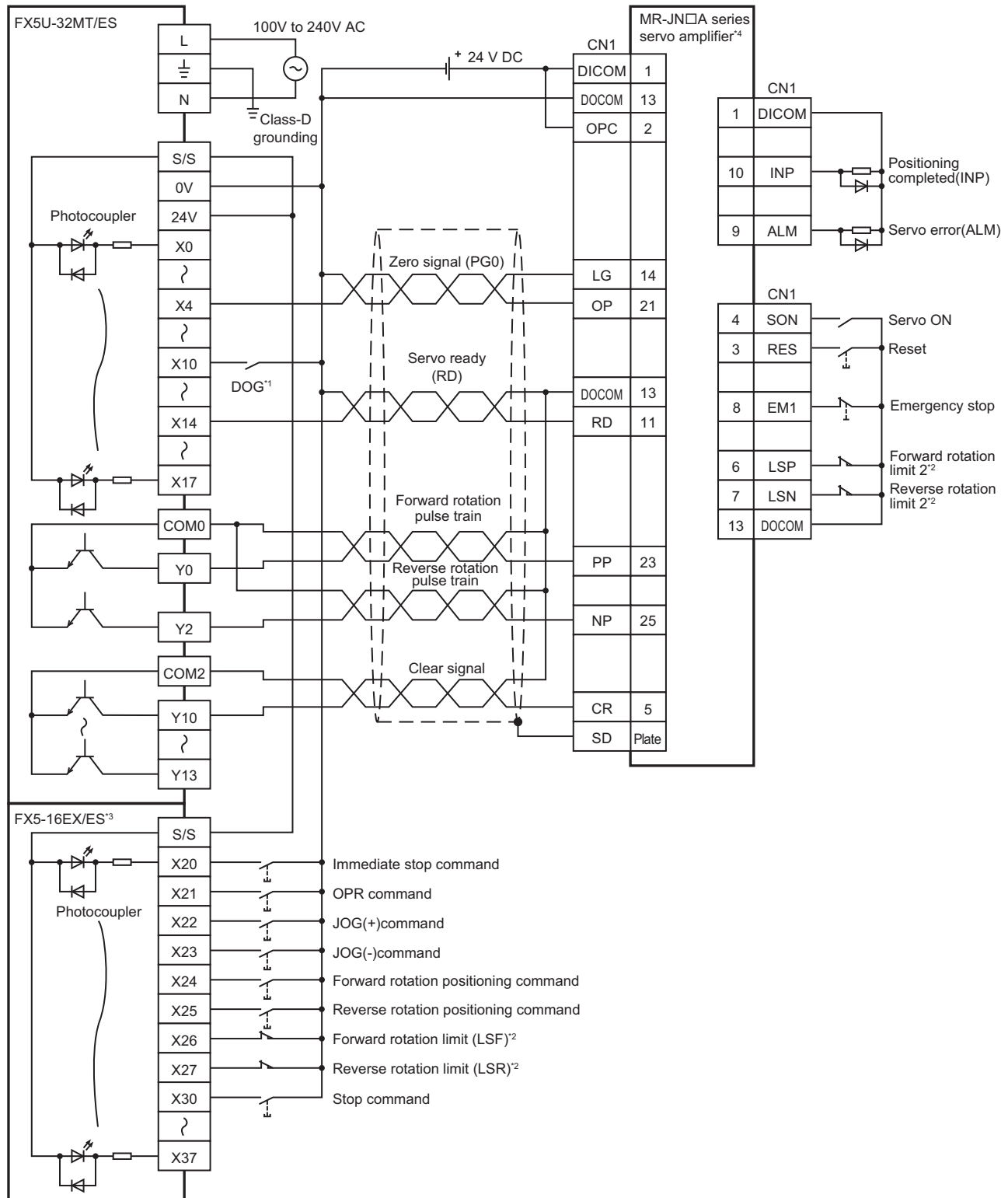

\*1 Near-point signal (DOG)

\*2 For details, refer to Page 963 Precautions.

\*3 I/O module are used in the connection example. Inputs and outputs built into the CPU module are available in place of I/O module.

\*4 Set the command pulse input form (PA13) of the MR-JN□A type servo amplifier to "210" (negative logic, forward rotation pulse train, reverse rotation pulse train, command input pulse train filter: 200kpps or less).



# FX5UC CPU module

## ■PULSE/SIGN mode

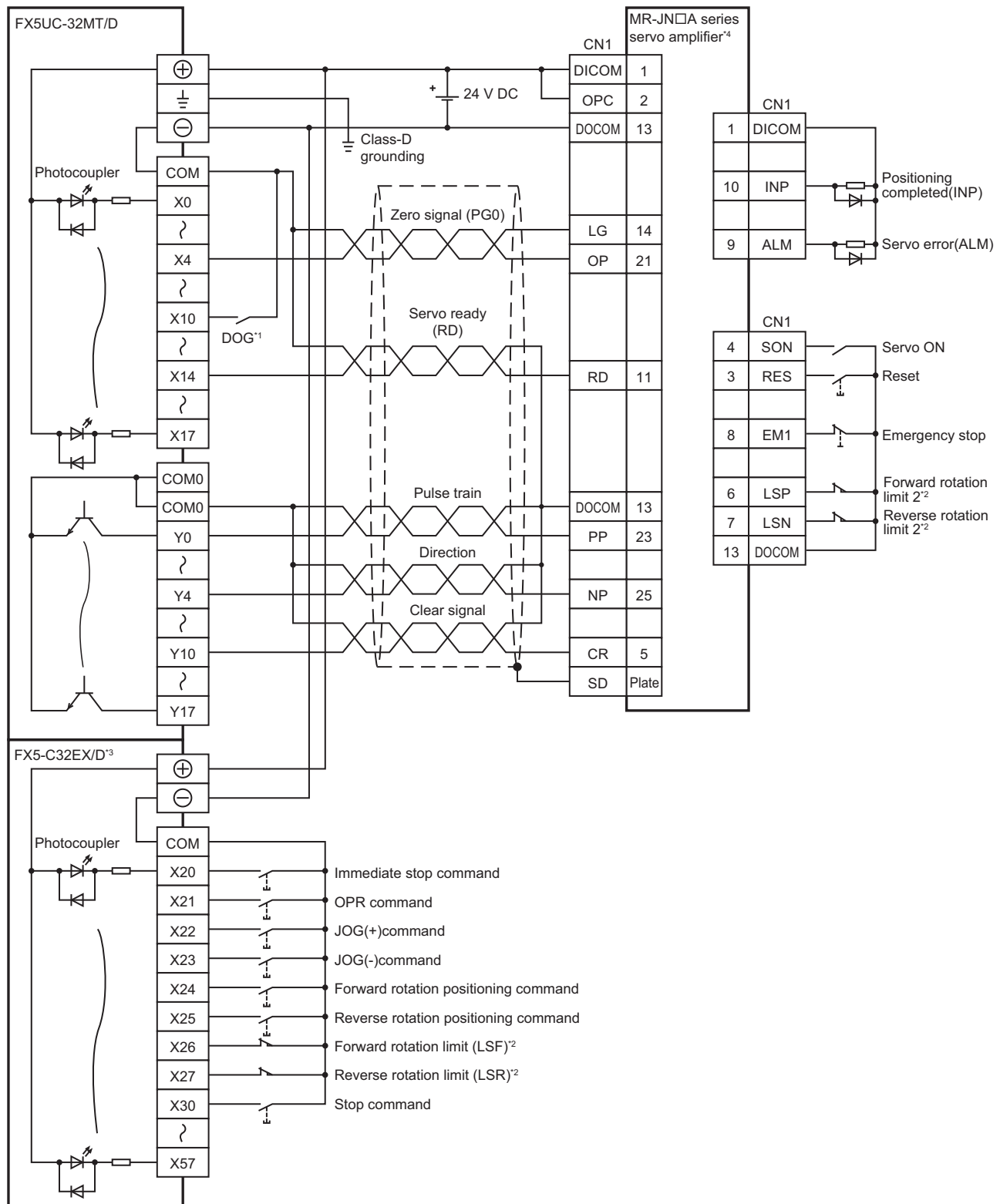

\*1 Near-point signal (DOG)

\*2 For details, refer to Page 963 Precautions.

\*3 I/O module are used in the connection example. Inputs and outputs built into the CPU module are available in place of I/O module.

\*4 Set the command pulse input form (PA13) of the MR-JN□A type servo amplifier to "211" (negative logic, signed pulse train, command input pulse train filter: 200kpps or less).

## ■ CW/CCW mode

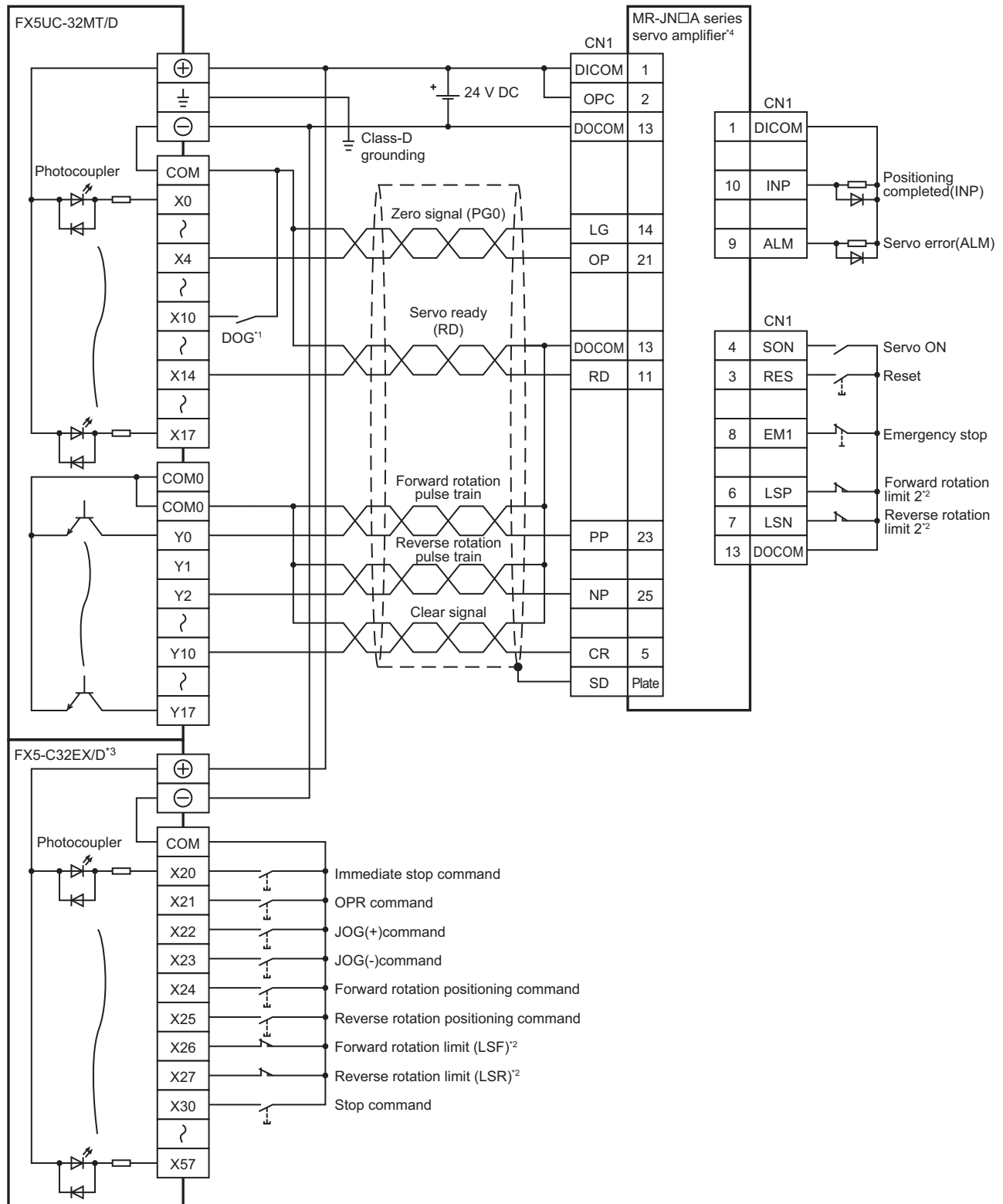

\*1 Near-point signal (DOG)

\*2 For details, refer to Page 963 Precautions.

\*3 I/O module are used in the connection example. Inputs and outputs built into the CPU module are available in place of I/O module.

\*4 Set the command pulse input form (PA13) of the MR-JN□A type servo amplifier to "210" (negative logic, forward rotation pulse train, reverse rotation pulse train, command input pulse train filter: 200kpps or less).

# High-speed pulse input/output module

## ■PULSE/SIGN mode

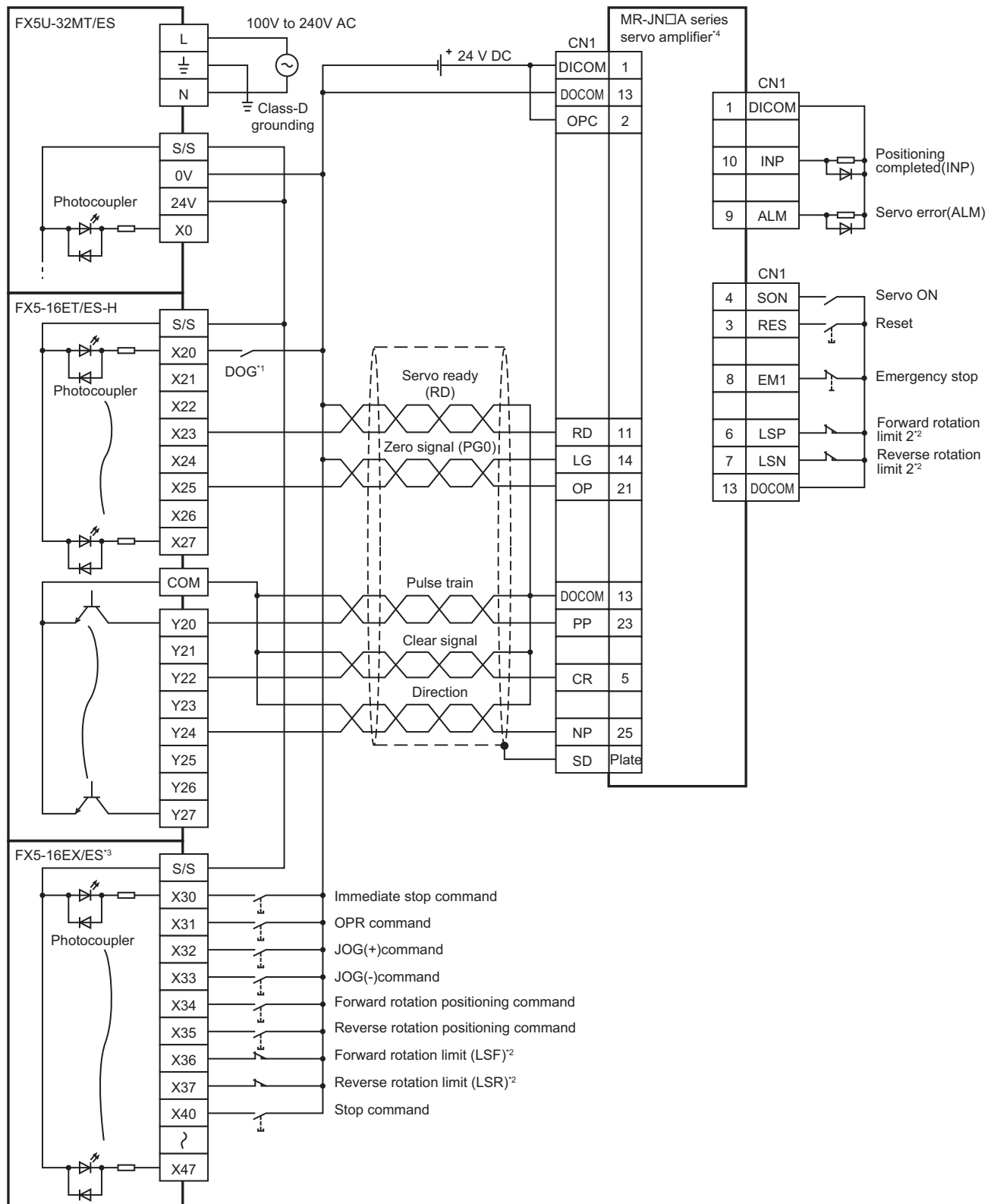

\*1 Near-point signal (DOG)

Any input other than high-speed pulse input/output module can also be used.

\*2 For details, refer to Page 963 Precautions.

\*3 I/O module are used in the connection example. Inputs built into the CPU module are available in place of I/O module.

\*4 Set the command pulse input form (PA13) of the MR-JN□A type servo amplifier to "211" (negative logic, signed pulse train, command input pulse train filter: 200kpps or less).



## ■ CW/CCW mode

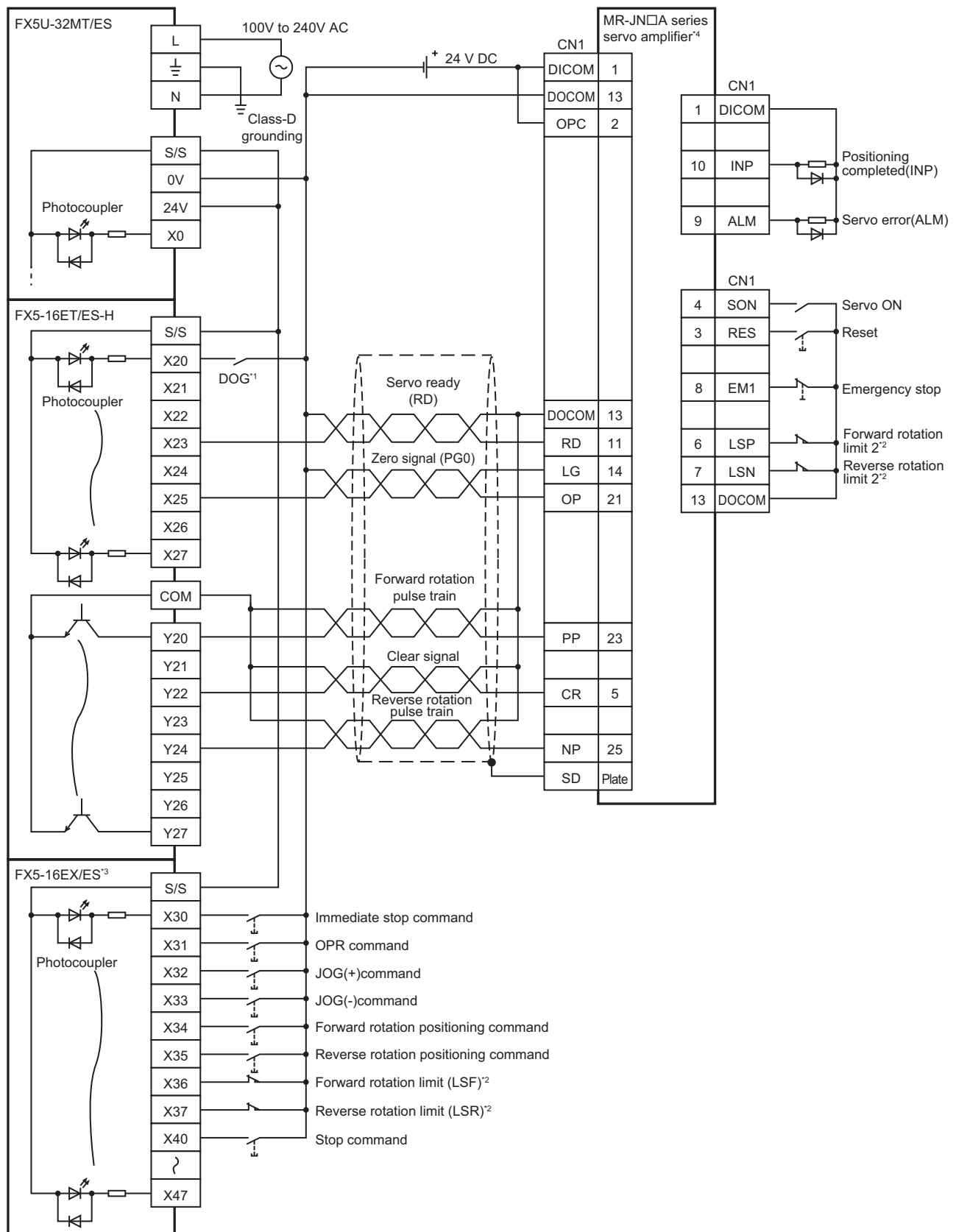

\*1 Near-point signal (DOG)

Any input other than high-speed pulse input/output module can also be used.

\*2 For details, refer to Page 963 Precautions.

\*3 I/O module are used in the connection example. Inputs built into the CPU module are available in place of I/O module.

\*4 Set the command pulse input form (PA13) of the MR-JN□A type servo amplifier to "210" (negative logic, forward rotation pulse train, reverse rotation pulse train, command input pulse train filter: 200kpps or less).

## Precautions

- Use a CPU module and I/O module with transistor output.
- Be sure to use the class-D grounding method (grounding resistance: 100  $\Omega$  or less).
- To ensure safety, use the forward rotation limit switch and the reverse rotation limit switch on both sides: the CPU module side and the servo amplifier side.

Note that the limit switches on the CPU module side should be activated slightly earlier than the limit switches on the servo amplifier side.

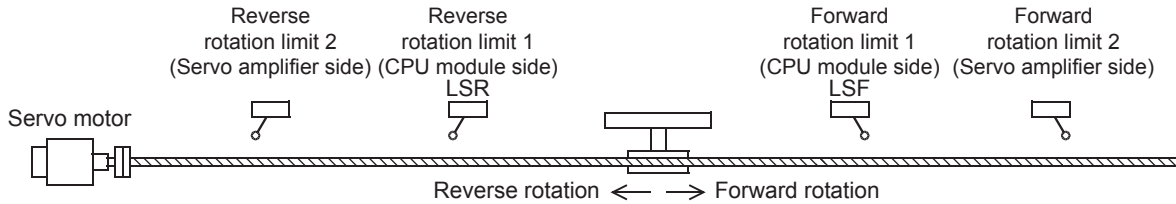

# Appendix 10 Substitute Functions

## File registers

To use a file register of the FX3 PLC, use functions of the FX5 PLC.

A file register is a device that sets an initial value to a data register that has the same device number. The values of the file registers set in the built-in memory or memory cassette are transferred collectively to the data registers when the power of the FX3 PLC is OFF→ON or the PLC is STOP→RUN.

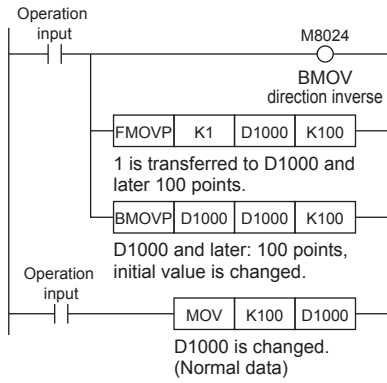
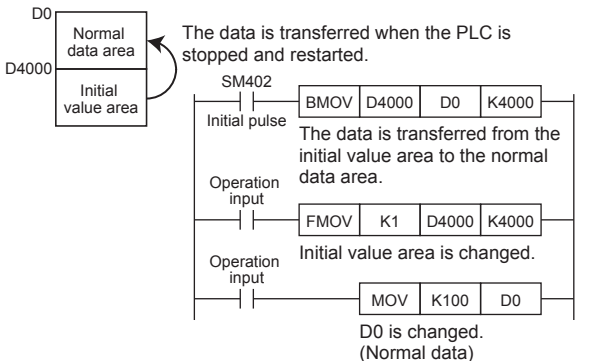
File registers function of FX3 PLC	Substitute function of FX5 PLC	Reference
<ul style="list-style-type: none"> <li>The initial value setting of the data register</li> <li>When the power is OFF→ON or the PLC is STOP→RUN, the data register is initialized.</li> </ul>	<p>The setting is possible with the device initial value setting. If the initial value is set, the data register is initialized when the power is OFF→ON, reset, or the PLC is STOP→RUN.</p>	Page 76
<p>The initial value of the data register (FX3 file register) can be changed by the BMOV instruction. When changed by something other than the BMOV instruction, it is treated as a normal data register. When the power is OFF→ON or the PLC is STOP→RUN, the value that is changed by the BMOV instruction is the initial value.</p> <p>■Program example When D1000 and later are used as FX3 file registers</p>  <p>When the above program is executed, the value of D1000 becomes 100. When the PLC is stopped and restarted, the initial value "1" specified by the BMOV instruction is stored in D1000 to D1099.</p>	<p>Divide data register area into initial value area and normal data area. When the PLC is STOP→RUN, transfer the data in the initial value area to the normal data area to use the initial value area as file registers. Use the latch function in the initial value area.</p> <p>■Data register area and program example When D4000 and later are the initial value area</p> <p>Data register area</p>  <p>When the above program is executed, the value of D0 becomes 100. When the PLC is stopped and restarted, the initial value "1" that is stored in the initial value area, D4000 to D7999, is transferred to the normal data area, D0 to D3999.</p>	Page 123

# Replacing PLSR/DPLSR instruction to DRVI/DDRVI instruction

The PLSR/DPLSR (pulse output with acceleration and deceleration control) instruction of FX3 can be replaced to the DRVI/DDRVI instruction.

The PLSR/DPLSR instruction can set the duration of time for acceleration and deceleration. Setting the duration of time for acceleration or deceleration before executing the DRVI/DDRVI instruction enables the DRVI/DDRVI instruction to substitute the PLSR/DPLSR instruction.

## Program example

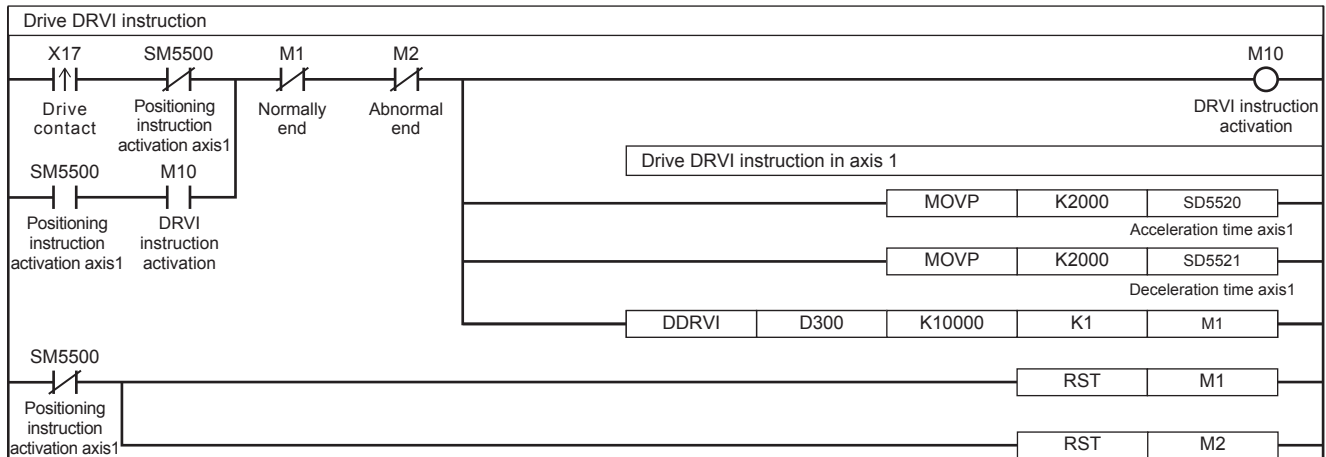

For the stop event, refer to [Page 429 Program example](#).

# Replacing ZRN/DZRN instruction to DSZR/DDSZR instruction

The ZRN/DZRN (OPR) instruction of FX3 can be replaced to the DSZR/DDSZR instruction.

With the OPR parameters as below, the operation of the DSZR/DDSZR instruction is the same as that of the ZRN/DZRN instruction. Other parameters can be set as desired. For each parameter, refer to [Page 364 POSITIONING PARAMETER](#).

OPR Parameter	Setting value	Reference	
Near-point Dog Signal Device No.	Same device	Page 390	
Zero Signal	Device No.	Page 391	
	OPR Zero Signal Counts		1
	Count Start Time		0: Near-point Dog Latter Part



# Appendix 11 Added and Enhanced Functions

This section describes added and enhanced functions of the CPU module and the engineering tool, as well as the firmware versions of the CPU module and software versions of the engineering tool corresponding to the functions.

The firmware version can be confirmed with module diagnosis (CPU diagnosis). Refer to the following manuals for details on diagnosing the module (CPU diagnosis).

📖 MELSEC iQ-F FX5S/FX5UJ/FX5U/FX5UC User's Manual (Hardware)

Refer to the 📖 GX Works3 Operating Manual for details on the software version.

## FX5S CPU module

Add/Change Function	Supported CPU module firmware version	Supported engineering tool software version	Reference
FX5S CPU module is supported.	From the first	"1.080J" or later	—
Number of conversion digits selection by SM705 is supported.	"1.010" or later	"1.095Z" or later	Page 776
SFC function is supported.	"1.010" or later	"1.095Z" or later	MELSEC iQ-F FX5 Programming Manual (Program Design)
Input interrupt delay function	"1.010" or later	"1.095Z" or later	Page 111
External input/output forced on/off function	"1.020" or later	"1.100E" or later	Page 135
Data logging file transfer function	"1.020" or later	"1.100E" or later	Page 181

## FX5UJ CPU module

Add/Change Function	Supported CPU module firmware version	Supported engineering tool software version	Reference
FX5UJ CPU module is supported.	From the first	"1.060N" or later	—
The following modules are supported. <ul style="list-style-type: none"> <li>FX5-SF-MU4T5</li> <li>FX5-SF-8DI4</li> </ul>	"1.010" or later	"1.075D" or later	MELSEC iQ-F FX5 Safety Extension Module User's Manual
The following modules are supported. <ul style="list-style-type: none"> <li>FX5-4A-ADP</li> </ul>	"1.010" or later	"1.075D" or later	Page 649
User Web page is supported.	"1.020" or later	"1.080J" or later	MELSEC iQ-F FX5 User's Manual (Communication) MELSEC iQ-R/MELSEC iQ-F Web Server Function Guide Book
Firmware update function	"1.030" or later	"1.075D" or later	Page 89
Data logging function supports a CSV file format.	"1.030" or later	"1.085P" or later	Page 147 Page 913
1E frame of SLMP is supported.	"1.030" or later	"1.085P" or later	MELSEC iQ-F FX5 User's Manual (Communication)
File transfer function instruction (Sending FTP client files) is supported.	"1.030" or later	"1.085P" or later	MELSEC iQ-F FX5 User's Manual (Communication)
Supported models for the simple CPU communication function are added.	"1.030" or later	"1.085P" or later	MELSEC iQ-F FX5 User's Manual (Communication)
File operation instructions is supported.	"1.030" or later	"1.085P" or later	MELSEC iQ-F FX5 Programming Manual (Instructions, Standard Functions/Function Blocks)
Unicode string data transfer instruction is supported.	"1.030" or later	"1.085P" or later	MELSEC iQ-F FX5 Programming Manual (Instructions, Standard Functions/Function Blocks)
Unicode character string to Shift JIS character string convert instruction is supported.	"1.030" or later	"1.085P" or later	MELSEC iQ-F FX5 Programming Manual (Instructions, Standard Functions/Function Blocks)
Shift JIS character string to Unicode character string convert instruction (without byte order mark) is supported.	"1.030" or later	"1.085P" or later	MELSEC iQ-F FX5 Programming Manual (Instructions, Standard Functions/Function Blocks)



Add/Change Function	Supported CPU module firmware version	Supported engineering tool software version	Reference
Shift JIS character string to Unicode convert instruction (with byte order mark) is supported.	"1.030" or later	"1.085P" or later	MELSEC iQ-F FX5 Programming Manual (Instructions, Standard Functions/Function Blocks)
The high-speed pulse I/O module is supported.	"1.030" or later	"1.085P" or later	Page 331
Scan time clear function	"1.030" or later	"1.085P" or later	Page 775
Number of conversion digits selection by SM705 is supported.	"1.040" or later	"1.090U" or later	Page 776
SFC function is supported.	"1.050" or later	"1.095Z" or later	MELSEC iQ-F FX5 Programming Manual (Program Design)
Input interrupt delay function	"1.050" or later	"1.095Z" or later	Page 111
External input/output forced on/off function	"1.060" or later	"1.100E" or later	Page 135
Data logging file transfer function	"1.060" or later	"1.100E" or later	Page 181

## FX5U/FX5UC CPU module

Add/Change Function	Supported CPU module firmware version	Supported engineering tool software version	Reference
The following module is supported. • FX5-4AD-ADP	From the first version	"1.007H" or later	Page 649
The number of settable high-speed comparison tables was changed from maximum 4 to 32.	"1.015" or later <sup>*1</sup>	"1.015R" or later	Page 254
The number of high-speed comparisons was changed from 4 to 32.	"1.015" or later <sup>*1</sup>	"1.015R" or later	Page 284
The following modules are supported. • FX5-16ET/ES-H • FX5-16ET/ESS-H	"1.030" or later	"1.025B" or later	Page 232
Interrupt input signal 1 high-speed mode is added	"1.030" or later	"1.025B" or later	Page 381
All module reset when a stop error occurs is added	"1.030" or later	"1.025B" or later	Page 383
Positioning table data retaining function is added	"1.030" or later	"1.025B" or later	Page 490
Firmware update function	From the first version <sup>*2</sup>	— <sup>*3</sup>	Page 89
Data logging function	"1.040" or later <sup>*4</sup>	"1.64S" or later <sup>*5</sup>	Page 147
Event history function	"1.040" or later <sup>*6</sup>	"1.030G" or later	Page 130
Internal buffer capacity setting	"1.040" or later <sup>*4</sup>	"1.030G" or later	Page 206
PID control operation setting (ACT) • Overshoot suppression setting • Hunting suppression setting	"1.040" or later	"1.030G" or later	Page 571
The following modules are supported. • FX5-4AD-PT-ADP • FX5-4AD-TC-ADP	"1.040" or later	"1.030G" or later	Page 649
File transfer function (FTP server)	"1.040" or later <sup>*4*7</sup>	"1.030G" or later	MELSEC iQ-F FX5 User's Manual (Communication)
iQ Sensor Solution • Automatic detection of connected devices • Communication setting reflection of Ethernet device • Sensor parameter read/write	"1.040" or later	"1.030G" or later	iQ Sensor Solution Reference Manual
CC-Link IE Field Network Basic function	"1.040" or later	"1.030G" or later	CC-Link IE Field Network Basic Reference Manual
Data backup/restoration function	"1.045" or later <sup>*8</sup>	—	Page 206
Memory dump function	"1.050" or later <sup>*4</sup>	"1.035M" or later	Page 197
IP filter function	"1.050" or later	"1.035M" or later	MELSEC iQ-F FX5 User's Manual (Communication)

Add/Change Function	Supported CPU module firmware version	Supported engineering tool software version	Reference
Parallel link function	"1.050" or later	"1.035M" or later	MELSEC iQ-F FX5 User's Manual (Communication)
The following module is supported. • FX5-CCL-MS	"1.050" or later	"1.035M" or later	MELSEC iQ-F FX5 CC-Link System Master/Intelligent Device Module User's Manual
The following module is supported. • FX5-20PG-P	"1.050" or later	"1.035M" or later	Page 331
The following modules are supported. • FX5-8AD	"1.050" or later	"1.035M" or later	MELSEC iQ-F FX5 Analog Module User's Manual
The following modules are supported. • FX5-4LC	"1.050" or later	"1.035M" or later	MELSEC iQ-F FX5 Temperature Control Module User's Manual
The following module is supported. • FX5-ASL-M	"1.050" or later	"1.035M" or later	MELSEC iQ-F FX5 AnyWireASLINK System Master Module User's Manual
Real-time monitor function	"1.060" or later	*9	Page 208
Support extended file register function	"1.060" or later <sup>4</sup>	"1.040S" or later	Page 65
MODBUS/TCP communication function	"1.060" or later	"1.040S" or later	MELSEC iQ-F FX5 User's Manual (Communication)
Time setting function (SNTP client)	"1.060" or later	"1.040S" or later	MELSEC iQ-F FX5 User's Manual (Communication)
Web server function	"1.060" or later	"1.040S" or later	MELSEC iQ-F FX5 User's Manual (Communication) MELSEC iQ-R/MELSEC iQ-F Web Server Function Guide Book
Support S(P).DEVL, SP.DEVST, ERREAD, ERWRITE, ERINIT and RTM instruction	"1.060" or later <sup>10</sup>	"1.040S" or later	MELSEC iQ-F FX5 Programming Manual (Instructions, Standard Functions/Function Blocks)
Support "Use MC/MCR for control of EN" of the subroutine type FB	"1.060" or later	"1.040S" or later	GX Works3 Operating Manual
The following modules are supported. • FX5-4AD • FX5-4DA	"1.050" or later	"1.040S" or later	MELSEC iQ-F FX5 Analog Module User's Manual
During IP address duplication with the device on the same network, the operation was improved to output the information of the external device with duplicated IP address.	"1.061" or later	—	MELSEC iQ-F FX5 User's Manual (Communication)
Keep of latch label during PC write by SM9353	"1.065" or later	—	Page 126
Expanding the number of input/output points to 384 points.	"1.100" or later	"1.047Z" or later	MELSEC iQ-F FX5S/FX5UJ/FX5U/FX5UC User's Manual (Hardware)
Removing the limitation on the number of remote I/O points. (384 points) (However, the total number of remote I/O points and input/output points is 512 points or less.)	"1.100" or later	"1.047Z" or later	MELSEC iQ-F FX5S/FX5UJ/FX5U/FX5UC User's Manual (Hardware)
Expanding the program capacity up to 128000 steps.	"1.100" or later	"1.047Z" or later	MELSEC iQ-F FX5S/FX5UJ/FX5U/FX5UC User's Manual (Hardware)
Divided writing of the program and program restoration information of online change	"1.100" or later	"1.047Z" or later	Page 107
User Web page is supported.	"1.100" or later	"1.047Z" or later	MELSEC iQ-F FX5 User's Manual (Communication) MELSEC iQ-R/MELSEC iQ-F Web Server Function Guide Book
The following module is supported. • FX5-20PG-D	"1.050" or later	"1.050C" or later	MELSEC iQ-F FX5 Positioning Module User's Manual
The following module is supported. • FX5-ENET	"1.110" or later	"1.050C" or later	MELSEC iQ-F FX5 Ethernet Module User's Manual

Add/Change Function	Supported CPU module firmware version	Supported engineering tool software version	Reference
The following module is supported. • FX5-DP-M	"1.110" or later	"1.050C" or later	MELSEC iQ-F FX5 PROFIBUS-DP Master Module User's Manual
Expanding the number of remote I/O station of CC-Link IE field network Basic from 6 to 16 stations.	"1.110" or later	"1.050C" or later	MELSEC iQ-F FX5S/FX5UJ/FX5U/ FX5UC User's Manual (Hardware)
1C frame of MC protocol	"1.110" or later	"1.050C" or later	MELSEC iQ-F FX5 User's Manual (Communication)
The following modules support the module diagnostics and event history function. • FX5-20PG-P*11 • FX5-20PG-D*11 • FX5-ENET	"1.110" or later	"1.050C" or later	Page 130
Simple CPU communication function	"1.110" or later	"1.050C" or later	MELSEC iQ-F FX5 User's Manual (Communication)
The following modules are supported. • FX5-SF-MU4T5 • FX5-SF-8DI4	"1.200" or later	"1.060N" or later	MELSEC iQ-F FX5 Safety Extension Module User's Manual
Down counting for LC0 to LC34 is supported.	"1.201" or later	"1.060N" or later	MELSEC iQ-F FX5 Programming Manual (Instructions, Standard Functions/Function Blocks)
The area capacity in the device/label memory area setting (standard area) increased from 48K to 63K.	"1.210" or later	"1.065T" or later	Page 79
Data logging function supports a CSV file format.	"1.210" or later*12	"1.106K" or later*5	Page 147 Page 913
The following modules are supported. • FX5-CCLGN-MS	"1.210" or later	"1.065T" or later	MELSEC iQ-F FX5 CC-Link IE TSN Master/Local Module User's Manual
The following modules support the parameter setting function by the program. • FX5-CCL-MS	"1.210" or later	"1.065T" or later	MELSEC iQ-F FX5 CC-Link System Master/Intelligent Device Module User's Manual
1E frame of SLMP is supported.	"1.210" or later	—	MELSEC iQ-F FX5 User's Manual (Communication)
File transfer function instruction (Sending FTP client files) is supported.	"1.210" or later	"1.065T" or later	MELSEC iQ-F FX5 User's Manual (Communication)
Supported models for the simple CPU communication function are added.	"1.210" or later	"1.065T" or later	MELSEC iQ-F FX5 User's Manual (Communication)
SFC programs are supported.	"1.220" or later	"1.070Y" or later	MELSEC iQ-F FX5 Programming Manual (Program Design)
Instructions for SFC programs are supported.	"1.220" or later	"1.070Y" or later	MELSEC iQ-F FX5 Programming Manual (Instructions, Standard Functions/Function Blocks)
The following modules are supported. • FX5-40SSC-G • FX5-80SSC-G	"1.230" or later	"1.072A" or later	MELSEC iQ-F FX5 Motion Module/ Simple Motion Module User's Manual (Startup)
Firmware update function using engineering tool.	"1.240" or later	"1.075D" or later	Page 95
File operation instructions is supported.	"1.240" or later	"1.075D" or later	MELSEC iQ-F FX5 Programming Manual (Instructions, Standard Functions/Function Blocks)
Unicode string data transfer instruction is supported.	"1.240" or later	"1.075D" or later	MELSEC iQ-F FX5 Programming Manual (Instructions, Standard Functions/Function Blocks)
Unicode character string to Shift JIS character string convert instruction is supported.	"1.240" or later	"1.075D" or later	MELSEC iQ-F FX5 Programming Manual (Instructions, Standard Functions/Function Blocks)
Shift JIS character string to Unicode character string convert instruction (without byte order mark) is supported.	"1.240" or later	"1.075D" or later	MELSEC iQ-F FX5 Programming Manual (Instructions, Standard Functions/Function Blocks)



Add/Change Function	Supported CPU module firmware version	Supported engineering tool software version	Reference
Shift JIS character string to Unicode convert instruction (with byte order mark) is supported.	"1.240" or later	"1.075D" or later	MELSEC iQ-F FX5 Programming Manual (Instructions, Standard Functions/Function Blocks)
Retrieving FTP client files instruction is supported.	"1.240" or later	"1.075D" or later	MELSEC iQ-F FX5 Programming Manual (Instructions, Standard Functions/Function Blocks)
The following module is supported. • FX5-4A-ADP	"1.240" or later	"1.075D" or later	Page 649
The following modules are supported. • FX5-40SSC-G Ver.1.001 • FX5-80SSC-G Ver.1.001	"1.250" or later	"1.080J" or later	MELSEC iQ-F FX5 Motion Module User's Manual (CC-Link IE TSN)
The processing time when a file is specified for the SP.FMOVE file operation instruction was improved.	"1.250" or later	"1.080J" or later	Page 912
Scan time clear function	"1.270" or later	"1.085P" or later	Page 775
Heating-cooling PID control function	"1.280" or later	"1.090U" or later	Page 611
Number of conversion digits selection by SM705 is supported.	"1.280" or later	"1.090U" or later	Page 776
Heating/cooling PID control function supports the overlap/dead band function.	"1.290" or later	"1.095Z" or later	Page 601
Input interrupt delay function	"1.290" or later	"1.095Z" or later	Page 111
External input/output forced on/off function	"1.300" or later	"1.100E" or later	Page 135
Data logging file transfer function	"1.300" or later	"1.100E" or later	Page 181

\*1 Supported with CPU module serial No. 158\*\*\*\* or later.

\*2 Data memory (device comment file) save/recovery is supported with "1.030" or later.

Data memory (device comment file) recovery retry is supported with "1.045" or later.

File password setting for the firmware update prohibited file is supported with "1.045" or later.

Data memory (restored information files, parameter files) save/recovery/recovery retry is supported with "1.060" or later.

\*3 Writing firmware update prohibited files is supported with "1.030G" or later.

\*4 Supported with CPU module serial No. 16Y\*\*\*\* or later.

\*5 Indicates the compatible software version of CPU Module Logging Configuration Tool and GX LogViewer.

\*6 Saving the event history file to the SD memory card is supported from CPU module serial No. 16Y\*\*\*\* or later.

\*7 Write the file, delete the file, remote password and file password is supported with "1.050" or later.

\*8 Data backup function is supported from CPU module serial No. 16Y\*\*\*\* or later.

The data memory for the backup/restoration target data is supported from "1.050" or later.

\*9 GX Works3: "1.040S" or later

GX LogViewer: "1.76E" or later

\*10 ERREAD, ERWRITE, ERINIT instruction is supported from CPU module serial No. 16Y\*\*\*\* or later.

\*11 Supported from the firmware version 1.010 or later of FX5-20PG-P and FX5-20PG-D.

\*12 Supported with CPU module serial No. 17X\*\*\*\* or later.

- 
- To update the firmware of the FX5U/FX5UC CPU module to version "1.100" or later, use the CPU module with serial No. as follows.
    - FX5UC-32MT/DS-TS and FX5UC-32MT/DSS-TS: Serial No.178\*\*\*\*
    - FX5U/FX5UC CPU module other than the above: Serial No.17X\*\*\*\*
  - For the FX5U/FX5UC CPU module with the serial No. 2114001 or later, downgrading to previous firmware version "1.220" or earlier cannot be performed. Update error (3040H) will occur and the firmware will not be updated.
  - For the FX5UJ CPU module with the serial No. 2154001 or later, downgrading to previous firmware version "1.010" or earlier cannot be performed. Update error (3040H) will occur and the firmware will not be updated.
  - For the FX5UJ-□MT/D□ and the FX5UJ-□MR/D□, downgrading to previous firmware version "1.050" or earlier cannot be performed. Update error (3040H) will occur and the firmware will not be updated.
-

# INDEX

---

## 0 to 9

---

- 1 speed positioning (absolute address specification) . . . . . 493
- 1 speed positioning (relative address specification) . . . . . 491
- 1-speed positioning . . . . . 350
- 2-speed positioning . . . . . 350

## A

---

- A/D conversion enable/disable setting function . . . . . 547,666
- A/D conversion method . . . . . 548,669
- Absolute position detection system . . . . . 483
- Absolute positioning . . . . . 431
- Acceleration time . . . . . 378
- Accuracy of A/D conversion . . . . . 544,657
- Accuracy of D/A conversion . . . . . 658
- All module reset when a stop error occurs . . . . . 363
- Analog output HOLD/CLEAR function . . . . . 559,711
- Analog output test when CPU module is in STOP status function . . . . . 560,722
- Annunciator (F) . . . . . 55
- Axis to be interpolated . . . . . 395

## B

---

- Basic setting . . . . . 365
- Bias speed . . . . . 377
- Block password . . . . . 145
- Boot operation . . . . . 230

## C

---

- Character string constant . . . . . 75
- Clear signal output . . . . . 389
- Clock function . . . . . 141
- Command speed . . . . . 375
- Command speed change during positioning operation . . . . . 360
- Complete flag . . . . . 400
- Condition jump . . . . . 507
- Constant . . . . . 74
- Constant scan . . . . . 116
- Continuous logging . . . . . 163
- Continuous operation . . . . . 521
- Control method . . . . . 490
- Convergence detection function . . . . . 691
- Conversion enable/disable setting function . . . . . 724
- Counter (C/LC) . . . . . 60
- CPU parameter . . . . . 897
- Creep speed . . . . . 389
- Current input characteristic . . . . . 654
- Current output characteristic . . . . . 656
- Current speed . . . . . 376,396
- CW/CCW mode . . . . . 371

## D

---

- D/A conversion enable/disable function . . . . . 558,703
- D/A output enable/disable setting function . . . . . 558,712

- Data logging file . . . . . 169
- Data memory . . . . . 46
- Data register (D) . . . . . 62
- Deceleration time . . . . . 378
- Decimal . . . . . 74
- Decimal constant (K) . . . . . 74
- Detection of absolute position . . . . . 363
- Deviation detection between channel function . . . . . 694
- Device/label access service processing setting . . . . . 83
- Device/label memory . . . . . 47
- Digital clipping function . . . . . 551,676
- Digital operation value . . . . . 547,661,663
- Digital output value . . . . . 546,661
- Disconnection detection function . . . . . 672,713,730
- Dog search function . . . . . 356
- Dwell time . . . . . 358,393

## E

---

- END processing . . . . . 27
- ERINIT instruction . . . . . 66
- ERREAD instruction . . . . . 66
- ERWRITE instruction . . . . . 66
- Event execution type program . . . . . 34
- Event history function . . . . . 130,556,564,754
- Execution type of program . . . . . 29
- External power supply disconnection detection function . . . . . 716
- External start signal . . . . . 383

## F

---

- File password . . . . . 145
- File Register (R/ER) . . . . . 65
- Files . . . . . 50
- Fixed scan execution mode . . . . . 33
- Fixed scan execution type program . . . . . 30
- Forward limit . . . . . 359,384
- FX3-compatible high-speed counter . . . . . 288
- FX3-compatible pulse catch . . . . . 313

## G

---

- Global pointer . . . . . 71

## H

---

- Hexadecimal . . . . . 74
- Hexadecimal constant (H) . . . . . 74
- High speed I/O parameter . . . . . 364
- High-speed comparison table . . . . . 254
- High-speed counter . . . . . 232
- High-speed counter (normal mode) . . . . . 246
- High-speed counter (pulse density measurement mode) . . . . . 249
- High-speed counter (rotational speed measurement mode) . . . . . 251
- High-speed OPR . . . . . 349
- High-speed timer . . . . . 58

<b>I</b>	
I/O refresh . . . . .	27
Index Register (Z/LZ) . . . . .	64
Index register setting . . . . .	65
Indirect specification . . . . .	73
Initial device value . . . . .	75
Initial execution type program . . . . .	29
Initial scan time . . . . .	28
Input (X) . . . . .	54
Input check . . . . .	368
Internal buffer . . . . .	180
Internal buffer capacity setting . . . . .	206
Internal relay (M) . . . . .	55
Interpolation operation (absolute address specification target axis) . . . . .	518
Interpolation operation (absolute address specification) . . . . .	514
Interpolation operation (relative address specification target axis) . . . . .	513
Interpolation operation (relative address specification) . . . . .	509
Interpolation speed specified method . . . . .	395
Interrupt 1-speed positioning . . . . .	352,440,495
Interrupt 2-speed positioning . . . . .	353
Interrupt cause . . . . .	72
Interrupt Counts . . . . .	393
Interrupt input signal 1 . . . . .	381
Interrupt input signal 2 . . . . .	394,500
Interrupt pointer (I) . . . . .	71
Interrupt program . . . . .	39
Interrupt stop . . . . .	351
Interrupt stop (absolute address specification) . . . . .	505
Interrupt stop (relative address specification) . . . . .	502
IP filter . . . . .	145

<b>J</b>	
Jump destination table No. . . . .	394

<b>L</b>	
Label . . . . .	77
Latch . . . . .	123
Latch (1) . . . . .	123
Latch (2) . . . . .	123
Latch clear . . . . .	126
Latch relay (L) . . . . .	55
Link register (W) . . . . .	62
Link relay (B) . . . . .	55
Link special register (SW) . . . . .	62
Link special relay (SB) . . . . .	57
LOGTRG instruction . . . . .	169
LOGTRGR instruction . . . . .	191
Low-speed timer . . . . .	58

<b>M</b>	
M No. for jump condition . . . . .	394
Maximum speed . . . . .	377
Maximum value/minimum value hold function . . . . .	554,693,737
Measured temperature value . . . . .	665
Mechanical OPR . . . . .	349,411
Memory card parameter . . . . .	906
Memory configuration . . . . .	46

Memory dump file . . . . .	202
Memory dump function . . . . .	197
Memory dump status . . . . .	202
Missing data . . . . .	189
Module access device . . . . .	63
Module parameter . . . . .	898
Movement amount per rotation . . . . .	374
Multiple axes simultaneous activation . . . . .	363
Multiple interrupt . . . . .	109
Multiple point output, high-speed comparison table . . . . .	257
Multiple-axis table operation . . . . .	476
Multiple-table operation . . . . .	468
Multi-speed operation . . . . .	351

<b>N</b>	
Near-point dog Signal . . . . .	390
Nesting (N) . . . . .	70
No positioning . . . . .	490
No. of Pulse per Rotation . . . . .	374

<b>O</b>	
Offset/gain initialization function . . . . .	702,721,752
Offset/gain setting function . . . . .	697,716,746
Online change . . . . .	106
Operand . . . . .	364
Operation at the time of a transition to RUN. . . . .	188
OPR direction . . . . .	387
OPR dwell time . . . . .	390
OPR speed . . . . .	388
OPR zero signal count . . . . .	358
Output (Y) . . . . .	54
Output confirmation . . . . .	369
Over scale detection function . . . . .	550,674

<b>P</b>	
PAUSE . . . . .	44
Pointer (P) . . . . .	70
Position data magnification . . . . .	375
Positioning address . . . . .	378
Positioning address change during positioning operation . . . . .	359
Positioning table data retaining function . . . . .	490
Priority for interrupt cause . . . . .	72
Process alarm . . . . .	682,739
Pulse catch . . . . .	308
Pulse decelerate and stop . . . . .	361
Pulse decelerate and stop command . . . . .	383
Pulse output mode . . . . .	370
Pulse output stop command . . . . .	382
Pulse width measurement . . . . .	297
Pulse Y Output . . . . .	405
PULSE/SIGN mode . . . . .	370
PWM . . . . .	319

<b>R</b>	
Range switching function . . . . .	667,704
Rate alarm . . . . .	685,742
Real constant (E) . . . . .	74
Relative positioning . . . . .	421
Remaining distance operation . . . . .	362,385
Remote operation . . . . .	118

Remote password . . . . .	145
Remote PAUSE . . . . .	120
Remote RESET . . . . .	121
Remote RUN . . . . .	118
Remote STOP . . . . .	118
Retentive timer (ST) . . . . .	58
Reverse limit . . . . .	359,384
Rotation direction setting . . . . .	372
Routine timer . . . . .	58
RUN status. . . . .	44

## S

---

Scaling function . . . . .	552,561,678,709
Scan execution type program . . . . .	30
Scan monitoring function . . . . .	114
Scan time. . . . .	27
Scan time monitoring time setting . . . . .	114
SD memory card. . . . .	49
SD memory card forced stop . . . . .	228
Security function . . . . .	145
Security key authentication . . . . .	145
Shift function . . . . .	553,562,689,705
Simple linear interpolation operation (2-axis simultaneous start) . . . . .	355
Single-table operation . . . . .	459
Special device . . . . .	364
Special register (SD) . . . . .	63
Special relay (SM). . . . .	62
Stand-by type program . . . . .	37
Starting point address . . . . .	388
Step relay (S) . . . . .	57
Stepping operation . . . . .	519
STOP status. . . . .	44
Storage file. . . . .	179
Subroutine program . . . . .	38
System clock . . . . .	144
System device . . . . .	62
System parameter. . . . .	897

## T

---

Table data . . . . .	489
Table operation. . . . .	354
Table shift command . . . . .	396
Table transition variable speed operation. . . . .	500
Temperature conversion method . . . . .	733
Temperature resistance choice function . . . . .	725
Temperature unit choice function . . . . .	736
Thermocouple type choice function. . . . .	727
Time setting . . . . .	141
Time zone . . . . .	143
Timer (T/ST). . . . .	57
Trigger condition . . . . .	168
Trigger instruction . . . . .	169
Trigger logging . . . . .	163

## U

---

Unit setting . . . . .	373
User device . . . . .	54

## V

---

Variable speed operation. . . . .	354,450,498
Voltage input characteristic . . . . .	653
Voltage output characteristic . . . . .	655

## W

---

Warning output function. . . . .	555,562,682,707,739
Watchdog timer . . . . .	114

## Z

---

Zero signal. . . . .	391
----------------------	-----



# REVISIONS

\*The manual number is given on the bottom left of the back cover.

Revision date	Revision	Description
October 2014	A	First Edition
January 2015	B	<p>■Added functions Fixed scan execution type program, Online change, PID control function, FX3-compatible high-speed counter function, Routine timer</p> <p>■Added or modified parts Section 1.3, 3.1, 3.2, Chapter 4, 7, 8, 9, 12, 13, 17, Section 19.2, Chapter 20, Section 21.2, Appendix 1, 2, 3, 4</p>
April 2015	C	A part of the cover design is changed.
May 2016	D	<p>■Added modules FX5U-32MR/DS, FX5U-32MT/DS, FX5U-32MT/DSS, FX5UC-64MT/D, FX5UC-64MT/DSS, FX5UC-96MT/D, FX5UC-96MT/DSS, FX5-16ET/ES-H, FX5-16ET/ESS-H</p> <p>■Added or modified parts RELEVANT MANUALS, TERMS, Section 1.1, 1.5, Chapter 4, Section 7.1, Section 9.3, 9.6, 9.8, 11.1, Chapter 12, Section 14.2, 15.1, Chapter 18, 19, Section 21.2, 21.4, 21.7, 21.9, 21.10, Chapter 22, Appendix, WARRANTY</p>
October 2016	E	<p>■Added modules FX5U-64MR/DS, FX5U-64MT/DS, FX5U-64MT/DSS, FX5U-80MR/DS, FX5U-80MT/DS, FX5U-80MT/DSS</p> <p>■Added functions Firmware update function, Data logging function, Event history function, Internal buffer capacity setting</p> <p>■Added or modified parts Terms, Section 1.1, 1.4, 1.5, 3.1, 3.2, Chapter 4, 5, 7, Section 10.3, 10.5, 10.6, 10.7, 10.8, 12.1, 13.2, Chapter 14, Section 17.1, Chapter 19, 20, Section 22.1, 23.2, 24.2, Appendix 1, 2, 3, 4, 5, 6, 7, 9</p>
October 2016	F	<p>■Added or modified parts Chapter 5, Section 19.2</p>
January 2017	G	<p>■Added functions Data backup/restoration function</p> <p>■Added or modified parts Section 3.2, Chapter 4, 5, Section 7.1, 8.1, 17.1, Chapter 19, Section 20.2, Chapter 21, Section 23.1, Appendix 1, 2, 3, 9</p>
April 2017	H	<p>■Added functions Memory dump function</p> <p>■Added or modified parts RELEVANT MANUALS, TERMS, Chapter 3, 4, 14, Section 17.1, Chapter 19, 20, 22, Appendix 1, 2, 3, 4, 9</p>
October 2017	J	<p>■Added functions Real-time monitor function, extended file register</p> <p>■Added or modified parts RELEVANT MANUALS, TERMS, Chapter 3, 4, 5, 14, Section 17.1, 20.4, Chapter 21, 23, Section 25.1, 27.1, 27.6, Appendix 1, 2, 3, 4, 9</p>
April 2018	K	<p>■Added functions Keep of latch label during PC write</p> <p>■Added or modified parts Section 10.8, 16.5, 22.1, Appendix 1, 2, 3, 4, 8, 9</p>
July 2018	L	<p>■Added or modified parts TERMS, Chapter 4, 5, Section 8.1, Chapter 14, Section 18.2, 24.2, 26.1, 26.2, 26.3, 26.6, 28.2, 28.9, Appendix 1, 3, 4, 9</p>
November 2018	M	<p>■Added or modified parts RELEVANT MANUALS, TERMS, Section 3.1, 3.3, Chapter 4, 5, Section 12.1, 12.2, 12.3, Chapter 13, 19, Section 23.2, 24.2, Appendix 1, 2, 3, 4, 5, 9</p>
October 2019	N	<p>■Added modules FX5UJ-24MR/ES, FX5UJ-24MT/ES, FX5UJ-24MT/ESS, FX5UJ-40MR/ES, FX5UJ-40MT/ES, FX5UJ-40MT/ESS, FX5UJ-60MR/ES, FX5UJ-60MT/ES, FX5UJ-60MT/ESS, FX5UC-32MT/DS-TS, FX5UC-32MT/DSS-TS, FX5UC-32MR/DS-TS</p> <p>■Added or modified parts RELEVANT MANUALS, TERMS, Section 1.1, 1.4, 1.5, 3.1, 3.2, 3.3, Chapter 4, 5, Section 6.1, 7.1, 7.2, Chapter 9, Section 10.8, Chapter 11, Section 12.3, Chapter 13, 14, 15, Section 16.1, 17.2, 17.3, 18.2, Chapter 19, Section 20.1, 20.2, 20.13, 21.4, 21.7, 21.9, 23.1, 23.2, Chapter 24, 25, 26, Section 27.2, 28.2, 28.5, 28.9, Appendix 1, 2, 3, 7, 9, TRADEMARKS</p>

Revision date	Revision	Description
May 2020	P	<ul style="list-style-type: none"> <li>■Added functions Data logging function (CSV file output format)</li> <li>■Added or modified parts RELEVANT MANUALS, TERMS, Section 3.2, Chapter 4, Section 10.2, Chapter 13, 20, Section 24.1, 24.2, 26.6, Appendix 1, 2, 3, 4, 6, 7, 9, TRADEMARKS</li> </ul>
August 2020	Q	<ul style="list-style-type: none"> <li>■Added or modified parts SAFETY PRECAUTIONS, WARRANTY</li> </ul>
October 2020	R	<ul style="list-style-type: none"> <li>■Added or modified parts RELEVANT MANUALS, Section 1.4, 1.5, Chapter 2, Section 3.2, Chapter 4, 5, Section 8.1, Chapter 21, Section 23.1, Chapter 24, Section 26.1, 26.2, 28.1, 28.2, 28.10, 28.11, Appendix 1, 2, 3, 4, 5, 6, 9</li> </ul>
January 2021	S	<ul style="list-style-type: none"> <li>■Added or modified parts Section 3.1, Chapter 5, Section 21.4, 28.5, 28.12, Appendix 9</li> </ul>
April 2021	T	<ul style="list-style-type: none"> <li>■Added functions Firmware update function using engineering tool</li> <li>■Added or modified parts RELEVANT MANUALS, TERMS, Section 3.2, Chapter 5, 20, Section 28.13, Appendix 1, 2, 3, 7, 9</li> </ul>
October 2021	U	<ul style="list-style-type: none"> <li>■Added or modified parts RELEVANT MANUALS, TERMS, GENERIC TERMS AND ABBREVIATIONS, Section 5.1, 5.2, 10.8, Appendix 2</li> </ul>
April 2022	V	<ul style="list-style-type: none"> <li>■Added modules FX5S-30MR/ES, FX5S-40MR/ES, FX5S-60MR/ES, FX5S-80MR/ES, FX5S-30MT/ES, FX5S-40MT/ES, FX5S-60MT/ES, FX5S-80MT/ES, FX5S-30MT/ESS, FX5S-40MT/ESS, FX5S-60MT/ESS, FX5S-80MT/ESS</li> <li>■Added functions Scan time clear function</li> <li>■Added or modified parts INTRODUCTION, RELEVANT MANUALS, GENERIC TERMS AND ABBREVIATIONS, Section 1.1, 1.4, 3.1, 3.2, Chapter 4, 5, Section 6.1, 11.1, 13.2, 13.3, 13.4, Chapter 15, Section 17.2, 17.3, Chapter 18, 19, 20, 21, Section 23.1, 23.2, Chapter 24, 26, Section 28.1, 28.2, 28.4, 28.5, 28.10, 28.11, Appendix 1, 2, 3, 4, 6, 7, 9</li> </ul>
October 2022	W	<ul style="list-style-type: none"> <li>■Added functions Heating-cooling PID control function</li> <li>■Added or modified parts GENERIC TERMS AND ABBREVIATIONS, Chapter 4, Section 5.2, Chapter 11, 21, Section 29.2, Appendix 1, 2, 3, 4, 5, 9</li> </ul>
April 2023	X	<ul style="list-style-type: none"> <li>■Added function Input interrupt delay function</li> <li>■Added or modified parts Overall revision according to the manual composition change</li> </ul>
July 2023	Y	<ul style="list-style-type: none"> <li>■Added modules FX5UJ-24MR/DS, FX5UJ-24MT/DS, FX5UJ-24MT/DSS, FX5UJ-40MR/DS, FX5UJ-40MT/DS, FX5UJ-40MT/DSS, FX5UJ-60MR/DS, FX5UJ-60MT/DS, FX5UJ-60MT/DSS</li> <li>■Added or modified parts INTRODUCTION, GENERIC TERMS AND ABBREVIATIONS, Chapter 8, Section 9.1, 9.2, 14.1, 14.2, 14.3, Chapter 18, Appendix 3, 11</li> </ul>
October 2023	Z	<ul style="list-style-type: none"> <li>■Added functions External input/output forced on/off function, data logging file transfer function</li> <li>■Added or modified parts Overall revision according to the manual composition change RELEVANT MANUALS, Chapter 8, Section 10.1, Chapter 17, Section 20.5, 20.6, Chapter 37, Appendix 1, 2, 3, 4, 8, 9, 11</li> </ul>
December 2023	AA	<ul style="list-style-type: none"> <li>■Added or modified parts Section 37.6, 37.8</li> </ul>

Japanese manual number: JY997D54301Y

This manual confers no industrial property rights or any rights of any other kind, nor does it confer any patent licenses. Mitsubishi Electric Corporation cannot be held responsible for any problems involving industrial property rights which may occur as a result of using the contents noted in this manual.

© 2014 MITSUBISHI ELECTRIC CORPORATION

# WARRANTY

Please confirm the following product warranty details before using this product.

## 1. Gratis Warranty Term and Gratis Warranty Range

If any faults or defects (hereinafter "Failure") found to be the responsibility of Mitsubishi occurs during use of the product within the gratis warranty term, the product shall be repaired at no cost via the sales representative or Mitsubishi Service Company. However, if repairs are required onsite at domestic or overseas location, expenses to send an engineer will be solely at the customer's discretion. Mitsubishi shall not be held responsible for any re-commissioning, maintenance, or testing on-site that involves replacement of the failed module.

### [Gratis Warranty Term]

The gratis warranty term of the product shall be for one year after the date of purchase or delivery to a designated place. Note that after manufacture and shipment from Mitsubishi, the maximum distribution period shall be six (6) months, and the longest gratis warranty term after manufacturing shall be eighteen (18) months. The gratis warranty term of repair parts shall not exceed the gratis warranty term before repairs.

### [Gratis Warranty Range]

- (1) The range shall be limited to normal use within the usage state, usage methods and usage environment, etc., which follow the conditions and precautions, etc., given in the instruction manual, user's manual and caution labels on the product.
- (2) Even within the gratis warranty term, repairs shall be charged for in the following cases.
  1. Failure occurring from inappropriate storage or handling, carelessness or negligence by the user. Failure caused by the user's hardware or software design.
  2. Failure caused by unapproved modifications, etc., to the product by the user.
  3. When the Mitsubishi product is assembled into a user's device, Failure that could have been avoided if functions or structures, judged as necessary in the legal safety measures the user's device is subject to or as necessary by industry standards, had been provided.
  4. Failure that could have been avoided if consumable parts (battery, backlight, fuse, etc.) designated in the instruction manual had been correctly serviced or replaced.
  5. Relay failure or output contact failure caused by usage beyond the specified life of contact (cycles).
  6. Failure caused by external irresistible forces such as fires or abnormal voltages, and failure caused by force majeure such as earthquakes, lightning, wind and water damage.
  7. Failure caused by reasons unpredictable by scientific technology standards at time of shipment from Mitsubishi.
  8. Any other failure found not to be the responsibility of Mitsubishi or that admitted not to be so by the user.

## 2. Onerous repair term after discontinuation of production

- (1) Mitsubishi shall accept onerous product repairs for seven (7) years after production of the product is discontinued.  
Discontinuation of production shall be notified with Mitsubishi Technical Bulletins, etc.
- (2) Product supply (including repair parts) is not available after production is discontinued.

## 3. Overseas service

Overseas, repairs shall be accepted by Mitsubishi's local overseas FA Center. Note that the repair conditions at each FA Center may differ.

## 4. Exclusion of loss in opportunity and secondary loss from warranty liability

Regardless of the gratis warranty term, Mitsubishi shall not be liable for compensation to:

- (1) Damages caused by any cause found not to be the responsibility of Mitsubishi.
- (2) Loss in opportunity, lost profits incurred to the user by Failures of Mitsubishi products.
- (3) Special damages and secondary damages whether foreseeable or not, compensation for accidents, and compensation for damages to products other than Mitsubishi products.
- (4) Replacement by the user, maintenance of on-site equipment, start-up test run and other tasks.

## 5. Changes in product specifications

The specifications given in the catalogs, manuals or technical documents are subject to change without prior notice.

## 6. Product application

- (1) In using the Mitsubishi MELSEC programmable controller, the usage conditions shall be that the application will not lead to a major accident even if any problem or fault should occur in the programmable controller device, and that backup and fail-safe functions are systematically provided outside of the device for any problem or fault.
- (2) The Mitsubishi programmable controller has been designed and manufactured for applications in general industries, etc. Thus, applications in which the public could be affected such as in nuclear power plants and other power plants operated by respective power companies, and applications in which a special quality assurance system is required, such as for railway companies or public service purposes shall be excluded from the programmable controller applications.  
In addition, applications in which human life or property that could be greatly affected, such as in aircraft, medical applications, incineration and fuel devices, manned transportation, equipment for recreation and amusement, and safety devices, shall also be excluded from the programmable controller range of applications. However, in certain cases, some applications may be possible, providing the user consults their local Mitsubishi representative outlining the special requirements of the project, and providing that all parties concerned agree to the special circumstances, solely at the user's discretion.
- (3) Mitsubishi shall have no responsibility or liability for any problems involving programmable controller trouble and system trouble caused by DoS attacks, unauthorized access, computer viruses, and other cyberattacks.

# TRADEMARKS

---

Microsoft, Excel, Windows, Windows Vista, and Windows XP are trademarks of the Microsoft group of companies.

PROFIBUS is a trademark of PROFIBUS Nutzerorganisation e.V.

Anywire and AnyWireASLINK are either registered trademarks or trademarks of Anywire Corporation.

Unicode is either a registered trademark or a trademark of Unicode, Inc. in the United States and other countries.

The company names, system names and product names mentioned in this manual are either registered trademarks or trademarks of their respective companies.

In some cases, trademark symbols such as <sup>™</sup> or <sup>®</sup> are not specified in this manual.



Manual number: JY997D55401AA

MODEL: FX5-U-OU-E

MODEL CODE: 09R537

## **MITSUBISHI ELECTRIC CORPORATION**

HEAD OFFICE: TOKYO BLDG., 2-7-3, MARUNOUCHI, CHIYODA-KU, TOKYO 100-8310, JAPAN  
NAGOYA WORKS: 1-14, YADA-MINAMI 5-CHOME, HIGASHI-KU, NAGOYA 461-8670, JAPAN

When exported from Japan, this manual does not require application to the  
Ministry of Economy, Trade and Industry for service transaction permission.

Specifications subject to change without notice.