

FACTORY AUTOMATION

Safety Programmable Controller/Safety Controller





Automating the World



Our Factory Automation business is focused on "Automating the World" to make it a better, more sustainable environment supporting manufacturing and society, celebrating diversity and contributing towards an active and fulfilling role.

Mitsubishi Electric is involved in many areas including the following:

Energy and Electric Systems

A wide range of power and electrical products from generators to large-scale displays.

Electronic Devices

A wide portfolio of cutting-edge semiconductor devices for systems and products.

Home Appliance

Dependable consumer products like air conditioners and home entertainment systems.

Information and Communication Systems

Commercial and consumer-centric equipment, products and systems.

Industrial Automation Systems

Maximizing productivity and efficiency with cutting-edge automation technology.



The Mitsubishi Electric Group is actively solving social issues, such as decarbonization and labor shortages, by providing production sites with energy-saving equipment and solutions that utilize automation systems, thereby helping towards a sustainable society.

Maximizing productivity and reducing total cost while adding value across the manufacturing enterprise

e-F@ctory is the Mitsubishi Electric solution for adding value across the manufacturing enterprise by enhancing productivity, and reducing the maintenance and operations costs together with seamless information flow throughout the plant. e-F@ctory uses a combination of factory automation and IT technologies in combination with various best-in-class partner products through its alliance program, offering solutions to reduce total cost while improving operations, production yield, and efficient management of the supply chain.



FA integrated solution reducing total cost

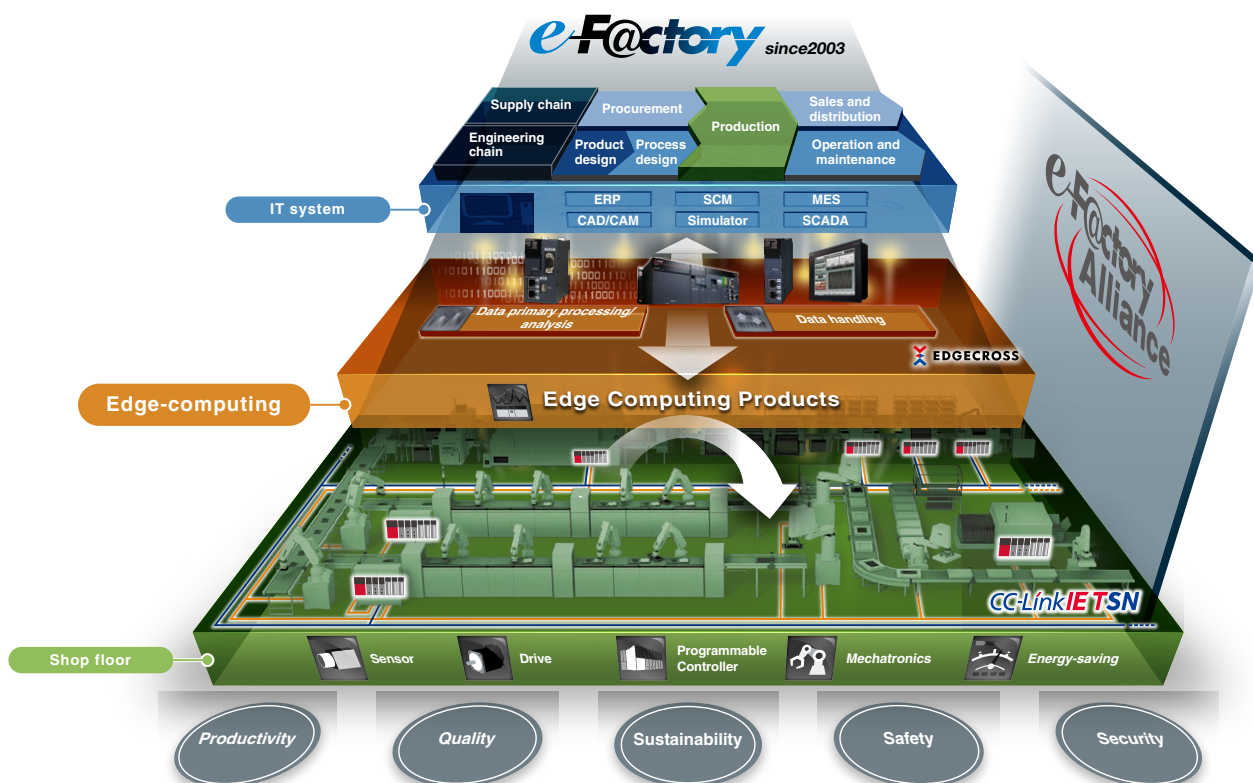

INDEX

Safety standards.....	4	Safety Remote Modules.....	14	Safety Extension Modules	
MELSEC Selection Guide.....	6	Drives	18	MELSEC iQ-F Series	28
MELSEC iQ-R Series		Total Safety Solutions	20	Safety Components partner products.....	32
iQ Platform-compatible PAC	8	Safety Controllers		Support	37
CC-Link IETSN.....	12	MELSEC-WS Series	22	General Specifications.....	41
				Product Lists	42

International safety standards

International standards for machinery safety are hierarchically classified into the following types:

- Type A standards (basic safety standards): ISO 12100
- Type B standards (group safety standards): ISO 13849-1, IEC 61508, etc.
- Type C standards: Individual product standards

ISO 12100 Risk assessment

“Risk assessment” refers to identifying potential hazards present in machinery and evaluating the degree of hazard (risk).

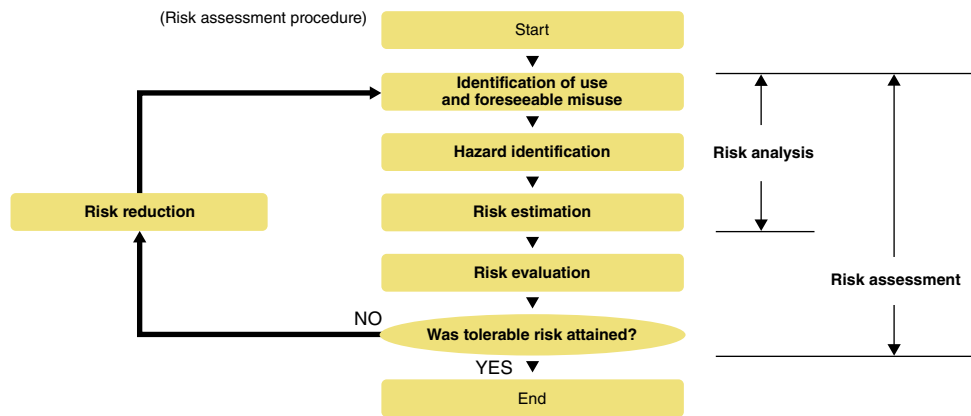

ISO 12100 Risk reduction and safety measures

Under the International Safety Standards, protective measures are implemented to reduce risks to the degree that risks can be tolerated.

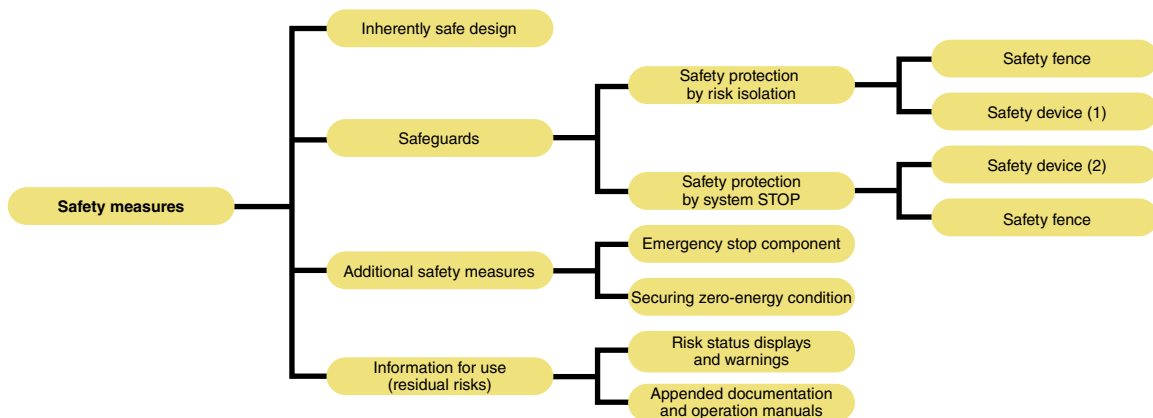

EN ISO 13849-1 Performance level

Frequency of a dangerous failure occurrence (the safety function does not work when needed), rate of a failure detection by diagnostics, etc. were added to evaluate comprehensively. The evaluation result is classified into five levels from “a” to “e” by the performance level (PL).

- The categories and the safety integrity level (SIL) described in the functional safety standard IEC 61508 can be referred to each other via the PL
- Like the safety categories, the risk is evaluated from a perspective of “S: Severity of injury”, “F: Frequency or duration of exposure to risk”, and “P: Possibility of avoidance”

The functional safety standard IEC 61508

With progress of microprocessor technologies, widespread IT, more complex control, etc., demands for configuring safety systems using microprocessors and software have been increased. To meet such demands of the time, the functional safety concept was developed, and the functional safety standard IEC 61508 (electrical/electronic/programmable electronic safety-related systems), which applies to programmable controllers, was issued in 2000.

Risk graph in EN ISO 13849-1 and PLr for safety function

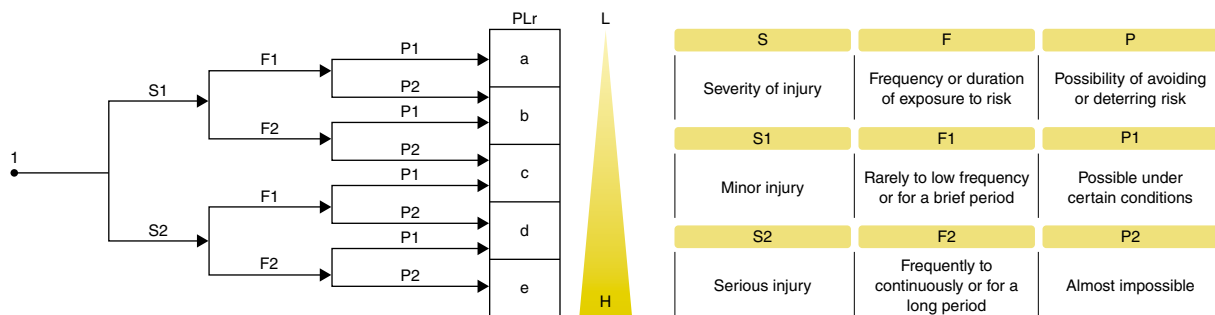

Safety category requirements

Category	Requirement summary	System behavior
B	<ul style="list-style-type: none"> • Shall realize the intended functions of safety-related parts of the machine control system 	<ul style="list-style-type: none"> • The occurrence of a fault can lead to the loss of the safety function
1	<ul style="list-style-type: none"> • Shall meet the requirements of Category B • Shall use well-examined reliable components and observe safety principles 	<ul style="list-style-type: none"> • The same as Category B, but the safety-related part has more reliable safety function
2	<ul style="list-style-type: none"> • Shall meet the requirements of Category B • Shall observe safety principles • Shall check the safety function at appropriate intervals 	<ul style="list-style-type: none"> • Although the loss of the safety function can be detected by checking, the safety function is lost between checks
3	<ul style="list-style-type: none"> • Shall meet the requirements of Category B • Shall observe safety principles • Design requirements: A single fault shall not lead to the loss of the safety function • Detect as many single faults as possible 	<ul style="list-style-type: none"> • The safety function is not lost by a single fault • Some but not all faults can be detected. Accumulation of undetected faults may lead to the loss of the safety function
4	<ul style="list-style-type: none"> • Shall meet the requirements of Category B • Shall observe safety principles • Design requirements: Detect a single fault at or before executing safety function. In cases where this is not possible, the safety function shall not be disabled by accumulated faults 	<ul style="list-style-type: none"> • The safety function is always in effect whenever a fault occurs • Faults will be detected in time to prevent the loss of the safety function

MELSEC Selection Guide

Safety control devices to meet customer's requirements

Selection points

Appropriate devices according to the system scale and scalability are available.

Scalability
↑

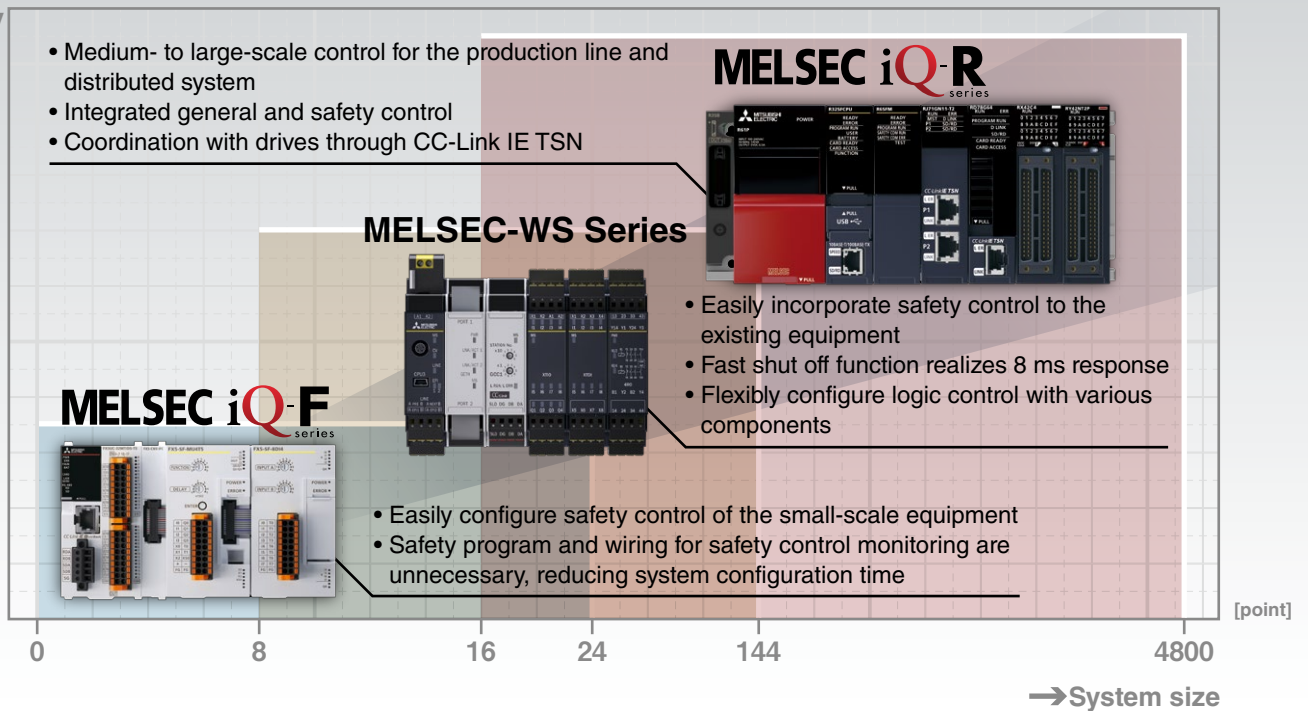

Performance comparison table

The table below shows programming development environment, supported networks, and number of safety I/O points for each Series.

Ⓢ: Safety communication Ⓝ: Non-safety communication

Series	iQ Platform-compatible PAC MELSEC iQ-R Series	Safety controller MELSEC-WS Series	Safety extension module MELSEC iQ-F Series
Programming development environment	GX Works3	Setting and Monitoring Tool	-*1
Program capacity (step)	80K/160K/320K/1200K (40K for safety program)	255 (Function Blocks)	- (9 built-in program)
Network			
CC-Link IE TSN	Ⓢ Ⓝ	-	Ⓝ
CC-Link IE Field Network	Ⓢ Ⓝ	-	Ⓝ
CC-Link IE Controller Network	Ⓝ	-	-
Flexi Line/Link	-	Ⓢ	-
Ethernet	Ⓝ	Ⓝ	Ⓝ
CC-Link	Ⓝ	Ⓝ	Ⓝ
Number of safety I/O points			
System scale (point)	4800	144	24
Max. number of connectable safety I/O modules per system	120 stations	12 modules	3 modules*2
Max. number of input points per system (single wiring) (point)	3840	96	20
Max. number of output points per system (single wiring) (point)	960	48	4

*1. Stored program can be selected by setting the rotary switch, requiring no programming.

*2. One safety main module and two safety input extension modules can be connected.

Remote devices lineup

Flexible system configuration is realized with block-type remote modules and drives.

 : CC-Link IE TSN

 : CC-Link IE Field Network

Block-type safety remote modules



NZ2GNSS2-16DTE



NZ2GNS12A2-16DTE



NZ2GFSS2-16DTE-S1 NEW

Drives

AC servo MELSERVO



MELSERVO-J5 MELSERVO-J4

Inverter FREQROL



FR-E800 FR-A800*1

Industrial robot MELFA



MELFA-FR*1

System configuration examples

From a small- to large-scale system according to requirements are realized with Mitsubishi Electric safety devices.

CC-Link IE TSN

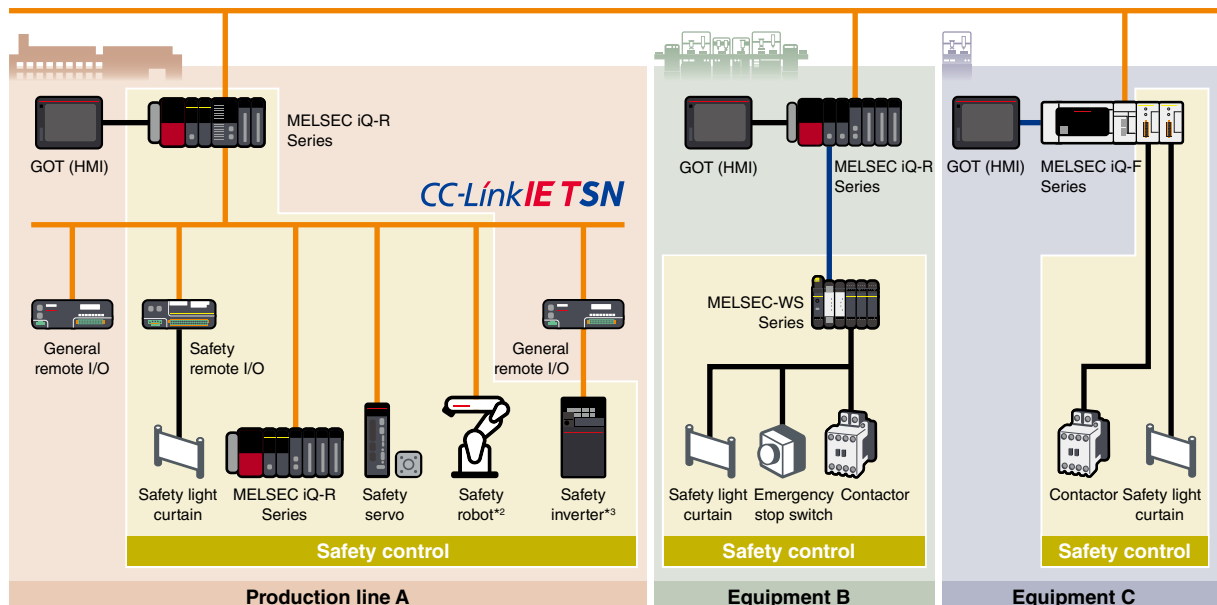

*1. Can be used in combination with a block-type safety remote module (robot safety option is necessary for a robot).

*2. The robot controller CR800-R can be connected via the MELSEC iQ-R Series CC-Link IE TSN master/local module. For detailed information, please refer to page 19.

*3. A device supporting 100 Mbps should be connected following a device supporting 1 Gbps (class B).



MELSEC iQ-R Series

iQ Platform-compatible PAC

The MELSEC iQ-R Series is equipped with a safety CPU module that is compliant with ISO 13849-1 PL e and IEC 61508 SIL 3. The safety CPU module can be installed directly on the MELSEC iQ-R Series base rack and can execute both safety and general programs.

System configuration

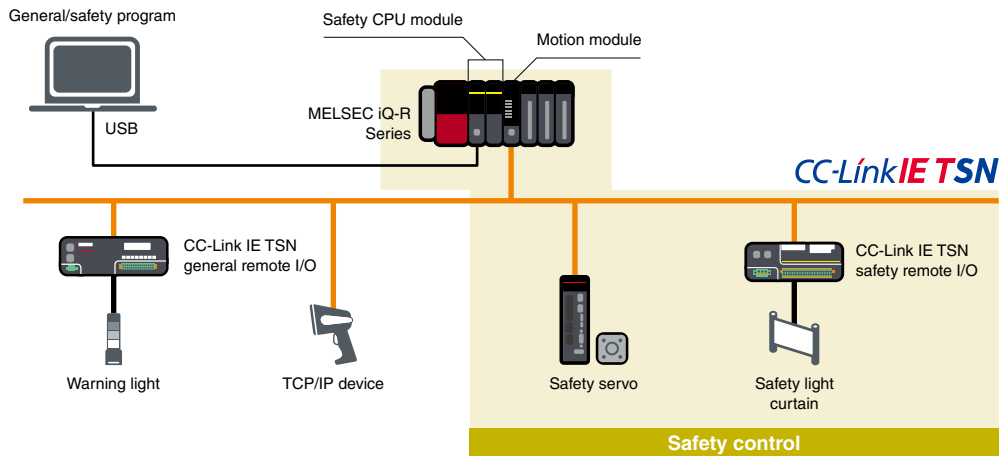

■ CC-Link IE TSN features

- Use general Ethernet cables
- Mix general and safety communications on one network
- Combine with TCP/IP communications

Integrated general and safety control

The MELSEC iQ-R Series safety programmable controller and CC-Link IE TSN can execute both safety and general programs, enabling easy integration into existing or new control systems, reducing costs and saving space.

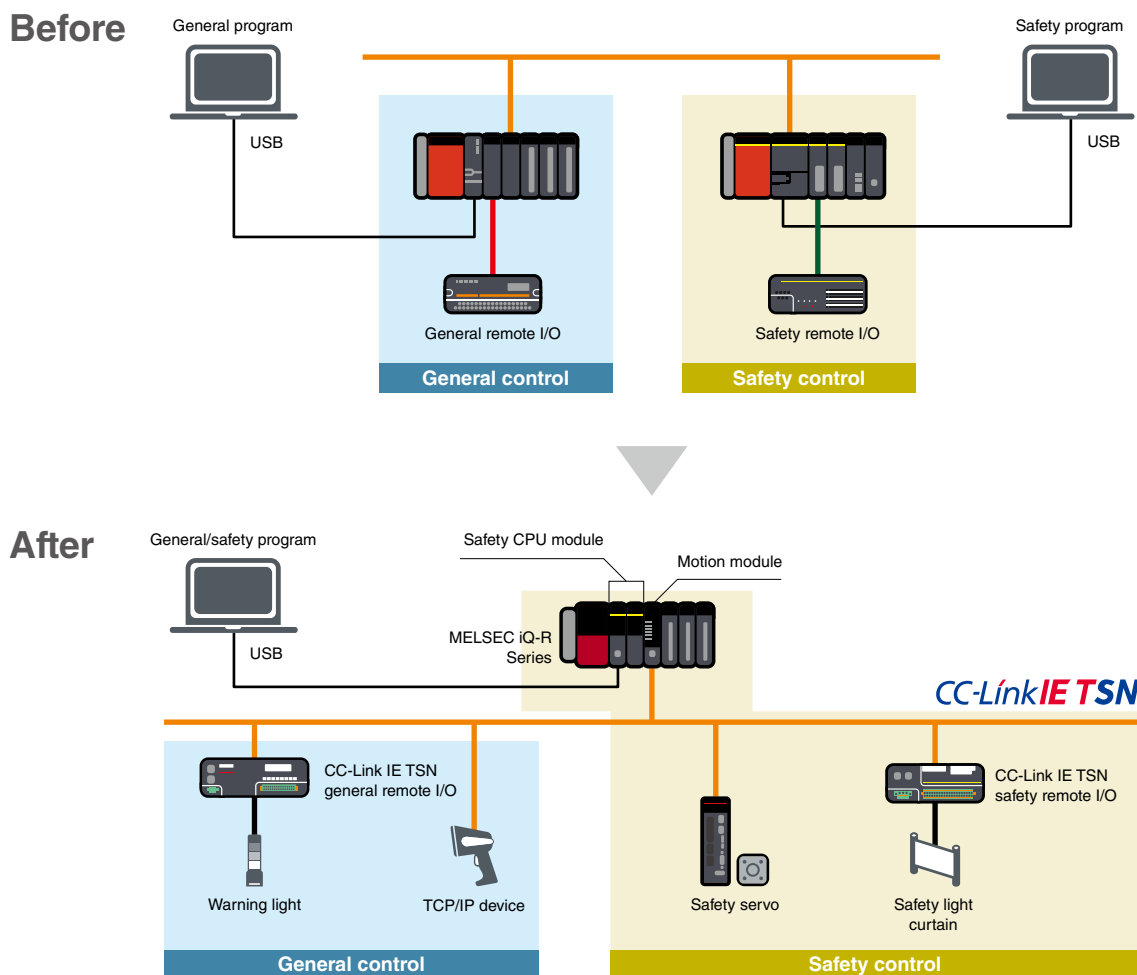

Specifications

Safety CPU module specifications

LD : Ladder diagram ST : Structured text FBD : Function block diagram

Item	R08SFPCPU-SET*1	R16SFPCPU-SET*1	R32SFPCPU-SET*1	R120SFPCPU-SET*1
Category	Category 4 (EN ISO 13849-1)			
Safety integrity level (SIL)	SIL 3 (IEC 61508)			
Performance level (PL)	PL e (EN ISO 13849-1)			
Operation control method	Stored program cyclic operation			
I/O control mode	Refresh mode (Direct access I/O is available by specifying direct access I/O (DX, DY).)			
Programming language	LD ST*2 FBD*2			
Extended programming language	Function block (FB), label programming (local/global)			
Program execution type	Fixed scan, initial*2, scan*2, event execution*2, standby*2			
Number of I/O points (X/Y)	4096	4096	4096	4096
Memory capacity				
Program capacity (step)	80K (40K for safety programs)	160K (40K for safety programs)	320K (40K for safety programs)	1200K (40K for safety programs)
Program memory (byte)	320K	640K	1280K	4800K
Device/label memory*3 (byte)	1178K	1710K	2306K	3370K
Data memory (byte)	5M	10M	20M	40M
SLMP communication	●	●	●	●

*1. Product package includes a safety CPU module (R08SFPCPU) and safety function module (R6SFM).

*2. Cannot be used for safety control programs.

*3. An extended SRAM cassette expands the device/label memory area.

Programmable Automation Controllers

Common engineering platform realizes efficient engineering

■ GX Works3

In the engineering software GX Works3, general and safety programs are included in the same project folder. GX Works3 is highly adaptable to projects in different countries through its multiple language features.

General/safety shared labels

A general/safety shared label is used to pass device data from a safety program to a general program, and vice versa

reset_in

SAISD1240.0

Safety device
Append "SA" to the device name

General control program (non-safety)

- Scan
- MAIN
- ProgPou
- Local Label
- ProgramBody

Safety control program

- Fixed Scan
- MAIN1
- ProgPou1
- Local Label
- ProgramBody

Bi_bActivate	o_bReady:B
Bi_bS_EStopIn	o_bS_EStop_Out:B
Bi_bS_StartReset	o_bError:B
Bi_bS_AutoReset	o_wDiagCode:W
Bi_bReset	

M_SF_ESTOP_R_01A_2 (M_SF_ESTOP_R_01A)
Emergency Stop

Safety FB**
Safety FBs are units of ladder blocks repeatedly used in creating a safety program. Efficient engineering is realized, reducing programming errors

*1. On the actual GX Works3 screen, FB version is shown.

■ Safety FB (Function blocks)

Functions that are frequently used for creating safety programs are provided as certified safety function blocks.

Safety FB list

FB name	Function	Description
M+SF_2HAND2_R	Two hand switch Type II	Provides the two-hand control functionality.
M+SF_2HAND3_R	Two hand switch Type III	Provides the two-hand control functionality. (Fixed specified time difference is 500 ms.)
M+SF_EDM_R	External device monitor	Controls a safety output and monitors controlled actuators, e.g. subsequent contractors.
M+SF_ENBSLW_R	Enable switch	Evaluates the signals of an enable switch with three positions.
M+SF_ESPE_R	Light Curtain (ESPE)	Safety-related FB for monitoring electro-sensitive protective equipment (ESPE).
M+SF_ESTOP_R	Emergency Stop	Safety-related FB for monitoring an emergency stop switch. This FB can be used for emergency switch off functionality (stop category 0).
M+SF_GLOCK_R	Guard Lock and Interlocking	Controls an entrance to a hazardous area via an interlocking guard with guard locking ("four state interlocking").
M+SF_GMON_R	Guard Monitoring	Monitors the relevant safety guard. There are two independent input parameters for two switches at the safety guard coupled with a time difference (Monitoring Time) for closing the guard.
M+SF_MODSEL_R	Mode Selector	Selects the system operation mode, such as manual, automatic, and semi-automatic, etc.
M+SF_OUTC_R	Output Control	Control of a safety output with a signal from the functional application and a safety signal with optional startup inhibits.
M+SF_MUTE2_R	Muting with 2 sensors	Muting is the intended suppression of the safety function. (e.g., light barriers) In this FB, parallel muting with two muting sensors is specified.
M+SF_MUTE2_2_R	Muting with 2 sensors 2	Muting is the intended suppression of the safety function. (e.g., light barriers) In this FB, parallel muting with two muting sensors is specified. The effective time of the muting control can be set to be unlimited.
M+SF_MUTEP_R	Parallel muting	Parallel muting with four muting sensors is specified.
M+SF_MUTEP_2_R	Parallel muting 2	In this FB, parallel muting with four muting sensors is specified. The effective time of the muting control can be set to be unlimited.
M+SF_MUTES_R	Sequential muting	Sequential muting with four muting sensors is specified.
M+SF_MUTES_2_R	Sequential muting 2	In this FB, sequential muting with four muting sensors is specified. The effective time of the muting control can be set to be unlimited.
M+SF_TSEN_R	Testable safety sensor	Detects, for example, the loss of the sensing unit detection capability, the response time exceeding that specified, and static ON signal in signal-channel sensors systems. It can be used for external testable safety sensors.
M+SF_EQUI_R	Double input (NC + NC or NO + NO)	Converts two equivalent bit inputs (both NO or NC) to one bit with discrepancy time monitoring. This FB output shows the result of the evaluation of both channels.
M+SF_ANTI_R	Double input (NO + NC)	Converts two antivalent*2 bit inputs (NO/NC pair) to one bit output with discrepancy time monitoring. This FB output shows the result of the evaluation of both channels.

*2. "Antivalent" means that during normal operation, the two inputs are in opposite states at the same time. This is sometimes called "complementary" or "non-equivalent".

Integrated hardware simulator simplifying debugging

The engineering software GX Works3 features an integrated simulator which helps to visualize the operation of the program during the debugging process.

- Programs can be debugged with a virtual safety programmable controller on the computer
- No need for connecting to the CPU module

Offline debugging without requiring a control CPU

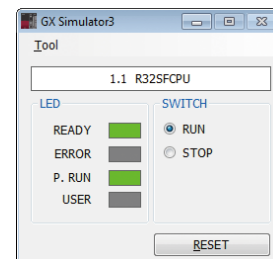
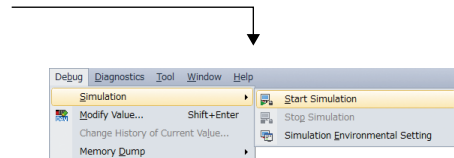
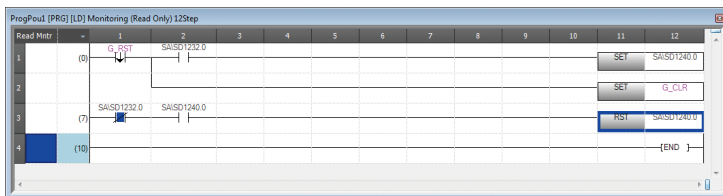

Easier troubleshooting reducing downtime

The MELSEC iQ-R Series includes various maintenance features:

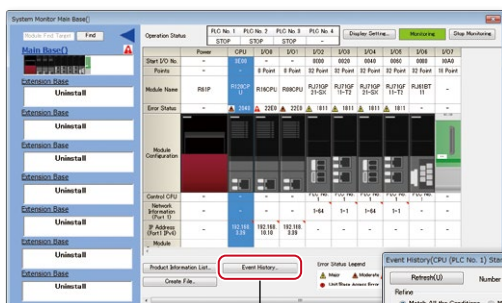

System monitor

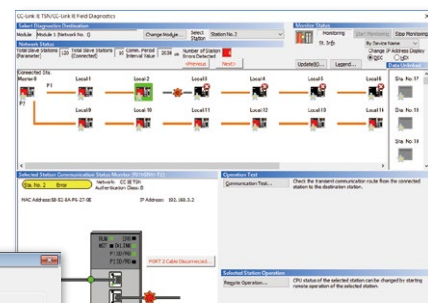

Diagnostics window

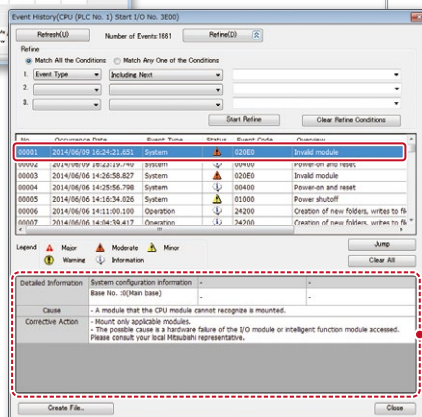

Event history

Detailed information including the cause and respective countermeasures are shown here

Open integrated networking across the manufacturing enterprise

CC-Link IE TSN*1 supports TCP/IP communications and applies it to industrial architectures through its support of TSN enabling real-time communications. With its flexible system architecture and extensive setup and troubleshooting features make CC-Link IE TSN ideal for building an IIoT*2 infrastructure across the manufacturing enterprise.

*1. TSN: Time Sensitive Networking
 *2. IIoT: Industrial Internet of Things

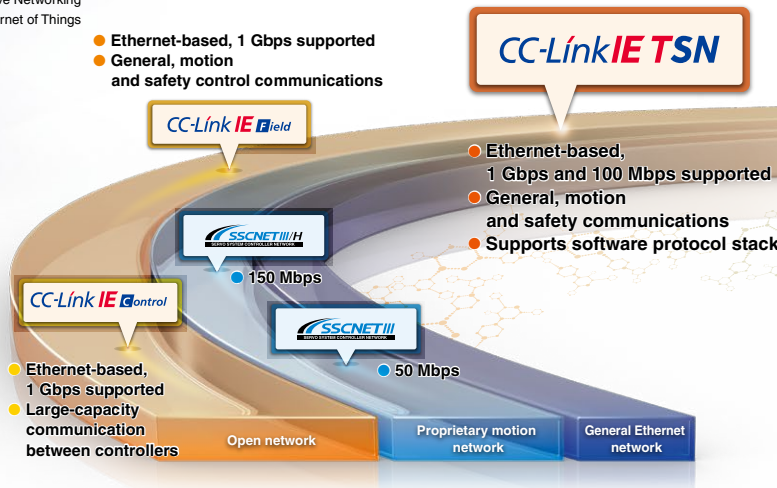

Smart factory integration combining IT systems such as OPC UA with networked devices supporting other communication protocols

Build fully connected factory networks with vertical and horizontal integration across many different layers, automation control zones and network nodes. Realize system optimization on the same network while reducing overall network hardware and software costs.

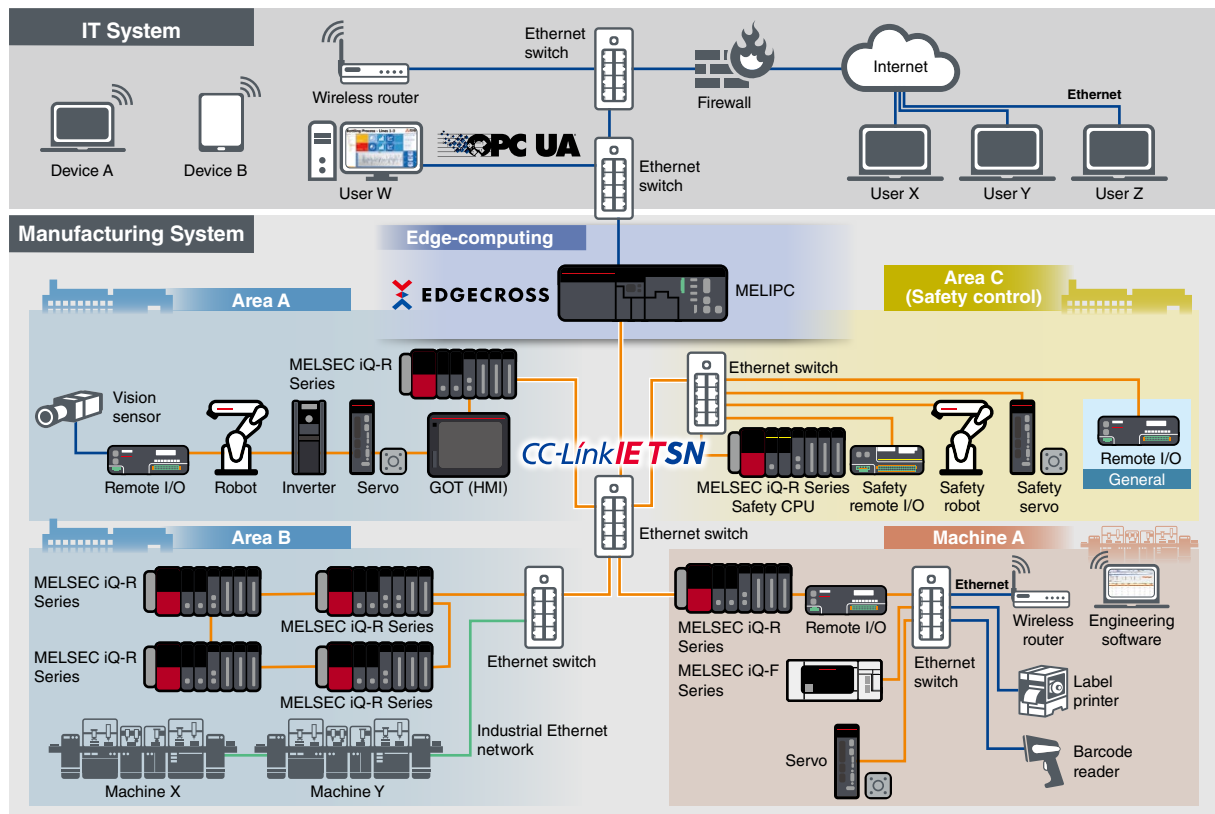

Deterministic control even if mixed with TCP/IP and safety communication

CC-Link IE TSN enables mixing of safety and non-safety communications.*1 Safety monitoring functions (STO, SS1, SS2, SOS, SLS, SBC, SSM) are also supported for safety drives that are on the network. Deterministic performance of cyclic communication is maintained even when mixed with slower information data (non real-time). This enables TCP/IP communication devices to be used without affecting overall control.

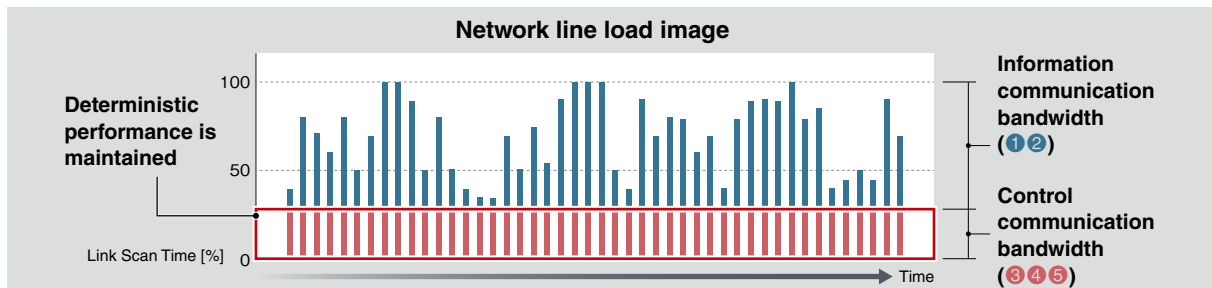
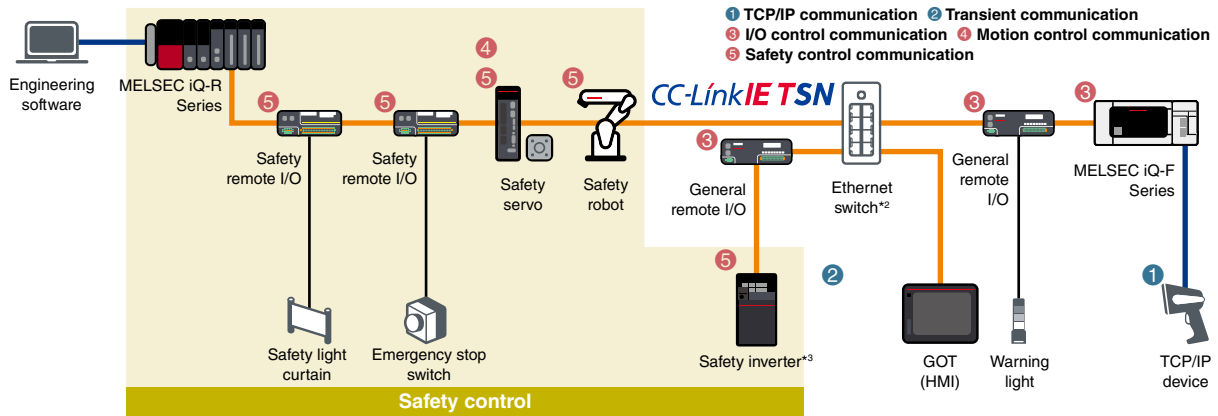

*1. Some devices cannot be connected to CC-Link IE TSN depending on the system configuration.
 *2. Class B managed Ethernet switch supporting CC-Link IE TSN recommended by the CC-Link Partner Association
 *3. A device supporting 100 Mbps should be connected following the device supporting 1 Gbps (class B).

Flexible system configuration with multiple topologies

Line, star, and ring topologies are supported, allowing a flexible system configuration. Use line topology for high-speed, high-performance control. This is realized when a system is configured with CC-Link IE TSN-compatible device stations only without additional branch lines. Choose a star topology if a more flexible system configuration is needed. Using Ethernet switches, device stations can be easily distributed to achieve the desired system configuration. Ring topology is ideal for systems requiring high reliability. Data communications continue with normal stations even if a cable is disconnected or an error occurs on a device station via multi-directional communication.

Line topology

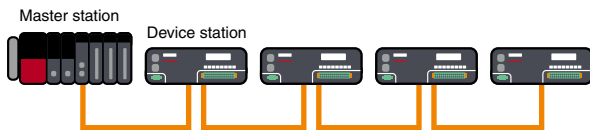

Star topology

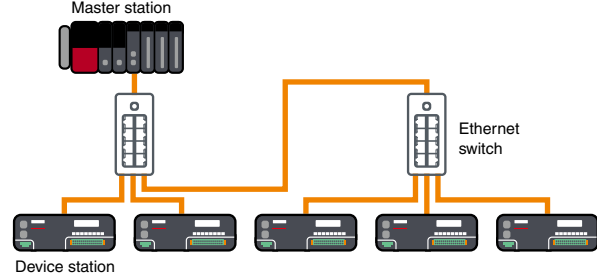

Ring topology

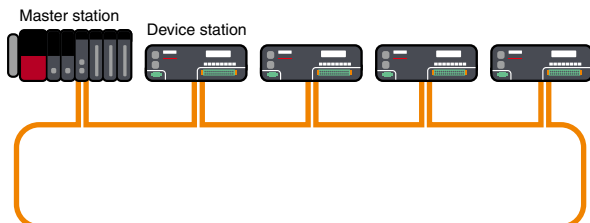

Safety Remote Modules

Block-type remote modules with safety functions

- Block-type remote modules that support safety functions
- Performs safety control when used together with the MELSEC iQ-R Series safety CPU module
- Single or double wiring can be selected per input and output point
- Compliant with international safety standards, ISO 13849-1 Category 4 PL e and IEC 61508 SIL 3 (NZ2GNS12A2-14DT complies with Category 3)
- The waterproof/dustproof type complies with IP67. A control panel is no longer necessary, saving on hardware cost and space

CC-Link IETSU

Input module

Spring-clamp terminal block

NZ2GNSS2-8D

Model	Input type DC input	Input points	Rated input voltage/current	Wiring type
NZ2GNSS2-8D	Negative common	Single wiring: 8 points Double wiring: 4 points	24 V DC (7.3 mA)	2-wire

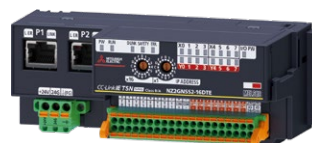

NZ2GNSS2-16DTE



NZ2GNS12A2-16DTE

Output module

Spring-clamp terminal block

NZ2GNSS2-8TE

Model	Output type Transistor output	Output points	Rated load voltage/Max. load current	Wiring type
NZ2GNSS2-8TE	Source + source	Single wiring: 8 points Double wiring: 4 points	24 V DC (0.5 A/point)	2-wire

I/O combined module

Spring-clamp terminal block

NZ2GNSS2-16DTE

Model	Input type DC input	Input points	Rated input voltage/ current	Output type Transistor output	Output points	Rated load voltage/ Max. load current	Wiring type
NZ2GNSS2-16DTE	Negative common	Single wiring: 8 points Double wiring: 4 points	24 V DC (7.3 mA)	Source + source	Single wiring: 8 points Double wiring: 4 points	24 V DC (0.5 A/point)	2-wire

Waterproof/dustproof type (IP67) I/O combined modules

Waterproof connector (screw lock)

NZ2GNS12A2-14DT

NZ2GNS12A2-16DTE

Model	Input type DC input	Input points	Rated input voltage/current	Output type Transistor output	Output points	Rated load voltage/ Max. load current	Wiring type
NZ2GNS12A2-14DT	Negative common	Single wiring: 12 points Double wiring: 6 points	24 V DC (6.8 mA)	Source + sink	Single wiring: not possible Double wiring: 2 points	24 V DC (2 A/point, 4 A/point)*1	2-wire
NZ2GNS12A2-16DTE	Negative common	Single wiring: 12 points Double wiring: 6 points	24 V DC (6.8 mA)	Source + source	Single wiring: 4 points Double wiring: 2 points	24 V DC (2 A/point, 4 A/point)*1	2-wire

*1. Maximum load current specifications may vary depending on the output terminals. For more information, please refer to the relevant product manual.

■ Safety protocol versions and safety communication standards

Safety communication of the CC-Link IE Field Network complies with safety communication standards (IEC61784-3). Please note that said standards of different publication year applies to each safety protocol version.

Safety protocol version	Safety communication standards publication year
1	IEC 61784-3: 2010
2	IEC 61784-3: 2021

Safety protocol versions vary depending on the product types and firmware versions. Please refer to connectability of the master stations and safety remote I/Os below. For how to check firmware versions, please refer to the relevant product manuals.

■ Connectability of the master station and safety remote I/Os

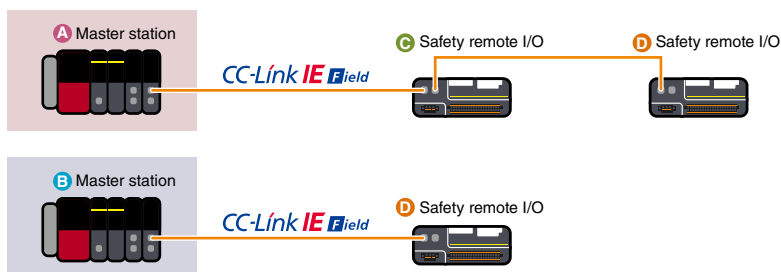

- A Safety protocol versions: 1 and 2** Master station (safety CPU module): firmware version 29 or later
(master module RJ71GF11-T2): firmware version 70 or later
- B Safety protocol version: 1** Master station (safety CPU module): firmware versions 01 to 28
(master module RJ71GF11-T2): firmware versions 06 to 69
- C Safety protocol version: 2** Safety remote I/O: Model name ends with “-S1”
- D Safety protocol version: 1** Safety remote I/O: Model name does not end with “-S1”

●: System configuration is possible; ○: possible with constraints*1; -: not possible

Connected device (master station)	Safety remote I/O		
	C	C + D	D
Firmware version of connected device			
A	●	○*1	○*1
B	-	-	○*1

*1. Although a system can be configured, it is not possible to newly acquire a certification from a third-party certification body. As compliance with the latest standard is required to acquire a certification, it is recommended that only products that support safety protocol version 2 be used when acquiring a certification.

Safety Remote Modules

C Safety protocol version: 2

Input modules

Spring-clamp terminal block

NZ2GFSS2-8D-S1 **NEW**

NZ2GFSS2-32D-S1 **NEW**



NZ2GFSS2-16DTE-S1

Model	Input type DC input	Input points	Rated input voltage/current	Wiring type	Extension module connectability	Connectable device	
						A	B
NZ2GFSS2-8D-S1	Negative common	Single wiring: 8 points Double wiring: 4 points	24 V DC (7 mA)	2-wire	●	●	-
NZ2GFSS2-32D-S1	Negative common	Single wiring: 32 points Double wiring: 16 points	24 V DC (6 mA)	2-wire	●	●	-

C Safety protocol version: 2

Output module

Spring-clamp terminal block

NZ2GFSS2-8TE-S1 **NEW**

Model	Output type Transistor output	Output points	Rated load voltage/ Max. load current	Wiring type	Extension module connectability	Connectable device	
						A	B
NZ2GFSS2-8TE-S1	Source + source	Single wiring: 8 points Double wiring: 4 points	24 V DC (0.5 A)	2-wire	●	●	-

C Safety protocol version: 2

I/O combined module

Spring-clamp terminal block

NZ2GFSS2-16DTE-S1 **NEW**

Model	Input type DC input	Input points	Rated input voltage/ current	Output type Transistor output	Output points	Rated load voltage/ Max. load current	Wiring type	Extension module connectability	Connectable device	
									A	B
NZ2GFSS2-16DTE-S1	Negative common	Single wiring: 8 points Double wiring: 4 points	24 V DC (7 mA)	Source + source	Single wiring: 8 points Double wiring: 4 points	24 V DC (0.5 A)	2-wire	●	●	-

For details on **A**, **B**, **C**, and **D**, please refer to page 15.

Extension output module

Spring-clamp terminal block

NZ2EXSS2-8TE

Model	Output type Transistor output	Output points	Rated load voltage/ Max. load current	Wiring type
NZ2EXSS2-8TE*1	Source + source	Single wiring: 8 points Double wiring: 4 points	24 V DC (0.5 A/point)	2-wire

*1. This product is connectable with safety input modules (NZ2GFSS2-32D, NZ2GFSS2-32D-S1).

When using **B** for the master station, please select the following products.

D Safety protocol version: 1

Input modules

Spring-clamp terminal block

NZ2GFSS2-8D NZ2GFSS2-32D



NZ2GFSS2-16DTE

Model	Input type DC input	Input points	Rated input voltage/current	Wiring type	Extension module connectability	Connectable device	
						A	B
NZ2GFSS2-8D	Negative common	Single wiring: 8 points Double wiring: 4 points	24 V DC (7 mA)	2-wire	●	●	●
NZ2GFSS2-32D	Negative common	Single wiring: 32 points Double wiring: 16 points	24 V DC (6 mA)	2-wire	●	●	●

D Safety protocol version: 1

Output module

Spring-clamp terminal block

NZ2GFSS2-8TE

Model	Output type Transistor output	Output points	Rated load voltage/ Max. load current	Wiring type	Extension module connectability	Connectable device	
						A	B
NZ2GFSS2-8TE	Source + source	Single wiring: 8 points Double wiring: 4 points	24 V DC (0.5 A/point)	2-wire	●	●	●

D Safety protocol version: 1

I/O combined module

Spring-clamp terminal block

NZ2GFSS2-16DTE

Model	Input type DC input	Input points	Rated input voltage/current	Output type Transistor output	Output points	Rated load voltage/ Max. load current	Wiring type	Extension module connectability	Connectable device	
									A	B
NZ2GFSS2-16DTE	Negative common	Single wiring: 8 points Double wiring: 4 points	24 V DC (7 mA)	Source + source	Single wiring: 8 points Double wiring: 4 points	24 V DC (0.5 A/point)	2-wire	●	●	●

For details on **A**, **B**, **C**, and **D**, please refer to page 15.

Higher level of safety in coordination with AC servo MELSERVO-J5 Series

MR-J5-G-RJ/MR-J5D-G4 support CC-Link IE TSN safety communication function as standard. Safety sub-functions are used by combining the safety CPU module (R□SFCPU-SET) with the motion module (RD78G/RD78GH). Safety sub-functions of the servo amplifier can be controlled using safety signals of the safety remote I/O connected with CC-Link IE TSN without connecting with the servo amplifier, realizing the safety system with less wiring.

■ AC servo MELSERVO-J5 Series

- CC-Link IE TSN (1 Gbps) and safety control part are embedded as standard
- Further improve the safety level by combining with the servo motor HK-_WS supporting functional safety
- Provide safety sub-functions complying with IEC/EN 61800-5-2 as SIL 2 or SIL 3 compliant safety level



■ System configuration

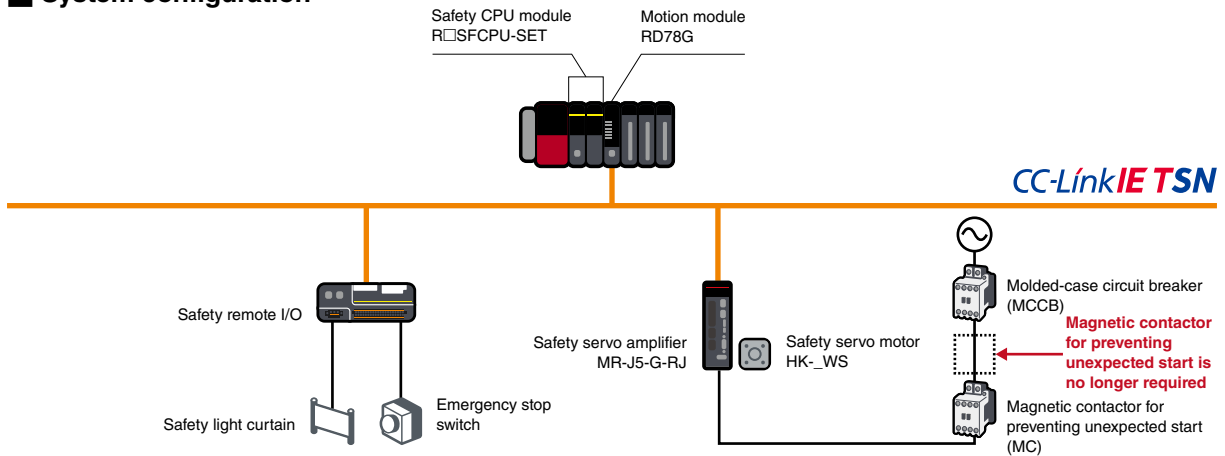

■ Support STO function of IEC/EN 61800-5-2 as standard

- Safe Torque Off (STO) is the function categorized as stop category 0 of IEC 60204-1 that corresponds to an immediate removal of power to a motor
- In addition to rotary servo motors, direct drive motors and linear servo motors are available with safety sub-functions

Safety level combinations**

Servo amplifier		MR-J5-G-RJ/MR-J5D-G4			
Servo motor		Functional safety supported (HK-_WS)		Rotary servo motor (HK Series) Linear servo motor (LM Series) Direct drive motor (TM Series)	
Functional safety category (ISO 13849-1, IEC 62061)		Cat. 4, PL e, SIL 3	Cat. 3, PL d, SIL 2	Cat. 4, PL e, SIL 3	Cat. 3, PL d, SIL 2
STO	Safe Torque Off	●	-	●	-
SS1-t	Safe Stop 1, time controlled	●	-	●	-
SS1-r*2	Safe Stop 1, ramp monitored	●	-	-	●
SS2-t*2	Safe Stop 2, time controlled	●	-	-	-
SS2-r*2	Safe Stop 2, ramp monitored	●	-	-	-
SOS*2	Safe Operating Stop	●	-	-	-
SBC	Safe Brake Control	●	-	●	-
SLS*2	Safely-Limited Speed	●	-	-	●
SSM*2	Safe Speed Monitor	●	-	-	●
SDI*2	Safe Direction	●	-	-	●
SLI*2	Safely-Limited Increment	●	-	-	-
SLT	Safely-Limited Torque	-	●	-	●

*1. For detailed information, please refer to the "Mitsubishi Electric AC Servo System MELSERVO-J5 Catalog (L(NA)03179ENG)".

*2. A fully closed loop system does not support SS1-r, SS2, SOS, SLS, SSM, SDI, and SLI.

Coordination with FREQROL-E800 Series inverter and MELFA FR Series industrial robot ensures safety and productivity

The FR-E800-SCE inverter is provided with safety functions as standard. The CR800-R robot controller can use safety devices connected to the safety remote I/O modules. Preparing separate safety communication devices or complex wiring are not required.

■ Inverter FREQROL-E800 Series

- CC-Link IE TSN (100 Mbps) and safety control part are embedded as standard
- Efficient protocol enables real-time collection of shop floor data
- Enables mixing of real-time control communication and TCP/IP communication



■ Industrial robot MELFA FR Series controller CR800-R

- Safety communication and safety programmable controllers realize a system with less wiring and reduced costs
- Flexible system configuration is possible through coordination with the safety programmable controller utilizing safety communication function



■ System configuration

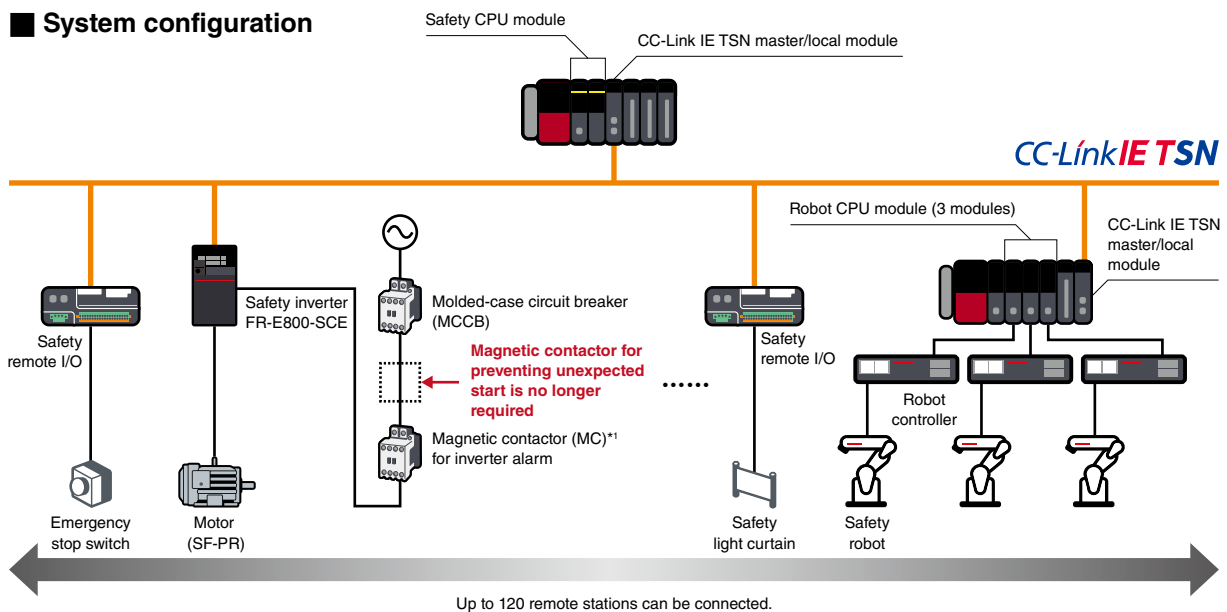

■ Expanded functional safety realizing collaboration of operators and machines

- Compliant with safety sub-functions (IEC/EN 61800-5-2) such as STO (Safe Torque Off) and SLS (Safely-Limited Speed), contributing to operation ensuring operator's safety

		FR-E800-SCE
Functional safety category (ISO 13849-1, IEC 62061)		Cat. 3, PL e, SIL 3
STO	Safe Torque Off	●
SS1	Safe Stop 1, ramp monitored	●
SBC	Safe Brake Control	●
SLS	Safely-Limited Speed	●
SSM	Safe Speed Monitor	●

		CR800-R	
Functional safety category (IEC/EN 61508, EN ISO 13849-1)		Cat. 4, PL e, SIL 3	Cat. 3, PL d, SIL 2
STO	Electrically shuts off power to the motors	●*2	●*2
SS1	After decelerating the motors to stop, the robot goes into the STO state	-	●
SS2	After decelerating the motors to stop, the robot goes into the SOS state	-	●
SOS	Checks that the robot has stopped without shutting off power to the motors	-	●
SLS	Checks that parts of the robot arm do not exceed the speed limit	-	●
SLP	Checks that a predetermined position does not pass through the position monitoring plane	-	●

*1. A magnetic contactor is not required when STO is used. However, in this system configuration, one magnetic contactor is used to shut off the power at alarm occurrence.

*2. Functional safety category can be switched by parameter.

Application example

■ Automotive assembly line

Ensures safety on a large-scale production line and distributed system such as an automotive assembly line with multiple welding robots operating. In systems with multiple stations and safety controllers, critical safety data is shared over the network which allows an emergency stop signal to be sent to the stations before and after within the production line. The safety CPU module is connected using CC-Link IE TSN with safety communication integrated into the network protocol. Also, the motion module supports safety communication with the AC servo via CC-Link IE TSN. General and safety devices, together with drives can be connected on the same network line, realizing a reduced wiring and highly scalable system lowering overall system cost. CC-Link IE TSN master/local modules can connect up to 120 devices.

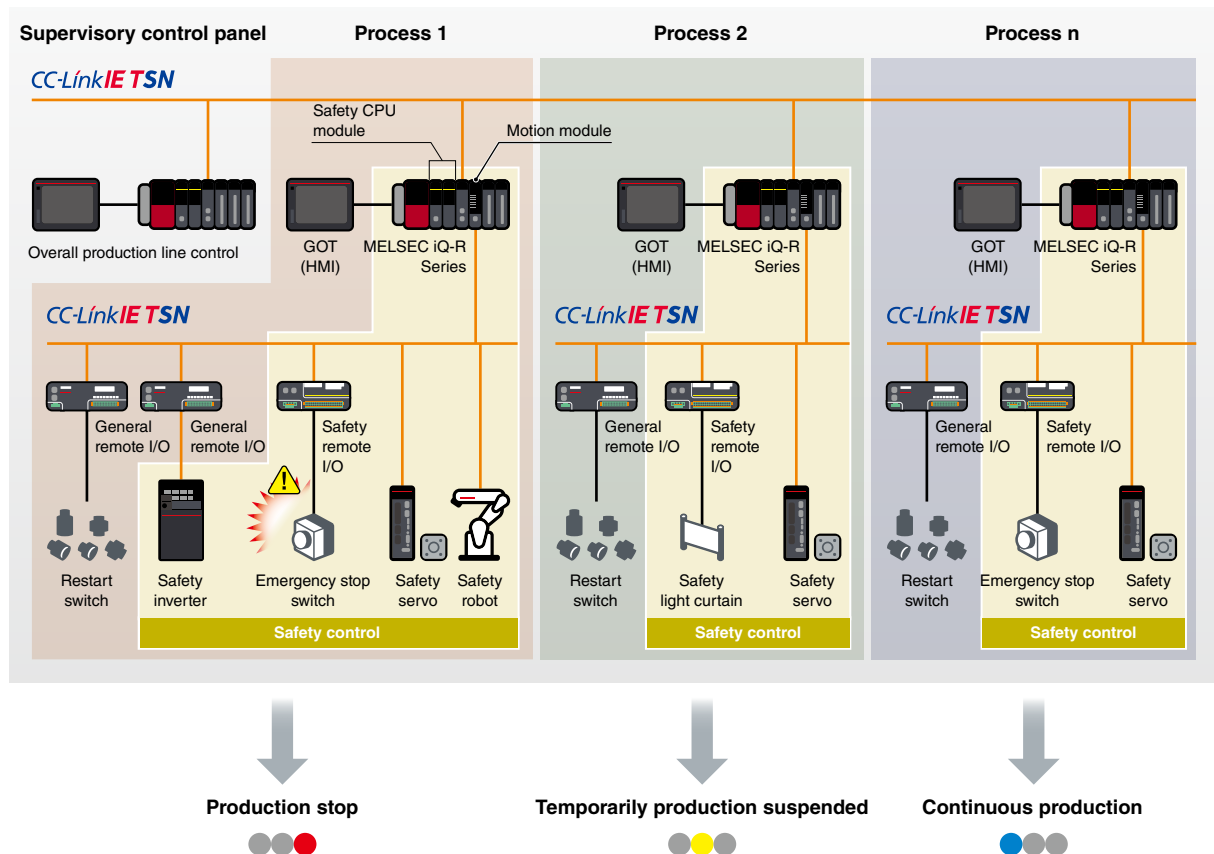
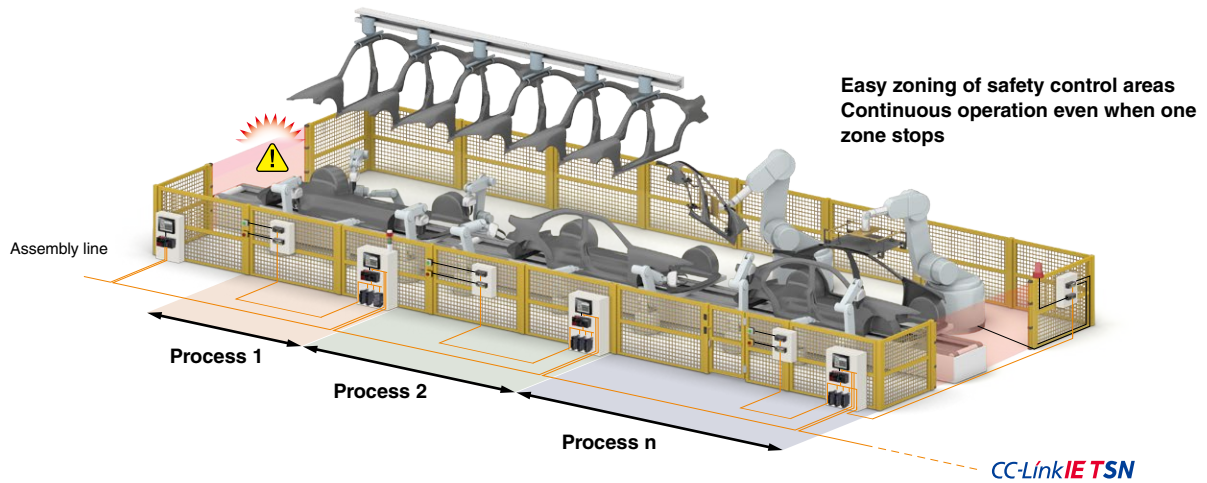

Smooth production restart by utilizing Safe Stop 2 (SS2) and Safe Operating Stop (SOS)

An operator-safe work zone is ensured by providing an exclusion fence around the production robots or stopping the production line when activating the STO (Safe Torque Off) (shuts off power to the servo motors and robots responding to the input signal from a safety light curtain or switch). With MELSERVO-J5 Series and MELFA FR Series, the zone can be ensured by utilizing SS2 and SOS that enable the production line to stop while power to the servo motors and robots is kept supplied, enabling a smooth production restart and ensuring improved productivity without compromising safety.

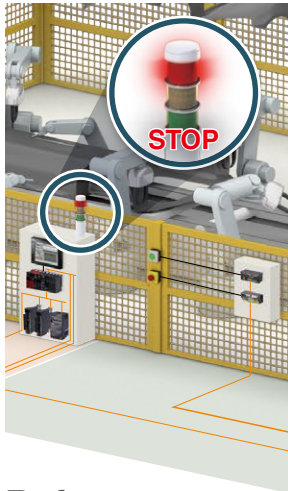

Before

- Production is stopped when STO is activated
- Restart requires more time

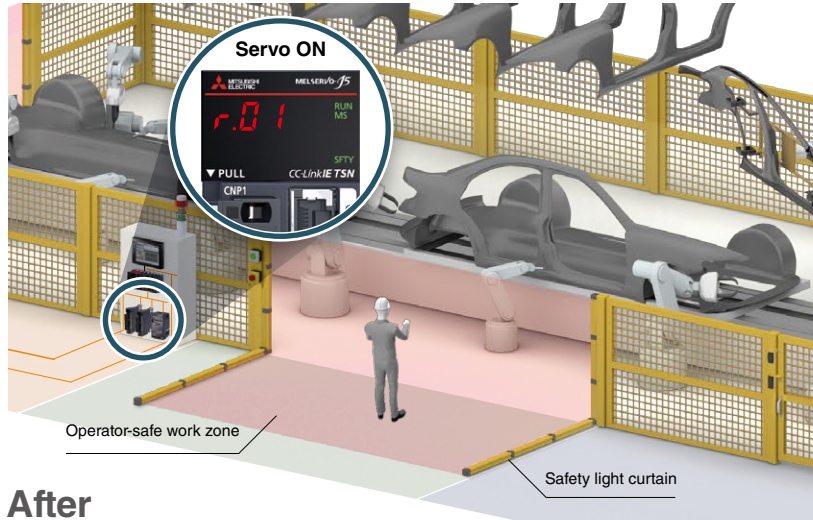

After

- Production is brought to a safe stop (while power to the servo motors and robots is kept supplied)
- Reduction in production restart time

Maintenance while continuously operating machines with Safety-Limited Speed (SLS)

Utilizing the STO (Safe Torque Off), safety of an operator-safe work zone is ensured by enabling the control system to be brought to a safe stop. Safety total solution with the FR-E800-SCE inverter, Safety-Limited Speed (SLS) enables continuous operation with the set frequency without stopping machines when an operator enters the operator-safe work zone.

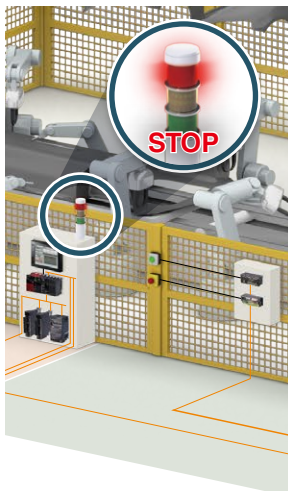

Before

- Production is stopped when STO is activated

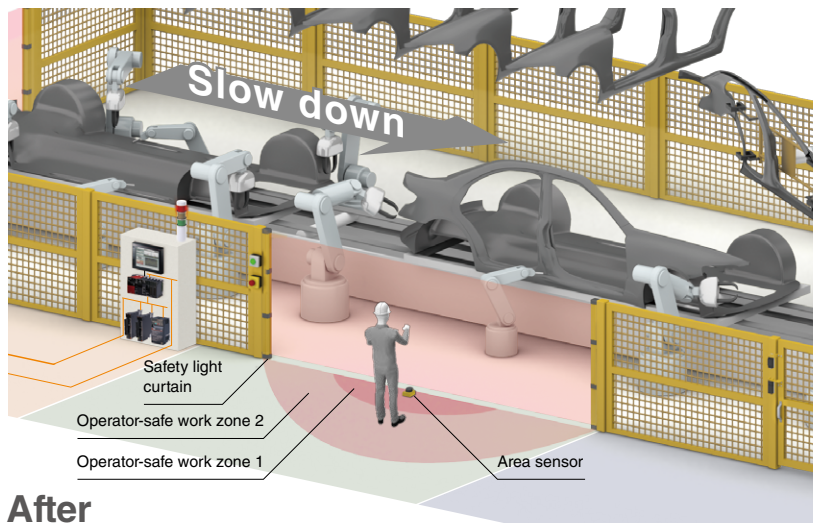

After

- Operation with reduced speed by SLS



Safety Controllers MELSEC-WS Series

Powered by
SICK

The MELSEC-WS Series was developed and manufactured by SICK AG. Sick is a German supplier of safety solutions. For more information, please refer to the relevant product manuals or contact your local Mitsubishi Electric sales office or representative.

This compact safety controller complies with EN ISO 13849-1 Category 4/PL e and IEC 61508 SIL 3 safety standards. It is ideal for small- to medium-scale safety control system. Safety I/O points can be extended to 144 points per CPU module according to the system configuration. Utilizing the dedicated Setting and Monitoring Tool*¹, setup and logic creation can be easily done.

*1. For details on how to obtain the tool, please contact your local Mitsubishi Electric sales office or representative.

System configuration

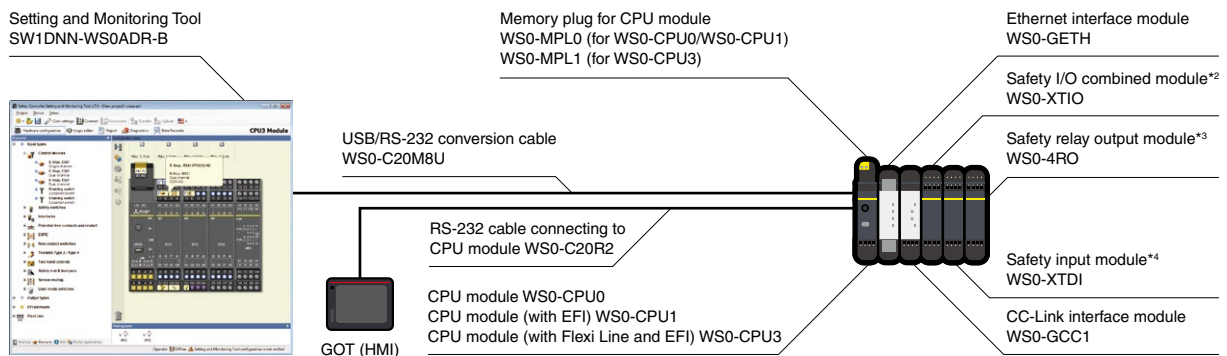

*2. No. of input points: 8 points (single wiring), No. of output points: 4 points (single wiring)

*3. Safety relay output: 4 points

*4. No. of input points: 8 points (single wiring)

Safety control can be easily added to existing programmable controllers (CC-Link/Ethernet)

Connecting the safety controller to CC-Link, safety control can be performed with the existing MELSEC iQ-R/Q/L Series module. Furthermore, operation status and error status of the safety controller can be monitored with the programmable controller. This helps quickly identifying the factor of emergency stop and faulty equipment.

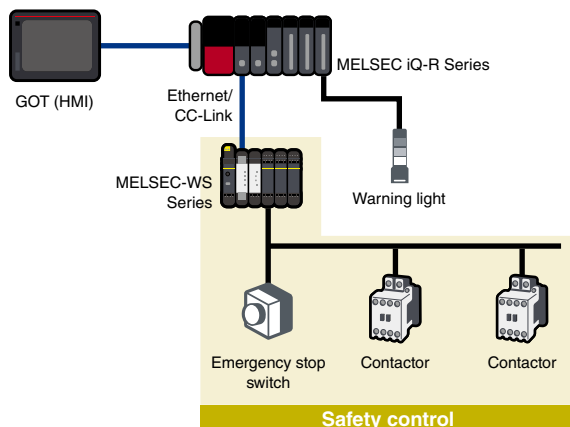

Applicable functions with network interface

	CC-Link (WS0-GCC1)	Ethernet (WS0-GETH)
PLC/PC		
Monitoring information	●	●
Notification data	●	●
Setting and Monitoring tool		
Connection via network	-	●

Flexible extensibility

- Up to 12 safety input and I/O modules, 4 safety relay output modules, and 2 network modules can be installed
- I/O points can be extended to 144 points (single input). Safety input: 96 points (single input) and safety output: 48 points (single output)

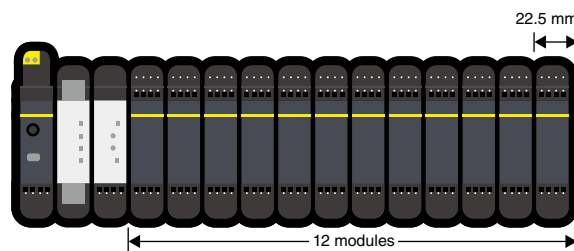

Fast shut off function realizes a response time of 8 ms

The fast shut off function that enables the safety I/O module to shut off safety output without going through the CPU module realizes a response time of 8 ms. Since similar response time is achieved even with increased I/O points, the safety distance can be shortened even in the large-scale safety system.

Fast shut off function is not used

Response time = ① + ② + ③

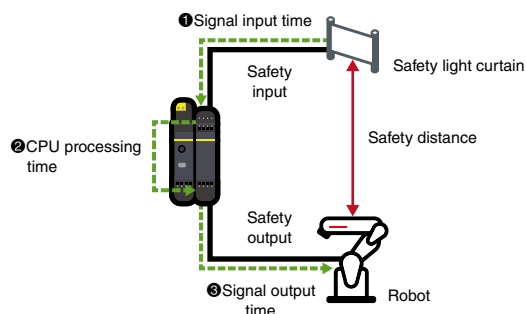

Fast shut off function is used

Response time = 8 ms

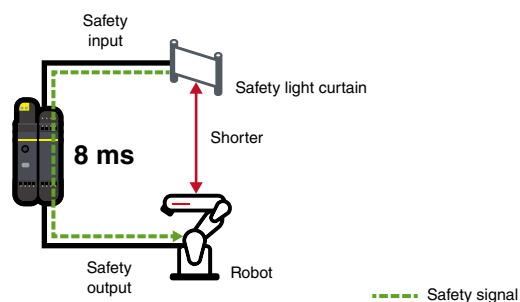

Flexi Line/Flexi Link

Safety communication network between safety controllers

Safety communications between safety controllers can be easily established at a low cost just by connecting the CPU modules with dedicated cables. Safety communication is realized without a dedicated network module, allowing utilization in various production site. In addition, coordination between multiple devices is possible, improving production system safety.

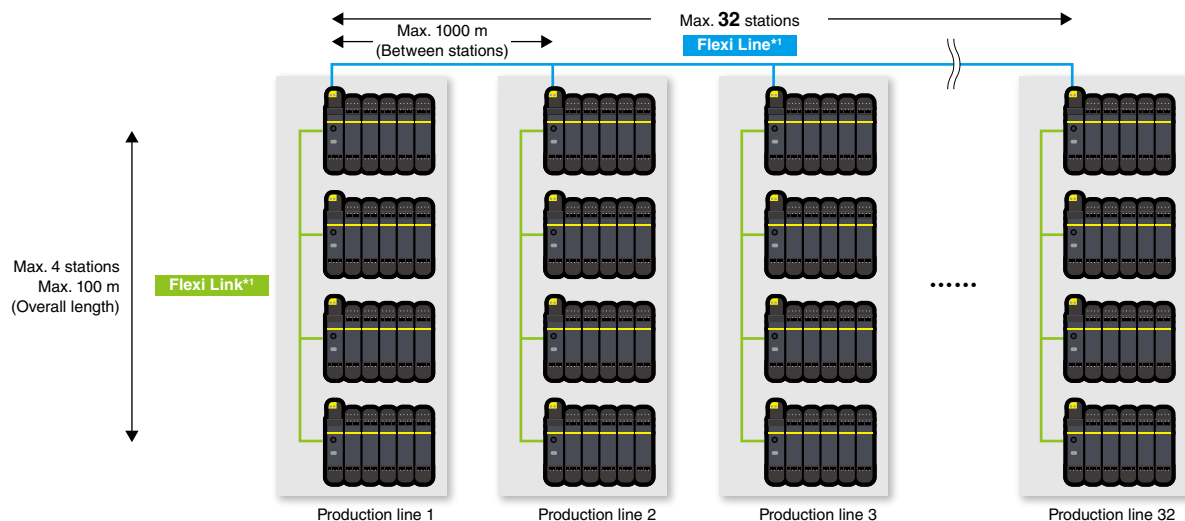

*1. Flexi Line is supported by WS0-CPU3 only and Flexi Link is supported by WS0-CPU1 and WS0-CPU3 only.

Dedicated “Setting and Monitoring Tool*1” provides intuitive system configuration environment

■ Configuration

Hardware configuration can be easily and quickly done using a wide range of elements*2.

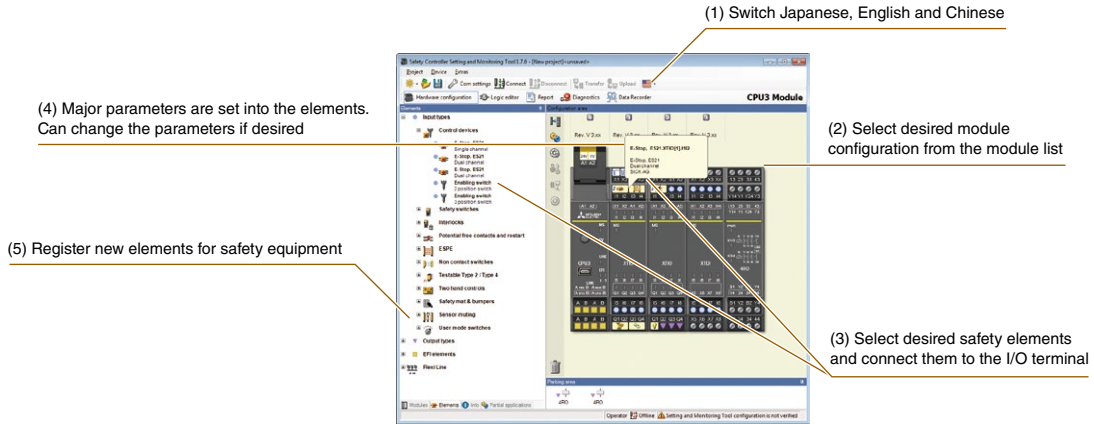

*1. For details on how to obtain the tool, please contact your local Mitsubishi Electric sales office or representative.

*2. Connecting parameters of major safety equipment, such as emergency stop switches, safety door switches and safety light curtains, are expressed by an icon. Make settings simply by drag-and-drop decision. Elements for safety devices of Mitsubishi’s partners are also available. Please contact your local Mitsubishi representative.

■ Logic editor

Elements connected to the I/O terminal are automatically labeled, enabling logic creation easier using labels and function blocks.

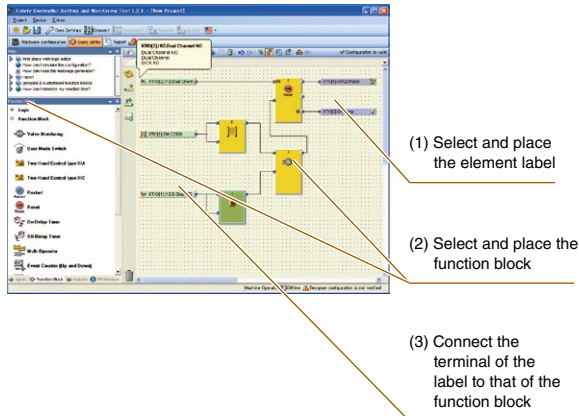

■ Diagnostics/monitor

Monitoring of the internal status of modules and error histories is possible.

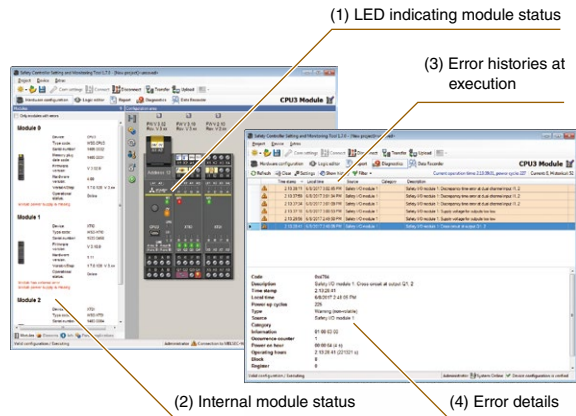

Report

The wiring diagram for I/O modules can be automatically created. Error diagnostics and other reports can be created, printed, and saved as PDF.

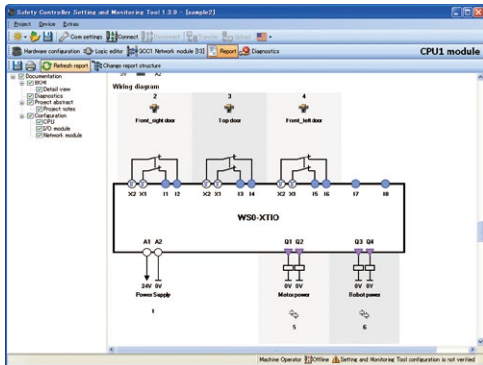

I/O matrix

The relation of inputs and outputs can be displayed as a matrix.

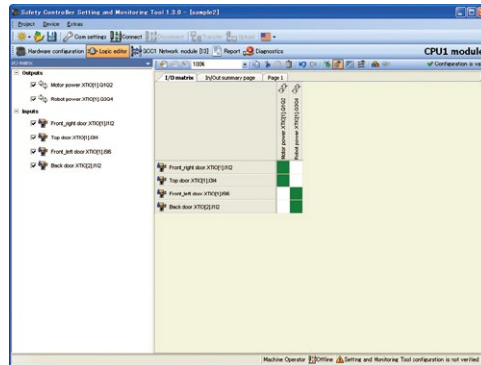

Data recorder

ON/OFF status of safety input signal and safety output signal processed by the safety controller can be stored. *1 Results recorded on the Setting and Monitoring Tool can also be viewed on the computer to utilize for troubleshooting.

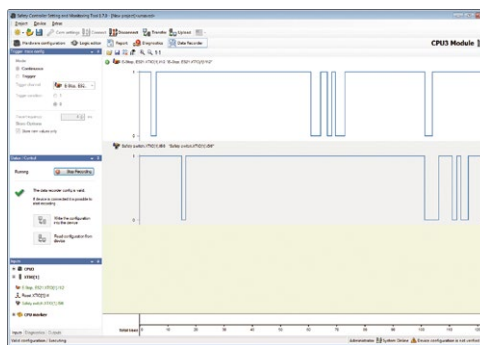

*1. Available when a CPU module with firmware version of V2.01 (revision 2.XX) or later and a Setting and Monitoring Tool of V1.7.0 or later are used together.

Import and export of logic

The connection settings to the I/O modules or application logic created with function blocks can be stored in a single setting file, and data can be read out of stored setting files.

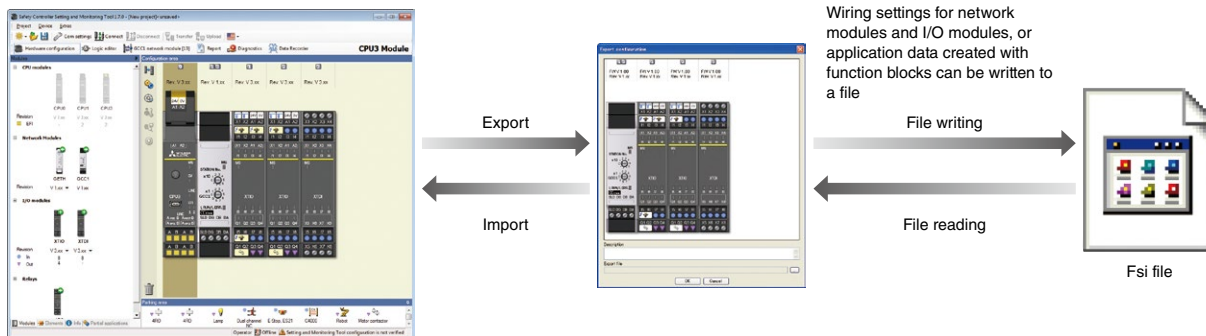

Application example

■ Press machine

The MELSEC-WS Series secures safety of standalone devices such as press machine. The MELSEC-WS Series are compact controllers with flexible features such as extendable I/Os, safety communication between CPUs, communication with a general programmable controller, and fast shut off function realizing faster response times.

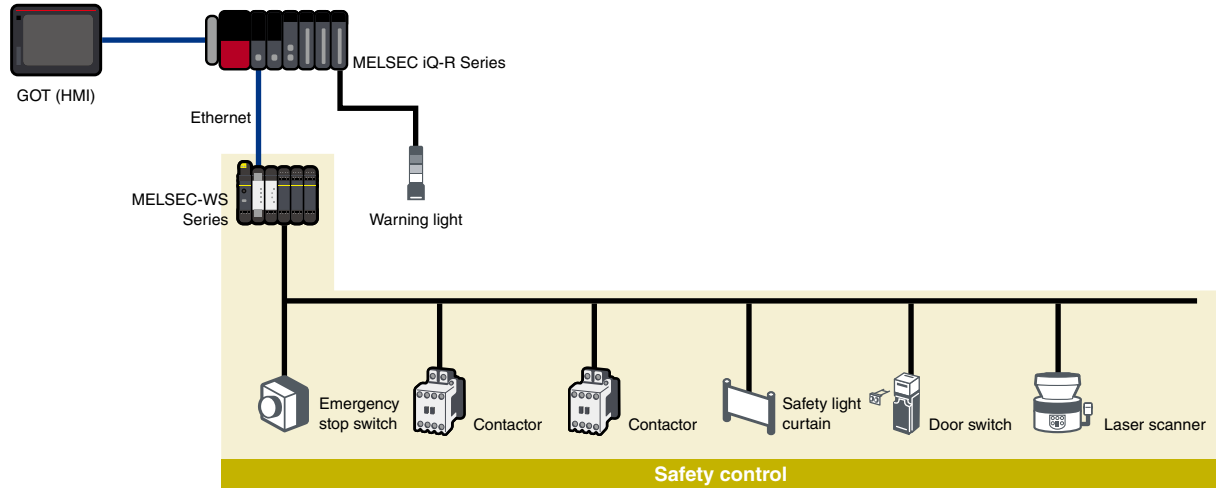
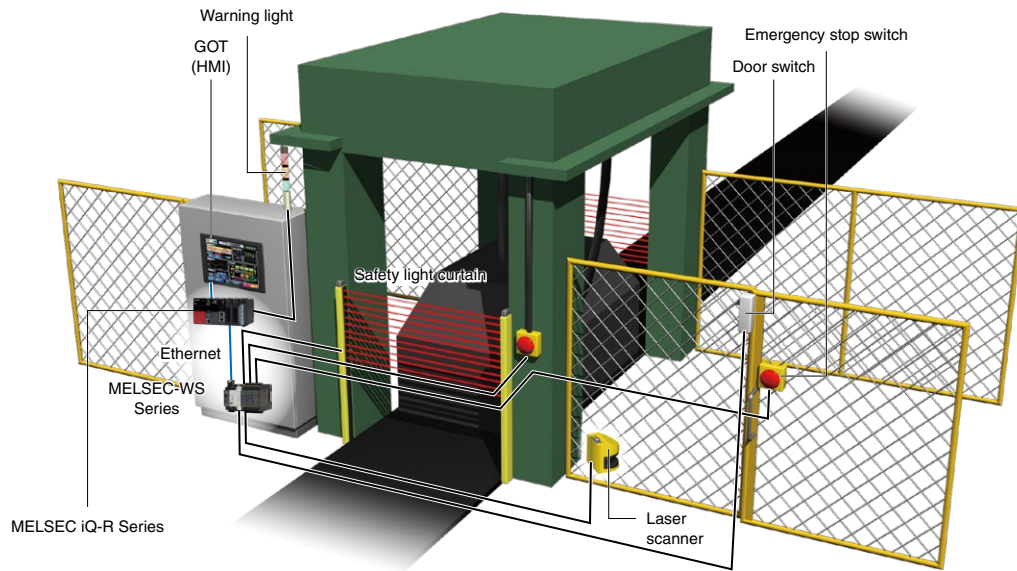

Specifications

CPU module specifications

Item	WS0-CPU0	WS0-CPU1	WS0-CPU3
Category	Category 4 (EN ISO 13849-1)		
Safety integrity level (SIL)	SIL 3 (IEC 61508)		
Performance level (PL)	PL e (EN ISO 13849-1)		
PFHd (probability of a dangerous failure per hour)	1.07 x 10 ⁻⁹	1.69 x 10 ⁻⁹	
Degree of protection (EN/IEC 60529)	Terminals: IP20, Housing: IP40		
EMC	EN 61000-6-2, EN 55011 (class A)		
Protection class	3		
Number of EFI interfaces	0	2	
Number of Flexi Line interfaces	0		2
Configuration interface	RS-232		RS-232, USB
Weight (kg)	0.11	0.12	0.13
External dimensions (H x W x D, mm)	96.5 x 22.5 x 120.8		101.7 x 22.5 x 120.8

CC-Link interface module specifications

Item	WS0-GCC1
Station type	Remote device station
CC-Link version	Ver.1.10
Number of stations occupied	1...4
Max. number of connectable modules	Max. 64 stations (number of stations connectable to one master station)
Connection cable	Ver.1.10 compatible CC-Link dedicated cable
Degree of protection (EN/IEC 60529)	Terminals: IP20, Housing: IP40
External dimensions (H x W x D, mm)	96.5 x 22.5 x 120.8

Ethernet interface module specifications

Item	WS0-GETH
Network type	Ethernet (TCP/IP) 100Base-TX 10Base-T
Number of connections	Max. 4 connections + 1 connection (for Setting and Monitoring Tool only)
Degree of protection (EN/IEC 60529)	Terminals: IP20, Housing: IP40
External dimensions (H x W x D, mm)	96.5 x 22.5 x 120.8

Safety input and I/O combined modules specifications

Item	WS0-XTIO	WS0-XTDI
Category	Category 4*1 (EN ISO 13849-1)	Category 4 (EN ISO 13849-1)
Safety integrity level (SIL)	SIL 3 (IEC 61508)	
Performance level (PL)	PL e (EN ISO 13849-1)	
PFHd	0.9 x 10 ⁻⁹ (for dual channel outputs) 4.8 x 10 ⁻⁹ (for single channel outputs)	0.4 x 10 ⁻⁹
Degree of protection (EN/IEC 60529)	Terminals: IP20, Housing: IP40	
EMC	EN 61000-6-2, EN 55011 (class A)	
Protection class	3	
Weight (kg)	0.16	0.14
Number of input points	8 (single), 4 (double)	
Number of output points	4 (single), 2 (double)	-
External dimensions (H x W x D, mm)	106.5 x 22.5 x 120.8	

*1. It depends on the connection and setting methods with safety output devices. Please refer to the manual for the details.

Safety relay output module specifications

Item	WS0-4RO	
Category	Category 4 (EN ISO 13849-1)	
Safety integrity level (SIL)	SIL 3 (IEC 61508)	
PFHd	1.2 x 10 ⁻⁹ (I = 0.75 A, switching frequency = 1/h)*2	
Degree of protection (EN/IEC 60529)	Terminals: IP20, Housing: IP40	
EMC	EN 61131-2, EN 61000-6-2, EN 55011 (class A)	
Weight (kg)	0.19	
Output circuit specs (13-14, 23-24, 33-34, 43-44)	2 (double output)	
Number of NO contacts	2 (double output)	
Output circuit specs (Y1-Y2, Y3-Y4)	2	
Number of NC contacts	2	
Output circuit specs (Y14, Y24)	2	
Number of NO contacts	2	
External dimensions (H x W x D, mm)	106.5 x 22.5 x 120.8	

*2. It depends on output current or other output values. Please refer to the manual for the details.



Safety Extension Modules

MELSEC iQ-F Series

Powered by
SICK

The MELSEC iQ-F Series safety extension module was developed and manufactured by SICK AG. SICK is a German supplier of safety solutions. For more information, please refer to the relevant product manuals or contact your local Mitsubishi Electric sales office or representative.

The MELSEC iQ-F Series safety extension module is compliant with international safety standards EN ISO 13849-1 Category 4 PL e and IEC 61508 SIL 3. Safety control of a small sized equipment is easily realized with easier settings without a program. Just connecting with the CPU module executes safety control, enabling both general and safety control in one system.

System configuration

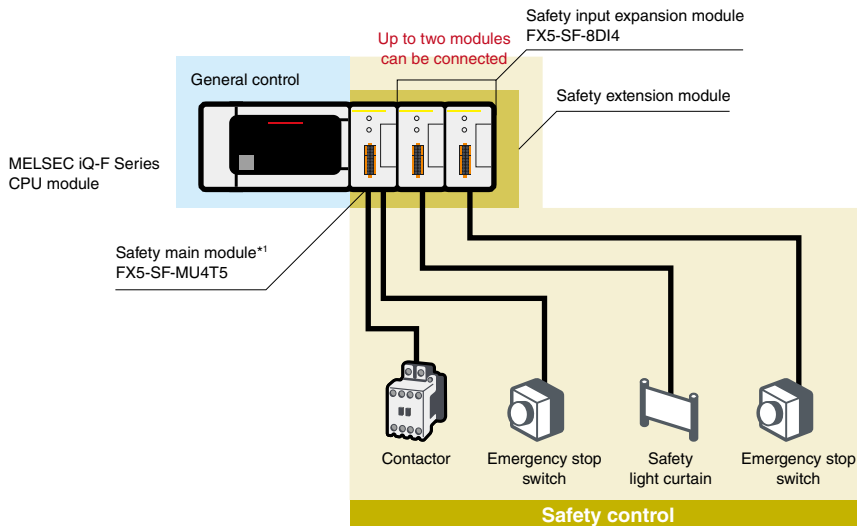

*1. Up to one safety main module can be connected. The extension module for general control cannot be connected following the safety extension module.

Realizes safety control with less wiring and minimal space

The safety control system can be configured by connecting the safety extension modules with the CPU module. Wiring for safety control monitoring and logic wiring between safety relays are no longer required, reducing wiring cost and space.

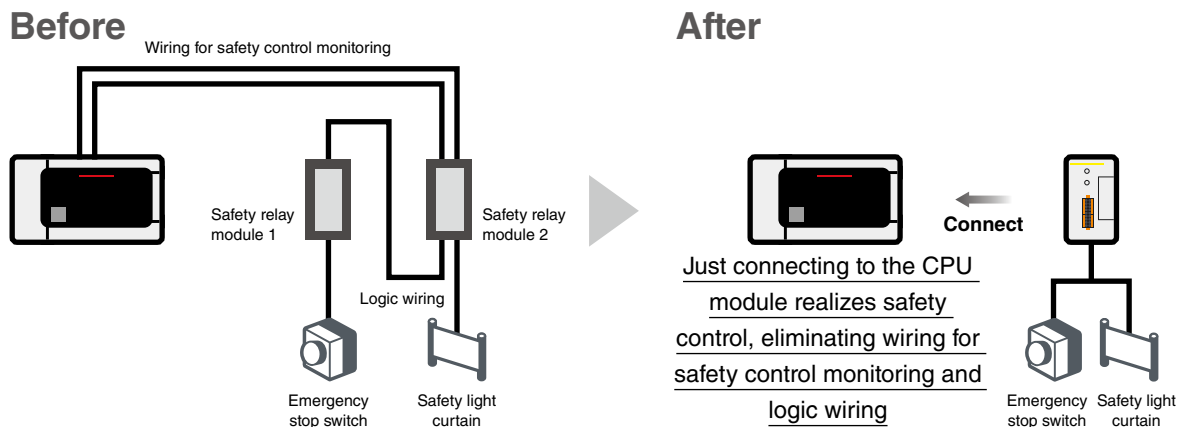

Turn the rotary switch to select a built-in program

Each safety main module and safety input expansion module has nine different programs installed. The safety control system can be configured simply by selecting a program with the rotary switch on the front and enabling the setting. It is no longer necessary to create a control program for safety control.

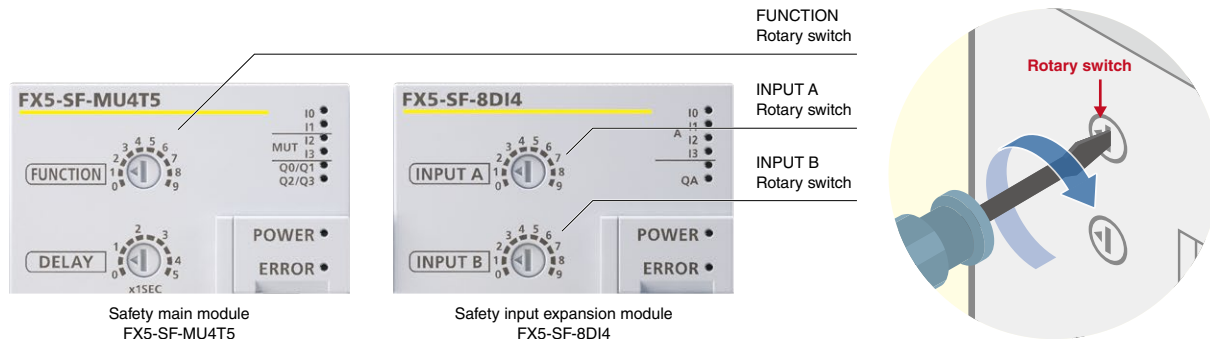

Program list

Program	Safety main module FX5-SF-MU4T5	Safety input expansion module FX5-SF-8DI4
0		Inactive
1	OR control (1)	AND link (single channel)
2	OR control (2)	AND link (dual channel) (1)
3	Muting control	AND link (dual channel) (2)
4	Two-hand control (1)	AND link (dual channel) (3)
5	Two-hand control (2)	AND link (dual channel) (4)
6	AND control (1)	AND link (dual channel) (5)
7	AND control (2)	OR link (dual channel)
8	Independent control	Bypass
9	AND control (3)	All paths batch connection

Interconnectivity with external devices visualizes the equipment status

Information can be shared on the factory floor through interconnectivity between devices utilizing built-in function of the FX5U/FX5UC/FX5UJ CPU modules and a GOT (HMI). Additionally, the safety status of equipment can be monitored (including error monitoring and information collection) via network from an office or other remote locations.

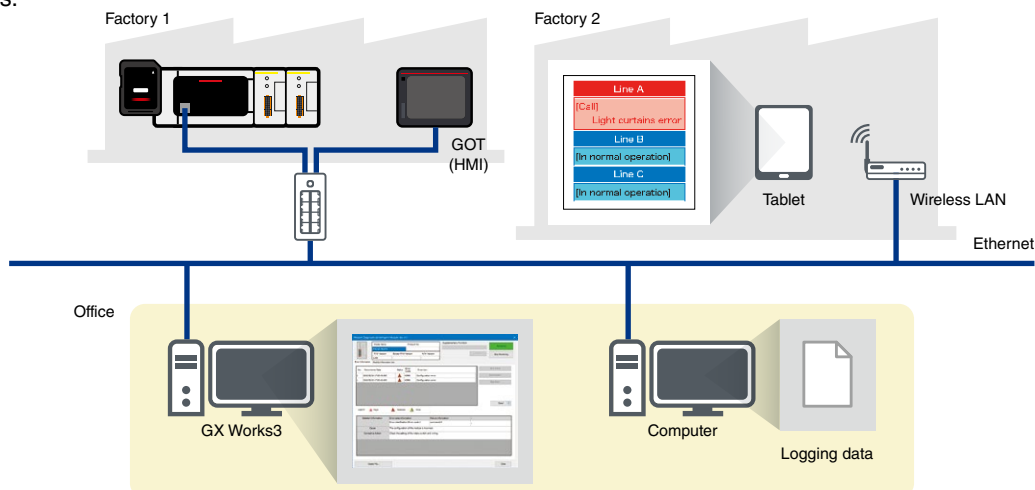

Safety Extension Modules

Check the wiring with Safety Extension Module Configuration Guide

The MELSEC iQ-F Series Safety Extension Module Configuration Guide*1 is a useful tool to check the system configuration, settings, and wiring of the safety extension module. Connected terminals of I/O devices, wiring diagram, and rotary switch setting change can be checked and also the created wiring diagram can be printed.

- 1 Place the safety extension module.
- 2 Click the device to connect.
- 3 Select the connection destination.
- 4 The set device is applied to the configuration.

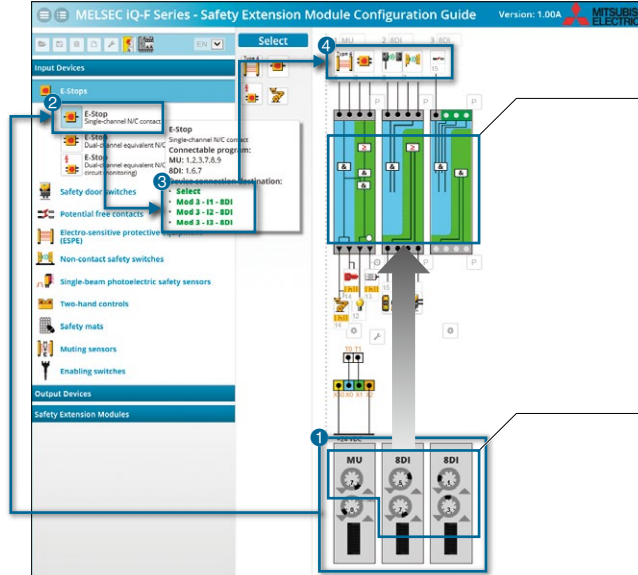

The displayed program outline changes to match the selected program number.

Set the program number with the rotary switch.

*1. For details on how to obtain the tool, please contact your local Mitsubishi Electric sales office or representative.

Module diagnostics with GX Works3

Safety extension module information such as its I/O, settings, and error codes is stored in the buffer memory in the safety main module. The error history can be recorded up to 16 items. When an error occurs, information such as the error details or countermeasures can be checked from the module diagnostics function of the engineering software GX Works3, making troubleshooting easier.

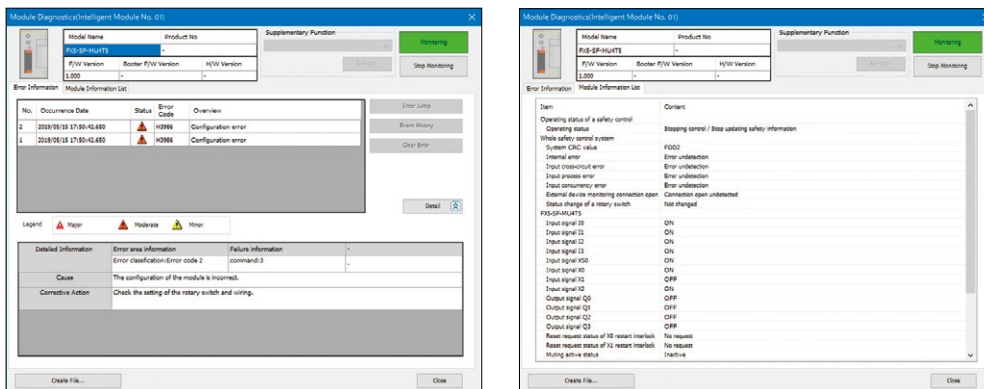

Settings and I/O status of the safety devices can be checked from the buffer memory. General control operation can be changed under safe control (when equipment is under safe operation or at an emergency stop). Since monitoring of the status is possible from the CPU module, settings of control program can be checked to notify the operator for measures, reducing troubleshooting time.

Notify that program 7 is not set to the set program

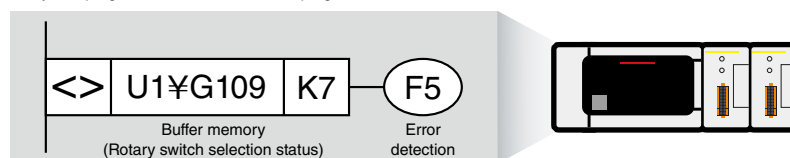

Notifying that program 7 is not set

Application example

■ Packaging machine

When a safety extension module is embedded with a packaging machine, pressing a safety emergency stop switch stops all the safety contactors. While, a safety light curtain detects a person, only the safety contactors of the processing part will stop.

Program number: 7 Overview: AND control (2)

- When the safety emergency stop switch is pressed, all the safety contactors are stopped **Entire stop**
- When the safety light curtains detect a person, only the safety contactors in the processing part are stopped **Partial stop**

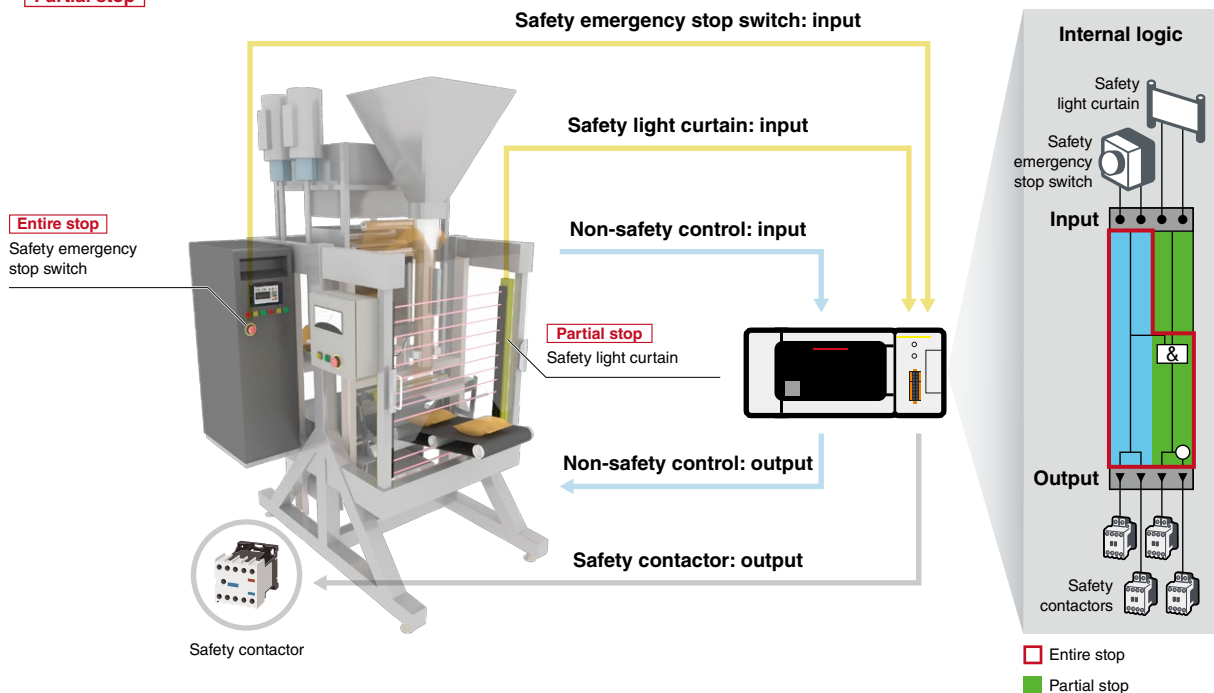

Specifications

Item	Safety main module FX5-SF-MU4T5	Safety input expansion module FX5-SF-8DI4
Category		Category 4 (EN ISO 13849-1)
Safety integrity level (SIL)		SIL 3 (IEC 61508, EN IEC 62061)
Performance level (PL)		PL e (EN ISO 13849-1)
PFHd (probability of a dangerous failure per hour)		1.5×10^{-8}
EMC		EN 61000-6-2, EN 61131-2, EN 61326-3-1, EN 55011 (class A)
T _M (mission time)		20 years (EN ISO 13849-1)
Weight (kg)	0.3	0.25
External dimensions (H x W x D, mm)		90 x 50 x 102.2
Safety input		
Number of input points	4 (single), 2 (double)	8 (single), 4 (double)
Safety output		
Number of output points	4 (single), 2 (double)	-
Supported conditions		
Compatible CPU module	FX5U/FX5UC: Ver. 1.200 or later, FX5UJ: Ver. 1.010 or later	
Engineering software	FX5U/FX5UC: GX Works3 Ver. 1.060N or later, FX5UJ: GX Works3 Ver. 1.075D or later	

Safety Components partner products

MITSUBISHI ELECTRIC ENGINEERING COMPANY LIMITED

Supporting each manufacturing site under the concept of “Fields of manufacturing are changing and to be changed”

Our products can offer innovative solutions by reducing wiring work for Mitsubishi Electric products such as programmable controllers, servo systems, and HMIs (GOTs).

For modules with safety functions, vibration-resistant spring clamp terminals provide efficient wiring and stable connection in production sites.

Spring-clamp terminal block wiring in 99% less time

■ Cable with spring-clamp terminal block

- Improving two processes (cable terminal processing and one-by-one connection) reduces wiring time by 99%
- 0.3 mm² (max. 4 A) and 0.75 mm² (max. 8 A) cables are selectable according to applications
- Cables can be used for 18-/34-/40-pin spring-clamp terminal block of the programmable controller

For spring-clamp terminal block 40P (1, 2, 3 m)

FA1-CB3L03SQ□□E1F40

FA1-CB3L07SQ□□E1F40

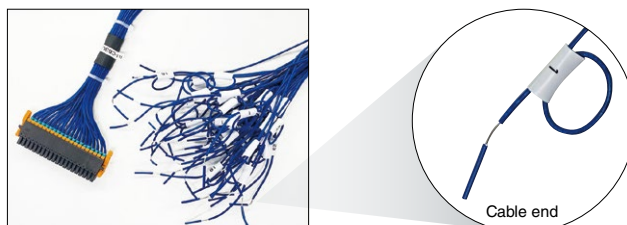

Compatible products*1

Type	Model
CC-Link IE TSN block-type safety remote I/O modules	NZ2GNSS2-8D, NZ2GNSS2-8TE, NZ2GNSS2-16DTE
CC-Link IE Field Network block-type safety remote I/O modules	NZ2GFSS2-8D, NZ2GFSS2-32D, NZ2GFSS2-8TE, NZ2GFSS2-16DTE, NZ2EXSS2-8TE

*1. Discrete cables connectable to the MELSEC iQ-R/iQ-F Series with spring-clamp terminal block type (18P, 34P) are also available.

MITSUBISHI ELECTRIC ENGINEERING COMPANY LIMITED

NAGOYA ENGINEERING OFFICE | 1-9, Daiko-Minami, 1-Chome, Higashi-ku, Nagoya, Aichi 461-0047 Japan

Website



www.mitsubishielectricengineering.com/sales/fa/meefan/

► Contact US





Providing safety devices to cover a wide range of requirements, assuring a safe environment for operators and machines

By thoroughly pursuing safety of environment where humans and machines work together, IDEC Corporation develops products and proposes system giving safety top priority to ensure personnel safety even if machines become faulty or operators make a mistake. To enhance safety and productivity,

IDEC provides a variety of functional safety products. IDEC also supports customers to improve safety at production sites by providing support with appropriate safety products and safety systems according to risks.



Interlock switches
HS1, HS3, HS5, HS6

Interlock switches allow a machine to start only when the guard is closed or the closed guard is locked.



Safety laser scanner SE2L
Safety light curtains SE4D

Safeguard by optoelectronic technology. Laser scanner is the world smallest with protection zone of 5 m and 270° and high spec. type with master-slave function. Connection terminal with a built-in force guided relay is also available.



Emergency stop switches
XA, XW, XN

IDEC's unique technology achieves high safety levels and satisfies international safety requirements.



Enabling switches
HE2B, HE3B, HE6B

Safety devices for preventing unexpected starting of a machine when operation is required in the hazardous area inside the guard.

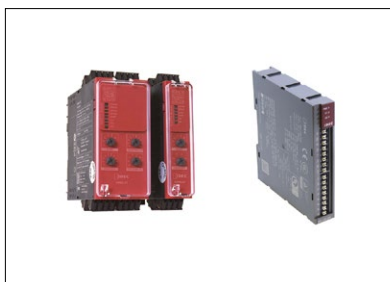

Safety relay modules
HR5S, HR6S

Advanced diagnostic and output functions available with the new HR6S. Categories 1 to 4 can be achieved with HR5S and HR6S safety relay modules.

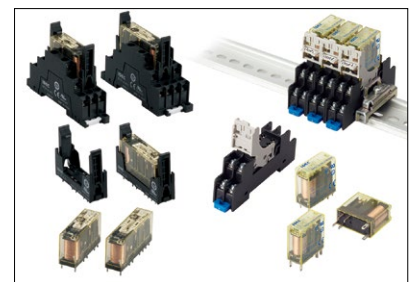

Force guided relays
RF1, RF2

Detects contact welding. 2-, 4-, and 6-pole forced guided relays available.

IDEC CORPORATION

Head Office 6-64, Nishi-Miyahara-2-Chome, Yodogawa-ku, Osaka 532-0004, Japan

USA IDEC Corporation
EMEA APEM SAS

Singapore IDEC Izumi Asia Pte. Ltd.
Thailand IDEC Asia (Thailand) Co., Ltd.
India IDEC Controls India Private Ltd.

China IDEC (Shanghai) Corporation
IDEC Izumi (H.K.) Co., Ltd.
Taiwan IDEC Taiwan Corporation

Japan IDEC Corporation

 www.idec.com



Sensor Intelligence.

State-of-the-art safety system to satisfy international standard

Important factor is the safety of the operations at each process and of the automated production facility, in addition to increase the efficiency and speed. It needs to be equipped for safety, even beyond the reach of human eyes when automated facility is operated. SICK safety products are able to support ideal safety system for automated facility. The product lineup

includes state-of-the-art sensors that satisfy high level of European safety standards. Products with the top market share in Europe provide strong support for safety measures in automated facilities all over the globe.



The world's smallest safety laser scanner nanoScan3 Pro I/O

Innovative safeHDDM[®] scanning technology. Scanning angle: 275°, protective field range: 3.0 m. Safety collision prevention and localization for AGC, AGV, and AMR (Autonomous Mobile Robot).



Safety multibeam scanner scanGrid2 I/O

LiDAR multibeam scanner with safe solid state technology, distance measured by TOF. Scanning angle: 150°, protective field range: 1.1 m. Mobile platform application is achieved in low cost.

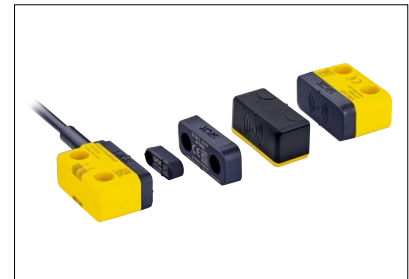

Transponder safety switches STR1

High level of manipulation protection due to individually coded actuator. Up to 30 switches connected in series. Fast diagnosis via LED status indicator. Safety Output: OSSD Type.



Safety laser scanner microScan3 Pro I/O

Innovative safeHDDM[®] scanning technology. Scanning angle: 275°, protective field range: 4.0 m, 5.5 m, and 9.0 m. Realizes reliable performance immune to ambient light and dust.



Safety light curtain deTec4

Max. scanning range: 30 m, max. protective field height: 2100 mm, up to 3 sensors connected in cascade. Fast commissioning and installation by NFC diagnosis or diagnostics and automation via IO-Link.

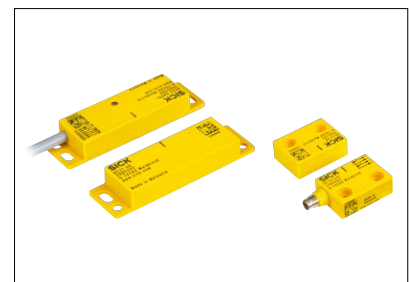

Non-contact safety switches RE1, RE2

Door opening detected by non-contact switch, response range up to 7 mm (RE1), 9 mm (RE2). Robust and long service life due to durable and low-maintenance design. Space-saving mounting due to compact housing design.

SICK AG

Erwin-Sick-Str. 1 79183 Waldkirch Germany

TEL +49 (0)7681 202-0

URL www.sick.com

Panasonic

INDUSTRY

Diverse lineup of variety of safety light curtains and safety sensors

Safety regulations have been implemented around the world and safety product designs according to the risk level is the fundamental requirement. Panasonic Industry's safety light curtains and safety sensors, with their

concept of "support for both safety and productivity", keep evolving and are available in a wide variation through extensive global distribution network.

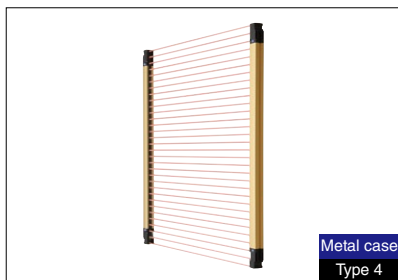

Safety light curtain
SF4D Series

The SF4D Series are standard safety light curtains featuring robust and high-performance, and available from variety of types supporting minimum sensing object, Japanese press, etc.

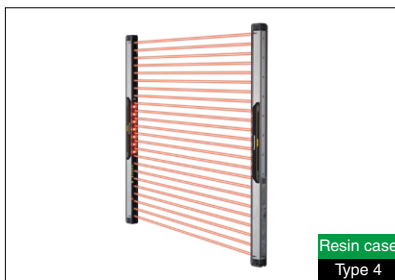

Compact safety light curtain
SF4B-C Series

Realizes "compact", "light", and "optimum cost". Mounts flush on aluminum frames. Compact profile design, maximize the machinery opening area.

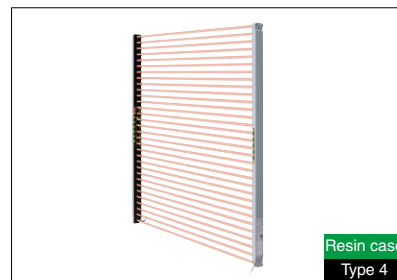

Ultra-slim safety light curtain
SF4C Series

Ultra-slim type with a slimness of 13 mm. Finger type with a shorter safety distance fits into a smaller equipment.

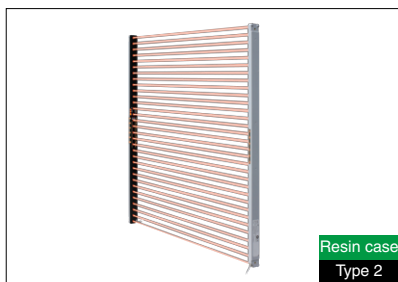

Ultra-slim safety light curtain
SF2C Series

Competitively priced Type 2 has been added to the Ultra-slim type Series with a slimness of 13 mm. Reduces wiring and adjusting beam axis is easy.



Safety beam sensor
ST4 Series

Safety beam sensor that can be used from a single beam axis. A standard sensor size can ensure safety in a narrow area.



Non-contact safety door switch
SG-P Series

Large and bright indicators show the open/close conditions of all equipment doors.

Panasonic Industry Co., Ltd. Industrial Device Business Division

URL industrial.panasonic.com/ac/e/

EUCHNER

EUCHNER - More than Safety

EUCHNER is a pioneer and world leader for Safety Systems for safeguarding humans and processes machine doors and safety guards. For more than 60 years, EUCHNER has been developing and producing high-quality electromechanical and electronic systems. Industrial safety engineering is our

core business. Our safety switches and electronic key system reliably safeguard and monitor safety doors on machines and installations. We help to minimize risks and to increase product quality and productivity.



Multifunctional Gate Box MGB/MGB2/MGBS

Among safeguarding against dangerous machine movements, the MGB combines integrated operating functions with a simple and robust design. Intuitive operation is guaranteed.



Transponder-coded safety switches with guard locking CET/CTP/CEM/CTA

Safety switches with guard locking are used to prevent unintentional opening of a safety doors or covers while dangerous machine movements are being performed.



Transponder-coded safety switches with guard locking CES

CES safety switches monitor safety doors and covers on machines and installations. Depending on the application, various technologies and functional principles are available.



Key Adapter for external Transponder-coded evaluation CKS

CKS provides enhanced key reading for safety applications in PL e Category 4. Versatile use, e.g. as a lockout mechanism, authorization for selecting operating modes, key transfer system.



Electronic-Key-System EKS

Typical applications for the EKS are the controlling and management of access rights for machinery. The EKS is an open system specifically designed for industrial use.



Enabling switches ZS

Enabling switches are used wherever personnel must work in the danger area on machines and installations. The robust and ergonomic design is suitable for numerous applications.

EUCHNER GmbH + Co. KG KohlhammerstraBe 16 D-70771 Leinfelden-Echterdingen

TEL +49 711 7597-0

FAX +49 711 753316

URL www.euchner.de

Discover the latest information in Factory Automation

Factory Automation Global website

Mitsubishi Electric Factory Automation provides a mix of services to support its customers worldwide. A consolidated global website is the main portal, offering a selection of support tools and a window to its local Mitsubishi Electric sales and support network.

■ From here you can find:

- Overview of available factory automation products
- Library of downloadable literature
- Support tools such as online e-learning courses, terminology dictionary, etc.
- Global sales and service network portal
- Latest news related to Mitsubishi Electric factory automation

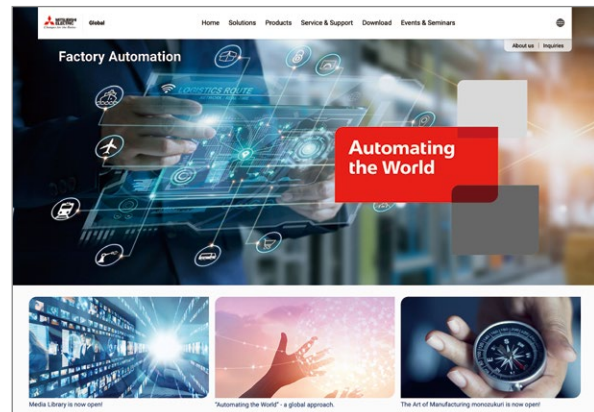

**Mitsubishi Electric Factory Automation
Global website:
www.MitsubishiElectric.com/fa**

Online e-learning

An extensive library of e-learning courses covering the factory automation product range has been prepared. Courses from beginner to advanced levels of difficulty are available in various languages.



■ Beginner level

Designed for newcomers to Mitsubishi Electric Factory Automation products gaining a background of the fundamentals and an overview of various products related to the course.

■ Basic to Advanced levels

These courses are designed to provide education at all levels. Various different features are explained with application examples providing an easy and informative resource for in-house company training.

Find information on products, factory automation, e-F@ctory solutions and other topics

Follow us on Social Media

■ YouTube



Mitsubishi Electric FA Global

■ LinkedIn



Mitsubishi Electric FA Global

■ Twitter



Mitsubishi Electric official Twitter
[@Mitsubishi_FA](https://twitter.com/Mitsubishi_FA)

Innovative next-generation, e-Manual

e-Manual Viewer

The e-Manual viewer is a next-generation digital manual offered by Mitsubishi Electric that consolidates factory automation products manuals into an easy-to-use package with various useful features integrated into the viewer. The e-Manual allows multiple manuals to be cross-searched at once, further reducing time for setting up products and troubleshooting.



Key features included

- One-stop database containing all required manuals, with local file cache
- Included with GX Works3 engineering software
- Also available in tablet version
- Easily download manuals all at once
- Multiple users can share the latest manuals and knowhow with document sharing function
- Directly port sample programs within manuals to GX Works3
- Downloaded manuals are usable offline

Windows®-compliant



e-Manual Create

e-Manual Create is software for converting word files and chm files to e-Manual documents. e-Manual Create allows users to directly refer to Mitsubishi Electric e-Manuals from user's customized device maintenance manuals and such, supporting quick troubleshooting and reduction in document creation process.

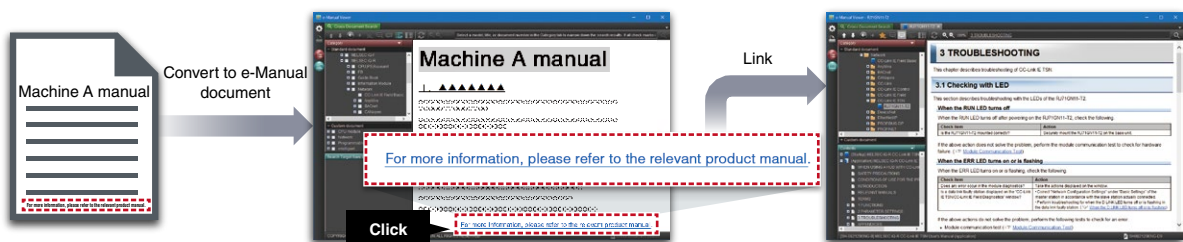

Windows®-compliant



* To obtain the Windows® version of e-Manual Viewer and e-Manual Create, please contact your local Mitsubishi Electric sales office or representative.

CC-Link Partner Association (CLPA) - Actively promoting worldwide adoption of CC-Link networks

Proactively supporting CC-Link, from promotion to specification development

The CC-Link Partner Association (CLPA) was established to promote the worldwide adoption of the CC-Link open-field network. By conducting promotional activities such as organizing trade shows and seminars, conducting conformance tests, and providing catalogs, brochures and website information, CLPA activities are successfully increasing the number of CC-Link partner manufacturers and CC-Link-compatible products. As such, CLPA is playing a major role in the globalization of CC-Link.



Seminar

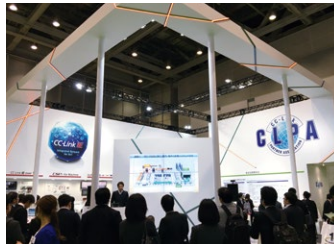

Trade show



Conformance testing lab

■ Visit the CLPA website for the latest CC-Link information.



CLPA website
www.cc-link.org/en



CLPA Headquarters

6F Ozone Front Bldg. 3-15-58 Ozone
Kita-ku, Nagoya 462-0825, JAPAN
TEL: +81-52-919-1588 FAX: +81-52-916-8655
e-mail: info@cc-link.org

Global influence of CC-Link continues to spread

CC-Link is supported globally by CLPA. With offices throughout the world, support for partner companies can be found locally. Each regional CLPA office undertakes various support and promotional activities to further the influence of CC-Link/CC-Link IE in that part of the world. For companies looking to increase their presence in their local area, CLPA is well placed to assist these efforts through offices in all major regions.

CLPA-Europe **CT**
(Germany)

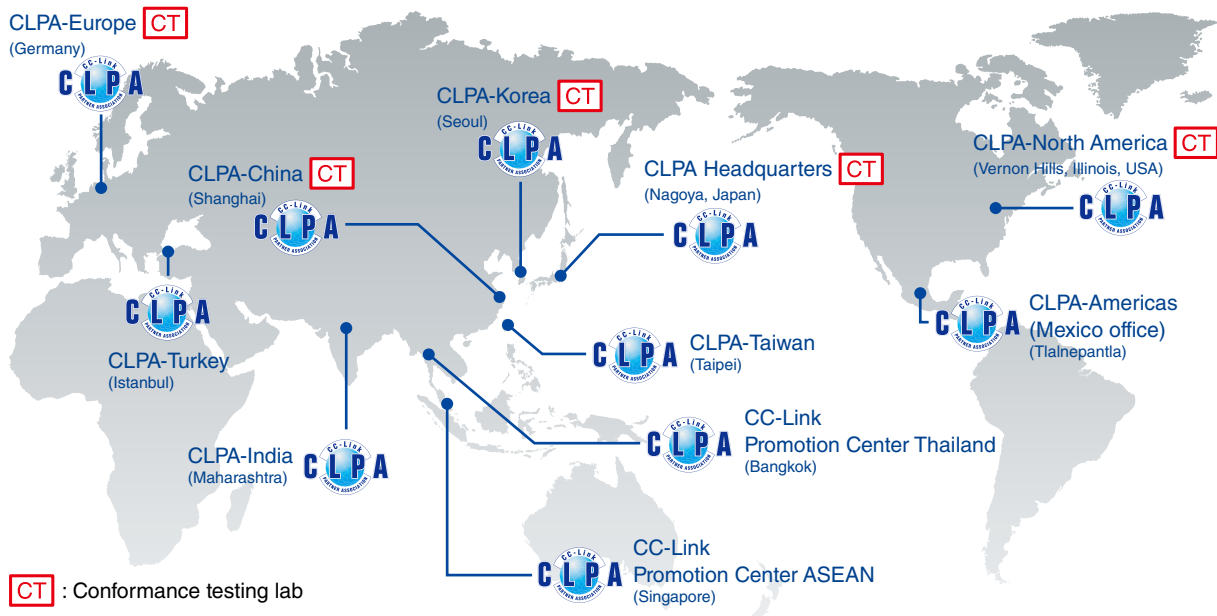

CT : Conformance testing lab

Extensive global support coverage providing expert help whenever needed

Global FA centers

EMEA

Europe FA Center

MITSUBISHI ELECTRIC EUROPE B.V. Polish Branch
Tel: +48-12-347-65-00

Germany FA Center

MITSUBISHI ELECTRIC EUROPE B.V. German Branch
Tel: +49-2102-486-0 / Fax: +49-2102-486-7780

UK FA Center

MITSUBISHI ELECTRIC EUROPE B.V. UK Branch
Tel: +44-1707-27-8780 / Fax: +44-1707-27-8695

Czech Republic FA Center

MITSUBISHI ELECTRIC EUROPE B.V. Czech Branch
Tel: +420-734-402-587

Italy FA Center

MITSUBISHI ELECTRIC EUROPE B.V. Italian Branch
Tel: +39-039-60531 / Fax: +39-039-6053-312

Turkey FA Center

MITSUBISHI ELECTRIC TURKEY ELEKTRIK URUNLERI A.S.
Tel: +90-216-969-2500 / Fax: +90-216-661-4447

Asia-Pacific

China

Beijing FA Center

MITSUBISHI ELECTRIC AUTOMATION (CHINA) LTD. Beijing FA Center
Tel: +86-10-6518-8830 / Fax: +86-10-6518-2938

Guangzhou FA Center

MITSUBISHI ELECTRIC AUTOMATION (CHINA) LTD. Guangzhou FA Center
Tel: +86-20-8923-6730 / Fax: +86-20-8923-6715

Shanghai FA Center

MITSUBISHI ELECTRIC AUTOMATION (CHINA) LTD. Shanghai FA Center
Tel: +86-21-2322-3030 / Fax: +86-21-2322-3000

Tianjin FA Center

MITSUBISHI ELECTRIC AUTOMATION (CHINA) LTD. Tianjin FA Center
Tel: +86-22-2813-1015 / Fax: +86-22-2813-1017

Taipei FA Center

SETSUYO ENTERPRISE CO., LTD.
Tel: +886-2-2299-9917 / Fax: +886-2-2299-9963

Korea

Korea FA Center

MITSUBISHI ELECTRIC AUTOMATION KOREA CO., LTD.
Tel: +82-2-3660-9632 / Fax: +82-2-3664-0475

Thailand

Thailand FA Center

MITSUBISHI ELECTRIC FACTORY AUTOMATION (THAILAND) CO., LTD.
Tel: +66-2682-6522-31 / Fax: +66-2682-6020

ASEAN

ASEAN FA Center

MITSUBISHI ELECTRIC ASIA PTE. LTD.
Tel: +65-6470-2480 / Fax: +65-6476-7439

Malaysia

Malaysia FA Center

Malaysia FA Center
Tel: +60-3-7626-5080 / Fax: +60-3-7658-3544

Indonesia

Indonesia FA Center

PT. MITSUBISHI ELECTRIC INDONESIA Cikarang Office
Tel: +62-21-2961-7797 / Fax: +62-21-2961-7794

Vietnam

Hanoi FA Center

MITSUBISHI ELECTRIC VIETNAM COMPANY LIMITED Hanoi Branch Office
Tel: +84-24-3937-8075 / Fax: +84-24-3937-8076

Ho Chi Minh FA Center

MITSUBISHI ELECTRIC VIETNAM COMPANY LIMITED
Tel: +84-28-3910-5945 / Fax: +84-28-3910-5947

Philippines

Philippines FA Center

MELCO Factory Automation Philippines Inc.
Tel: +63-(0)2-8256-8042

India

India Ahmedabad FA Center

MITSUBISHI ELECTRIC INDIA PVT. LTD. Ahmedabad Branch
Tel: +91-7965120063

India Bangalore FA Center

MITSUBISHI ELECTRIC INDIA PVT. LTD. Bangalore Branch
Tel: +91-80-4020-1600 / Fax: +91-80-4020-1699

India Chennai FA Center

MITSUBISHI ELECTRIC INDIA PVT. LTD. Chennai Branch
Tel: +91-4445548772 / Fax: +91-4445548773

India Coimbatore FA Center

MITSUBISHI ELECTRIC INDIA PVT. LTD. Coimbatore Branch
Tel: +91-422-438-5606

India Gurgaon FA Center

MITSUBISHI ELECTRIC INDIA PVT. LTD. Gurgaon Head Office
Tel: +91-124-463-0300 / Fax: +91-124-463-0399

India Pune FA Center

MITSUBISHI ELECTRIC INDIA PVT. LTD. Pune Branch
Tel: +91-20-2710-2000 / Fax: +91-20-2710-2100

Americas

USA

North America FA Center

MITSUBISHI ELECTRIC AUTOMATION, INC.
Tel: +1-847-478-2469 / Fax: +1-847-478-2253

Mexico

Mexico City FA Center

MITSUBISHI ELECTRIC AUTOMATION, INC. Mexico Branch
Tel: +52-55-3067-7500

Mexico FA Center

MITSUBISHI ELECTRIC AUTOMATION, INC. Queretaro Office
Tel: +52-442-153-6014

Mexico Monterrey FA Center

MITSUBISHI ELECTRIC AUTOMATION, INC. Monterrey Office
Tel: +52-55-3067-7599

Brazil

Brazil FA Center

MITSUBISHI ELECTRIC DO BRASIL COMERCIO E SERVICOS LTDA.
Tel: +55-11-4689-3000 / Fax: +55-11-4689-3016

General Specifications

General specifications*1

Item	MELSEC iQ-R Series Safety CPU module	MELSEC iQ-F Series Safety extension module*2					MELSEC-WS Series
Operating ambient temperature (°C)	0...55 (when a base unit other than an extended temperature range base unit is used)	-20...50					-25...55*4
	0...60 (when an extended temperature range base unit is used)*3						
Storage ambient temperature (°C)	-25...75					-25...70	
Operating ambient humidity (% RH)	5...95, non-condensing					10...95, non-condensing	
Storage ambient humidity (% RH)	5...95, non-condensing					10...95, non-condensing	
Vibration resistance	Compliant with JIS B 3502 and IEC 61131-2	-	Frequency	Constant acceleration	Half amplitude	Sweep count	10-500 Hz/5 g (EN 60068-2-6)
		Under intermittent vibration	5...8.4 Hz	-	3.5 mm	10 times each in X, Y, Z directions	
			8.4...150 Hz	9.8 m/s ²	-	-	
		Under continuous vibration	5...8.4 Hz	-	1.75 mm	-	
8.4...150 Hz	4.9 m/s ²		-	-			
Shock resistance	Compliant with JIS B 3502 and IEC 61131-2 (147 m/s ² , 3 times each in directions X, Y, Z)					Continuous shock: 10 g, 16 ms (EN 60068-2-29) Single shock: 30 g, 11 ms (EN 60068-2-27)	
Operating atmosphere	No corrosive gases*5, no flammable gases, no excessive conductive dust					55°C, 95% rel. humidity (IEC 61131-2) no corrosive gases	
Operating altitude*6 (m)	0...2000*7					0...2000 (80 kPa)	
Installation location	Inside a control panel						
Overvoltage category*8	≤ II						
Pollution degree*9	≤ 2						

*1. For general specifications of other products, please refer to the relevant product manuals.

*2. General specifications stated are the same as the CPU module connected.

*3. Enables standard MELSEC iQ-R Series modules to support extended operating ambient temperature of 0 to 60°C, ensuring the same performance as the standard operating ambient temperature (0 to 55°C). When requiring to use in an ambient temperature environment higher than 60°C, please consult your local Mitsubishi Electric representative.

*4. The operating ambient temperature of the WS0-GCC100202 is 0 to 55°C.

*5. The special coated product, which improves resistance to corrosive gas concentrations as specified in IEC 60721-3-3:1994 3C2, is available for the use in a corrosive gas environment. For more details on the special coated product, please consult your local Mitsubishi Electric representative.

*6. Do not use or store the programmable controller under pressure higher than the atmospheric pressure of altitude 0 m. Doing so may cause malfunction. When using the programmable controller under pressure, please consult your local Mitsubishi Electric representative.

*7. When used at an altitude higher than 2000 m, the upper limits of the permissible voltage and the operating ambient temperature become lower. Please consult your local Mitsubishi Electric representative.

*8. This indicates the section of the power supply to which the equipment is assumed to be connected between the public electrical power distribution network and the machinery within premises. Category 2 applies to equipment for which electrical power is supplied from fixed facilities. The surge voltage withstand level for up to the rated voltage of 300 V is 2500 V.



*9. This index indicates the degree to which conductive material is generated in terms of the environment in which the equipment is used.

Pollution level 2 is when only non-conductive pollution occurs. A temporary conductivity caused by condensing must be expected occasionally.

Product Lists

Product lists

Programmable automation controllers MELSEC iQ-R Series  : CC-Link IE TSN  : CC-Link IE Field Network  : Co-branded product*

Item	Model	Outline		
Safety CPU*2	R08SFPCU-SET	Program capacity: 80K steps (40K steps for safety programs); Basic operation processing speed (LD instruction): 0.98 ns	●	●
	R16SFPCU-SET	Program capacity: 160K steps (40K steps for safety programs); Basic operation processing speed (LD instruction): 0.98 ns	●	●
	R32SFPCU-SET	Program capacity: 320K steps (40K steps for safety programs); Basic operation processing speed (LD instruction): 0.98 ns	●	●
	R120SFPCU-SET	Program capacity: 1200K steps (40K steps for safety programs); Basic operation processing speed (LD instruction): 0.98 ns	●	●
Main base	R35B	5 slots	●	●
	R38B	8 slots	●	●
	R312B	12 slots	●	●
Power supply	R61P	AC power supply; Input: 100...240 V AC; Output: 5 V DC/6.5 A	●	●
	R62P	AC power supply; Input: 100...240 V AC; Output: 5 V DC/3.5 A, 24 V DC/0.6 A	●	●
	R63P	DC power supply; Input: 24 V DC; Output: 5 V DC/6.5 A	●	●
	R64P	AC power supply; Input: 100...240 V AC; Output: 5 V DC/9 A	●	●
CC-Link IE TSN master/local	RJ71GN11-T2	1 Gbps/100 Mbps; Master/local station	●	-
Motion	RD78G4	Max. number of control axes: 4; Linear/circular/helical interpolation	●	-
	RD78G8	Max. number of control axes: 8; Linear/circular/helical interpolation	●	-
	RD78G16	Max. number of control axes: 16; Linear/circular/helical interpolation	●	-
	RD78G32	Max. number of control axes: 32; Linear/circular interpolation	●	-
	RD78G64	Max. number of control axes: 64; Linear/circular interpolation	●	-
	RD78GHV	High-performance type; Max. number of control axes: 128; Linear/circular interpolation	●	-
	RD78GHW	High-performance type; Max. number of control axes: 256; Linear/circular interpolation	●	-
CC-Link IE Field Network master/local	RJ71GF11-T2	1 Gbps; Master/local station	-	●
Simple motion	RD77GF4	Max. number of control axes: 4; Linear/circular/helical interpolation; Advanced synchronous control	-	●
	RD77GF8	Max. number of control axes: 8; Linear/circular/helical interpolation; Advanced synchronous control	-	●
	RD77GF16	Max. number of control axes: 16; Linear/circular/helical interpolation; Advanced synchronous control	-	●
	RD77GF32	Max. number of control axes: 32; Linear/circular/helical interpolation; Advanced synchronous control	-	●
CIP Safety™	RJ71SEIP91-T4 	CIP Safety™ system-compatible; Scanner	-	-
MELSOFT GX Works3	SW1DND-GXW3-E	Version 1.015R or later	●	●

*1. General specifications and product guarantee conditions for co-branded products may vary from those of general MELSEC products. For more information, please contact your local Mitsubishi Electric sales office or representative.

*2. Product package includes a safety CPU module (R□SFPCU) and safety function module (R6SFM).





Block-type safety remote CC-Link IE TSN-compatible modules

Item	Model	Outline
Safety input	NZ2GNSS2-8D	Single wiring: 8 points; Double wiring: 4 points; 24 V DC; Response time: 1...70 ms; Negative common; Spring-clamp terminal block; 2-wire
Safety output	NZ2GNSS2-8TE	Single wiring: 8 points; Double wiring: 4 points; 24 V DC (0.5 A); Source + source; Spring-clamp terminal block; 2-wire
Safety I/O combined	NZ2GNSS2-16DTE	[Input] Single wiring: 8 points; Double wiring: 4 points; 24 V DC; Response time: 1...70 ms; Negative common [Output] Single wiring: 8 points; Double wiring: 4 points; 24 V DC (0.5 A); Source + source; Spring-clamp terminal block; 2-wire

Block-type safety remote CC-Link IE Field Network-compatible modules

Item	Model	Outline	Connectable device**	
			A	B
Safety input	NEW NZ2GFSS2-8D-S1*2	Single wiring: 8 points; Double wiring: 4 points; 24 V DC; Response time: 1...70 ms; Negative common; Spring-clamp terminal block; 2-wire	●	-
	NEW NZ2GFSS2-32D-S1*2	Single wiring: 32 points; Double wiring: 16 points; 24 V DC; Response time: 1...50 ms; Negative common; Spring-clamp terminal block; 2-wire	●	-
Safety output	NEW NZ2GFSS2-8TE-S1*2	Single wiring: 8 points; Double wiring: 4 points; 24 V DC (0.5 A); Source + source; Spring-clamp terminal block; 2-wire	●	-
Safety I/O combined	NEW NZ2GFSS2-16DTE-S1*2	[Input] Single wiring: 8 points; Double wiring: 4 points; 24 V DC; Response time: 1...70 ms; Negative common [Output] Single wiring: 8 points; Double wiring: 4 points; 24 V DC (0.5 A); Source + source; Spring-clamp terminal block; 2-wire	●	-

*1. MELSEC iQ-R Series safety CPU modules and master modules RJ71GF11-T2 that can be connected.





Please select products according to the firmware versions of the MELSEC iQ-R Series safety CPU modules and the master modules RJ71GF11-T2 to be used. For details and , , , and , please refer to page 15.

*2. Models with "-S1" at the end of their names support safety protocol version 2.

Block-type safety remote CC-Link IE Field Network-compatible modules



Item	Model	Outline	Connectable device**	
			A	B
Safety input	NZ2GFSS2-8D	Single wiring: 8 points; Double wiring: 4 points; 24 V DC; Response time: 1...70 ms; Negative common; Spring-clamp terminal block; 2-wire	●	●
	NZ2GFSS2-32D	Single wiring: 32 points; Double wiring: 16 points; 24 V DC; Response time: 1...50 ms; Negative common; Spring-clamp terminal block; 2-wire	●	●
Safety output	NZ2GFSS2-8TE	Single wiring: 8 points; Double wiring: 4 points; 24 V DC (0.5 A); Source + source; Spring-clamp terminal block; 2-wire	●	●
Safety I/O combined	NZ2GFSS2-16DTE	[Input] Single wiring: 8 points; Double wiring: 4 points; 24 V DC; Response time: 1...70 ms; Negative common [Output] Single wiring: 8 points; Double wiring: 4 points; 24 V DC (0.5 A); Source + source; Spring-clamp terminal block; 2-wire	●	●

*3. MELSEC iQ-R Series safety CPU modules and master modules RJ71GF11-T2 that can be connected.

Please select products according to the firmware versions of the MELSEC iQ-R Series safety CPU modules and the master modules RJ71GF11-T2 to be used. For details and , , , and , please refer to page 15.

Block-type remote modules with safety functions

: CC-Link IE TSN : CC-Link IE Field Network

Item	Model	Outline		
Extension safety output	NZ2EXSS2-8TE**4	Single wiring: 8 points; Double wiring: 4 points; 24 V DC; Source + source; Spring-clamp terminal block; 2-wire	-	●
Waterproof/dustproof type (IP67) I/O combined	NZ2GNS12A2-14DT	[Input] Single wiring: 12 points; Double wiring: 6 points; 24 V DC; Response time: 1...70 ms; Negative common [Output] Single wiring not possible; Double wiring: 2 points; 24 V DC (max. load current: 2 A/point, 4 A/point)**5 Source + sink; Waterproof connector; 2-wire	●	-
	NZ2GNS12A2-16DTE	[Input] Single wiring: 12 points; Double wiring: 6 points; 24 V DC; Response time: 1...70 ms; Negative common [Output] Single wiring: 4 points; Double wiring: 2 points; 24 V DC (max. load current: 2 A/point, 4 A/point)**5 Source + source; Waterproof connector; 2-wire	●	-

*4. Can be connected to NZ2GFSS2-32D and NZ2GFSS2-32D-S1 only.

*5. Maximum load current specifications may vary depending on the output terminals. For more information, please refer to the relevant product manual.

Product Lists

Safety controllers MELSEC-WS Series

DB : Co-branded product*1

Item	Model	Outline
CPU	WS0-CPU000200 (WS0-CPU0)* ² DB	Program capacity: 255 FBs; Scan cycle: 4 ms; RS-232 Interface
CPU (with EFI)	WS0-CPU130202 (WS0-CPU1)* ² DB	EFI-equipped (EFI is the communication interface for setting SICK's safety products.); Flexi Link with EFI; RS-232 Interface
CPU (with EFI, Flexi Line)	WS0-CPU320202 (WS0-CPU3)* ² DB	EFI-equipped (EFI is the communication interface for setting SICK's safety products.); Flexi Link with EFI; Flexi Line with EFI; RS-232 Interface; USB Interface
Memory plug for CPU	WS0-MPL000201 (WS0-MPL0)* ² DB	For storing CPU parameters and programs (required) (for WS0-CPU0/WS0-CPU1)
	WS0-MPL100201 (WS0-MPL1)* ² DB	For storing CPU parameters and programs (required) (for WS0-CPU3)
Safety input	WS0-XTDI80202 (WS0-XTDI)* ² DB	Safety input: 8 points (single input); Spring-clamp terminal block
Safety I/O combined	WS0-XTIO84202 (WS0-XTIO)* ² DB	Safety input: 8 points (single input); Safety output: 4 points (single output); Output current: max. 2 A; Spring-clamp terminal block; Fast shut off function (response of 8 ms)
Safety relay output	WS0-4RO4002 (WS0-4RO)* ² DB	Safety output: safety relay output 4 points; Switching current: max. 6 A
USB/RS-232 conversion cable	WS0-C20M8U DB	USB/RS-232 conversion cable for PC-CPU connection (2 m)
RS-232 cable connecting to CPU	WS0-C20R2 DB	RS-232 cable for PC-CPU connection (2 m)
CC-Link interface	WS0-GCC100202 (WS0-GCC1)* ² DB	For CC-Link communication (general communication); Remote device station; CC-Link version 1.10
Ethernet interface	WS0-GETH00200 (WS0-GETH)* ² DB	For Ethernet TCP/IP connection (general communication)
Screw-in replacement terminal block	WS0-TBS4 DB	Screw-in replacement terminal block (4 pcs)
Spring-clamp replacement terminal block	WS0-TBC4 DB	Spring-clamp replacement terminal block (4 pcs)
Setting and Monitoring Tool	SW1DNN-WS0ADR-B* ³	Setting and monitoring tool for safety controller

*1. General specifications and product guarantee conditions for co-branded products may vary from those of general MELSEC products.

For more information, please refer to the relevant product manuals or contact your local Mitsubishi Electric sales office or representative.

*2. Abbreviated product model name is shown in () for this catalog. Please notify the full model name in the upper product list when contacting local Mitsubishi sales office or representative.

*3. For details on how to obtain the tool, please contact your local Mitsubishi Electric sales office or representative.

Safety extension modules MELSEC iQ-F Series

DB : Co-branded product*1

Item	Model	Outline
Safety main	FX5-SF-MU4T5 DB	Built-in program 9 types; Safety input: 4 points (single input); Safety output: 4 points (single output); Off delay time: 0/0.5/1/1.5/2/2.5/3/3.5/4/5 s; Spring-clamp terminal block
Safety input expansion	FX5-SF-8DI4*2 DB	Built-in program 9 types*3; Safety input: 8 points (single input); Off delay time*4: 0/0.5/1/1.5/2/2.5/3/3.5/4/5 s; Spring-clamp terminal block

- *1. General specifications and product guarantee conditions for co-branded products may vary from those of general MELSEC products.
For more information, please refer to the relevant product manuals or contact your local Mitsubishi Electric sales office or representative.
- *2. A safety main module is required to use.
- *3. For built-in program, logic pass connecting method with the safety main module can be set for INPUT A and INPUT B each.
- *4. Off delay time is set from the safety main module.

Edgecross is a registered trademark of the Edgecross Consortium.
CIP Safety is a trademark of ODVA, Inc.
Windows is registered trademarks of Microsoft Corporation in the United States and other countries.
OPC UA logo is registered trademarks of OPC Foundation.
QR Code is a trademark or a registered trademark of DENSO WAVE INCORPORATED in JAPAN, the United States and/or other countries.
All other company names and product names used in this document are trademarks or registered trademarks of their respective companies.

Precautions before use

This publication explains the typical features and functions of the products herein and does not provide restrictions or other information related to usage and module combinations. Before using the products, always read the product user manuals. Mitsubishi Electric will not be held liable for damage caused by factors found not to be the cause of Mitsubishi Electric; opportunity loss or lost profits caused by faults in Mitsubishi Electric products; damage, secondary damage, or accident compensation, whether foreseeable or not, caused by special factors; damage to products other than Mitsubishi Electric products; or any other duties.

For safe use

- To use the products given in this publication properly, always read the relevant manuals before beginning operation.
- The products have been manufactured as general-purpose parts for general industries, and are not designed or manufactured to be incorporated in a device or system used in purposes related to human life.
- Before using the products for special purposes such as nuclear power, electric power, aerospace, medicine or passenger-carrying vehicles, consult with Mitsubishi Electric.
- The products have been manufactured under strict quality control. However, when installing the products where major accidents or losses could occur if the products fail, install appropriate backup or fail-safe functions in the system.

Creating Solutions Together.



Low-voltage Power Distribution Products



Transformers, Med-voltage Distribution Products



Power Monitoring and Energy Saving Products



Power (UPS) and Environmental Products



Compact and Modular Controllers



Servos, Motors and Inverters



Visualization: HMIs



Edge Computing Products



Numerical Control (NC)



Collaborative and Industrial Robots

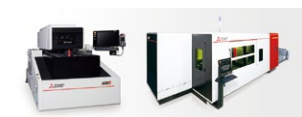

Processing machines: EDM, Lasers



SCADA, analytics and simulation software

Mitsubishi Electric's product lineup, from various controllers and drives to energy-saving devices and processing machines, all help you to automate your world. They are underpinned by software, innovative data monitoring, and modelling systems supported by advanced industrial networking and Edgecross IT/OT connectivity. Together with a worldwide partner ecosystem, Mitsubishi Electric factory automation (FA) has everything to make IoT and Digital Manufacturing a reality.

With a complete portfolio and comprehensive capabilities that combine synergies with diverse business units, Mitsubishi Electric provides a one-stop approach to how companies can tackle the shift to clean energy and energy conservation, carbon neutrality and sustainability, which are now a universal requirement of factories, buildings, and social infrastructure.

We at Mitsubishi Electric FA are your solution partners waiting to work with you as you take a step toward the realization of sustainable manufacturing and society through the application of automation. Let's automate the world together!

Country/Region, Sales office, Tel/Fax

<p>USA mitsubishi electric automation, inc. 500 Corporate Woods Parkway, Vernon Hills, IL 60061, U.S.A. Tel :+1-847-478-2100 Fax:+1-847-478-2253</p>	<p>Mexico MITSUBISHI ELECTRIC AUTOMATION, INC. Mexico Branch Boulevard Miguel de Cervantes Saavedra 301, Torre Norte Piso 5, Int. 502, Ampliacion Granada, Miguel Hidalgo, Ciudad de Mexico, Mexico, C.P.11520 Tel :+52-55-3067-7500</p>	<p>Brazil MITSUBISHI ELECTRIC DO BRASIL COMERCIO E SERVICOS LTDA. Avenida Adelino Cardana, 293, 21 andar, Bethaville, Barueri SP, Brasil Tel :+55-11-4689-3000 Fax:+55-11-4689-3016</p>
<p>Germany MITSUBISHI ELECTRIC EUROPE B.V. German Branch Mitsubishi-Electric-Platz 1, 40882 Ratingen, Germany Tel :+49-2102-486-0 Fax:+49-2102-486-7780</p>	<p>UK MITSUBISHI ELECTRIC EUROPE B.V. UK Branch Travellers Lane, UK-Hatfield, Hertfordshire, AL10 8XB, U.K. Tel :+44-1707-28-8780 Fax:+44-1707-27-8695</p>	<p>Ireland MITSUBISHI ELECTRIC EUROPE B.V. Irish Branch Westgate Business Park, Ballymount, Dublin 24, Ireland Tel :+353-1-4198800 Fax:+353-1-4198890</p>
<p>Italy MITSUBISHI ELECTRIC EUROPE B.V. Italian Branch Campus, Energy Park Via Energy Park 14, Vimercate 20871 (MB) Italy Tel :+39-039-60531 Fax:+39-039-6053-312</p>	<p>Spain MITSUBISHI ELECTRIC EUROPE, B.V. Spanish Branch Carretera de Rubi, 76-80-Appdo. 420, E-08190 Sant Cugat del Valles (Barcelona), Spain Tel :+34-935-65-3131 Fax:+34-935-89-1579</p>	<p>France MITSUBISHI ELECTRIC EUROPE B.V. French Branch 25, Boulevard des Bouvets, 92741 Nanterre Cedex, France Tel :+33-1-55-68-55-68 Fax:+33-1-55-68-57-57</p>
<p>Czech Republic MITSUBISHI ELECTRIC EUROPE B.V. Czech Branch Pekarska 621/7, 155 00 Praha 5, Czech Republic Tel :+420-734-402-587</p>	<p>Poland MITSUBISHI ELECTRIC EUROPE B.V. Polish Branch ul. Krakowska 48, 32-083 Balice, Poland Tel :+48-12-347-65-00</p>	<p>Sweden MITSUBISHI ELECTRIC EUROPE B.V. (Scandinavia) Hedvig Mollersgata 6, 223 55 Lund, Sweden Tel :+46-8-625-10-00 Fax:+46-46-39-70-18</p>
<p>Turkey MITSUBISHI ELECTRIC TURKEY ELEKTRIK URUNLERI A.S. Serifali Mahallesi Kale Sokak No:41 Umraniye / Istanbul Tel :+90-216-969-2500 Fax:+90-216-661-4447</p>	<p>UAE MITSUBISHI ELECTRIC EUROPE B.V. Dubai Branch Dubai Silicon Oasis, P.O.BOX 341241, Dubai, U.A.E. Tel :+971-4-3724716 Fax:+971-4-3724721</p>	<p>South Africa ADROIT TECHNOLOGIES 20 Waterford Office Park, 189 Witkoppen Road, Fourways, South Africa Tel :+27-11-658-8100 Fax:+27-11-658-8101</p>
<p>China MITSUBISHI ELECTRIC AUTOMATION (CHINA) LTD. Mitsubishi Electric Automation Center, No.1386 Hongqiao Road, Shanghai, China Tel :+86-21-2322-3030 Fax:+86-21-2322-3000</p>	<p>Taiwan SETSUYO ENTERPRISE CO., LTD. 6F, No.105, Wugong 3rd Road, Wugu District, New Taipei City 24889, Taiwan Tel :+886-2-2299-2499 Fax:+886-2-2299-2509</p>	<p>Korea MITSUBISHI ELECTRIC AUTOMATION KOREA CO., LTD. 7F to 9F, Gangseo Hangang Xi-tower A, 401, Yangcheon-ro, Gangseo-Gu, Seoul 07528, Korea Tel :+82-2-3660-9569 Fax:+82-2-3664-8372</p>
<p>Singapore MITSUBISHI ELECTRIC ASIA PTE. LTD. 307 Alexandra Road, Mitsubishi Electric Building, Singapore 159943 Tel :+65-6473-2308 Fax:+65-6476-7439</p>	<p>Thailand MITSUBISHI ELECTRIC FACTORY AUTOMATION (THAILAND) CO., LTD. 101, True Digital Park Office, 5th Floor, Sukhumvit Road, Bang Chak, Prakanong, Bangkok, Thailand Tel :+66-2682-6522-31 Fax:+66-2682-6020</p>	<p>Vietnam MITSUBISHI ELECTRIC VIETNAM COMPANY LIMITED 11th & 12th Floor, Viettel Tower B, 285 Cach Mang Thang 8 Street, Ward 12, District 10, Ho Chi Minh City, Vietnam. Tel :+84-28-3910-5945 Fax:+84-28-3910-5947</p>
<p>Indonesia PT. MITSUBISHI ELECTRIC INDONESIA Gedung Jaya 8th Floor, JL. MH. Thamrin No.12, Jakarta Pusat 10340, Indonesia Tel :+62-21-31926461 Fax:+62-21-31923942</p>	<p>India MITSUBISHI ELECTRIC INDIA PVT. LTD. Pune Branch Emerald House, EL-3, J Block, M.I.D.C., Bhosari, Pune-411026, Maharashtra, India Tel :+91-20-2710-2000 Fax:+91-20-2710-2100</p>	<p>Australia MITSUBISHI ELECTRIC AUSTRALIA PTY. LTD. 348 Victoria Road, P.O. Box 11, Rydalmere, N.S.W 2116, Australia Tel :+61-2-9684-7777 Fax:+61-2-9684-7245</p>



Mitsubishi Electric's e-F@ctory concept utilizes both FA and IT technologies, to reduce the total cost of development, production and maintenance, with the aim of achieving manufacturing that is a "step ahead of the times". It is supported by the e-F@ctory Alliance Partners covering software, devices, and system integration, creating the optimal e-F@ctory architecture to meet the end users needs and investment plans.



MITSUBISHI ELECTRIC CORPORATION
 HEAD OFFICE: TOKYO BLDG., 2-7-3, MARUNOUCHI, CHIYODA-KU, TOKYO 100-8310, JAPAN