

MITSUBISHI

Mitsubishi Safety Programmable Logic Controller

MELSEC **QS** series

QSCPU CPU Module

User's Manual
(Hardware)

QS001CPU

Thank you for purchasing the Mitsubishi safety programmable logic controller MELSEC-QS Series.

Prior to use, please read both this manual and detailed manual thoroughly and familiarize yourself with the product.

MODEL	QSCPU-U-HW-E
MODEL CODE	13JR91
IB(NA)-0800340ENG-C(0706)MEE	

● SAFETY PRECAUTIONS ●

(Always read these instructions before using this equipment.)

Before using the product, please read this manual, the relevant manuals introduced in this manual, standard PLC manuals, and the safety standard carefully and pay full attention to safety to handle the product correctly. In this manual, the safety instructions are ranked as "DANGER" and "CAUTION".



DANGER

Indicates that incorrect handling may cause hazardous conditions, resulting in death or severe injury.



CAUTION

Indicates that incorrect handling may cause hazardous conditions, resulting in medium or slight personal injury or physical damage.

Note that the  **CAUTION** level may lead to a serious consequence according to the circumstances.

Always follow the instructions of both levels because they are important to personal safety.

Please save this manual to make it accessible when required and always forward it to the end user.

[Design Precautions]

DANGER

- When a safety PLC detects an error in an external power supply or a failure in PLC main module, it turns off all the outputs. Create an external circuit to securely stop the power of hazard by turning off the outputs. Incorrect configuration may result in an accident.
- Create short current protection for a safety relay, and a protection circuit such as a fuse, and breaker, outside a safety PLC.
- When data/program change, or status control is performed from a PC to a running safety PLC, create an interlock circuit outside the sequence program and safety PLC to ensure that the whole system always operates safely. For the operations to a safety PLC, pay full attention to safety by reading the relevant manuals carefully, and establishing the operating procedure. Furthermore, for the online operations performed from a PC to a safety CPU module, the corrective actions against a communication error due to a cable connection fault, etc. should be predetermined as a system.
- All output signals from a safety CPU module to the CC-Link Safety system master module are prohibited to use. These signals can be found in the CC-Link Safety System Master Module User's Manual. Do not turn ON or OFF these signals by sequence program, since turning ON/OFF these output signals of the PLC system may cause malfunctions and safety operation cannot be guaranteed.
- When a safety remote I/O module has detected CC-Link Safety error, it turns off all the outputs. Note that the outputs in a sequence program are not automatically turned off. If CC-Link Safety error has been detected, create a sequence program that turns off the outputs in the program. If the CC-Link Safety is restored with the outputs on, it may suddenly operate and result in an accident.
- To inhibit restart without manual operation after safety function was performed and outputs were turned OFF, create an interlock program which uses a reset button for restart.

CAUTION

- Do not bunch the wires of external devices or communication cables together with the main circuit or power lines, or install them close to each other. They should be installed 100 mm (3.94 inch) or more from each other. Not doing so could result in noise that would cause malfunctions.

[Installation Precautions]

CAUTION

- Use a safety PLC in the environment that meets the general specifications described in this manual.
Using this PLC in an environment outside the range of the general specifications could result in electric shock, fire, erroneous operation, and damage to or deterioration of the product.
- While pressing the installation lever located at the bottom of module, insert the module fixing tab into the fixing hole in the base unit until it stops. Then, securely mount the module with the fixing hole as a supporting point.
Incorrect loading of the module can cause a failure or drop.
Secure the module to the base unit with screws.
Tighten the screw in the specified torque range.
If the screws are too loose, it may cause a drop of the screw or module.
Over tightening may cause a drop due to the damage of the screw or module.
- Completely turn off the external supply power used in the system before mounting or removing the module.
Not doing so could result in damage to the product.
- Do not directly touch the module's conductive parts or electronic components.
Doing so may cause malfunctions or a failure.

[Wiring Precautions]

DANGER

- Be sure to shut off all phases of the external supply power used by the system before wiring.
Not completely turning off all power could result in electric shock or damage to the product.
- When energizing or operating the module after installation or wiring, be sure to close the attached terminal cover.
Not doing so may result in electric shock.

[Wiring Precautions]

CAUTION

- Ground the FG and LG terminals correctly.
Not doing so could result in electric shock or malfunctions.
- Use a solderless terminal with insulation sleeve for wiring of a terminal block.
Use up to two solderless terminals for a single terminal.
- Use applicable solderless terminals and tighten them with the specified torque.
If any solderless spade terminal is used, it may be disconnected when the terminal screw comes loose, resulting in a failure.
- Wire the module correctly after confirming the rated voltage and terminal layout.
Connecting a power supply of a different rated voltage or incorrect wiring may cause a fire or failure.
- Tighten a terminal block mounting screw, terminal screw, and module mounting screw within the specified torque range.
If the terminal block mounting screw or terminal screw is too loose, it may cause a short circuit, fire, or malfunctions.
If too tight, it may damage the screw and/or the module, resulting in a drop of the screw or module, a short circuit or malfunctions.
If the module mounting screw is too loose, it may cause a drop of the screw or module.
Over tightening the screw may cause a drop due to the damage of the screw or module.
- Be sure there are no foreign substances such as sawdust or wiring debris inside the module. Such debris could cause a fire, failure, or malfunctions.
- The module has an ingress prevention label on its top to prevent foreign matter, such as wire offcuts, from entering the module during wiring.
Do not peel this label during wiring. Before starting system operation, be sure to peel this label because of heat dissipation.
- Install our PLC in a control panel for use.
Wire the main power supply to the power supply module installed in a control panel through a distribution terminal block.
Furthermore, the wiring and replacement of a power supply module have to be performed by a maintenance worker who acquainted with shock protection. (For the wiring methods, refer to the QSCPU User's Manual (Hardware Design, Maintenance and Inspection).)

[Startup and Maintenance precautions]



DANGER

- Do not touch the terminals while power is on.
Doing so could result in electric shock.
- Correctly connect the battery. Also, do not charge, disassemble, heat, place in fire, short circuit, or solder the battery.
Mishandling of battery can cause overheating, cracks, or ignition which could result in injury and fires.
- Turn off all phases of the external supply power used in the system when cleaning the module or retightening the terminal block mounting screws, terminal screws, or module mounting screws.
Not doing so could result in electric shock. Tighten a terminal block mounting screw, terminal screw, and module mounting screw within the specified torque range.
If the terminal block mounting screw or terminal screw is too loose, it may cause a short circuit, fire, or malfunctions.
If too tight, it may damage the screw and/or the module, resulting in a drop of the screw or module, a short circuit or malfunctions.
If the module mounting screw is too loose, it may cause a drop of the screw or module.
Over tightening the screw may cause a drop due to the damage of the screw or module.

[Startup and Maintenance precautions]

CAUTION

- The online operations performed from a PC to a running safety PLC (Program change when a safety CPU is RUN, device test, and operating status change such as RUN-STOP switching) have to be executed after the manual has been carefully read and the safety has been ensured.
Following the operating procedure predetermined at designing, the operation has to be performed by an instructed person.
When changing a program while a safety CPU is RUN (Write during RUN), it may cause a program breakdown in some operating conditions.
Fully understand the precautions described in the GX Developer's manual before use.
- Do not disassemble or modify the modules.
Doing so could cause a failure, malfunctions, injury, or fire.
If the product is repaired or remodeled by other than the specified FA centers or us, the warranty is not covered.
- Use any radio communication device such as a cellular phone or a PHS phone more than 25cm (9.85 inch) away in all directions of safety PLC.
Not doing so can cause malfunctions.
- Completely turn off the external supply power used in the system before mounting or removing the module.
Not doing so may result in a failure or malfunctions of the module.
- Restrict the mounting/removal of a module, base unit, and terminal block up to 50 times (IEC61131-2-compliant), after the first use of the product.
Failure to do so may cause the module to malfunction due to poor contact of connector.
- Do not drop or give an impact to the battery mounted to the module.
Doing so may damage the battery, causing the battery fluid to leak inside the battery.
If the battery is dropped or given an impact, dispose of it without using.
- Before touching the module, always touch grounded metal, etc. to discharge static electricity from human body, etc.
Not doing so may result in a failure or malfunctions of the module.

[Disposal Precautions]



CAUTION

- When disposing of this product, treat it as industrial waste.

[Transportation Precautions]



CAUTION

- When transporting lithium batteries, make sure to treat them based on the transport regulations.
(For details of the controlled models, refer to Chapter 6.)

Revisions

* The manual number is noted at the lower right of the top cover.

Print Date	*Manual Number	Revision
Sep., 2006	IB(NA)-0800340ENG-A	First edition
Oct., 2006	IB(NA)-0800340ENG-B	Correction MODEL CODE
Jun., 2007	IB(NA)-0800340ENG-C	Correction Section 2.2, 2.3, 2.4, 3.1.3, 4.2

Japanese Manual Version IB(NA)-0800339-B

This manual confers no industrial property rights or any rights of any other kind, nor does it confer any patent licenses. Mitsubishi electric Corporation cannot be held responsible for any problems involving industrial property rights which may occur as a result of using the contents noted in this manual.

CONTENTS

1. OVERVIEW	1
1.1 Included Parts	1
1.2 Confirming Serial No. and Function Version	2
2. SPECIFICATIONS	3
2.1 General Specifications	3
2.2 Performance Specifications of CPU Modules	5
2.3 Power supply module specifications	7
2.4 Specifications of Base Units	10
3. EMC AND LOW VOLTAGE DIRECTIVES	11
3.1 Requirements for Conformance to EMC Directive	11
3.1.1 Standards relevant to the EMC Directive	12
3.1.2 Installation instructions for EMC Directive	13
3.1.3 Cables	14
3.1.4 Power Supply Module	16
3.1.5 Others	16
3.2 Requirement to Conform to the Low Voltage Directive	18
3.2.1 Standard applied for MELSEC-QS series PLC	18
3.2.2 MELSEC-QS series PLC selection	18
3.2.3 Power supply	19
3.2.4 Control panel	19
3.2.5 Grounding	20
3.2.6 External wiring	21
4. LOADING AND INSTALLATION	22
4.1 Module Installation	23
4.1.1 Handling instructions	23
4.1.2 Instructions for mounting the base unit	24
4.1.3 Installation and removal of module	33
4.2 Power Supply Wiring	36
4.2.1 Precaution when connecting the uninterruptive power supply	40
4.3 Part Names and Settings of QS001CPU	41
4.3.1 Part names and settings	41
4.3.2 Switch Operation after Writing a Program	44
4.3.3 Reset Operation	45
4.3.4 Part Names of Power Supply Modules	47

4.3.5 Part Names of Base unit	49
5. ERROR CODES	50
5.1 Reading an error code	50
6. TRANSPORTATION PRECAUTIONS	51
6.1 Controlled Models	51
6.2 Transport Guidelines	51

About Manual

Introduction Manual

Before constructing or designing the safety-related system, be sure to read the following manual.

Manual name	Manual No. (Model code)
Safety Application Guide Explains the overview and construction method of the safety-related system, laying and wiring examples, application programs, etc. (Sold separately)	SH-080613ENG (13JR90)

The following manuals are also related to this product.

If necessary, order them by quoting the details in the tables below.

Detailed Manual

Manual name	Manual No. (Model code)
QSCPU User's Manual (Hardware Design, Maintenance and Inspection) Explains the specifications of the QSCPU, safety power supply module, safety base unit, etc. (Sold separately)	SH-080626ENG (13JR92)
QSCPU User's Manual (Function Explanation, Program Fundamentals) Explains the functions, programming methods, devices, etc. that are necessary to create programs with the QSCPU. (Sold separately)	SH-080627ENG (13JR93)

Relevant Manual

Manual name	Manual No. (Model code)
QSCPU Programming Manual (Common Instructions) Explains how to use the sequence instructions and application instructions. (Sold separately)	SH-080628ENG (13JW01)

1. OVERVIEW

This manual describes the performance specifications, loading and installation, part names and settings of MELSEC-QS series CPU modules, and how to read error codes.

1.1 Included Parts

The following tables list the parts included with the corresponding modules.

(1) Safety CPU module

Product Name	Type	Quantity
Safety CPU module	QS001CPU	1
Battery	Q6BAT	1

(2) Safety main base unit for QS series

Product Name	Type	Quantity
Safety main base unit	QS034B	1
Base unit mounting screw	M4 × 14 screw	4
This manual	-	1

(3) Safety power supply module

Product Name	Type	Quantity
Safety power supply module	QS061P-A1	1
	QS061P-A2	

1.2 Confirming Serial No. and Function Version

The serial No. and function version of the QSCPU can be confirmed on the rated plate and GX Developer's system monitor.

(1) Confirming the serial No. on the rated plate

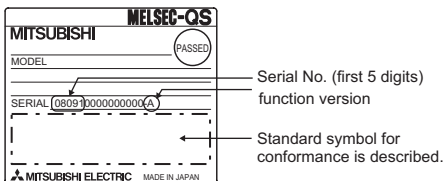

(2) Confirmation on the system monitor

The QSCPU serial No. and function version can be confirmed with Product Information List on the GX Developer's system monitor.*

The intelligent function module's serial No. and function version can also be confirmed.

Serial number Function version

Slot	Type	Series	Model name	Points	I/O No.	Master PLC	Serial No.	Ver.
PLC	PLC	Q5	Q5001CPU	-	-	-	08091000000000	A
0-0	Intelli.	Q5	Q50J61BT12	32pt	0000	-	08091000000000	A
0-1	-	-	None	-	-	-	-	-
0-2	-	-	None	-	-	-	-	-
0-3	-	-	None	-	-	-	-	-

CSV file creating Close

POINT

The serial No. described on the rated plate may not match with the serial No. displayed on the product information of GX Developer.

- The serial No. on the rated plate describes the management information of the product.
- The serial No. displayed on the product information of GX Developer describes the function information of the product. The function information of the product is updated when adding functions.

2. SPECIFICATIONS

2.1 General Specifications

The performance specifications of QS series PLC are shown in Table 2.1.

Table 2.1 General Specifications

Item	Specifications					
Operating ambient temperature	0 to 55°C					
Storage ambient temperature	-40 to 75°C					
Operating ambient humidity	5 to 95%RH, non-condensing					
Storage ambient humidity	5 to 95%RH, non-condensing					
Vibration resistance	Conforming to JIS B 3502, IEC 61131-2		Frequency range	Constant acceleration	Half amplitude	Sweep count
		Under intermittent vibration	5 to 9Hz	----	3.5mm (0.14inch)	10 times each in X, Y, Z directions
			9 to 150Hz	9.8m/s ²	----	
		Under continuous vibration	5 to 9Hz	----	1.75mm (0.07inch)	
9 to 150Hz	4.9m/s ²		----			
Shock resistance	Conforming to JIS B 3502, IEC 61131-2 (147 m/s ² , duration of action 11ms, three times in X, Y, Z directions respectively by sine half-wave pulse)					
Operating ambience	No corrosive gases					
Operating altitude ^{*3}	2000m (6562ft.) max.					
Installation location	Inside control panel					
Overvoltage category ^{*1}	II max.					
Pollution level ^{*2}	2 max.					
Equipment category	Class I					

- *1: This indicates the section of the power supply to which the equipment is assumed to be connected between the public electrical power distribution network and the machinery within premises. Category II applies to equipment for which electrical power is supplied from fixed facilities.
The surge voltage withstand level for up to the rated voltage of 300 V is 2500 V.
- *2: This index indicates the degree to which conductive material is generated in terms of the environment in which the equipment is used.
Pollution level 2 is when only non-conductive pollution occurs. A temporary conductivity caused by condensing must be expected occasionally.
- *3: Do not use or store the PLC under pressure higher than the atmospheric pressure of altitude 0m.
Doing so can cause a malfunction.
When using the PLC under pressure, please contact your sales representative.

2.2 Performance Specifications of CPU Modules

This section provides the performance specifications of the CPU modules.

Table 2.2 QS001CPU Performance Specifications

Item		Type	Remarks
		QS001CPU	
Control method		Repeated operation using stored program	-
I/O control mode		Refresh mode	-
Programming language (Language dedicated to sequence control)		Relay symbol language, Function block	-
Processing speed (sequence instruction)	LD X0	0.10 μ s	-
	MOV D0 D1	0.35 μ s	-
Constant scan (Function for keeping regular scan time)		1 to 2000ms (Setting available in1ms unit.)	Setting by parameters.
Program capacity ^{*1}		14k steps (56k bytes)	-
Memory capacity ^{*1}	Program memory (drive 0)	128k bytes	-
	Standard ROM (drive 4)	128k bytes	-
Max. number of files stored	Program memory	3 ^{*2}	-
	Standard ROM	3 ^{*2}	-
No. of times of writing data into the standard ROM		Max.100000 times	-
No. of I/O device points		6144 points(X/Y0 to 17FF)	No. of points usable on program
No. of I/O points		1024 points(X/Y0 to 3FF)	No. of points accessible to the actual I/O module
Number of loadable modules		4	-
Available battery		Q6BAT	-
Clock function		Year, month, day, hour, minute, second, day of week (Automatic leap year judgment) Accuracy -3.18 to +5.25s (TYP. +2.14s)/d at 0°C -3.18 to +2.59s (TYP. +2.07s)/d at 25°C -12.97 to +3.63s (TYP. -3.16s)/d at 55°C	-

Table 2.2 QS001CPU Performance Specifications

Item	Type		Remarks
	QS001CPU		
Allowable instantaneous power failure period	Varies depending on the power supply module.		-
5VDC internal current consumption	0.43A		-
External dimensions	H	98mm (3.86inch)	-
	W	55.2mm (2.17inch)	-
	D	113.8mm (4.48inch)	-
Weight	0.29kg		-
Protection of degree	IP2X		-

*1: The maximum number of executable sequence steps is as shown below.(Program capacity) - (File head size (default: 34 steps))
For the details, refer to the manual below.

- QSCPU User's Manual (Function Explanation, Program Fundamentals)

*2: Each of parameter, sequence program, SFC program, and device comment files can be stored.

2.3 Power supply module specifications

This section provides the specifications of the power supply modules.

Table 2.3 QS061P-A1/A2 Performance Specification

Item	Performance Specifications	
	QS061P-A1	QS061P-A2
Base loading position	QS series power supply module loading slot	
Applicable base unit	QS034B	
Input power supply	100 to 120VAC ^{+10%} _{-15%} (85 to 132VAC)	200 to 240VAC ^{+10%} _{-15%} (170 to 264VAC)
Input frequency	50/60Hz \pm 5%	
Input voltage distortion factor	Within 5% (See section 4.2.1)	
Max. input apparent power	125VA	
Inrush current	20A within 8ms ⁴	
Rated output current	5VDC	6A
Overcurrent protection ¹	5VDC	6.6A or more
Overvoltage protection ²	5VDC	5.5 to 6.5V
Efficiency	70% or more	
Allowable momentary power failure period ³	Within 20ms	
Dielectric withstand voltage	Across inputs/LG and outputs/FG 1780VAC rms/3 cycles (2000 m (6562 ft.))	Across inputs/LG and outputs/FG 2830VAC rms/3 cycles (2000 m (6562 ft.))
Insulation resistance	Across inputs/LG and outputs/FG, across inputs and LG, across outputs and FG 10M Ω or more by insulation resistance tester	
Noise durability	<ul style="list-style-type: none"> By noise simulator of 1500Vp-p noise voltage, 1 μs noise width and 25 to 60Hz noise frequency Noise voltage IEC61000-4-4, 2kV 	
Operation indication	LED indication (Normal: ON (green), Error: OFF)	
Fuse	Built-in (Unchangeable by user)	

Table 2.3 QS061P-A1/A2 Performance Specification

Item		Performance Specifications	
		QS061P-A1	QS061P-A2
Contact output section	Application	ERR. contact (See section 4.3.4)	
	Rated switching voltage, current	24VDC, 0.5A	
	Minimum switching load	5VDC, 1mA	
	Response time	OFF to ON: 10ms max. ON to OFF: 12ms max.	
	Life	Mechanica: More than 20 million times Electrical : More than 100 thousand times at rated switching voltage, current	
	Surge suppressor	No	
	Fuse	No	
Terminal screw size		M3.5 screw	
Applicable wire size		0.75 to 2mm ²	
Applicable solderless terminal		RAV1.25 to 3.5, RAV2 to 3.5 (0.8mm or less thick)	
Applicable tightening torque		0.66 to 0.89N•m	
External dimensions	H	98mm (3.86inch)	
	W	55.2mm (2.17inch)	
	D	115mm (4.53inch)	
Weight		0.40kg	

POINT

***1:Overcurrent protection**

The overcurrent protection function shuts off the 5 VDC circuit and stops the system if the current flowing in the circuit exceeds the specified value.

The LED of the power supply module is turned off or lights up in dim green when voltage is lowered. If this device is activated, switch the input power supply off and eliminate the cause such as insufficient current capacity or short. Then, a few minutes later, switch it on to restart the system.

The initial start for the system takes place when the current value becomes normal.

***2:Overvoltage protection**

The overvoltage protection function shuts off the 5 VDC circuit and stops the system if a voltage of 5.5 VDC or above is applied to the circuit.

When this device is activated, the power supply module LED is switched OFF.

For restart of the system, turn off the input power supply, and then turn on in a few minutes. This allows the system to start up with initial start. If the system does not start up and a LED indication remains off, replacement of a power supply module is required.

***3:Allowable momentary power failure period**

- An instantaneous power failure lasting less than 20ms will cause AC down to be detected, but operation will continue.
- An instantaneous power failure lasting in excess of 20ms may cause the operation to continue or initial start to take place depending on the power supply load.

***4:Inrush current**

When power is switched on again immediately (within 5 seconds) after power-off, an inrush current of more than the specified value (2ms or less) may flow. Reapply power 5 or more seconds after power-off. When selecting a fuse and breaker in the external circuit, take account of the blowout, detection characteristics and above matters.

2.4 Specifications of Base Units

This section provides the specification of base units.

(1) Base unit

Type	Item	QS034B
Number of I/O modules installed		4
Applicable module		QS series modules
5 VDC internal current consumption		0.1A
Weight		0.28kg
External dimensions	H	98mm (3.86inch)
	W	245mm (9.65inch)
	D	44.1mm (1.74inch)

3. EMC AND LOW VOLTAGE DIRECTIVES

For the products sold in European countries, the conformance to the EMC Directive, which is one of the European directives, has been a legal obligation since 1996. Also, conformance to the Low Voltage Directive, another European Directive, has been a legal obligation since 1997.

Manufacturers who recognize their products must conform to the EMC and Low Voltage Directives are required to declare that their products conform to these Directives and put a "CE mark" on their products.

3.1 Requirements for Conformance to EMC Directive

The EMC Directive specifies that products placed on the market must "be so constructed that they do not cause excessive electromagnetic interference (emissions) and are not unduly affected by electromagnetic interference (immunity)".

The applicable products are requested to meet these requirements. The Section 3.1.1 through Section 3.1.5 summarize the precautions on conformance to the EMC Directive of the machinery constructed using the MELSEC-QS series PLCs.

The details of these precautions has been prepared based on the control requirements and the applicable standards control. However, we will not assure that the overall machinery manufactured according to these details conforms to the above-mentioned directives. The method of conformance to the EMC Directive and the judgment on whether or not the machinery conforms to the EMC Directive must be determined finally by the manufacturer of the machinery.

3.1.1 Standards relevant to the EMC Directive

The standards relevant to the EMC Directive are listed below.

Specification	Test Item	Test Details	Standard Value
EN61131-2: 2003	EN55011 (CISPR11) Radiated emission *2	Radio waves from the product are measured.	30M-230MHz QP: 40dB μ V/m (10m (32.81 ft.) in measurement range) *1 230M-1000MHz QP: 47dB μ V/m(10m (32.81 ft.) in measurement range)
	EN55011 (CISPR11) Conducted emission	Noise from the product to the power line is measured.	150k-500kHz QP: 79dB Mean : 66dB *1 500k-30MHz QP : 73dB Mean : 60dB
	EN61000-4-2 Electrostatic discharge immunity*2	Immunity test in which electrostatic is applied to the cabinet of the equipment.	8kV Air discharge 4kV Contact discharge
	EN61000-4-3 Radiated electromagnetic field immunity*2	Immunity test in which electric fields are irradiated to the product.	1.4GHz-2.0GHz, 80-1000MHz, 10V/m, 80%AM modulation 1kHz
	EN61000-4-8 Power frequency magnetic field immunity*2	Immunity test in which the product is installed in the magnetic field of the induction coil.	50Hz/60Hz, 30A/m
	EN61000-4-4 Electrical fast transient/ burst immunity *2	Immunity test in which burst noise is applied to the power cable and signal line.	AC power cable: \pm 2kV DC power cable: \pm 2kV DC I/O, analog, communication line: \pm 1kV
	EN61000-4-5 Surge immunity *2	Immunity test in which lightning surge is applied to the power cable and signal line.	AC power cable: Common mode \pm 2kV, differential mode \pm 1kV DC power cable: Common mode \pm 1kV, differential mode \pm 0.5kV DC I/O, analog, communication (shielded): Common mode \pm 1kV DC I/O, analog (unshielded): Common mode \pm 0.5kV, differential mode \pm 0.5kV Communication (unshielded): \pm 1kV
	EN61000-4-6 Conducted disturbances immunity *2	Immunity test in which high frequency noise is applied to the power cable and signal line.	0.15-80MHz, 80%AM modulation 1kHz, 3Vrms

*1: QP : Quasi-peak value, Mean : Average value

*2: The PLC is an open type device (device installed to another device) and must be installed in a conductive control panel.

The tests for the corresponding items were performed while the PLC was installed inside a control panel.

3.1.2 Installation instructions for EMC Directive

The PLC is open equipment and must be installed within a control panel for use.*

This not only ensures safety but also ensures effective shielding of PLC-generated electromagnetic noise.

*: CC-Link Safety remote station should be used having the control panel installed.

(1) Control panel

- a) Use a conductive control panel.
- b) When attaching the control panel's top plate or base plate, mask painting and weld so that good surface contact can be made between the panel and plate.
- c) To ensure good electrical contact with the control panel, mask the paint on the installation bolts of the inner plate in the control panel so that contact between surfaces can be ensured over the widest possible area.
- d) Earth the control panel with a thick wire so that a low impedance connection to ground can be ensured even at high frequencies.
- e) Holes made in the control panel must be 10 cm (3.94 inch) diameter or less. If the holes are 10 cm (3.94 inch) or larger, radio frequency noise may be emitted.
In addition, because radio waves leak through a clearance between the control panel door and the main unit, reduce the clearance as much as practicable.
The leakage of radio waves can be suppressed by the direct application of an EMI gasket on the paint surface.
Our tests have been carried out on a panel having the damping characteristics of 37 dB max. and 30 dB mean (measured by 3 m method with 30 to 300 MHz).

- (2) Connection of power and earth wires
Earthing and power supply wires for the PLC system must be connected as described below.
- a) Provide an earthing point near the power supply module. Earth the power supply's LG and FG terminals (LG : Line Ground, FG : Frame Ground) with the thickest and shortest wire possible. (The wire length must be 30 cm (11.81 inch) or shorter.) The LG and FG terminals function is to pass the noise generated in the PLC system to the ground, so an impedance that is as low as possible must be ensured. As the wires are used to relieve the noise, the wire itself carries a large noise content and thus short wiring means that the wire is prevented from acting as an antenna.
 - b) The earth wire led from the earthing point must be twisted with the power supply wires. By twisting with the earthing wire, noise flowing from the power supply wires can be relieved to the earthing. However, if a filter is installed on the power supply wires, the wires and the earthing wire may not need to be twisted.

3.1.3 Cables

The cables extracted from the control panel contain a high frequency noise component. On the outside of the control panel, therefore, they serve as antennas to emit noise.

When pulling out cables which are connected to CC-Link Safety master module, MELSECNET/H module and CC-Link Safety remote I/O module, be sure to use shielded cables.

The use of a shielded cable also increases noise resistance. For signal lines (including common line) of CC-Link Safety master module, MELSECNET/H module and CC-Link Safety remote I/O module, by using shielded cables, noise durability satisfies the standard value. If a shielded cable is not used or not earthed correctly, the noise resistance will not meet the specified requirements.

- (1) Earthing of shielded of shield cable
 - a) Earth the shield of the shielded cable as near the unit as possible taking care so that the earthed cables are not induced electromagnetically by the cable to be earthed.

- b) Take appropriate measures so that the shield section of the shielded cable from which the outer cover was partly removed for exposure is earthed to the control panel on an increased contact surface. A clamp may also be used as shown in the figure below. In this case, however, apply a cover to the painted inner wall surface of the control panel which comes in contact with the clamp.

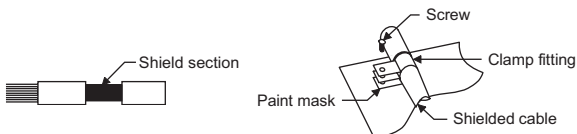

- Note) The method of earthing by soldering a wire onto the shield section of the shielded cable as shown below is not recommended. The high frequency impedance will increase and the shield will be ineffective.

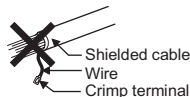

(2) MELSECNET/H module

Always use a double-shielded coaxial cable (MITSUBISHI CABLE INDUSTRIES, LTD.: 5C-2V-CCY) for the coaxial cables MELSECNET/H module. Radiated noise in the range of 30MHz or higher can be suppressed by use of the double-shielded coaxial cables. Earth the double-shielded coaxial cable by connecting its outer shield to the ground.

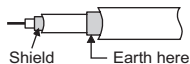

Refer to (1) for the earthing of the shield.

(3) I/O signal cables and other communication cables

For the I/O signal cables and other communication cables (such as CC-Link Safety), always ground the shields of the shield cables as in (1) if they are pulled out of the control panel.

3.1.4 Power Supply Module

Always ground the LG and FG terminals after short-circuiting them.

3.1.5 Others

(1) Ferrite core

A ferrite core has the effect of reducing conduction noise in around 10MHz band and radiated noise in the 30MHz to 100MHz band.

It is recommended to fit ferrite cores if shielded cables pulled out of the panel do not provide sufficient shielding effects or if the emission of conduction noise from the power supply line has to be suppressed.

It is also recommended to fit a ferrite core to the USB cable which connects the CPU and the personal computer as measures against noise.

Regarding the number of winding to the ferrite core, the more the better. The two turns or more is recommended as the number of winding.

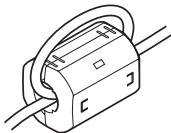

Note that the ferrite cores should be fitted to the cables in the position immediately before they are pulled out of the panel. If the fitting position is improper, the ferrite will not produce any effect.

(2) Noise filter (power supply line filter)

A noise filter is a component which has an effect on conducted noise.

It is not required to fit the noise filter to the power supply line, but fitting it can further suppress noise.

(The noise filter has the effect of reducing conducted noise of 10MHz or less.)

The precautions required when installing a noise filter are described below.

- a) Do not bundle the wires on the input side and output side of the noise filter. When they are bundled, the output side noise will induct into the input side wires.

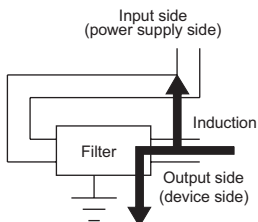

The noise will induct into input side when the input and output wires are bundled.

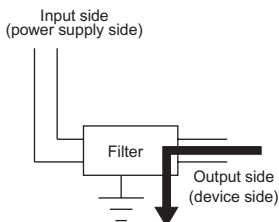

Separate the input and output wires.

- b) Earth the noise filter earthing terminal to the control panel with the short wire as possible (less than approx. 10 cm (3.94 inch)).

Reference

Noise Filter Model Name	FN343-3/01	FN660-6/06	ZHC2203-11
Manufacturer	SCHAFFNER	SCHAFFNER	TDK
Rated current	3A	6A	3A
Rated voltage	250V		

3.2 Requirement to Conform to the Low Voltage Directive

The Low Voltage Directive requires each device that operates with the power supply ranging from 50 to 1000VAC and 75 to 1500VDC to satisfy the safety requirements.

In Section 3.2.1 to Section 3.2.6, cautions on installation and wiring of the MELSEC-QS series PLC to conform to the Low Voltage Directive are described.

These descriptions are based on the requirements and standards of the regulation, however, it does not guarantee that the entire machinery manufactured based on the descriptions conforms to the above-mentioned directive. The method and judgment for the conformity to the low voltage directive must be left to the manufacturer's own discretion.

3.2.1 Standard applied for MELSEC-QS series PLC

The standard applied for MELSEC-QS series PLC is EN61131-2 safety of devices used in measurement rooms, control rooms, or laboratories.

The MELSEC-QS series PLC modules which operate at the rated voltage of 50VAC/75VDC or above are also developed to conform to the above standard.

The modules which operate at the rated voltage of less than 50VAC/75VDC are out of the Low Voltage Directive application range.

For products with the CE mark, refer to the "Standard Compliance" menu of the MELFANSweb homepage.

3.2.2 MELSEC-QS series PLC selection

(1) Power supply module

There are dangerous voltages (voltages higher than 42.4V peak) inside the power supply modules of the 100/200VAC rated input voltages. Therefore, the CE marked models are enhanced in insulation internally between the primary and secondary.

(2) CPU module, base unit

Using 5VDC circuits inside, the above modules are out of the Low Voltage Directive application range.

(3) CC-Link Safety master module, MELSECNET/H module

CC-Link Safety master module, and MELSECNET/H module are out of the scope of the low voltage directive because the rated voltage is 24VDC or less.

3.2.3 Power supply

The insulation specification of the power supply module was designed assuming installation category II. Be sure to use the installation category II power supply to the PLC.

The installation category indicates the durability level against surge voltage generated by a thunderbolt. Category I has the lowest durability; category IV has the highest durability.

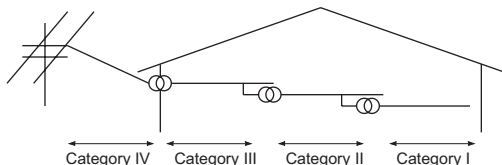

Figure 1: Installation category

Category II indicates a power supply whose voltage has been reduced by two or more levels of isolating transformers from the public power distribution.

3.2.4 Control panel

Because the PLC is an open device (a device designed to be stored within another module), be sure to use it after storing in the control panel.*

*: Also, each network remote station needs to be installed inside the control panel.

(1) Electrical shock prevention

The control panel must be handled as shown below to protect a person who does not have adequate knowledge of electricity from an electric shock.

- a) Lock the control panel so that only those who are trained and have acquired enough knowledge of electric facilities can open the control panel.
- b) The control panel must have a structure which automatically stops the power supply when the box is opened.
- c) For electric shock protection, use IP20 or greater control panel.

(2) Dustproof and waterproof features

The control panel also has the dustproof and waterproof functions. Insufficient dustproof and waterproof features lower the insulation withstand voltage, resulting in insulation destruction.

The insulation in our PLC is designed to cope with the pollution level 2, so use in an environment with pollution level 2 or below.

Pollution level 1: An environment where the air is dry and conductive dust does not exist.

Pollution level 2: An environment where conductive dust does not usually exist, but occasional temporary conductivity occurs due to the accumulated dust. Generally, this is the level for inside the control box equivalent to IP54 in a control room or on the floor of a typical factory.

Pollution level 3: An environment where conductive dust exists and conductivity may be generated due to the accumulated dust.

An environment for a typical factory floor.

Pollution level 4: Continuous conductivity may occur due to rain, snow, etc. An outdoor environment.

As shown above, the PLC can realize the pollution level 2 when stored in a control panel equivalent to IP54.

3.2.5 Grounding

There are the following two different grounding terminals.

Use either grounding terminal in an earthed status.

Protective grounding  : Maintains the electrical safety of the PLC and improves the noise resistance.

Functional grounding  : Improves the noise resistance.

3.2.6 External wiring

- (1) 24VDC external power supply
This power supply must include a reinforced insulation for 24VDC circuit to prevent dangerous voltage for CC-Link Safety remote I/O module.
- (2) External devices
When a device with a hazardous voltage circuit is externally connected to the PLC, use the device whose interface circuit section to the PLC has the reinforced insulation against the hazardous voltage circuit.
- (3) Reinforced insulation
Reinforced insulation refers to the insulation with the dielectric withstand voltage shown in Table 1.

Table 1: Reinforced Insulation Withstand Voltage
(Installation Category II, source : IEC664)

Rated voltage of hazardous voltage area	Surge withstand voltage (1.2/50 μ s)
150V AC or below	2500V
300V AC or below	4000V

4. LOADING AND INSTALLATION



DANGER

- When a safety PLC detects an error in an external power supply or a failure in PLC main module, it turns off all the outputs. Create an external circuit to securely stop the power of hazard by turning off the outputs. Incorrect configuration may result in an accident.
- Create short current protection for a safety relay, and a protection circuit such as a fuse, and breaker, outside a safety PLC.
- When data/program change, or status control is performed from a PC to a running safety PLC, create an interlock circuit outside the sequence program and safety PLC to ensure that the whole system always operates safely.
For the operations to a safety PLC, pay full attention to safety by reading the relevant manuals carefully, and establishing the operating procedure.
Furthermore, for the online operations performed from a PC to a safety CPU module, the corrective actions against a communication error due to a cable connection fault, etc. should be predetermined as a system.
- All output signals from a safety CPU module to the CC-Link Safety system master module are prohibited to use. These signals can be found in the CC-Link Safety System Master Module User's Manual. Do not turn ON or OFF these signals by sequence program, since turning ON/OFF these output signals of the PLC system may cause malfunctions and safety operation cannot be guaranteed.
- When a safety remote I/O module has detected a CC-Link Safety error, it turns off all the outputs. Note that the outputs in a sequence program are not automatically turned off. If a CC-Link Safety error has been detected, create a sequence program that turns off the outputs in the program. If the CC-Link Safety is restored with the outputs on, it may suddenly operate and result in an accident.
- To inhibit restart without manual operation after safety function was performed and outputs were turned OFF, create an interlock program which uses a reset button for restart.

**CAUTION**

- Do not bunch the wires of external devices or communication cables together with the main circuit or power lines, or install them close to each other. They should be installed 100 mm (3.94 inch) or more from each other.
Not doing so could result in noise that would cause malfunctions.

4.1 Module Installation

4.1.1 Handling instructions

**CAUTION**

- Use a safety PLC in the environment that meets the general specifications described in this manual. Using this PLC in an environment outside the range of the general specifications could result in electric shock, fire, erroneous operation, and damage to or deterioration of the product.
- While pressing the installation lever located at the bottom of module, insert the module fixing tab into the fixing hole in the base unit until it stops. Then, securely mount the module with the fixing hole as a supporting point. Incorrect loading of the module can cause a failure or drop.
Secure the module to the base unit with screws. Tighten the screw in the specified torque range. If the screws are too loose, it may cause a drop of the screw or module.
Over tightening may cause a drop due to the damage of the screw or module.
- Completely turn off the external supply power used in the system before mounting or removing the module. Not doing so could result in damage to the product.
- Do not directly touch the module's conductive parts or electronic components.
Doing so may cause malfunctions or a failure.

This section gives instructions for handling the CPU, and power supply modules, base unit and so on.

- (1) Do not drop the module case and main module or subject them to strong impact.
- (2) Do not remove modules' printed circuit boards from the enclosure in order to avoid changes in operation.
- (3) Be sure to install a power supply module in the power supply installation slot of QS034B.
- (4) Tighten the module mounting and fixing screws as specified below.

Screw	Tightening Torque Range
Module fixing screw (M3× 12 screw)	0.36 to 0.48 N•m
Power supply module terminal screw (M3.5 screw)	0.66 to 0.89 N•m

4.1.2 Instructions for mounting the base unit

When mounting the PLC to an enclosure or the like, fully consider its operability, maintainability and environmental resistance.

- (1) Mounting dimensions

Mounting dimensions of each base unit are as follows:

- a) Safety main base unit (QS034B)

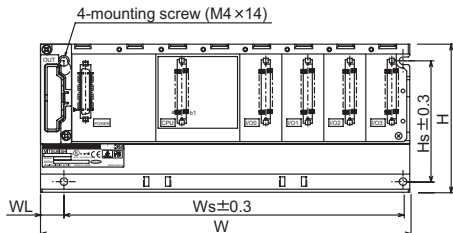

	QS034B
W	245 (9.65)
Ws	224.5 (8.85)
WL	15.5 (0.61)
H	98 (3.86)
Hs	80 (3.15)

Unit: mm (inch)

(2) Unit mounting position

For enhanced ventilation and ease of module replacement, leave the following clearances between the unit top/bottom and structure/parts.

a) Safety main base unit (QS034B)

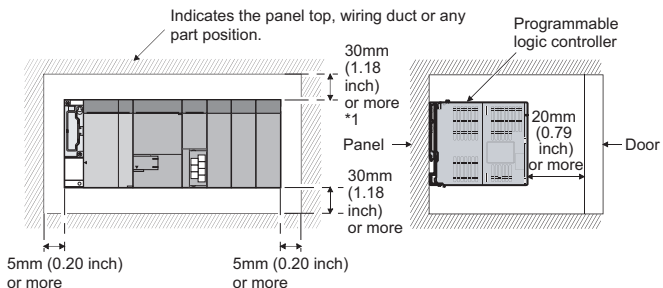

*1: For wiring duct with 50mm (1.97 inch) or less height.
40mm (1.58inch) or more for other cases.

(3) Unit mounting orientation

a) Since the PLC generates heat, it should be mounted on a well ventilated location in the orientation shown below.

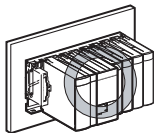

b) Do not mount it in either of the orientations shown below.

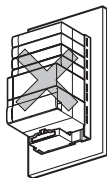

Vertical mounting

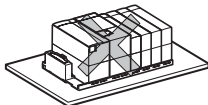
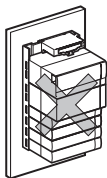

Horizontal installation

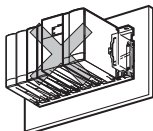

Horizontal mounting

- (4) Mount the base unit on a flat surface. If the mounting surface is not even, this may strain the printed circuit boards and cause malfunctions.
- (5) Avoid mounting base unit in proximity to vibration sources such as large magnetic contractors and no-fuse circuit breakers; mount these on a separate panel or at a distance.
- (6) In order to avoid the effects of radiated noise and heat, provide the clearances indicated below between the PLC and devices that generate noise or heat (contactors and relays).
 - Required clearance in front of PLC: at least 100 mm (3.94 inch) *1
 - Required clearance on the right and left of PLC: at least 50 mm (1.97 inch)

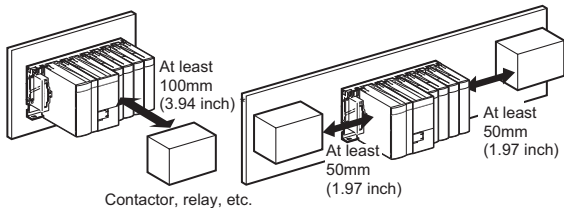

- (7) Install a base unit (by screwing) in the following procedure.
- a) Fit the two base unit top mounting screws into the enclosure.

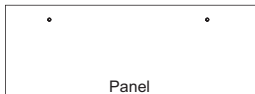

- b) Place the right-hand side notch of the base unit onto the right-hand side screw.

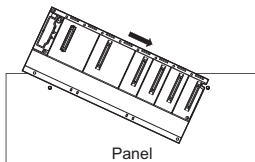

- c) Place the left-hand side pear-shaped hole onto the left-hand side screw.

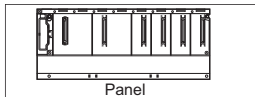

- d) Fit the mounting screws into the holes at the bottom of the base unit, and then retighten the 4 mounting screws.

Note1: Install the base unit to a panel, with no module loaded in the right-end slot.

Remove the base unit after unloading the module from the right-end slot.

- (8) Note the following points when mounting a DIN rail.
Mounting a DIN rail needs special adaptors (optional), which are to be user-prepared.

a) Applicable adapter types

DIN rail adapter	Applicable main base unit
Q6DIN2	QS034B

Included parts

DIN rail mounting adaptors	Quantity of included parts				
	Adaptor (Large)	Adaptor (small)	Mounting screw (M5 × 10)	Squarewasher	Stopper
Q6DIN2	2	3	2	2	2

b) Adaptor installation method

The way to install the adaptors for mounting a DIN rail to the base unit is given below.

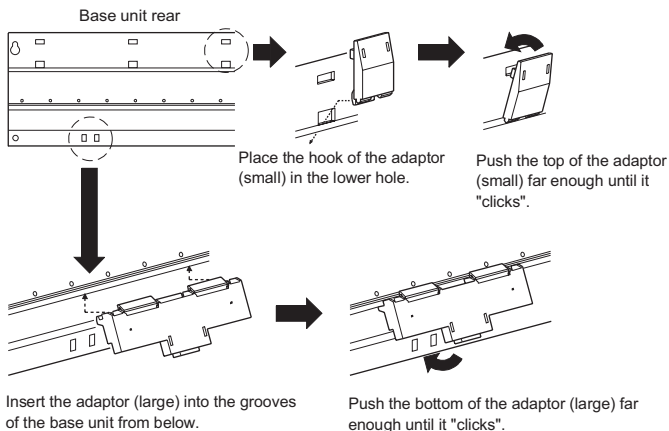

c) Applicable DIN rail types (JIS C 2812)

TH35-7.5Fe
TH35-7.5Al
TH35-15Fe

d) DIN rail mounting screw intervals

When using a TH35-7.5Fe or TH35-7.5Al DIN rail, rail mounting screws (user prepared) should be tightened at intervals of 200 mm (7.88 inch) or less in order to ensure that the rail has sufficient strength.

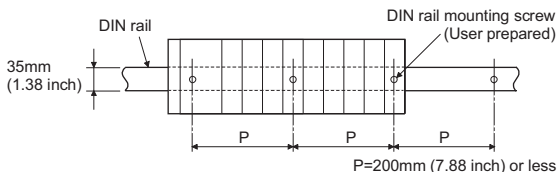

When using the DIN rail in a place of strong vibration and/or shock, tighten the mounting screws at intervals of 200mm (7.88 inch) or less according to the following method.

In Position A (base unit bottom), screw the DIN rail in two places using the mounting screws and square washers included with the adaptors.

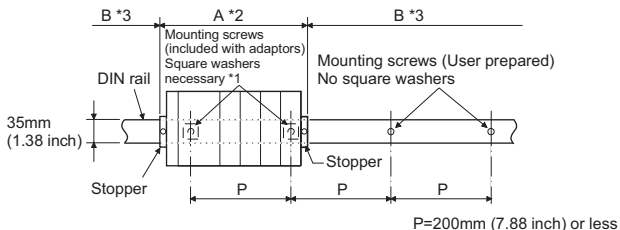

*1:

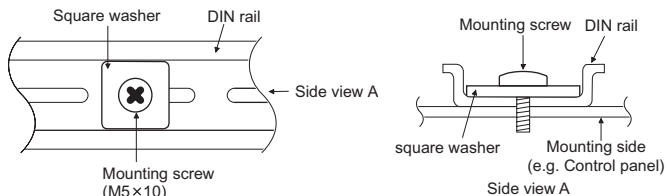

- *2: In Position A (base unit bottom), screw the DIN rail to a control panel using the mounting screws and square washers included with the adaptors.
- *3: In Position B (where the base unit is not installed), supplied mounting screws and square washers are not used. Screw the DIN rail with user-prepared mounting screws.

POINT

- 1) Use only one washer for each mounting screw. Use only the square washers supplied with the adaptors. If two or more washers are used together for one mounting screw, the screw may interfere with the base unit.
- 2) Be sure to align the square washer sides with the DIN rail.

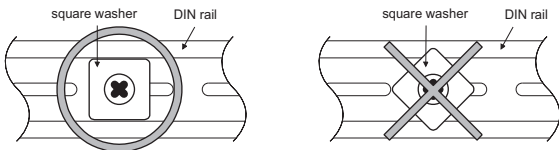

- 3) Use the DIN rail that accepts M5 size screws.

e) Stopper mounting

When using the DIN rail in a place of large vibration and/or shock, fix the base unit using the stoppers supplied with the DIN rail mounting adaptors indicated in a).

1) Loosen the screw at the top of the stopper. (2 stoppers)

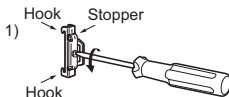

2) Hitch the lower hook of the stopper to the bottom of the DIN rail. Install the stopper with the arrowhead side facing up.

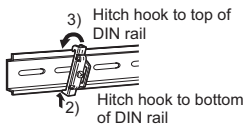

3) Hitch the upper hook of the stopper to the top of the DIN rail.

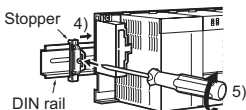

4) Slide the stopper to the end of the base unit so that they are fully in contact.

(Left side)

5) Tighten the screw of the stopper with a screwdriver. (Tightening torque 1.00 to 1.35N·m)

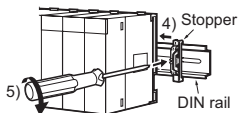

(Right side)

Make sure that the left and right stoppers are fixed securely to the DIN rail.



Complete

POINT

When stoppers are used, install the base unit to a control panel considering stopper dimensions. Refer to Section 4.1.2 (1) for the base unit dimensions (W).

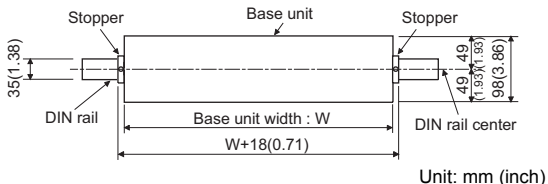

f) Side dimensions when DIN rail is attached

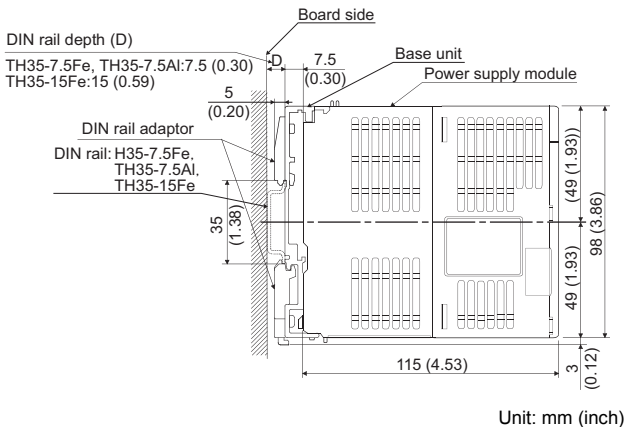

4.1.3 Installation and removal of module

This section explains how to install and remove a power supply, CPU, I/O, intelligent function or another module to and from the base unit.

(1) Mounting of module

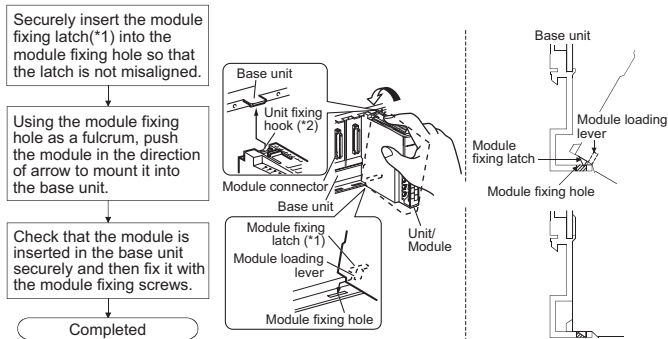

*1: The power supply module and CPU module has two module fixing latches. Insert the two module fixing latches on the right and left into the module fixing holes so that they are not misaligned.

*2: The power supply module and CPU module has two module fixing hooks on its top. Push the center top of the power supply module and CPU module and mount the module so that the two module fixing hooks on the right and left are securely engaged with the base unit hooks.

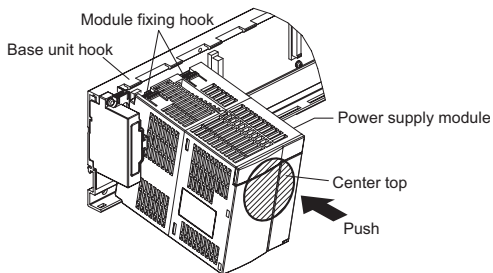

POINT

- 1)When mounting the module, always insert the module fixing latch into the module fixing hole of the base unit.
At that time, securely insert the module fixing latch so that it does not come off from the module fixing hole.
If the module is forcibly mounted without the latch being inserted, the module connector and module will be damaged.
- 2)Do not mount/remove the module onto/from base unit more than 50 times (IEC61131-2-compliant), after the first use of the product.
Failure to do so may cause the module to malfunction due to poor contact of connector.

(2) Removing of module

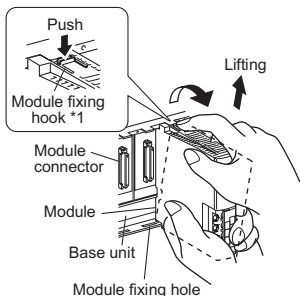
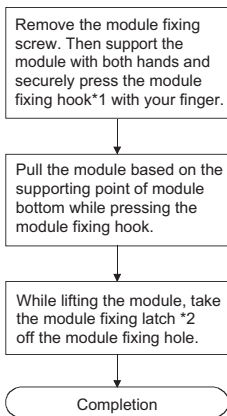

*1: The power supply module and CPU module has two module fixing hooks on its top. Push the two module fixing hooks on the right and left of the module top simultaneously with your fingers until they stop.

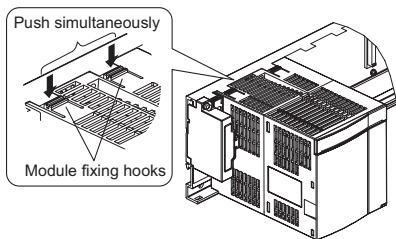

*2: The power supply module and CPU module has two module fixing latches. Remove the two module fixing latches on the right and left of the module bottom from the module fixing holes.

POINT

When removing the module, always remove the module fixing screw first, and then remove the module fixing latch from the module fixing hole. If the module is removed forcibly, it will be damaged.

4.2 Power Supply Wiring

This section provides instructions for wiring the power supply.



DANGER

- Be sure to shut off all phases of the external supply power used by the system before wiring.
Not completely turning off all power could result in electric shock or damage to the product.
- When energizing or operating the module after installation or wiring, be sure to close the attached terminal cover.
Not doing so may result in electric shock.



CAUTION

- Ground the FG and LG terminals correctly.
Not doing so could result in electric shock or malfunctions.
- Use a solderless terminal with insulation sleeve for wiring of a terminal block.
Use up to two solderless terminals for a single terminal.
- Use applicable solderless terminals and tighten them with the specified torque. If any solderless spade terminal is used, it may be disconnected when the terminal screw comes loose, resulting in a failure.
- Wire the module correctly after confirming the rated voltage and terminal layout.
Connecting a power supply of a different rated voltage or incorrect wiring may cause a fire or failure.
- Tighten a terminal block mounting screw, terminal screw, and module mounting screw within the specified torque range. If the terminal block mounting screw or terminal screw is too loose, it may cause a short circuit, fire, or malfunctions. If too tight, it may damage the screw and/or the module, resulting in a drop of the screw or module, a short circuit or malfunctions. If the module mounting screw is too loose, it may cause a drop of the screw or module. Over tightening the screw may cause a drop due to the damage of the screw or module.
- Be sure there are no foreign substances such as sawdust or wiring debris inside the module. Such debris could cause a fire, failure, or malfunctions.



CAUTION

- The module has an ingress prevention label on its top to prevent foreign matter, such as wire offcuts, from entering the module during wiring. Do not peel this label during wiring. Before starting system operation, be sure to peel this label because of heat dissipation.
- Install our PLC in a control panel for use. Wire the main power supply to the power supply module installed in a control panel through a distribution terminal block. Furthermore, the wiring and replacement of a power supply module have to be performed by a maintenance worker who acquainted with shock protection. (For the wiring methods, refer to the QSCPU User's Manual (Hardware Design, Maintenance and Inspection))

- (1) Separate the PLC's power supply line from the lines for I/O devices and power devices as shown below.

When there is much noise, connect an insulation transformer.

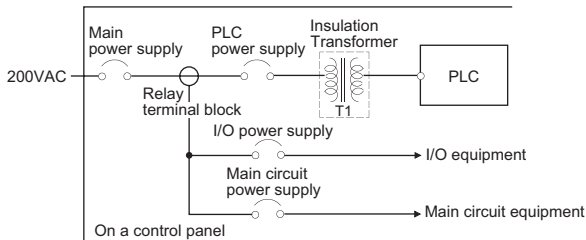

- (2) When wiring the power supply, always connect the appropriate breaker or external fuse that has blown / detection characteristics, in consideration of the rated current and inrush current of the power supply module.
- (3) When using the PLC independently, 10A breaker or the external fuse is recommended in view of wire protection.
- (4) 100VAC and 200VAC wires should be twisted as dense as possible. Connect the modules with the shortest distance. Also, to reduce the voltage drop to the minimum, use the thickest wires possible (maximum 2mm^2).

- (5) Do not bundle the 100VAC and 200VAC wires with, or run them close to, the main circuit (high voltage, large current) and I/O signal lines (including common line). Reserve a distance of at least 100mm (3.94 inch) from adjacent wires.
- (6) As a countermeasure to power surge due to lightning, connect a surge absorber for lightning as shown below.

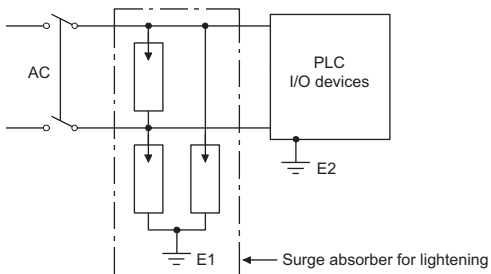

POINT

- 1) Separate the ground of the surge absorber for lightning (E1) from that of the PLC (E2).
- 2) Select a surge absorber for lightning whose power supply voltage does not exceed the maximum allowable circuit voltage even at the time of maximum power supply voltage elevation.

- (7) The following diagram shows the wiring example of power lines, grounding lines, etc. to the unit.

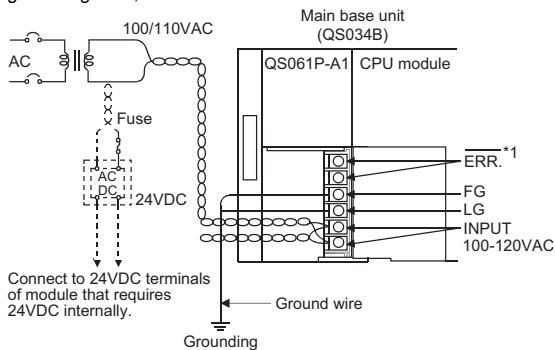

- *1: The ERR. terminal turns ON/OFF as described below.
 The terminal turns OFF (opens) when the AC power is not input, a CPU module stop error (including a reset) occurs, or the fuse of the power supply module is blown.

POINT

- 1) Use the thickest possible (max. 2 mm² (14 AWG)) wires for the 100/200 VAC and 24 VDC power cables. Be sure to twist these wires starting at the connection terminals. For wiring a terminal block, be sure to use a solderless terminal. To prevent short-circuit due to loosening screws, use the solderless terminals with insulation sleeves of 0.8 mm (0.03 inch) or less thick. The number of the solderless terminals to be connected for one terminal block are limited to 2.

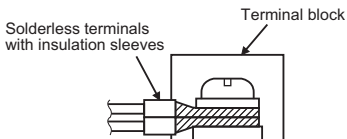

- 2) When the LG terminals and FG terminals are connected, be sure to ground the wires. Do not connect the LG terminals and FG terminals to anything other than ground. If LG terminals and FG terminals are connected without grounding the wires, the PLC may be susceptible to noise. In addition, since the LG terminals have potential, the operator may receive an electric shock when touching metal parts.
- 3) The ERR terminal can not be used as a safety output. In addition, set the cable for ERR contact in the control panel and its length to 30m (98.43 ft.) or less.

4.2.1 Precaution when connecting the uninterruptive power supply

Be sure of the following terms when connecting the QS Series CPU Module system to the uninterruptive power supply (abbreviated as UPS hereafter):

As for UPS, use the online power system or online interactive system with a voltage distortion rate of 5% or less.

For the UPS of the commercial online power system, use Mitsubishi Electric's F Series UPS (serial number P or later) (Ex.: FW-F10-0.3K/0.5K).

Do not use any UPS of the commercial online power system other than the F series mentioned above.

4.3 Part Names and Settings of QS001CPU

4.3.1 Part names and settings

(1) QS001CPU

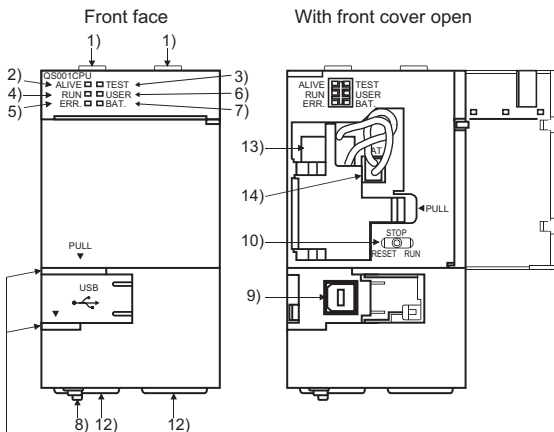

When opening the cover,
put your finger here.

Side face

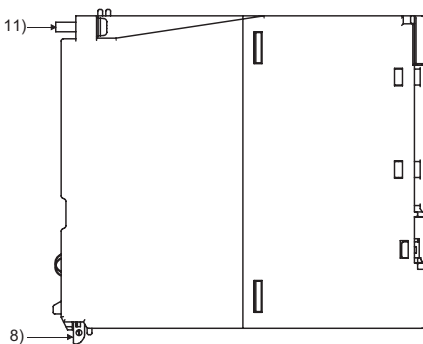

No.	Name	Application
1)	Module fixing hook	Hook used to fix the module to the base unit.
2)	"ALIVE" LED (Green)	ON : Normal ^{*1} OFF : When the hardware watchdog timer error is detected ("ERR." LED is ON.)
3)	"TEST" LED (Yellow)	Indicates the operating mode of the CPU module. ON : TEST MODE ^{*1} Flash : When TEST MODE is switched to SAFETY MODE The "TEST" LED turns off after reset (Flash interval: ON 200ms/OFF 200ms) OFF : SAFETY MODE
4)	"RUN" LED (Green)	Indicates the operating status of the CPU module. ON : During operation in "RUN" ^{*1} OFF : During stop in "STOP" or when the error which stops the operation is detected Flash : When parameters/program is written during STOP and the RUN/STOP/RESET switch is moved from "STOP" to "RUN" (Flash interval: ON 200ms/OFF 200ms)
5)	"ERR." LED (Red)	ON : When the self-diagnostics error that will not stop operation, other than a battery error, is detected ^{*1} OFF : Normal Flash : When the self-diagnostics error that will stop operation is detected (Flash interval: ON 200ms/OFF 200ms) When the reset operation is performed (Flash interval: ON 60ms/OFF 60ms)
6)	"USER" LED (Red)	ON : When the annunciator (F) turns ON ^{*1} OFF : Normal
7)	"BAT." LED (Yellow)	ON : When a battery error has occurred due to the CPU battery voltage drop ^{*1} OFF : Normal
8)	Module loading lever	Used to load the module to the safety base unit.
9)	USB connector ^{*2}	Connector used to connect to the USB compatible peripheral devices. (Connector type B) Can be connected by the USB cable.
10)	RUN/STOP/RESET switch ^{*3}	RUN : Executes sequence program operation. STOP : Stops sequence program operation. RESET : Performs hardware reset and operation initialization when an operation error occurs. (See section 4.3.3)
11)	Module fixing screw	Screw used to fix a module to the base unit. (M3 screw)

No.	Name	Application
12)	Module fixing latch	Latch used to fix a module to the base unit.
13)	Battery	Backup battery for the power failure compensation function of program memory.
14)	Battery connector pin	For connection of the battery lead wires (When shipped from the factory, the lead wires are disconnected from the connector to prevent the battery from discharging.)

- *1: Turns ON during the initial processing (self-diagnostics, etc.) right after the power-on or reset cancel.
- *2: When a cable is to be connected to the USB connector at all times, clamp the cable to prevent a loose connection, shifting, or disconnection by pulling due to carelessness.
- *3: Operate the RUN/STOP/RESET switch with your fingertips. Do not use any tool such as a screwdriver because the switch part might be damaged.

4.3.2 Switch Operation after Writing a Program

Programs can be written to the CPU module in either the STOP or RUN status.

- (1) When writing a program with the CPU module set to "STOP"
 - a) Set the RUN/STOP/RESET switch to STOP.
The "RUN" LED turns OFF, and the module is placed in the STOP status.
Write a program from GX Developer to the CPU module in the STOP status.
 - b) Reset with the RUN/STOP/RESET switch.
The CPU module is reset. (See Section 4.3.3)
 - c) Set the RUN/STOP/RESET switch to RUN.
The "RUN" LED flashes, and the CPU module is placed in the RUN status.
- (2) When writing a program during RUN
When writing a program during RUN, the operation for the RUN/STOP/RESET switch is not required.

POINT

- | |
|--|
| <ol style="list-style-type: none">1)The program modified online during boot operation is written to the program memory.
After making online program change, also write the program to the standard ROM of the boot source memory. If the program is not written in the standard ROM, the old program will be executed at the next boot operation.
(For details of boot operation, refer to QSCPU User's Manual (Function Explanation, Program Fundamentals).)2)To stop the CPU module, the remote operation of GX Developer can also be used.
In this case, the operation for the RUN/STOP/RESET switch is not required.
(For details of remote operation of GX Developer, refer to GX Developer Version 8 Operating Manual.) |
|--|

4.3.3 Reset Operation

For the CPU module, the RUN/STOP/RESET switch of the CPU module is used to switch between the "RUN status" and "STOP status" and to perform "RESET operation".

When using the RUN/STOP/RESET switch to reset the CPU module, moving the RUN/STOP/RESET switch to the reset position will not reset it immediately.

POINT

<p>Hold the RUN/STOP/RESET switch in the RESET position until reset processing is complete (the flickering ERR. LED goes off). If you release your hand from the RUN/STOP/RESET switch during reset processing (during rapid flickering of ERR. LED), the switch will return to the STOP position and reset processing cannot be completed.</p>

Perform reset operation with the RUN/STOP/RESET switch in the following procedure.

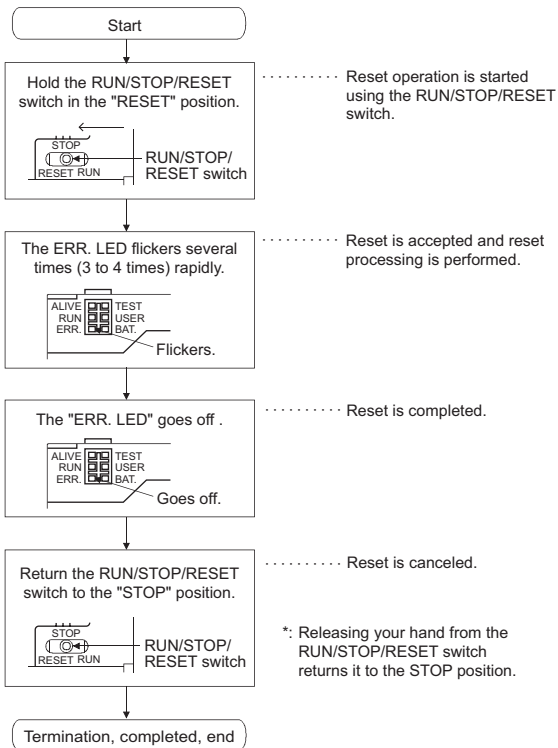

POINT

Operate the RUN/STOP/RESET switch with your fingertips.
Do not use any tool such as a screwdriver because the switch part might be damaged.

4.3.4 Part Names of Power Supply Modules

(1) QS061P-A1, QS061P-A2

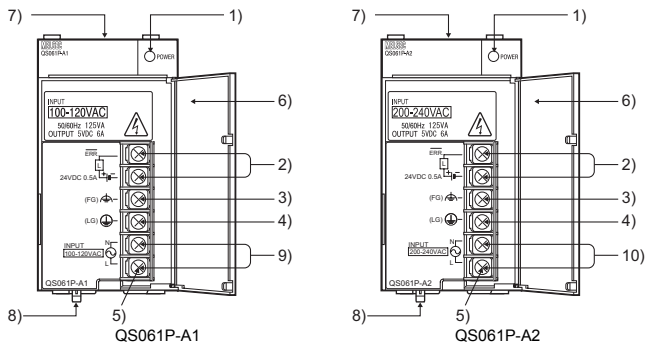

No.	Name	Application
1)	"POWER" LED	<p>ON (green): Normal (5VDC output, instantaneous power failure within 20ms)</p> <p>OFF : • AC power supply is ON, however, the power supply module is out of order. (5VDC error, overload, internal circuit failure, fuse blown)</p> <p>• AC power supply is not ON.</p> <p>• Power failure (including an instantaneous power failure of 20ms or more)</p>
2)	ERR terminal	<ul style="list-style-type: none"> • Turned ON when the whole system operates normally. • Turns OFF (opens) when the AC power is not input, a stop error (including a reset) occurs in the CPU module, or the fuse is blown.
3)	FG terminal	Ground terminal connected to the shielding pattern of the printed circuit board.
4)	LG terminal	Grounding for the power filter. The potential of the QS061P-A1 and QS061P-A2 terminals are one-half of the input voltage.
5)	Terminal screw	M3.5 screw
6)	Terminal cover	Protective cover of the terminal block
7)	Module fixing screw	Used to fix the module to the base unit. M3 screw (Tightening torque : 0.36 to 0.48N•m)
8)	Module loading lever	Used to load the module to the base unit.
9)	Power input terminal	Power input terminal for the QS061P-A1 and connected to a 100VAC power supply.
10)	Power input terminal	Power input terminal for the QS061P-A2 and connected to a 200VAC power supply.

POINT

- 1)The QS061P-A1 is dedicated for inputting a voltage of 100 VAC. Do not input a voltage of 200 VAC into it or trouble may occur on the QS061P-A1

Power module type	Supply power voltage	
	100VAC	200VAC
QS061P-A1	Operates normally.	Power supply module causes trouble.
QS061P-A2	Power supply module does not cause trouble. CPU module cannot be operated.	Operates normally.

- 2)Ensure that the earth terminals LG and FG are grounded.
- 3)ERR. terminal cannot be used as a safety output.
Connect the cable for ERR. contact of 30m or less in length in a control panel.

4.3.5 Part Names of Base unit

(1) QS034B

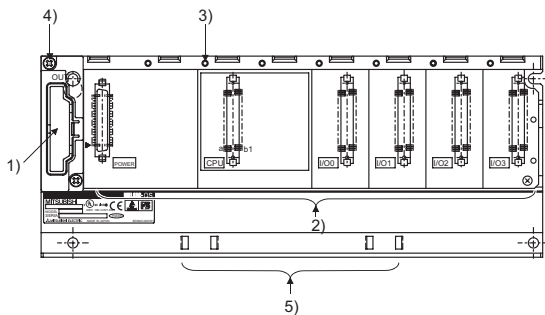

No.	Name	Application
1)	Base cover	Cover for protecting the printed-circuit board of the base unit.
2)	Module connector	Connector for installing the QS series power supply module, CPU module and intelligent function module. To the connectors located in the spare space where these modules are not installed, attach the supplied connector cover or the blank cover module (QG60) to prevent entry of dirt.
3)	Module fixing screw hole	Screw hole for fixing the module to the base unit. Screw size: M3×12
4)	Base mounting hole	Hole for mounting this base unit onto the panel of the control panel. (for M4 screw)
5)	DIN rail adapter mounting hole	Hole for mounting DIN rail adapter.

5. ERROR CODES

The QS series CPU module uses the self diagnostics function to display error information (LED indication) and stores the information into the special relay SM and special register SD, when an error occurs in the following situations:

- When the PLC is powered ON.
- When the CPU module is reset.
- When the CPU module is switched from STOP to RUN.
- While the CPU module is running.

REMARK

For error codes (4000H to 4FFFH) for errors occurred at communication request from GX Developer to the CPU module, refer to QSCPU User's Manual (Hardware Design, Maintenance and Inspection).

5.1 Reading an error code

When error occurs, GX Developer reads the error codes, error messages and others to execute troubleshooting.

The following shows the procedure to read the error code with GX Developer.

- (1) Start GX Developer.
- (2) Connect the CPU module to the personal computer that started GX Developer.
- (3) On GX Developer, choose the [Online]→[Transfer setup] menu and specify the port and the CPU module from which the error code will be read.
- (4) Choose the [Diagnostic]→[PLC diagnostic] menu.
- (5) Click the "Current error" button in the PLC diagnostic dialog box to display the error code and error message.
- (6) Choose the [Help]→[CPU error] menu and check details of the corresponding error code.

For details of how to operate GX Developer, refer to the operating manual of your GX Developer.

6. TRANSPORTATION PRECAUTIONS

When transporting lithium batteries, make sure to treat them based on the transport regulations.

6.1 Controlled Models

The batteries for the MELSEC-QS series CPU module are classified as follows:

Product name	Model	Product supply status	Classification for transportation
Q series battery	Q6BAT	Lithium battery	Non-dangerous goods

6.2 Transport Guidelines

Comply with IATA Dangerous Goods Regulations, IMDG code and the local transport regulations when transporting products after unpacking or repacking, while Mitsubishi ships products with packages to comply with the transport regulations.

Also, contact the transporters.

WARRANTY

Please confirm the following product warranty details before using this product.

1. Limited Warranty and Product Support.

- a. Mitsubishi Electric Company ("MELCO") warrants that for a period of eighteen (18) months after date of delivery from the point of manufacture or one year from date of Customer's purchase, whichever is less, Mitsubishi MELSEC Safety programmable logic controllers (the "Products") will be free from defects in material and workmanship.
- b. At MELCO's option, for those Products MELCO determines are not as warranted, MELCO shall either repair or replace them or issue a credit or return the purchase price paid for them.
- c. For this warranty to apply:
 - (1) Customer shall give MELCO (i) notice of a warranty claim to MELCO and the authorized dealer or distributor from whom the Products were purchased, (ii) the notice shall describe in reasonable details the warranty problem, (iii) the notice shall be provided promptly and in no event later than thirty (30) days after the Customer knows or has reason to believe that Products are not as warranted, and (iv) in any event, the notice must be given within the warranty period;
 - (2) Customer shall cooperate with MELCO and MELCO's representatives in MELCO's investigation of the warranty claim, including preserving evidence of the claim and its causes, meaningfully responding to MELCO's questions and investigation of the problem, grant MELCO access to witnesses, personnel, documents, physical evidence and records concerning the warranty problem, and allow MELCO to examine and test the Products in question onsite or at the premises where they are installed or used; and
 - (3) If MELCO requests, Customer shall remove Products it claims are defective and ship them to MELCO or MELCO's authorized representative for examination and, if found defective, for repair or replacement. The costs of removal, shipment to and from MELCO's designated examination point, and reinstallation of repaired or replaced Products shall be at Customer's expense.
 - (4) If Customer requests and MELCO agrees to effect repairs onsite at any domestic or overseas location, the Customer will pay for the costs of sending repair personnel and shipping parts. MELCO is not responsible for any re-commissioning, maintenance, or testing on-site that involves repairs or replacing of the Products.
- d. Repairs of Products located outside of Japan are accepted by MELCO's local authorized service facility centers ("FA Centers"). Terms and conditions on which each FA Center offers repair services for Products that are out of warranty or not covered by MELCO's limited warranty may vary.
- e. Subject to availability of spare parts, MELCO will offer Product repair services for (7) years after each Product model or line is discontinued, at MELCO's or its FA Centers' rates and charges and standard terms in effect at the time of repair. MELCO usually produces and retains sufficient spare parts for repairs of its Products for a period of seven (7) years after production is discontinued.
- f. MELCO generally announces discontinuation of Products through MELCO's Technical Bulletins. Products discontinued and repair parts for them may not be available after their production is discontinued.

2. Limits of Warranties.

- a. MELCO does not warrant or guarantee the design, specify, manufacture, construction or installation of the materials, construction criteria, functionality, use, properties or other characteristics of the equipment, systems, or production lines into which the Products may be incorporated, including any safety, fail-safe and shut down systems using the Products.
- b. MELCO is not responsible for determining the suitability of the Products for their intended purpose and use, including determining if the Products provide appropriate safety margins and redundancies for the applications, equipment or systems into which they are incorporated.
- c. Customer acknowledges that qualified and experienced personnel are required to determine the suitability, application, design, construction and proper installation and integration of the Products. MELCO does not supply such personnel.
- d. MELCO is not responsible for designing and conducting tests to determine that the Product functions appropriately and meets application standards and requirements as installed or incorporated into the end-user's equipment, production lines or systems.
- e. MELCO does not warrant any Product:
 - (1) repaired or altered by persons other than MELCO or its authorized engineers or FA Centers;
 - (2) subjected to negligence, carelessness, accident, misuse, or damage;
 - (3) improperly stored, handled, installed or maintained;
 - (4) integrated or used in connection with improperly designed, incompatible or defective hardware or software;
 - (5) that fails because consumable parts such as batteries, backlights, or fuses were not tested, serviced or replaced;
 - (6) operated or used with equipment, production lines or systems that do not meet applicable and commensurate legal, safety and industry-accepted standards;
 - (7) operated or used in abnormal applications;
 - (8) installed, operated or used in contravention of instructions, precautions or warnings contained in MELCO's user, instruction and/or safety manuals, technical bulletins and guidelines for the Products;
 - (9) used with obsolete technologies or technologies not fully tested and widely accepted and in use at the time of the Product's manufacture;
 - (10) subjected to excessive heat or moisture, abnormal voltages, shock, excessive vibration, physical damage or other improper environment; or
 - (11) damaged or malfunctioning due to Acts of God, fires, acts of vandals, criminals or terrorists, communication or power failures, or any other cause or failure that results from circumstances beyond MELCO's control.
- f. All Product information and specifications contained on MELCO's website and in catalogs, manuals, or technical information materials provided by MELCO are subject to change without prior notice.
- g. The Product information and statements contained on MELCO's website and in catalogs, manuals, technical bulletins or other materials provided by MELCO are provided as a guide for Customer's use. They do not constitute warranties and are not incorporated in the contract of sale for the Products.
- h. These terms and conditions constitute the entire agreement between Customer and MELCO with respect to warranties, remedies and damages and supersede any other understandings, whether written or oral, between the parties. Customer expressly acknowledges that any representations or statements made by MELCO or others concerning the Products outside these terms are not part of the basis of the bargain between the parties and are not factored into the pricing of the Products.
- i. THE WARRANTIES AND REMEDIES SET FORTH IN THESE TERMS ARE THE EXCLUSIVE AND ONLY WARRANTIES AND REMEDIES THAT APPLY TO THE PRODUCTS.
- j. MELCO DISCLAIMS THE IMPLIED WARRANTIES OF MERCHANTABILITY AND FITNESS FOR A PARTICULAR PURPOSE.

3. Limits on Damages.

- a. MELCO'S MAXIMUM CUMULATIVE LIABILITY BASED ON ANY CLAIMS FOR BREACH OF WARRANTY OR CONTRACT, NEGLIGENCE, STRICT TORT LIABILITY OR OTHER THEORIES OF RECOVERY REGARDING THE SALE, REPAIR, REPLACEMENT, DELIVERY, PERFORMANCE, CONDITION, SUITABILITY, COMPLIANCE, OR OTHER ASPECTS OF THE PRODUCTS OR THEIR SALE, INSTALLATION OR USE SHALL BE LIMITED TO THE PRICE PAID FOR PRODUCTS NOT AS WARRANTED.
- b. Although MELCO has obtained the certification for Product's compliance to the international safety standards IEC61508 and EN954-1/ISO13849-1 from TUV Rheinland, this fact does not guarantee that Product will be free from any malfunction or failure. The user of this Product shall comply with any and all applicable safety standard, regulation or law and take appropriate safety measures for the system in which the Product is installed or used and shall take the second or third safety measures other than the Product. MELCO is not liable for damages that could have been prevented by compliance with any applicable safety standard, regulation or law.
- c. MELCO prohibits the use of Products with or in any application involving power plants, trains, railway systems, airplanes, airline operations, other transportation systems, amusement equipments, hospitals, medical care, dialysis and life support facilities or equipment, incineration and fuel devices, handling of nuclear or hazardous materials or chemicals, mining and drilling, and other applications where the level of risk to human life, health or property are elevated.
- d. MELCO SHALL NOT BE LIABLE FOR SPECIAL, INCIDENTAL, CONSEQUENTIAL, INDIRECT OR PUNITIVE DAMAGES, FOR LOSS OF PROFITS, SALES, OR REVENUE, FOR INCREASED LABOR OR OVERHEAD COSTS, FOR DOWNTIME OR LOSS OF PRODUCTION, FOR COST OVERRUNS, OR FOR ENVIRONMENTAL OR POLLUTION DAMAGES OR CLEAN-UP COSTS, WHETHER THE LOSS IS BASED ON CLAIMS FOR BREACH OF CONTRACT OR WARRANTY, VIOLATION OF STATUTE, NEGLIGENCE OR OTHER TORT, STRICT LIABILITY OR OTHERWISE.
- e. In the event that any damages which are asserted against MELCO arising out of or relating to the Products or defects in them, consist of personal injury, wrongful death and/or physical property damages as well as damages of a pecuniary nature, the disclaimers and limitations contained in these terms shall apply to all three types of damages to the fullest extent permitted by law. If, however, the personal injury, wrongful death and/or physical property damages cannot be disclaimed or limited by law or public policy to the extent provided by these terms, then in any such event the disclaimer of and limitations on pecuniary or economic consequential and incidental damages shall nevertheless be enforceable to the fullest extent allowed by law.
- f. In no event shall any cause of action arising out of breach of warranty or otherwise concerning the Products be brought by Customer more than one year after the cause of action accrues.
- g. Each of the limitations on remedies and damages set forth in these terms is separate and independently enforceable, notwithstanding the unenforceability or failure of essential purpose of any warranty, undertaking, damage limitation, other provision of these terms or other terms comprising the contract of sale between Customer and MELCO.

4. Delivery/Force Majeure.

- a. Any delivery date for the Products acknowledged by MELCO is an estimated and not a promised date. MELCO will make all reasonable efforts to meet the delivery schedule set forth in Customer's order or the purchase contract but shall not be liable for failure to do so.
- b. Products stored at the request of Customer or because Customer refuses or delays shipment shall be at the risk and expense of Customer.
- c. MELCO shall not be liable for any damage to or loss of the Products or any delay in or failure to deliver, service, repair or replace the Products arising from shortage of raw materials, failure of suppliers to make timely delivery, labor difficulties of any kind, earthquake, fire, windstorm, flood, theft, criminal or terrorist acts, war, embargoes, governmental acts or rulings, loss or damage or delays in carriage, acts of God, vandals or any other circumstances reasonably beyond MELCO's control.

5. Choice of Law/Jurisdiction.

These terms and any agreement or contract between Customer and MELCO shall be governed by the laws of the State of New York without regard to conflicts of laws. To the extent any action or dispute is not arbitrated, the parties consent to the exclusive jurisdiction and venue of the federal and state courts located in the Southern District of the State of New York. Any judgment there obtained may be enforced in any court of competent jurisdiction.

6. Arbitration.

Any controversy or claim arising out of, or relating to or in connection with the Products, their sale or use or these terms, shall be settled by arbitration conducted in accordance with the Center for Public Resources (CPR) Rules for Non-Administered Arbitration of International Disputes, by a sole arbitrator chosen from the CPR's panels of distinguished neutrals. Judgment upon the award rendered by the Arbitrator shall be final and binding and may be entered by any court having jurisdiction thereof. The place of the arbitration shall be New York City, New York. The language of the arbitration shall be English. The neutral organization designated to perform the functions specified in Rule 6 and Rules 7.7(b), 7.8 and 7.9 shall be the CPR.

Country/Region Sales office/Tel	Country/Region Sales office/Tel
U.S.A Mitsubishi Electric Automation Inc. 500 Corporate Woods Parkway Vernon Hills, IL 60061, U.S.A. Tel : +1-847-478-2100	Hong Kong Mitsubishi Electric Automation (Hong Kong) Ltd. 10th Floor, Manulife Tower, 169 Electric Road, North Point, Hong Kong Tel : +852-2887-8870
Brazil MELCO-TEC Rep. Com.e Assessoria Tecnica Ltda. Rua Correia Dias, 184, Edificio Paraiso Trade Center-8 andar Paraiso, Sao Paulo, SP Brazil Tel : +55-11-5908-8331	China Mitsubishi Electric Automation (Shanghai) Ltd. 4/F Zhi Fu Plaza, No.80 Xin Chang Road, Shanghai 200003, China Tel : +86-21-6120-0808
Germany Mitsubishi Electric Europe B.V. German Branch Gothaer Strasse 8 D-40880 Ratingen, GERMANY Tel : +49-2102-486-0	Taiwan Setsuyo Enterprise Co., Ltd. 6F No.105 Wu-Kung 3rd.Rd, Wu-Ku Hsiang, Taipei Hsine, Taiwan Tel : +886-2-2299-2499
U.K Mitsubishi Electric Europe B.V. UK Branch Travellers Lane, Hatfield, Hertfordshire., AL10 8XB, U.K. Tel : +44-1707-276100	Korea Mitsubishi Electric Automation Korea Co., Ltd. 1480-6, Gayang-dong, Gangseo-ku Seoul 157-200, Korea Tel : +82-2-3660-9552
Italy Mitsubishi Electric Europe B.V. Italian Branch Centro Dir. Colleoni, Pal. Perseo-Ingr.2 Via Paracelso 12, I-20041 Agrate Brianza., Milano, Italy Tel : +39-039-60531	Singapore Mitsubishi Electric Asia Pte. Ltd. 307 Alexandra Road #05-01/02, Mitsubishi Electric Building, Singapore 159943 Tel : +65-6470-2460
Spain Mitsubishi Electric Europe B.V. Spanish Branch Carretera de Rubi 76-80, E-08190 Sant Cugat del Valles, Barcelona, Spain Tel : +34-93-565-3131	Thailand Mitsubishi Electric Automation (Thailand) Co., Ltd. Bang-Chan Industrial Estate No.111 Moo 4, Serithai Rd, T.Kannayao, A.Kannayao, Bangkok 10230 Thailand Tel : +66-2-517-1326
France Mitsubishi Electric Europe B.V. French Branch 25, Boulevard des Bouvets, F-92741 Nanterre Cedex, France TEL: +33-1-5568-5568	Indonesia P.T. Autoteknindo Sumber Makmur Muara Karang Selatan, Block A/Utara No.1 Kav. No.11 Kawasan Industri Pergudangan Jakarta - Utara 14440, P.O.Box 5045 Jakarta, 11050 Indonesia Tel : +62-21-6630833
South Africa Circuit Breaker Industries Ltd. Private Bag 2016, ZA-1600 Isando, South Africa Tel : +27-11-928-2000	India Messung Systems Pvt. Ltd. Electronic Sadan NO:III Unit No15, M.I.D.C Bhosari, Pune-411026, India Tel : +91-20-2712-3130
	Australia Mitsubishi Electric Australia Pty. Ltd. 348 Victoria Road, Rydalmere, N.S.W 2116, Australia Tel : +61-2-9684-7777

MITSUBISHI ELECTRIC CORPORATION

HEAD OFFICE : TOKYO BUILDING, 2-7-3 MARUNOUCHI, CHYODA-KU, TOKYO 100-8310, JAPAN
NAGOYA WORKS : 1-14, YADA-MINAMI 5-CHOME, HIGASHI-KU, NAGOYA, JAPAN

When exported from Japan, this manual does not require application to the Ministry of Economy, Trade and Industry for service transaction permission.

Specifications subject to change without notice.
Printed in Japan on recycled paper.