



FX3U-4DA

INSTALLATION MANUAL



Manual Number	JY997D20801
Revision	C
Date	May 2010

This manual describes the part names, dimensions, mounting, and specifications of the product. Before use, read this manual and the manuals of all relevant products fully to acquire proficiency in handling and operating the product. Make sure to learn all the product information, safety information, and precautions. Store this manual in a safe place so that it can be taken out and read whenever necessary. Always forward it to the end user. Registration: The company and product names described in this manual are registered trademarks or the trademarks of their respective companies. Effective May 2010. Specifications are subject to change without notice. © 2006 Mitsubishi Electric Corporation

Safety Precaution (Read these precautions before use.)

This manual classifies the safety precautions into two categories:

⚠DANGER and ⚠CAUTION.

⚠DANGER	Indicates that incorrect handling may cause hazardous conditions, resulting in death or severe injury.
⚠CAUTION	Indicates that incorrect handling may cause hazardous conditions, resulting in medium or slight personal injury or physical damage.

Depending on the circumstances, procedures indicated by ⚠CAUTION may also cause severe injury. It is important to follow all precautions for personal safety.

Associated Manuals

Manual name	Manual No.	Description
FX3U / FX3UC Series User's Manual - Analog Control Edition	JY997D16701 MODEL CODE: 09R619	Describes specifications for analog control and programming method for FX3U / FX3UC Series PLC.
FX3U/FX3UC Series Programming Manual - Basic & Applied Instruction Edition	JY997D16601 MODEL CODE: 09R517	Describes PLC programming for basic/applied instructions and devices.
FX3U Series User's Manual - Hardware Edition	JY997D16501 MODEL CODE: 09R516	Explains the FX3U Series PLC specifications for I/O, wiring, installation, and maintenance.
FX3UC Series User's Manual - Hardware Edition	JY997D28701 MODEL CODE: 09R519	Explains the FX3UC Series PLC specifications for I/O, wiring, installation, and maintenance.

How to obtain manuals

For product manuals or documents, consult with the Mitsubishi Electric dealer from who you purchased your product.

Certification of UL, cUL standards

The following product has UL and cUL certification.

UL, cUL File Number: E95239

Models: MELSEC FX3U series manufactured FX3U-4DA

Compliance with EC directive (CE Marking)

This note does not guarantee that an entire mechanical module produced in accordance with the contents of this note will comply with the following standards. Compliance to EMC directive and LVD directive for the entire mechanical module should be checked by the user / manufacturer. For more details please contact the local Mitsubishi Electric sales site.

Requirement for Compliance with EMC directive

The following products have shown compliance through direct testing (of the identified standards below) and design analysis (through the creation of a technical construction file) to the European Directive for Electromagnetic Compatibility (2004/108/EC) when used as directed by the appropriate documentation.

Attention

- This product is designed for use in industrial applications.

Note

- Manufactured by: Mitsubishi Electric Corporation 2-7-3 Marunouchi, Chiyoda-ku, Tokyo, 100-8310 Japan
- Manufactured at: Mitsubishi Electric Corporation Himeji Works 840 Chiyoda-machi, Himeji, Hyogo, 670-8677 Japan
- Authorized Representative in the European Community: Mitsubishi Electric Europe B.V. Gothaer Str. 8, 40880 Ratingen, Germany

Type: Programmable Controller (Open Type Equipment)

Models: MELSEC FX3U series manufactured from February 1st, 2006 FX3U-4DA

Standard	Remark
EN61131-2:2007 Programmable controllers - Equipment requirements and tests	Compliance with all relevant aspects of the standard.
EMI	<ul style="list-style-type: none"> Radiated Emissions Mains Terminal Voltage Emissions
EMS	<ul style="list-style-type: none"> RF immunity Fast Transients ESD Surge Conducted Power magnetic fields

Caution for EC Directive

The FX3U-4DA have been found to be compliant to the European standards in the aforesaid manual and directive. However, for the very best performance from what are in fact delicate measuring and controlled output device Mitsubishi Electric would like to make the following points: As analog devices are sensitive by nature, their use should be considered carefully. For users of proprietary cables (integral with sensors or actuators), these users should follow those manufacturers installation requirements. Mitsubishi Electric recommend that shielded cables should be used. If NO other EMC protection is provided, then users may experience temporary loss or accuracy between ±10% in very heavy industrial areas. However, Mitsubishi Electric suggest that if adequate EMC precautions are followed for the users complete control system, users should expect accuracy as specified in this manual.

- Sensitive analog cable should not be laid in the same trunking or cable conduit as high voltage cabling. Where possible users should run analog cables separately.
- Good cable shielding should be used. Ground the shield of the twisted shielded cable at one point on the signal receiving side.
- Please use FX3U-4DA while installed in a shielded enclosure. For the details, refer to the following manual.

→ Refer to the FX3U Series User's Manual - Hardware Edition
→ Refer to the FX3UC Series User's Manual - Hardware Edition

Note for compliance with EN61131-2:2007

General note on the use of the power supply cable. The FX3U-4DA unit requires that the cable used for power supply is 30m or less.

1. Outline

The FX3U-4DA special function block for analog output converts digital values supplied from PLC into analog values (voltage, current) and outputs those analog values from its four output points.

1.1 Incorporated Items

Check if the following product and items are included in the package:

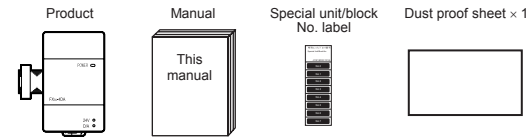

1.2 External Dimensions, Part Names, and Terminal Layout

1.2.1 External Dimensions and Part Names

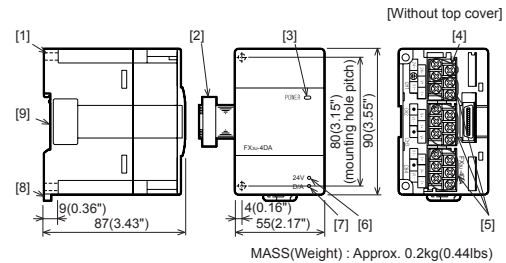

- Direct mounting hole: 2 holes of $\phi 4.5$ (0.18") (mounting screw: M4 screw)
- Extension cable
- POWER LED (green): Lit while 5V DC power is supplied from PLC.
- Terminal block for power supply (24V DC) (M3 terminal screw)
- Terminal block for analog output
- 24V LED (red): Lit while 24V DC power is supplied properly to terminals [24+] and [24-].
- D/A LED (red): Flashes (at high speed) during D/A conversion.
- DIN rail mounting hook
- DIN rail mounting groove (35 mm (1.38") wide)

1.2.2 Terminal Layout

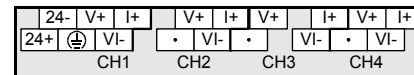

↓ Left side of the product (Extension cable side)

2.1 Arrangements

The product connects on the right side of an PLC main unit or extension units/blocks (including special function units/blocks). For connection to FX3UC Series PLC or FX2NC Series PLC extension block, FX2NC-CNV-IF or FX3UC-1PS-5V is required.

For further information of installation arrangements, refer to the following manual.
→ Refer to the FX3U Series User's Manual - Hardware Edition
→ Refer to the FX3UC Series User's Manual - Hardware Edition

The product is mounted by the following method.

- Direct mounting
- DIN rail mounting

2.1.1 Direct Mounting

The product can be mounted with M4 screws by using the direct mounting holes. Refer to the External Dimensions (section 1.2) for the product's mounting hole pitch information.

An interval space between each unit of 1 to 2 mm (0.04" to 0.08") is necessary. For further information of direct installation, also refer to the following manual.
→ Refer to the FX3U Series User's Manual - Hardware Edition
→ Refer to the FX3UC Series User's Manual - Hardware Edition

2.1.2 DIN Rail Mounting

The product can be mounted on a DIN rail (DIN46227, 35mm width).

- Fit the upper edge of the DIN rail mounting groove (fig. A) onto the DIN rail.
- Press the product against the DIN rail.

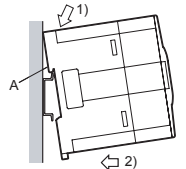

- Connect the extension cable (fig. B) to the main unit, input/output extension unit/block, and special function unit/block on the left. For the details of the extension cable connection, refer to the following manual.

→ Refer to the FX3U Series User's Manual - Hardware Edition
→ Refer to the FX3UC Series User's Manual - Hardware Edition

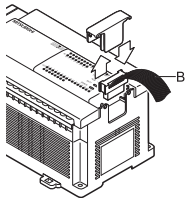

2. Installation

INSTALLATION PRECAUTIONS		⚠CAUTION	
<ul style="list-style-type: none"> Use the product within the generic environment specifications described in PLC main unit manual (Hardware Edition). Never use the product in areas with excessive dust, oily smoke, conductive dusts, corrosive gas (salt air, Cl₂, H₂S, SO₂, or NO₂), flammable gas, vibration or impacts, or exposed to high temperature, condensation, or rain and wind. If the product is used in such conditions, electric shock, fire, malfunctions, deterioration or damage may occur. Do not touch the conductive parts of the product directly. Doing so may cause device failures or malfunctions. Install the product securely using a DIN rail or mounting screws. Install the product on a flat surface. If the mounting surface is rough, undue force will be applied to the PC board, thereby causing nonconformities. When drilling screw holes or wiring, make sure cutting or wire debris does not enter the ventilation slits. Failure to do so may cause fire, equipment failures or malfunctions. Be sure to remove the dust proof sheet from the PLC's ventilation port when installation work is completed. Failure to do so may cause fire, equipment failures or malfunctions. Connect extension cables securely to their designated connectors. Loose connections may cause malfunctions. 			

3. Wiring

WIRING PRECAUTIONS **DANGER**

- Make sure to cut off all phases of the power supply externally before attempting installation or wiring work. Failure to do so may cause electric shock or damage to the product.

WIRING PRECAUTIONS **CAUTION**

- Make sure to observe the following precautions in order to prevent any damage to the machinery or accidents due to abnormal data written to the PLC under the influence of noise:
 - Do not bundle the main circuit line together with or lay it close to the main circuit, high-voltage line or load line. Otherwise, noise disturbance and/or surge induction are likely to take place. As a guideline, lay the control line at least 100mm (3.94") or more away from the main circuit or high-voltage lines.
 - Ground the shield wire or shield of the shielded cable at one point on the PLC. However, do not use common grounding with heavy electrical systems.
- Make sure to properly wire to the terminal blocks in accordance with the following precautions. Failure to do so may cause electric shock, a short-circuit, wire breakage, or damage to the product.
 - The disposal size of the cable end should follow the dimensions described in this manual.
 - Tightening torque should be between 0.5 and 0.8 N·m.

3.1 Applicable Cable and Terminal Tightening Torque

The size of the terminal screws is M3. The end disposal of the cable shows below. Tighten the terminal to a torque of 0.5N·m to 0.8N·m.

- When one wire is connected to one terminal

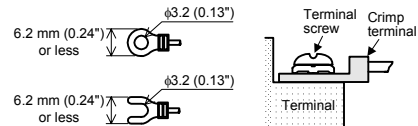

- When two wires are connected to one terminal

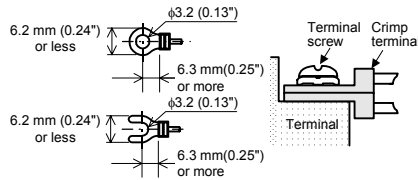

3.2 Power Supply Wiring

For the power supply wiring, refer to the following manual.

→ Refer to the **FX3U / FX3UC Series User's Manual - Analog Control Edition**

3.3 Wiring of Analog Output

→ For the terminal layout, refer to Subsection 1.2.2

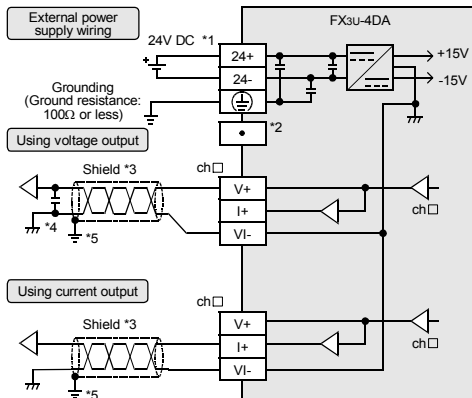

ch □ : □ represents the channel number.

*1 For FX3U Series PLC (AC power type), the 24V DC service power supply is also available.

2 Leave the [] terminal unconnected.

*3 Use a 2-core twisted shield wire for analog output line, and separate it from other power lines or inductive lines.

*4 If there is ripple or noise in the output voltage, connect a capacitor of approximately 0.1 to 0.47 μF 25 V in the vicinity of the signal receiving side.

*5 Ground the shielded wire at one point on the signal receiving side.

3.4 Grounding

Grounding should be performed as stated below.

- The grounding resistance should be 100Ω or less.
- Independent grounding should be performed for best results. When independent grounding is not performed, perform "shared grounding" of the following figure.

→ For details, refer to the **FX3U Series User's Manual - Hardware Edition**.
→ For details, refer to the **FX3UC Series User's Manual - Hardware Edition**.

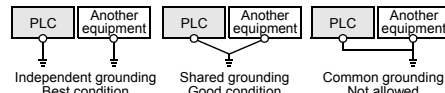

- The grounding wire size should be AWG 14 (2 mm²).
- The grounding point should be close to the PLC, and all grounding wire should be as short as possible.

4. Specifications

STARTUP AND MAINTENANCE PRECAUTIONS **CAUTION**

- Do not disassemble or modify the PLC. Doing so may cause fire, equipment failures, or malfunctions. * For repair, contact your local Mitsubishi Electric distributor.
- Do not drop the product or exert strong impact to it. Doing so may cause damage.

DISPOSAL PRECAUTIONS **CAUTION**

- Please contact a certified electronic waste disposal company for the environmentally safe recycling and disposal of your device.

TRANSPORT AND STORAGE PRECAUTIONS **CAUTION**

- The product is a precision instrument. During transportation, avoid any impacts. Failure to do so may cause failures in the product. After transportation, verify the operations of the product.

4.1 Applicable PLC

Model name	Applicability
FX3U Series PLC	Ver. 2.20 or later (from first production) Up to 8 blocks can be extended
FX3UC Series PLC*1	Ver. 1.30 or later (from the production manufactured in August, 2004 with SER No. 48□□□□) Up to 8 blocks can be extended*2

The version number can be checked by monitoring D8001 as the last three digits indicate it.

*1 An FX2NC-CNV-IF or FX3UC-1PS-5V is necessary to connect the 20SSC-H with the FX3UC PLC.

*2 Up to 7 units can be connected to the FX3UC-32MT-LT PLC.

4.2 General Specifications

For the general specifications other than the following, refer to the manual of the PLC main unit.

The items other than the following are equivalent to those of the PLC main unit.
→ Refer to the **FX3U Series User's Manual - Hardware Edition**.
→ Refer to the **FX3UC Series User's Manual - Hardware Edition**.

Item	Specification
Dielectric withstand voltage	500V AC for one minute Conforming to JEM-1021 Between all terminals and ground terminal of PLC main unit
Insulation resistance	5MΩ or more by 500V DC megger

4.3 Power Supply Specifications

Item	Specification
D/A conversion circuit driving power	24V DC ±10%, 160mA (24V DC power is supplied from the power connector.)
CPU driving power	5V DC, 120mA (5V DC power is supplied from the internal power supply of main unit.)

4.4 Performance Specifications

Item	Description	
	Voltage output	Current output
Analog output range	-10 to +10V DC (External load: 1kΩ to 1MΩ)	0 to 20mA DC (External load: 500 Ω or less)
Offset*1	-10 to +9V ²	0 to 17mA ³
Gain*1	-9 to +10V ²	3 to 30mA ³
Digital input	With sign, 16bits, binary	15bits, binary
Resolution	0.32mV (20V/64000)	0.63μA (20mA/32000)
Total accuracy	<ul style="list-style-type: none"> ±0.3% (±60mV) for full scale of 20V (when ambient temperature is 25°C±5°C) ±0.5% (±100mV) for full scale of 20V (when ambient temperature is 0°C to 55°C) 	<ul style="list-style-type: none"> ±0.3% (±60μA) for full scale of 20mA (when ambient temperature is 25°C±5°C) ±0.5% (±100μA) for full scale of 20mA (when ambient temperature is 0°C to 55°C)
A/D conversion time	1ms (The number of selected channels will not affect this value.)	

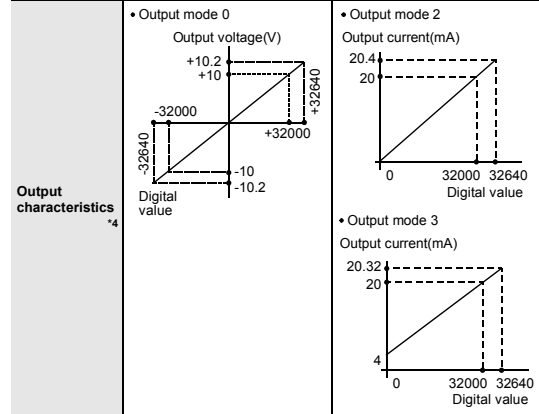

Insulation method

- The photo-coupler insulates the analog output area from the PLC.
- The DC-DC converter insulates the analog output area from the power supply unit.
- Channels are not insulated from each other.

Occupied points

8 point (Count either the input or output points of the PLC.)

*1 Change the offset and gain values to change the output characteristics. However, the resolution doesn't change even when the offset and gain values change.

When analog value (mV, μA) specification is enabled in the output mode 1 or 4, the offset value and the gain value don't change.

*2 The offset and the gain should satisfy the following condition:
1 V ≤ (Gain - Offset) ≤ 10 V

*3 The offset and the gain should satisfy the following condition:
3 mA ≤ (Gain - Offset) ≤ 30 mA

*4 The output characteristics vary depending on the output mode to be used. For the details of the output characteristics, refer to the following manual.

→ Refer to the **FX3U / FX3UC Series User's Manual - Analog Control Edition**

4.5 Output characteristics

The output characteristics in each output mode are as follows.

Output mode	Output mode	Analog output range	Digital input range
0	Voltage output mode	-10 to +10V	-32000 to +32000
1	Voltage output analog value mV specification mode	-10 to +10V	-10000 to +10000
2	Current output mode	0 to 20mA	0 to 32000
3	Current output mode	4 to 20mA	0 to 32000
4	Current output analog value μA specification mode	0 to 20mA	0 to 20000

This manual confers no industrial property rights or any rights of any other kind, nor does it confer any patent licenses. Mitsubishi Electric Corporation cannot be held responsible for any problems involving industrial property rights which may occur as a result of using the contents noted in this manual.

Warranty

Mitsubishi will not be held liable for damage caused by factors found not to be the cause of Mitsubishi; opportunity loss or lost profits caused by faults in the Mitsubishi products; damage, secondary damage, accident compensation caused by special factors unpredictable by Mitsubishi; damages to products other than Mitsubishi products; and to other duties.

For safe use

- This product has been manufactured as a general-purpose part for general industries, and has not been designed or manufactured to be incorporated in a device or system used in purposes related to human life.
- Before using the product for special purposes such as nuclear power, electric power, aerospace, medicine or passenger movement vehicles, consult with Mitsubishi Electric.
- This product has been manufactured under strict quality control. However when installing the product where major accidents or losses could occur if the product fails, install appropriate backup or failsafe functions in the system.

MITSUBISHI *Changes for the Better*
 PROGRAMMABLE CONTROLLERS
FX3U-4DA
INSTALLATION MANUAL

Manual Number	JY997D20801
Revision	C
Date	May 2010

This manual describes the part names, dimensions, mounting, and specifications of the product. Before use, read this manual and the manuals of all relevant products fully to acquire proficiency in handling and operating the product. Make sure to learn all the product information, safety information, and precautions.

Store this manual in a safe place so that it can be taken out and read whenever necessary. Always forward it to the end user.

Registration: The company and product names described in this manual are registered trademarks or the trademarks of their respective companies.

Effective May 2010
 Specifications are subject to change without notice.

© 2006 Mitsubishi Electric Corporation

Safety Precaution (Read these precautions before use.)
 This manual classifies the safety precautions into two categories:
 ⚠ DANGER and ⚠ CAUTION.

DANGER	Indicates that incorrect handling may cause hazardous conditions, resulting in death or severe injury.
CAUTION	Indicates that incorrect handling may cause hazardous conditions, resulting in medium or slight personal injury or physical damage.

Depending on the circumstances, procedures indicated by ⚠ CAUTION may also cause severe injury. It is important to follow all precautions for personal safety.

Associated Manuals

Manual name	Manual No.	Description
FX3U / FX3UC Series User's Manual - Analog Control Edition	JY997D16701 MODEL CODE: 09R619	Describes specifications for analog control and programming method for FX3U / FX3UC Series PLC.
FX3U/FX3UC Series Programming Manual - Basic & Applied Instruction Edition	JY997D16601 MODEL CODE: 09R517	Describes PLC programming for basic/applied instructions and devices.
FX3U Series User's Manual - Hardware Edition	JY997D16501 MODEL CODE: 09R516	Explains the FX3U Series PLC specifications for I/O, wiring, installation, and maintenance.
FX3UC Series User's Manual - Hardware Edition	JY997D28701 MODEL CODE: 09R519	Explains the FX3UC Series PLC specifications for I/O, wiring, installation, and maintenance.

How to obtain manuals
 For product manuals or documents, consult with the Mitsubishi Electric dealer from who you purchased your product.

Certification of UL, cUL standards
 The following product has UL and cUL certification.
UL, cUL File Number: E95239
Models: MELSEC FX3U series manufactured FX3U-4DA

Compliance with EC directive (CE Marking)
 This note does not guarantee that an entire mechanical module produced in accordance with the contents of this note will comply with the following standards. Compliance to EMC directive and LVD directive for the entire mechanical module should be checked by the user / manufacturer. For more details please contact the local Mitsubishi Electric sales site.

Requirement for Compliance with EMC directive
 The following products have shown compliance through direct testing (of the identified standards below) and design analysis (through the creation of a technical construction file) to the European Directive for Electromagnetic Compatibility (2004/108/EC) when used as directed by the appropriate documentation.

- Attention**
- This product is designed for use in industrial applications.
- Note**
- Manufactured by: Mitsubishi Electric Corporation, 2-7-3 Marunouchi, Chiyoda-ku, Tokyo, 100-8310 Japan
 - Manufactured at: Mitsubishi Electric Corporation Himeji Works, 640 Chiyoda-machi, Himeji, Hyogo, 670-8677 Japan
 - Authorized Representative in the European Community: Mitsubishi Electric Europe B.V., Gothaer Str. 8, 40880 Ratingen, Germany
- Type: Programmable Controller (Open Type Equipment)**
Models: MELSEC FX3U series manufactured from February 1st, 2006 FX3U-4DA
- | Standard | Remark |
|--|---|
| EN61131-2:2007 Programmable controllers - Equipment requirements and tests | Compliance with all relevant aspects of the standard.
EMI
• Radiated Emissions
• Mains Terminal Voltage Emissions
EMS
• RF immunity
• Fast Transients
• ESD
• Surge
• Conducted
• Power magnetic fields |

Caution for EC Directive
 The FX3U-4DA has been found to be compliant to the European standards in the aforesaid manual and directive. However, for the very best performance from what are in fact delicate measuring and controlled output device Mitsubishi Electric would like to make the following points;
 As analog devices are sensitive by nature, their use should be considered carefully. For users of proprietary cables (integral with sensors or actuators), these users should follow those manufacturers' installation requirements. Mitsubishi Electric recommends that shielded cables should be used. If NO other EMC protection is provided, then users may experience temporary loss or accuracy between ±10% in very heavy industrial areas. However, Mitsubishi Electric suggest that if adequate EMC precautions are followed for the users complete control system, users should expect accuracy as specified in this manual.

- Sensitive analog cable should not be laid in the same trunking or cable conduit as high voltage cabling. Where possible users should run analog cables separately.
- Good cable shielding should be used. Ground the shield of the twisted shielded cable at one point on the signal receiving side.
- Please use FX3U-4DA while installed in a shielded enclosure. For the details, refer to the following manual.
 → Refer to the FX3U Series User's Manual - Hardware Edition
 → Refer to the FX3UC Series User's Manual - Hardware Edition

Note for compliance with EN61131-2:2007
 General note on the use of the power supply cable.
 The FX3U-4DA unit requires that the cable used for power supply is 30m or less.

1. Outline
 The FX3U-4DA special function block for analog output converts digital values supplied from PLC into analog values (voltage, current) and outputs those analog values from its four output points.

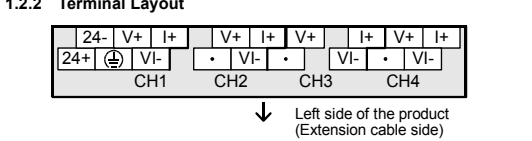
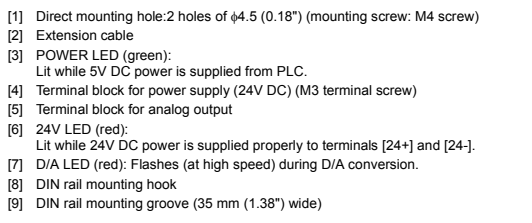
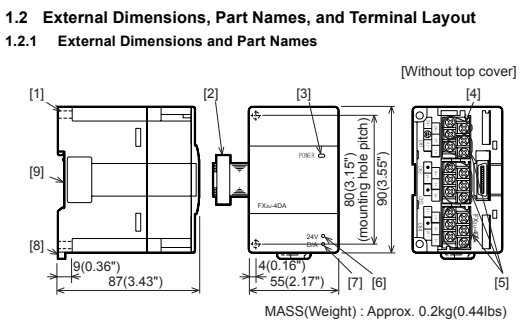
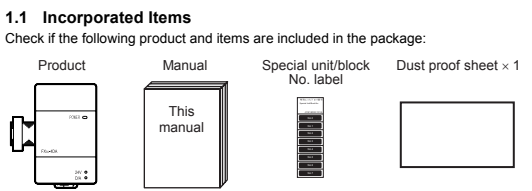

2.1 Arrangements
 The product connects on the right side of an PLC main unit or extension units/blocks (including special function units/blocks). For connection to FX3UC Series PLC or FX2NC Series PLC extension block, FX2NC-CNV-IF or FX3UC-1PS-5V is required. For further information of installation arrangements, refer to the following manual.
 → Refer to the FX3U Series User's Manual - Hardware Edition
 → Refer to the FX3UC Series User's Manual - Hardware Edition

The product is mounted by the following method.

- Direct mounting
- DIN rail mounting

2.1.1 Direct Mounting
 The product can be mounted with M4 screws by using the direct mounting holes. Refer to the External Dimensions (section 1.2) for the product's mounting hole pitch information. An interval space between each unit of 1 to 2 mm (0.04" to 0.08") is necessary. For further information of direct installation, also refer to the following manual.
 → Refer to the FX3U Series User's Manual - Hardware Edition
 → Refer to the FX3UC Series User's Manual - Hardware Edition

2.1.2 DIN Rail Mounting
 The product can be mounted on a DIN rail (DIN46227, 35mm width).
 1) Fit the upper edge of the DIN rail mounting groove (fig. A) onto the DIN rail.
 2) Press the product against the DIN rail.

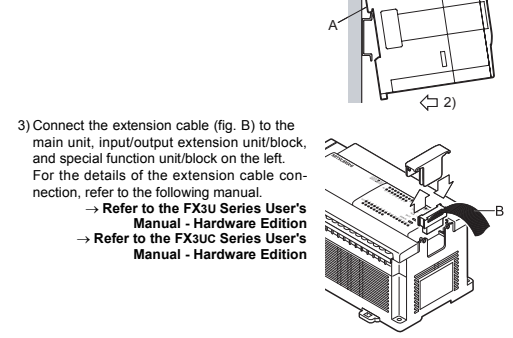

3. Wiring

WIRING PRECAUTIONS ⚠ DANGER

- Make sure to cut off all phases of the power supply externally before attempting installation or wiring work. Failure to do so may cause electric shock or damage to the product.

WIRING PRECAUTIONS ⚠ CAUTION

- Make sure to observe the following precautions in order to prevent any damage to the machinery or accidents due to abnormal data written to the PLC under the influence of noise:
 - Do not bundle the main circuit line together with or lay it close to the main circuit, high-voltage line or load line. Otherwise, noise disturbance and/or surge induction are likely to take place. As a guideline, lay the control line at least 100mm (3.94") or more away from the main circuit or high-voltage lines.
 - Ground the shield wire or shield of the shielded cable at one point on the PLC. However, do not use common grounding with heavy electrical systems.
- Make sure to properly wire to the terminal blocks in accordance with the following precautions. Failure to do so may cause electric shock, a short-circuit, wire breakage, or damage to the product.
 - The disposal size of the cable end should follow the dimensions described in this manual.
 - Tightening torque should be between 0.5 and 0.8 N·m.

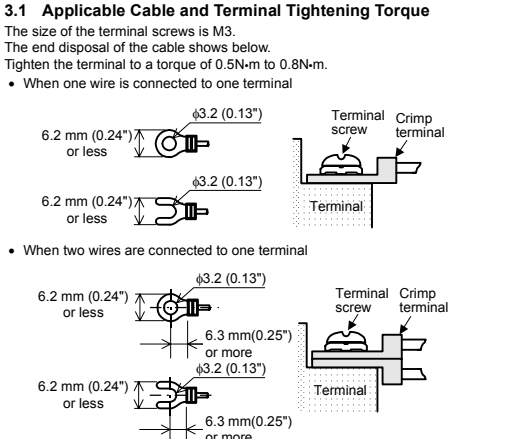

- *1 For FX3U Series PLC (AC power type), the 24V DC service power supply is also available.
- *2 Leave the [4] terminal unconnected.
- *3 Use a 2-core twisted shield wire for analog output line, and separate it from other power lines or inductive lines.
- *4 If there is ripple or noise in the output voltage, connect a capacitor of approximately 0.1 to 0.47 μF 25 V in the vicinity of the signal receiving side.
- *5 Ground the shielded wire at one point on the signal receiving side.

3.4 Grounding
 Grounding should be performed as stated below.

- The grounding resistance should be 100Ω or less.
- Independent grounding should be performed for best results. When independent grounding is not performed, perform "shared grounding" of the following figure.
 → For details, refer to the FX3U Series User's Manual - Hardware Edition.
 → For details, refer to the FX3UC Series User's Manual - Hardware Edition.

- The grounding wire size should be AWG 14 (2 mm²).
- The grounding point should be close to the PLC, and all grounding wire should be as short as possible.

4. Specifications

STARTUP AND MAINTENANCE PRECAUTIONS ⚠ CAUTION

- Do not disassemble or modify the PLC. Doing so may cause fire, equipment failures, or malfunctions. * For repair, contact your local Mitsubishi Electric distributor.
- Do not drop the product or exert strong impact to it. Doing so may cause damage.

DISPOSAL PRECAUTIONS ⚠ CAUTION

- Please contact a certified electronic waste disposal company for the environmentally safe recycling and disposal of your device.

TRANSPORT AND STORAGE PRECAUTIONS ⚠ CAUTION

- The product is a precision instrument. During transportation, avoid any impacts. After transportation, verify the operations of the product.

4.1 Applicable PLC

Model name	Applicability
FX3U Series PLC	Ver. 2.20 or later (from first production) Up to 8 blocks can be extended
FX3UC Series PLC ¹	Ver. 1.30 or later (from the production manufactured in August, 2004 with SER No. 48□□□□) Up to 8 blocks can be extended ²

The version number can be checked by monitoring D8001 as the last three digits indicate.

- *1 An FX2NC-CNV-IF or FX3UC-1PS-5V is necessary to connect the 20SSC-H with the FX3UC PLC.
- *2 Up to 7 units can be connected to the FX3UC-32MT-LT PLC.

4.2 General Specifications
 For the general specifications other than the following, refer to the manual of the PLC main unit. The items other than the following are equivalent to those of the PLC main unit.
 → Refer to the FX3U Series User's Manual - Hardware Edition.
 → Refer to the FX3UC Series User's Manual - Hardware Edition.

Item	Specification
Dielectric withstand voltage	500V AC for one minute Conforming to JEM-1021 between all terminals and ground terminal of PLC main unit
Insulation resistance	5MΩ or more by 500V DC megger

4.3 Power Supply Specifications

Item	Specification
D/A conversion circuit driving power	24V DC ±10%, 160mA (24V DC power is supplied from the power connector.)
CPU driving power	5V DC, 120mA (5V DC power is supplied from the internal power supply of main unit.)

4.4 Performance Specifications

Item	Description	
	Voltage output	Current output
Analog output range	-10 to +10V DC (External load: 1kΩ to 1MΩ)	0 to 20mA, 4 to 20mA DC (External load: 500 Ω or less)
Offset ¹	-10 to +9V ²	0 to 17mA ³
Gain ¹	-9 to +10V ²	3 to 30mA ³
Digital input	With sign, 16bits, binary	15bits, binary
Resolution	0.32mV (20V/64000)	0.63μA (20mA/32000)
Total accuracy	<ul style="list-style-type: none"> ±0.3% (±60mV) for full scale of 20V (when ambient temperature is 25°C±5°C) ±0.5% (±100mV) for full scale of 20V (when ambient temperature is 0°C to 55°C) 	<ul style="list-style-type: none"> ±0.3% (±60μA) for full scale of 20mA (when ambient temperature is 25°C±5°C) ±0.5% (±100μA) for full scale of 20mA (when ambient temperature is 0°C to 55°C)
A/D conversion time	1ms (The number of selected channels will not affect this value.)	

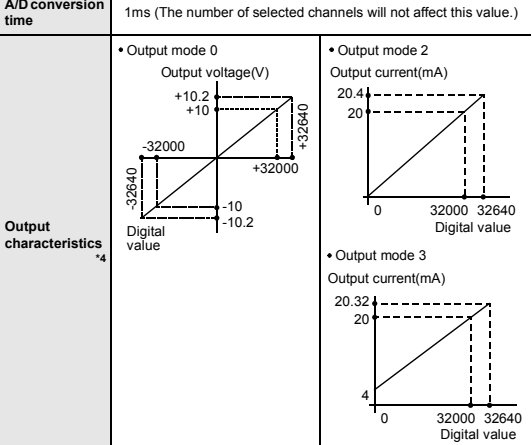

Insulation method

- The photo-coupler insulates the analog output area from the PLC.
- The DC-DC converter insulates the analog output area from the power supply unit.
- Channels are not insulated from each other.

Occupied points
 8 point (Count either the input or output points of the PLC.)

- *1 Change the offset and gain values to change the output characteristics. However, the resolution doesn't change even when the offset and gain values change. When analog value (mV, μA) specification is enabled in the output mode 1 or 4, the offset value and the gain value don't change.
- *2 The offset and the gain should satisfy the following condition:
 1 V ≤ (Gain - Offset) ≤ 10 V
- *3 The offset and the gain should satisfy the following condition:
 3 mA ≤ (Gain - Offset) ≤ 30 mA
- *4 The output characteristics vary depending on the output mode to be used. For the details of the output characteristics, refer to the following manual.
 → Refer to the FX3U / FX3UC Series User's Manual - Analog Control Edition

4.5 Output characteristics

The output characteristics in each output mode are as follows.

Output mode	Output mode	Analog output range	Digital input range
0	Voltage output mode	-10 to +10V	-32000 to +32000
1	Voltage output analog value mV specification mode	-10 to +10V	-10000 to +10000
2	Current output mode	0 to 20mA	0 to 32000
3	Current output mode	4 to 20mA	0 to 32000
4	Current output analog value μA specification mode	0 to 20mA	0 to 20000

This manual confers no industrial property rights or any rights of any other kind, nor does it confer any patent licenses. Mitsubishi Electric Corporation cannot be held responsible for any problems involving industrial property rights which may occur as a result of using the contents noted in this manual.

Warranty
 Mitsubishi will not be held liable for damage caused by factors found not to be the cause of Mitsubishi; opportunity loss or lost profits caused by faults in the Mitsubishi products; damage, secondary damage, accident compensation caused by special factors unpredictable by Mitsubishi; damages to products other than Mitsubishi products; and to other duties.

For safe use

- This product has been manufactured as a general-purpose part for general industries, and has not been designed or manufactured to be incorporated in a device or system used in purposes related to human life.
- Before using the product for special purposes such as nuclear power, electric power, aerospace, medicine or passenger movement vehicles, consult with Mitsubishi Electric.
- This product has been manufactured under strict quality control. However when installing the product where major accidents or losses could occur if the product fails, install appropriate backup or failsafe functions in the system.